

DIGITAL SIGNAGE
PRO SERIES



Modular Design – Limitless possibilities. Strong ties with major AV distributors and installers as well as industry leaders enable us to develop head-end system specific digital signage solutions to the market needs of your business. We strive to always create simple and intuitive wall mounting solutions for digital signage display setups as well as in-room installations. Our aim is to consistently find ways to improve on our digital signage product offering. Maybe it's time for your business to discover a new level of refinement with our Pro Series signage solutions.

 Designed and
engineered in
Sweden

PRO SERIES Model name structure

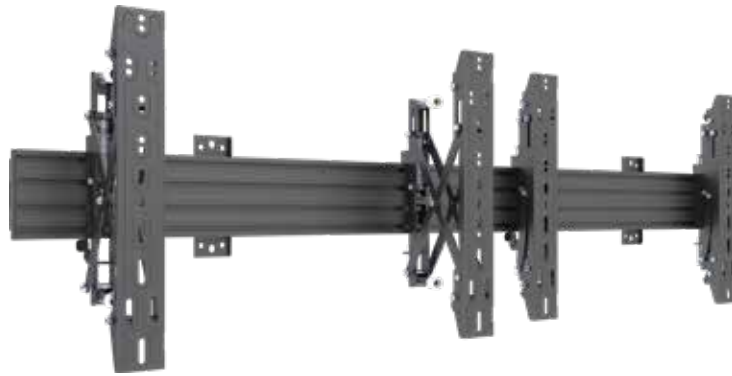

MB 2 X1U P

Multibrackets

2 rows

x1 units

Portrait



Truly
Modular design

Quick
Swift installation

Powerful
Rigorously tested

Experience
Sits in the details

Creativity
Empower creativity

Solutions
Vast possibilities

DIGITAL SIGNAGE - PRO SERIES

Introduction	6 - 7
Ceiling mounts	8 - 29
Menu Boards	30 - 37
Floor to Ceiling	38 - 53
Camera Ceiling Mounts	54 - 57
Floor to wall	58 - 59
The Wallmounts	60 - 77
Column	78 - 79
Outdoor Solutions	80 - 83
The Rail + Brackets	84 - 85
From Wall & Wall to Wall	86 - 87
Collaboration	88 - 94
Floorstands	96 - 115
Videowalls	116 - 119
Wire	120 - 121
Monitor stands	122 - 123
Enclosures	124 - 141
LED	142 - 151
Customized	152 - 165
Control rooms	166 - 167
Parts	168 - 177

PRO SERIES

Digital Signage

Wide range of configurations

Pro Series is a Digital Signage product series, that can be configured to Ceiling Mounts, Floor to Ceiling Mounts, Menu Boards or Wallmounts. With its modular construction install-

ers have vast possibilities to change, update and reconfigure its design if ideas change. Over time the Pro Series installation can be combined into a wide range of new configurations.

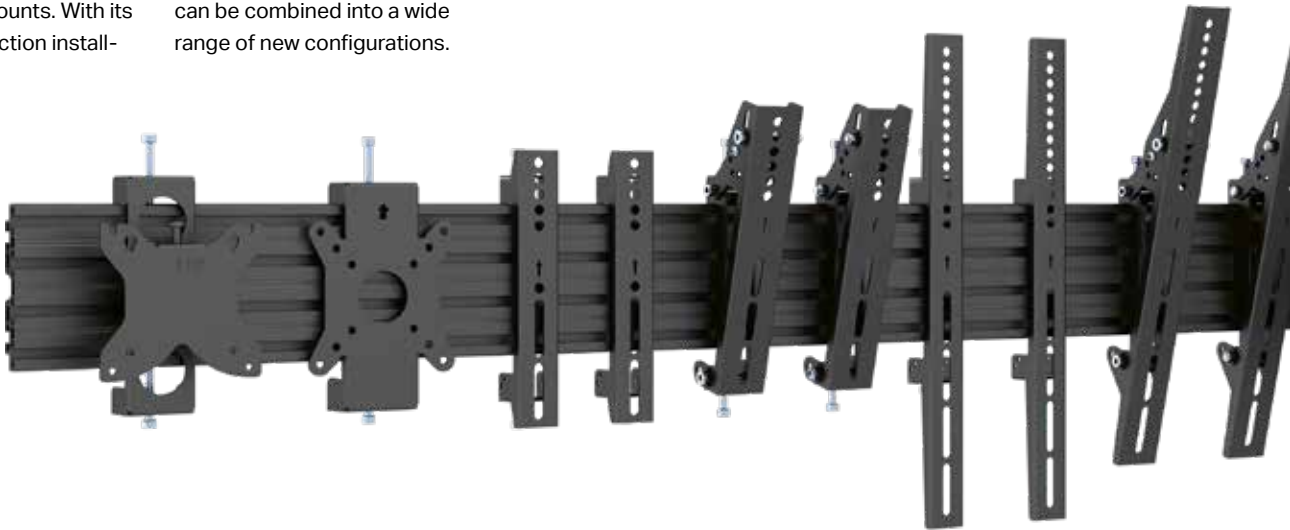

Precision leveling

Each mounting bracket allows for micro height adjustments to be made to ensure your screens are levelled and perfectly aligned.

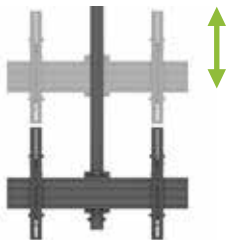

Extendable Height

The extendable poles allows you to position the center of the screen mounting plate no any height limitation. For tighter spaces, just with single pole to achieve a distance of 80cm.



Easy Tilt

Tilt the mounting brackets 5°, 10° or 15° forward to improve line-of-sight while maintaining alignment between your screens. To compensate for potential lean, the brackets can also be angled up to 6° backward.



Modular Design

Available in a wide range of models, Digital Signage ceiling mounts support single to 18 screens weighing up to 30kg each. Their modular design allows for additional extrusions to be added to accommodate screens with wider VESA patterns, or to connect multiple units together.



Selected models are TUV approved

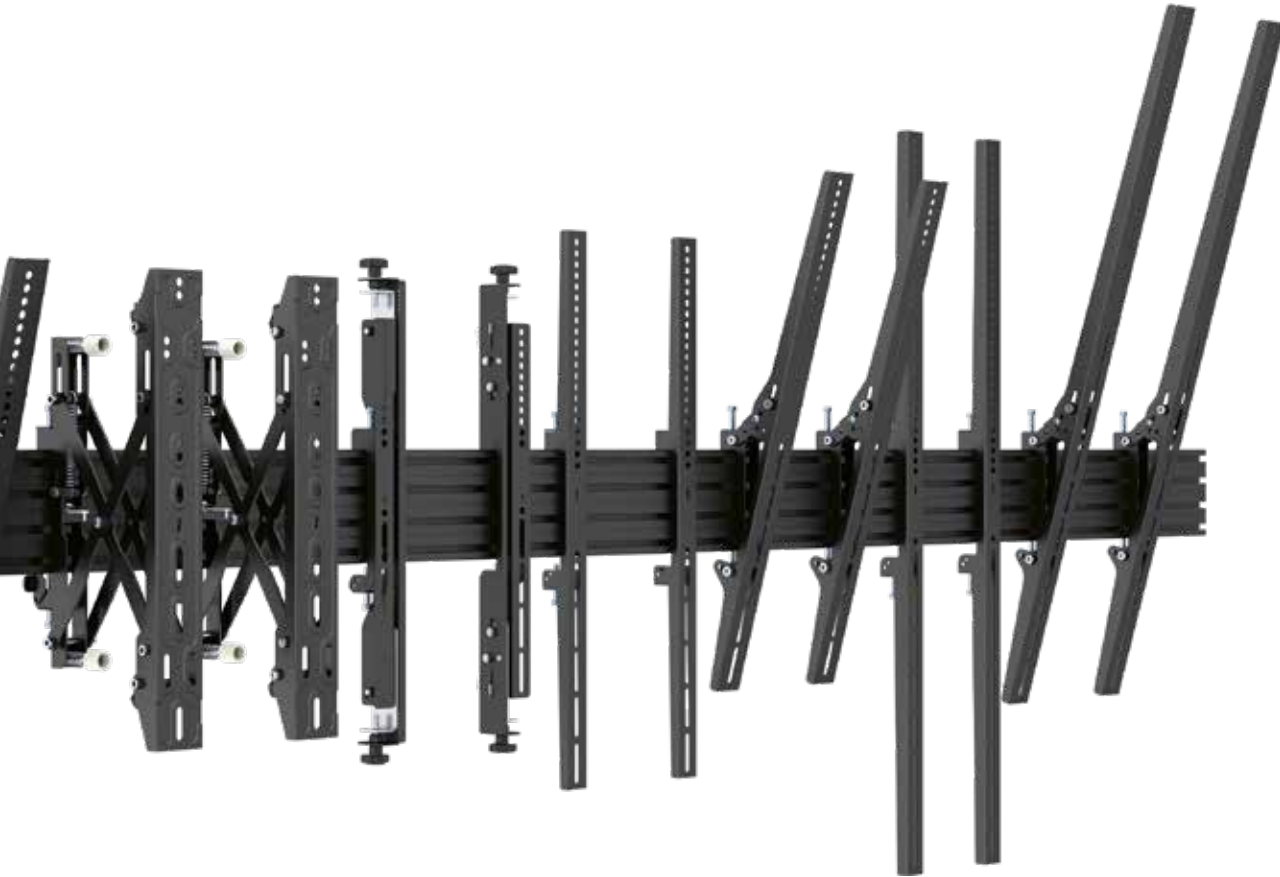

Cable Management

The extension pole's hollow core provides an unobstructed path to route your cables, while an opening in the mounting plate allows them to continue through the ceiling for a truly professional setup.



Easy Installation

To reduce strain, Digital Signage Mounts use lightweight ceiling plates that are installed independent of the rest of the mounting system. Simply slide each extension pole into place and secure it to complete the installation.



Flexible floor mounting

Designed to service a variety of freestanding solutions Pro Series can cater most ideas; wheelbased, floorbased or bolted directly to the floor. Ideal for the heavy duty multi-screen setups. Aesthetically pleasing with premium quality finish.



Displays or LED panels

As Multibrackets Pro Series line up is a truly universal mounting system it makes it compatible with various LED panels. Samsung, LG, Philips and other brand names can use Pro Series set ups in most formats one would need; Ceilingmounted, Wallmounted, Wheelbased, Freestanding and bolted down.



Pro Series MBC4U in a Volvo Showroom in Stockholm.

Pro Series Ceiling mounted solutions

Great for installers and digital signage installations. Our ceiling mounted solutions make it possible to construct single, dual or video walls in prominent locations where

walls aren't available. Comes in a variety of arrangements. Our Ceilingmounts are designed to deliver a simple solution for any digital signage installations involving multiple commercial

displays 32"-100". Perfect for many commercial installations the space saving design ensures the very best installer experience.

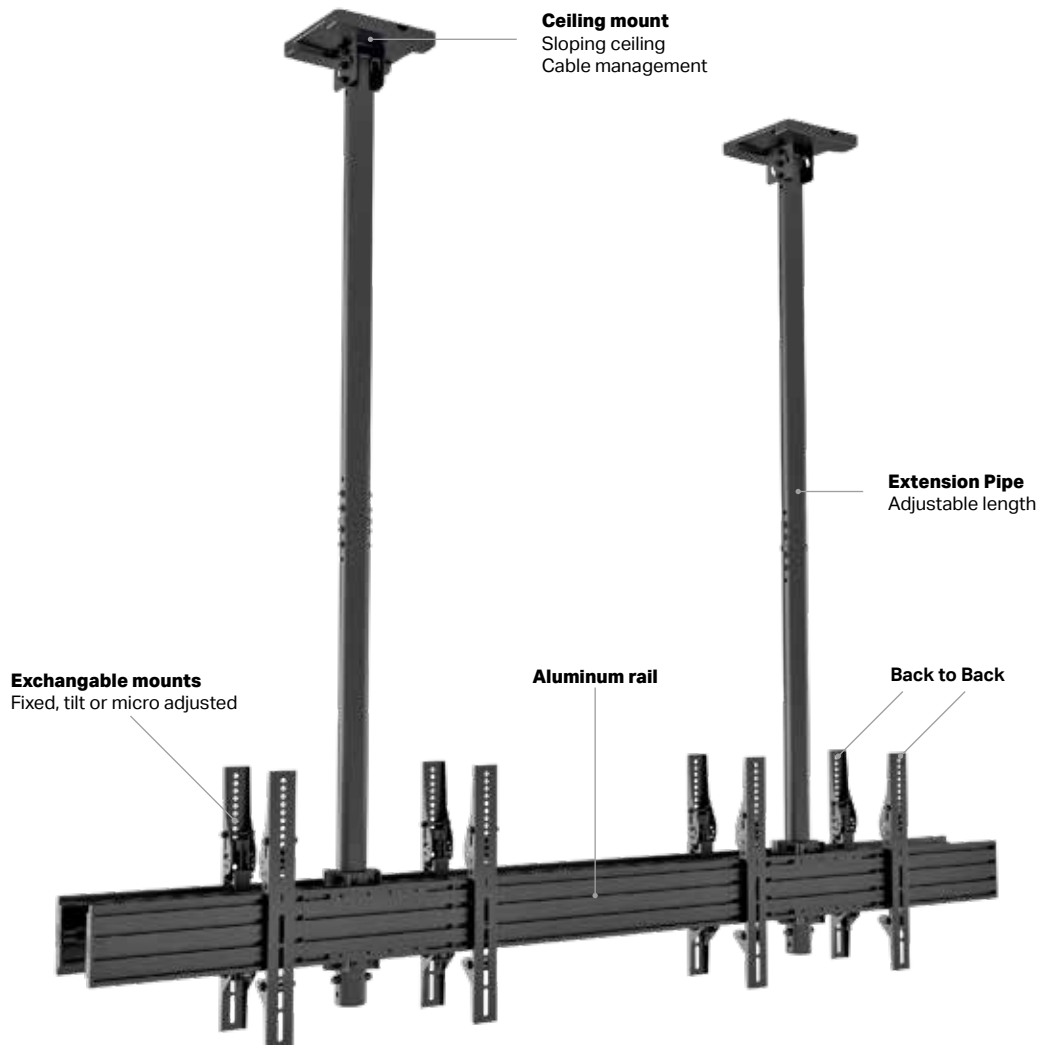

Back to back optional

Cable management

Landscape and portrait

Max load tested 5x

Micro adjustable

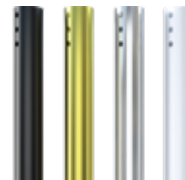

Starting from **1CU** to **9CUB2B**, using a total of 18 screens.

Multiple color options



MBC1U White VESA 200



MBC1UX2 VESA 200



MBC2X1U VESA 200



MBC3X1U VESA 200



	MBC1U White VESA 200	MBC1UX2 VESA 200	MBC2X1U VESA 200	MBC3X1U VESA 200
Model:	MBC1U White VESA 200	MBC1UX2 VESA 200	MBC2X1U VESA 200	MBC3X1U VESA 200
Recommended screen size:	24" - 42"	24" - 42"	30" - 42"	30" - 42"
VESA & Non-VESA Fixings:	VESA 200, 20cm	VESA 200, 20cm	VESA 200, 20cm	VESA 200, 20cm
EAN:	735002273 8669	735002273 7884	735010521 2253	735010521 2260
Max load:	30kg	30kg (Per screen)	30kg (Per screen)	30kg (Per screen)
Bracket type:	Tilt (Fixed optional)	Tilt (Fixed optional)	Tilt (Fixed optional)	Tilt (Fixed optional)
Landscape / portrait:	Yes	Yes	Yes	Portrait
Pole length:	80 cm up to 150 cm	80 cm up to 150 cm	80 cm up to 150 cm	80 cm up to 150 cm
Colour (VESA arms):	Black	Black	Black	Black
Colour (Horizontal rail):	Black (Silver optional)	Black (Silver optional)	Black (Silver optional)	Black (Silver optional)
Colour (Poles & ceiling mount):	Black	Black	Black	Black
Warranty:	5 years	5 years	5 years	5 years
Accessories:	Cover plates	Cover plates	Cover plates	Cover plates

MBC4X1U VESA 200



MBC5X1UP VESA 200



MBC1U VESA 300



MBC2X1U VESA 300



	MBC2X1U VESA 200	MBC3X1U VESA 200	MBC1U VESA 300	MBC2X1U VESA 300
Recommended screen size:	30" - 42"	30" - 42"	32" - 50"	32" - 50"
VESA & Non-VESA Fixings:	VESA 200, 20cm	VESA 200, 20cm	VESA 300, 30cm	VESA 300, 30cm
EAN:	735010521 2277	735010521 5568	735002273 7891	735002273 7907
Max load:	30kg (Per screen)	30kg (Per screen)	30kg (Per screen)	30kg (Per screen)
Bracket type:	Tilt (Fixed optional)	Tilt (Fixed optional)	Fixed (Tilt optional)	Tilt (Fixed optional)
Landscape / portrait:	Yes	Yes	Yes	Yes
Pole length:	80 cm up to 150 cm	80 cm up to 150 cm	80 cm up to 150 cm	80 cm up to 150 cm
Colour (VESA arms):	Black	Black	Black	Black
Colour (Horizontal rail):	Black (Silver optional)	Black (Silver optional)	Black (Silver optional)	Black (Silver optional)
Colour (Poles & ceiling mount):	Black	Black	Black	Black
Warranty:	5 years	5 years	5 years	5 years
Accessories:	Cover plates	Cover plates	Cover plates	Cover plates

MBC3X1U VESA 300



MBC4X1U VESA 300



MBC4X1U VESA Fixed 300



MBC5X1U VESA 300



	Model: MBC3X1U VESA 300	MBC4X1U VESA 300	MBC4X1U VESA Fixed 300	MBC5X1U VESA 300
Recommended screen size:	32" - 50"	32" - 50"	32" - 50"	32" - 50"
VESA & Non-VESA Fixings:	VESA 300, 30cm	VESA 300, 30cm	VESA 300, 30cm	VESA 300, 30cm
EAN:	735002273 7914	735010521 6053	735010521 6220	735002273 7938
Max load:	30kg	30kg (Per screen)	30kg (Per screen)	30kg (Per screen)
Bracket type:	Tilt (Fixed optional)	Tilt (Fixed optional)	Tilt (Fixed optional)	Tilt (Fixed optional)
Landscape / portrait:	Yes	Yes	Yes	Yes
Pole length:	80 cm up to 150 cm	80 cm up to 150 cm	80 cm up to 150 cm	80 cm up to 150 cm
Colour (VESA arms):	Black	Black	Black	Black
Colour (Horizontal rail):	Black (Silver optional)	Black (Silver optional)	Black (Silver optional)	Black (Silver optional)
Colour (Poles & ceiling mount):	Black	Black	Black	Black
Warranty:	5 years	5 years	5 years	5 years
Accessories:	Cover plates	Cover plates	Cover plates	Cover plates

MBC1F VESA 200



MBC1F VESA 400



MBC1U VESA 200



MBC1U VESA 400

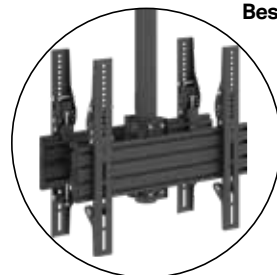

Bestseller!

MBC1UX2 VESA 400
Back to Back
EAN: 7350073738892

	MBC1F VESA 200	MBC1F VESA 400	MBC1U VESA 200	MBC1U VESA 400
Model:	MBC1F VESA 200	MBC1F VESA 400	MBC1U VESA 200	MBC1U VESA 400
Recommended screen size:	17" - 42"	17" - 42"	24" - 42"	17" - 42"
VESA & Non-VESA Fixings:	VESA 200, 20cm	VESA 400, 40cm	VESA 200, 20cm	VESA 400, 40cm
EAN:	735007373 6416	735007373 6423	735007373 3897	735007373 8885
Max load:	30kg (Per screen)	30kg (Per screen)	30kg (Per screen)	30kg (Per screen)
Bracket type:	Tilt	Tilt	Tilt (Fixed optional)	Tilt (Fixed optional)
Landscape / portrait:	Yes	Yes	Yes	Yes
Pole length:	80 cm up to 150 cm	80 cm up to 150 cm	80 cm up to 150 cm	80 cm up to 150 cm
Colour (VESA arms):	Black	Black	Black	Black
Colour (Horizontal rail):	Black (Silver optional)	Black (Silver optional)	Black (Silver optional)	Black (Silver optional)
Colour (Poles & ceiling mount):	Black	Black	Black	Black
Warranty:	5 years	5 years	5 years	5 years
Accessories:	Cover plates	Cover plates	Cover plates	Cover plates

MBC1U



MBC1UX2



MBC2X1U



MBC2X1U2



Find 100+ models of Pro Series online

	MBC1U	MBC1UX2	MBC2X1U	MBC2X1U2
Model:	MBC1U	MBC1UX2	MBC2X1U	MBC2X1U2
Recommended screen size:	40" - 65"	40" - 65"	40" - 65"	40" - 65"
VESA & Non-VESA Fixings:	VESA 600x400, 40cm	VESA 600x400, 40cm	VESA 400, 40cm	VESA 400, 40cm
EAN:	735007373 3446	735007373 3453	735007373 3460	735007373 3491
Max load:	30kg (Per screen)	30kg (Per screen)	30kg (Per screen)	30kg (Per screen)
Bracket type:	Tilt (Fixed optional)	Tilt (Fixed optional)	Tilt (Fixed optional)	Tilt (Fixed optional)
Landscape / portrait:	Yes	Yes	Yes	Yes
Pole length:	80 cm up to 150 cm	80 cm up to 150 cm	80 cm up to 150 cm	80 cm up to 150 cm
Colour (VESA arms):	Black	Black	Black	Black
Colour (Horizontal rail):	Black (Silver optional)	Black (Silver optional)	Black (Silver optional)	Black (Silver optional)
Colour (Poles & ceiling mount):	Black	Black	Black	Black
Warranty:	5 years	5 years	5 years	5 years
Accessories:	Cover plates	Cover plates	Cover plates	Cover plates

MBC1U White VESA 400



MBC1U2 White VESA 400



MBC1U White



MBC1USD 600 White



	MBC1U White VESA 400	MBC1UX2 White VESA 400	MBC1U White	MBC1USD 600 White
Recommended screen size:	40" - 65"	40" - 65"	40" - 75"	40" - 100"
VESA & Non-VESA Fixings:	VESA 400x400mm	VESA 400x400mm	VESA 600x400mm	VESA 600x400mm
EAN:	735002273 8638	735002273 8652	735002273 8645	735010521 7289
Max load:	30kg	30kg (Per screen)	12kg	12kg
Bracket type:	Tilt (Fixed optional)	Tilt (Fixed optional)	Fixed (Tilt optional)	Tilt (Fixed optional)
Landscape / portrait:	Portrait	Yes	Yes	Yes
Pole length:	80 cm up to 150 cm	80 cm up to 150 cm	80 cm up to 150 cm	80 cm up to 150 cm
Colour (VESA arms):	Black	Black	Black	Black
Colour (Horizontal rail):	Black (Silver optional)	Black (Silver optional)	Black (Silver optional)	Black (Silver optional)
Colour (Poles & ceiling mount):	White	White	White	White
Warranty:	5 years	5 years	5 years	5 years
Accessories:	Cover plates	Cover plates	Cover plates	Cover plates

MBC3X1U



MBC3X1U2

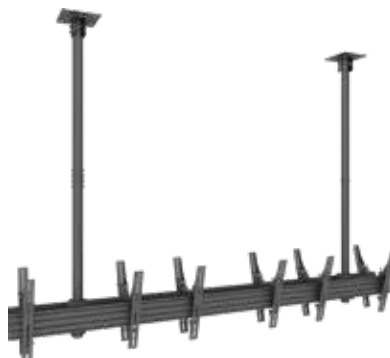

MBC4X1U



MBC4X1U2

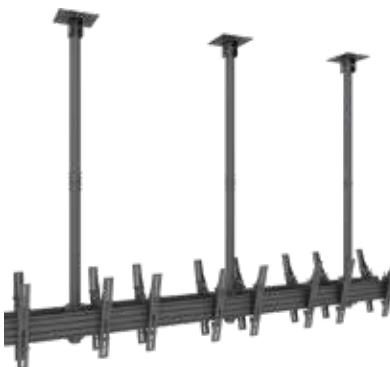

	MBC3X1U	MBC3X1U2	MBC4X1U	MBC4X1U2
Model:	MBC3X1U	MBC3X1U2	MBC4X1U	MBC4X1U2
Recommended screen size:	40" - 65"	40" - 65"	40" - 65"	40" - 65"
VESA & Non-VESA Fixings:	VESA 400, 40cm	VESA 400, 40cm	VESA 400, 40cm	VESA 400, 40cm
EAN:	735007373 3477	735007373 3507	735007373 3484	735007373 3514
Max load:	30kg (Per screen)	30kg (Per screen)	30kg (Per screen)	30kg (Per screen)
Bracket type:	Tilt (Fixed optional)	Tilt (Fixed optional)	Tilt (Fixed optional)	Tilt (Fixed optional)
Landscape / portrait:	Yes	Yes	Yes	Yes
Pole length:	80 cm up to 300 cm	80 cm up to 300 cm	80 cm up to 300 cm	80 cm up to 300 cm
Colour (VESA arms):	Black	Black	Black	Black
Colour (Horizontal rail):	Black (Silver optional)	Black (Silver optional)	Black (Silver optional)	Black (Silver optional)
Colour (Poles & ceiling mount):	Black	Black	Black	Black
Warranty:	5 years	5 years	5 years	5 years
Accessories:	Cover plates	--	Cover plates	--

MBC2U



MBC2U2



MBC2X2U



MBC2X2U2

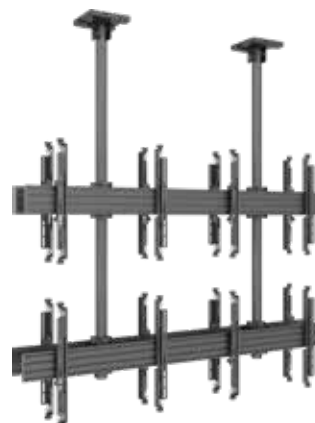

	MBC2U	MBC2U2	MBC2X2U	MBC2X2U2
Model:	MBC2U	MBC2U2	MBC2X2U	MBC2X2U2
Recommended screen size:	40" - 65"	40" - 65"	40" - 65"	46" - 65"
VESA & Non-VESA Fixings:	VESA 400, 40cm	VESA 400, 40cm	VESA 400, 40cm	VESA 400, 40cm
EAN:	735007373 3545	735007373 3583	735007373 3552	735007373 3590
Max load:	30kg (Per screen)	30kg (Per screen)	30kg (Per screen)	30kg (Per screen)
Bracket type:	Fixed	Fixed	Micro-Adjustable Arms	Micro-Adjustable Arms
Landscape / portrait:	Yes	Yes	Yes	Yes
Pole length:	80 cm up to 150 cm	80 cm up to 150 cm	80 cm up to 300 cm	80 cm up to 300 cm
Colour (VESA arms):	Black	Black	Black	Black
Colour (Horizontal rail):	Black (Silver optional)	Black (Silver optional)	Black (Silver optional)	Black (Silver optional)
Colour (Poles & ceiling mount):	Black	Black	Black	Black
Warranty:	5 years	5 years	5 years	5 years
Accessories:	Cover plates	--	Cover plates	Cover plates

MBC3X2U



MBC3X2U2

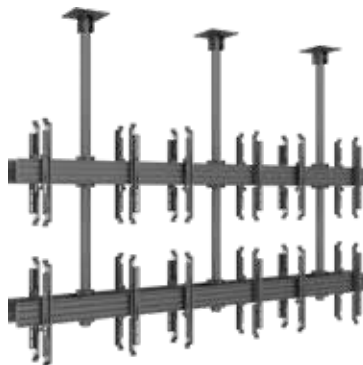

MBC3X3U



	MBC3X2U	MBC3X2U2	MBC3X3U
Model:	MBC3X2U	MBC3X2U2	MBC3X3U
Recommended screen size:	40" - 65"	40" - 65"	40" - 65"
VESA & Non-VESA Fixings:	VESA 400, 40cm	VESA 400, 40cm	VESA 400, 40cm
EAN:	735007373 3569	735007373 3606	735007373 3576
Max load:	30kg (Per screen)	30kg (Per screen)	30kg (Per screen)
Bracket type:	Tilt	Tilt	Tilt (Fixed optional)
Landscape / portrait:	Yes	Yes	Yes
Pole length:	80 cm up to 300 cm	80 cm up to 300 cm	80 cm up to 300 cm
Colour (VESA arms):	Black	Black	Black
Colour (Horizontal rail):	Black (Silver optional)	Black (Silver optional)	Black (Silver optional)
Colour (Poles & ceiling mount):	Black	Black	Black
Warranty:	5 years	5 years	5 years
Accessories:	Cover plates	--	--

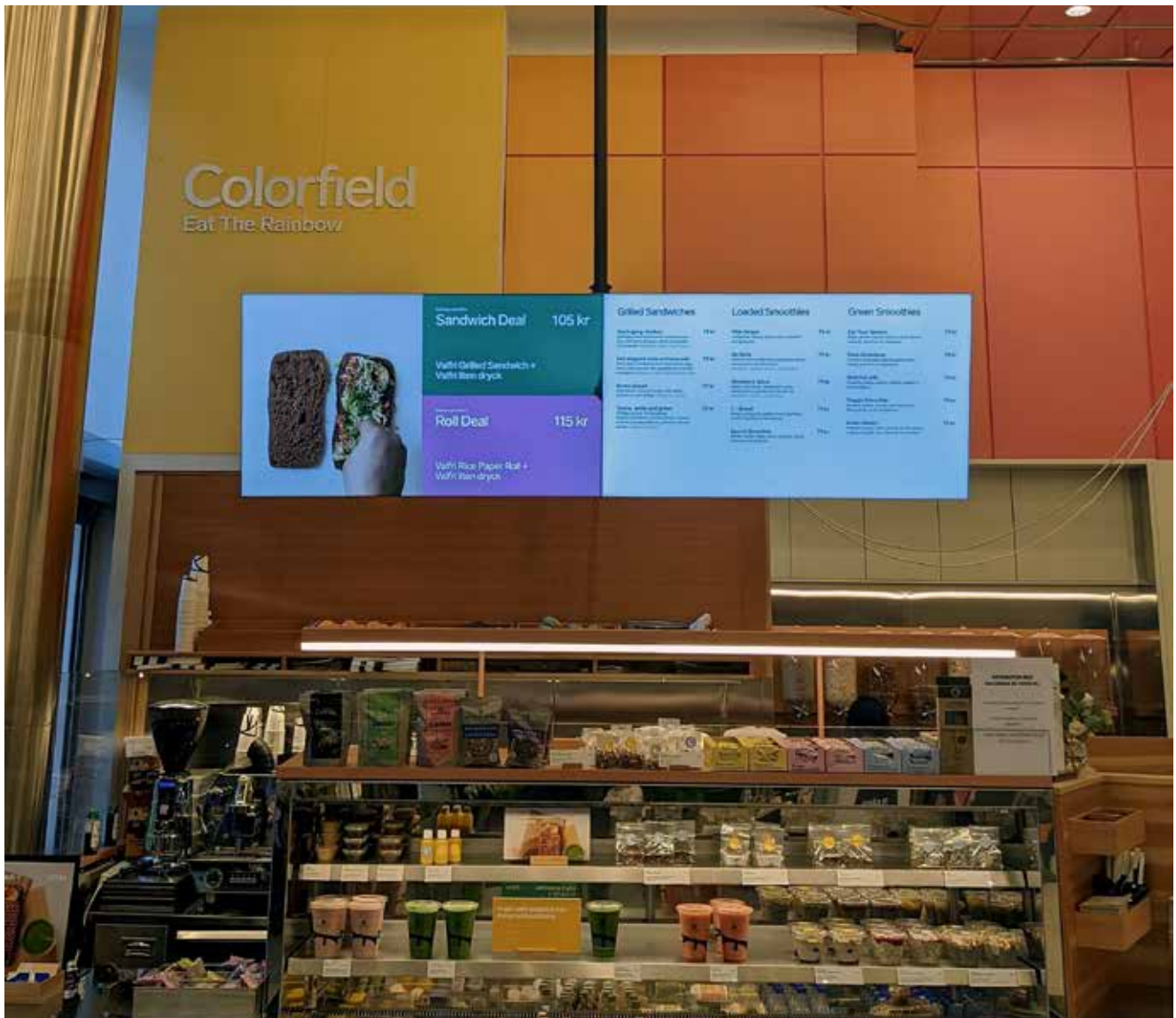





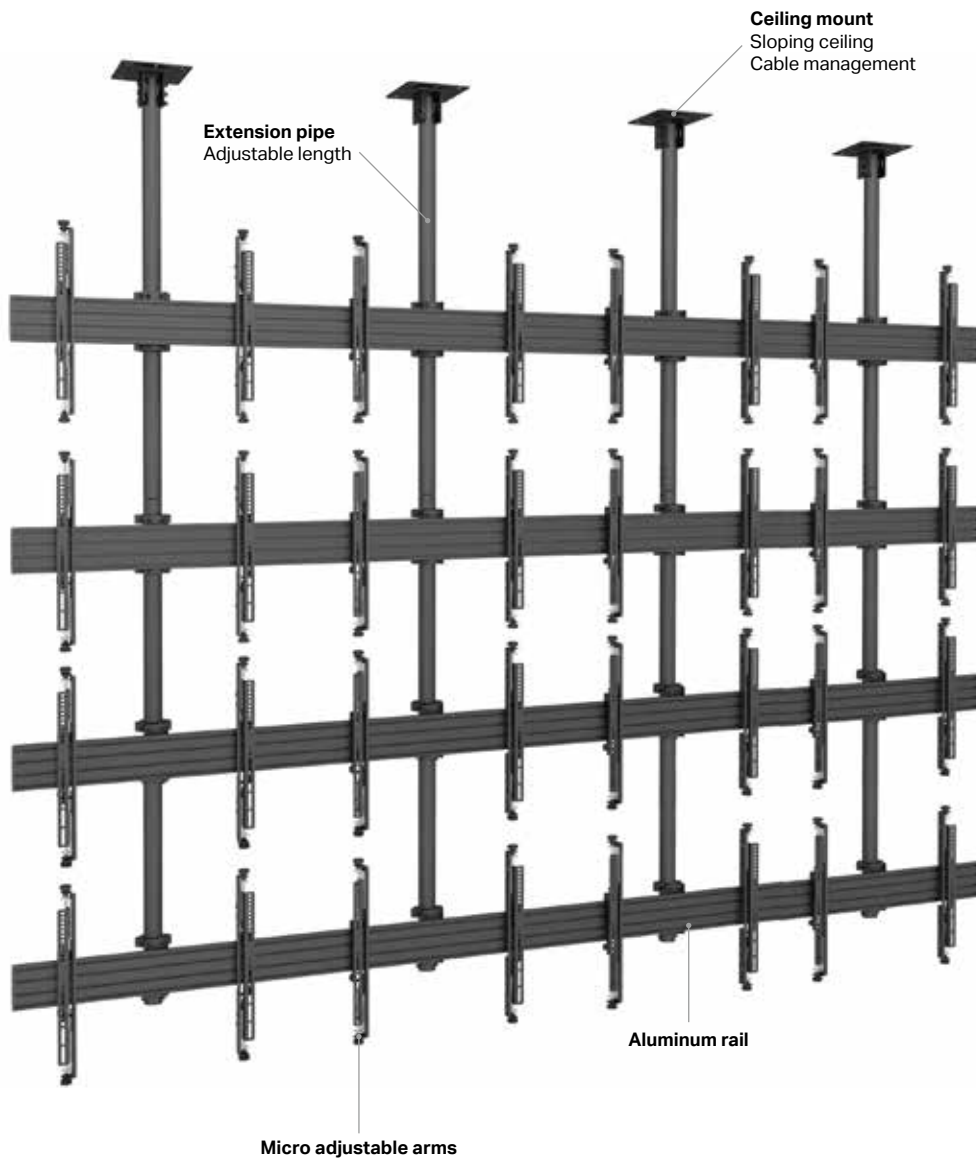

Pro Series creates magic results

Highlights

- A professional, flexible and modular product
- Includes VESA adapters for compatibility up to VESA 900
- Integrated cable management throughout the entire solution
- Power click install for an easy, fast and safe installation
- Ceiling plate included
- Portrait or landscape position of screen possible
- Hardware kit included

MBC4X4





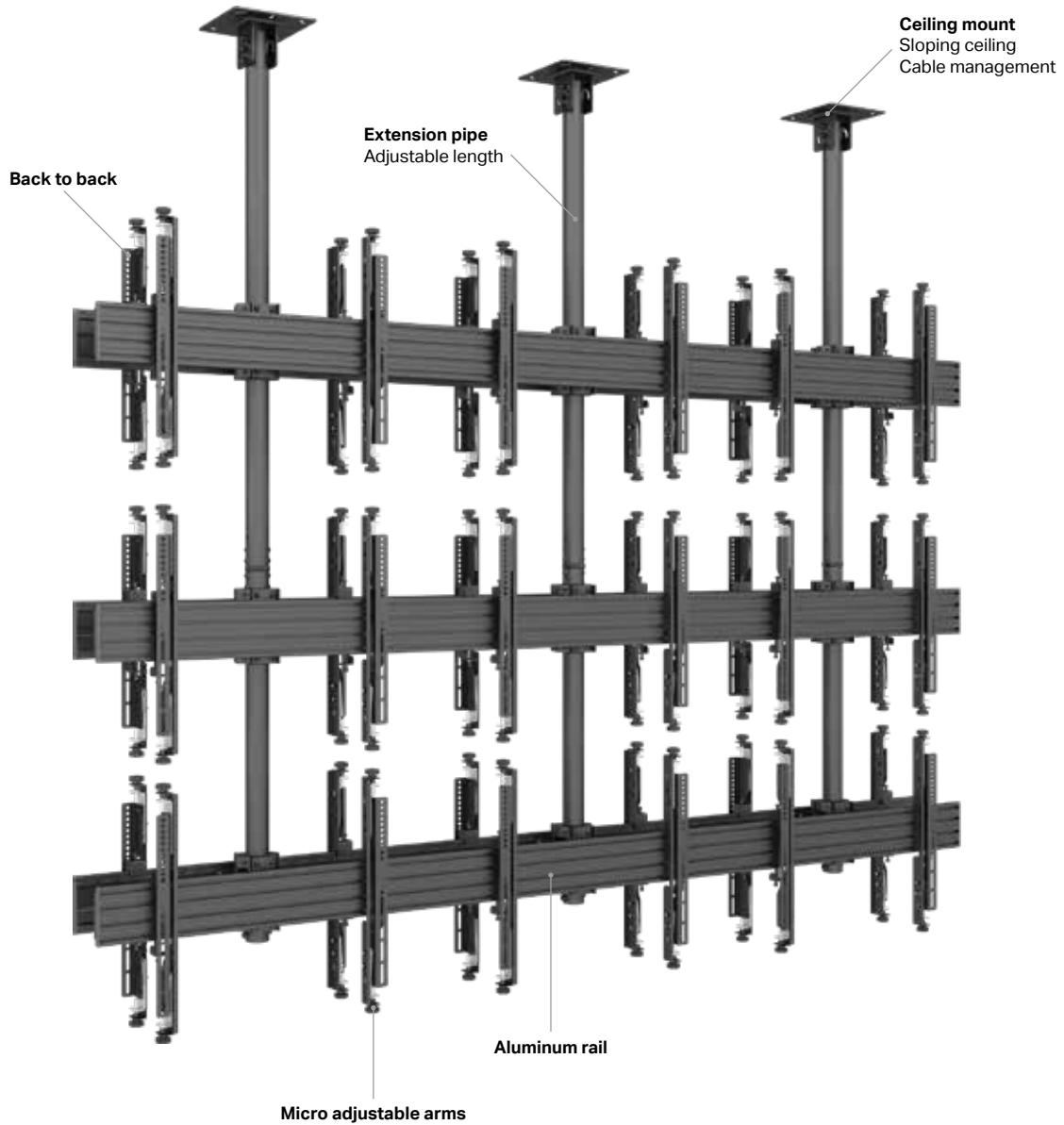

- 
 Back to back optional
- 
 Cable management
- 
 Landscape and portrait
- 
 Max load tested 5x
- 
 Micro adjustable

Model:	MBC4X4
Recommended screen size:	46" - 65"
VESA & Non-VESA Fixings:	VESA 400, 40cm
EAN:	735007373 7864
Max load:	30kg (Per screen)
Bracket type:	Micro-Adjustable Arms
Landscape / portrait:	Yes
Pole length:	80 cm up to 300 cm
Colour (VESA arms):	Black
Colour (Horizontal rail):	Black (Silver optional)
Colour (Poles & ceiling mount):	Black
Warranty:	5 years
Accessories:	Cover plates

MBC4X4U2



- 
 Back to back optional
- 
 Cable management
- 
 Landscape and portrait
- 
 Max load tested 5x
- 
 Micro adjustable

Model:	MBC4X4U2
Recommended screen size:	46" - 65"
VESA & Non-VESA Fixings:	VESA 400, 40cm
EAN:	735007373 3613
Max load:	30kg (Per screen)
Bracket type:	Micro-Adjustable Arms
Landscape / portrait:	Yes
Pole length:	80 cm up to 300 cm
Colour (VESA arms):	Black
Colour (Horizontal rail):	Black (Silver optional)
Colour (Poles & ceiling mount):	Black
Warranty:	5 years
Accessories:	Cover plates

Face down Ceilingmounts



**M Pro Series
VESA Face Down Mount 200/300/400**

EAN: 735010521 5902

For screen size: 32" - 75"

Universal & VESA standard: Adjustable from 100x100 to 400x400 max

Material: Steel, Aluminium, Plastic

Color: Black

Weight: 4.5 kg

Measurements: 48 x 27 x 6.5 cm

Max Load: 50kg/screen (TUV level is 30kg/screen)

Tilt: 0° ~ 10°

Options: M Pro Series Parts

Certifications: CE

Warranty: 5 years



Mount a display to a ceiling with the display facing down.

Unique digital signage solution capable of mounting a single screen up to 35kg, to a ceiling with the display facing down.

The new professional Pro Series A/V line from Multibrackets was designed with the installer in mind.

Working closely with installers we created a range with close to unlimited flexibility.

The product provides the versatility and flexibility demanded by installers.

Based upon the Pro Series strong and ultra-flexible aluminum rail it is completely modular and has built in cable management throughout the entire solution to quicken installation and creating an esthetic result worth the public eye.

**M Ceiling Mount Pro Face Down
VESA 200/300/400**

EAN: 735010521 5919

For screen size: 32" - 65"

Universal & VESA standard: Adjustable from 100x100 to 400x400 max

Material: Steel, Aluminium

Color: Black

Weight: 12 kg

Measurements: 84.5 x 26.5 x 10.5 cm

Max Load: 50 kg

Pillar length: Min: 580mm to Max: 1550 mm

From ceiling to VESA plate center: Black (Silver optional)

Tilt: Yes, -15°~+15°

Certifications: CE

Warranty: 5 years

Ceiling mounted Triple and quad solutions

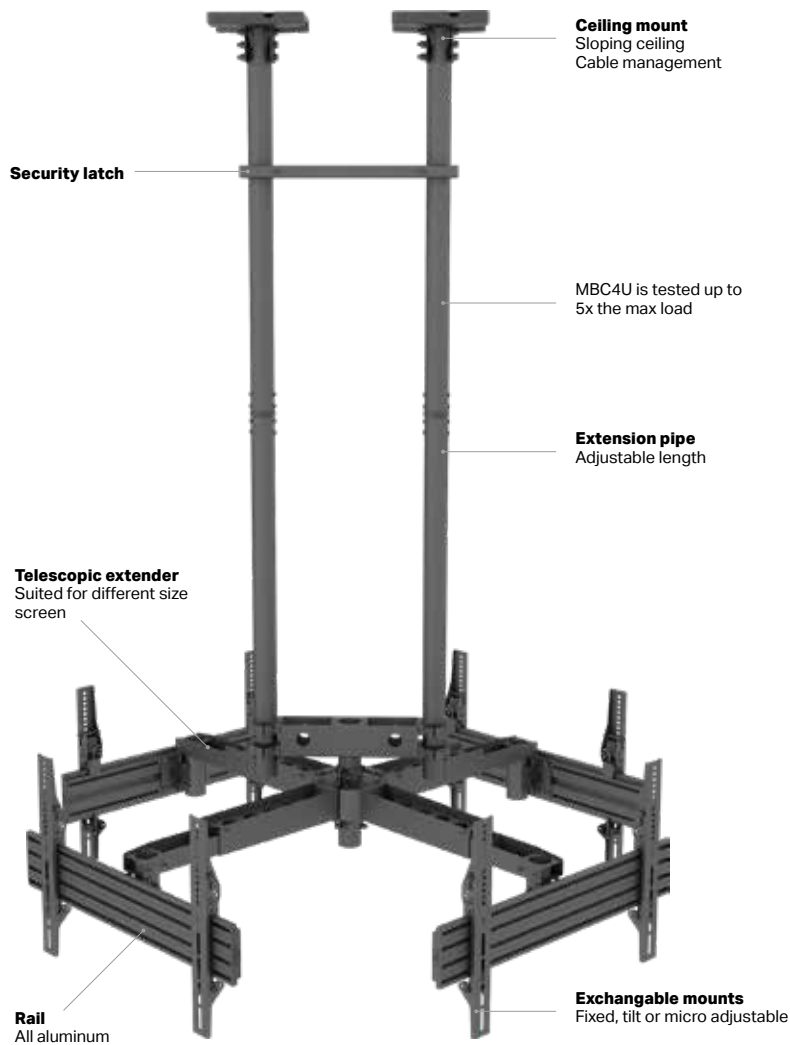

Pro Series tested for 5 times the max load



Selected models are TUV approved



Design plate cover ceiling installation

MBC3U



MBC4U



MBC3UHD



MBC2P4U



	MBC3U	MBC4U	MBC3UHD	MBC2P4U
Model:	MBC3U	MBC4U	MBC3UHD	MBC2P4U
Recommended screen size:	32" - 65"	32" - 65"	50" - 75"	50" - 75"
VESA & Non-VESA Fixings:	VESA 400, 40cm	VESA 400, 40cm	VESA 400, 40cm	VESA 400, 40cm
EAN:	735007373 3521	735007373 3538	735007373 8861	735007373 8878
Max load:	30kg (Per screen)	30kg (Per screen)	30kg (Per screen)	30kg (Per screen)
Bracket type:	Tilt	Tilt	Tilt	Tilt
Landscape / portrait:	Yes	Yes	Yes	Yes
Pole length:	80 cm up to 300 cm	80 cm up to 300 cm	80 cm up to 300 cm	80 cm up to 300 cm
Colour (VESA arms):	Black	Black	Black	Black
Colour (Horizontal rail):	Black (Silver optional)	Black (Silver optional)	Black (Silver optional)	Black (Silver optional)
Colour (Poles & ceiling mount):	Black	Black	Black	Black
Warranty:	5 years	5 years	5 years	5 years
Accessories:	Cover plates	Cover plates	Cover plates	Cover plates

LG 110UM5J Tilt Black



MBC8U



MBC1U White



MBC1USD 600 White



	Model: LG 110UM5J Tilt Black	MBC8U	MBC2UPV 50/100/200	MBC2UPV 400
Recommended screen size:	75" - 110"	32" - 65"	32" - 43"	46" - 65"
VESA & Non-VESA Fixings:	VESA 1500x600mm	VESA 600x400mm	VESA 200, 20cm	VESA 400, 40cm
EAN:	735010521 4561	735010521 6251	735010521 2451	735010521 2468
Max load:	80kg	30kg (Per screen)	30kg (Per screen)	30kg (Per screen)
Bracket type:	Tilt (Fixed optional)	Tilt (Fixed optional)	Tilt (Fixed optional)	Tilt (Fixed optional)
Landscape / portrait:	Yes	Yes	Yes	Yes
Pole length:	80 cm up to 150 cm	80 cm up to 300 cm	80 cm up to 300 cm	80 cm up to 300 cm
Colour (VESA arms):	Black	Black	Black	Black
Colour (Horizontal rail):	Black (Silver optional)	Black (Silver optional)	Black (Silver optional)	Black (Silver optional)
Colour (Poles & ceiling mount):	Black	Black	Black	Black
Warranty:	5 years	5 years	5 years	5 years
Accessories:	Cover plates	Cover plates	Cover plates	Cover plates

Large Screen Ceiling Mounts

The Dual Pole range of Pro Series Ceilingmounts designed to support one or two large size screens mounted back-to-back in either landscape or portrait. Simple to install, clean and attractive design, yet very robust and functional the Dual Pole series is ideal for a wide variety of applications and setting.

Designed to provide the ideal display viewing placement and match the décor of any environment. Ideal for public areas like stores, training rooms, lobbies, classrooms, auditoriums, or exhibit halls. As with all Pro series products a full line-up of accessories offering tailor possibilities functionality to meet your specific requirements. Internal cable management hides the AV cabling, showing a clean look.

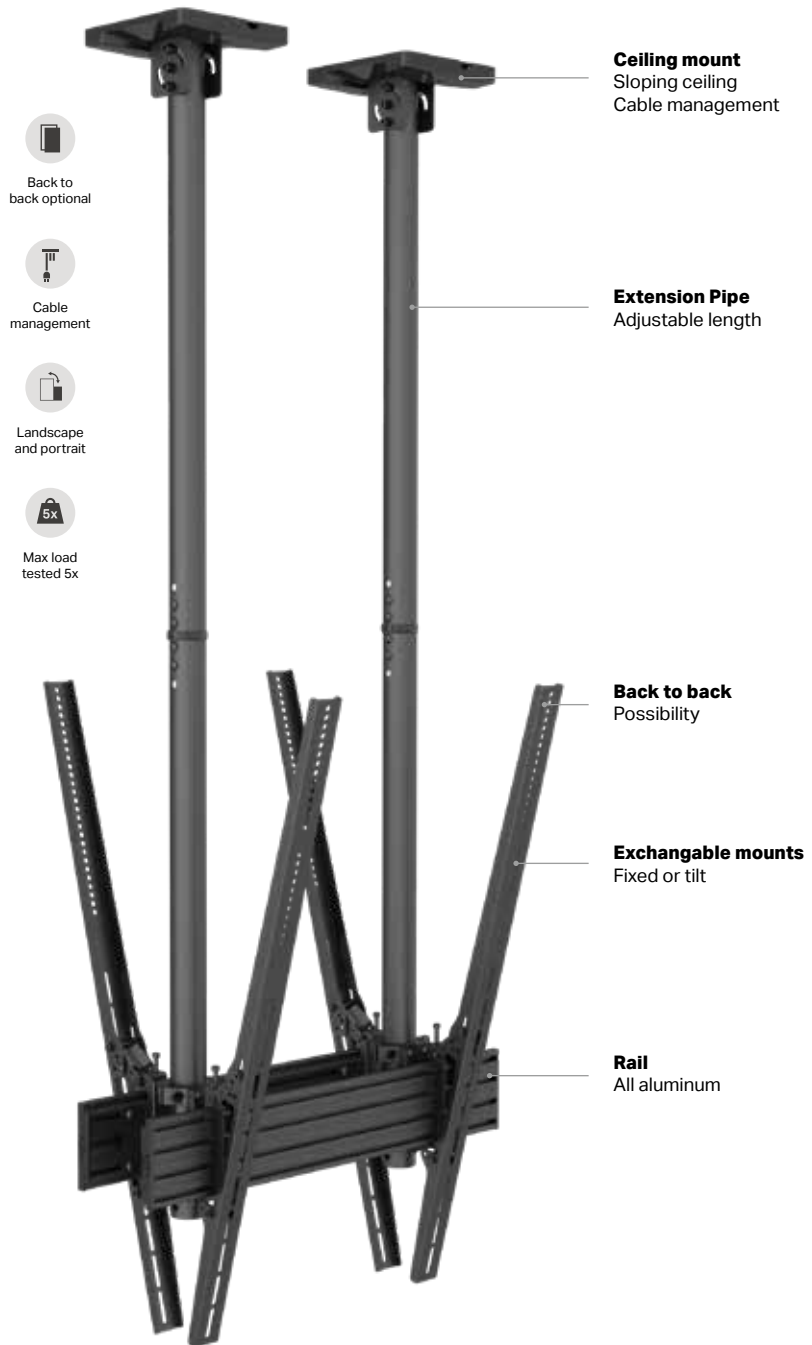

MBC1USD 600



MBC1UX2SD 600



MBC4X1U VESA 200



MBC1USD 900 White



	MBC1USD 600	MBC1UPHD2	MBC1UX2SD 600	MBC1USD 900 White
Recommended screen size:	40" - 100"	40" - 100"	40" - 75"	40" - 100"
VESA & Non-VESA Fixings:	VESA 600x400mm	VESA 400x600mm	VESA 600x400mm	VESA 900x600mm
EAN:	735010521 2321	735010521 6404	735010521 4677	735010521 7371
Max load:	120kg	75kg (Per screen)	30kg (Per screen)	120kg
Bracket type:	Tilt (Fixed optional)	Tilt (Fixed optional)	Tilt (Fixed optional)	Tilt (Fixed optional)
Landscape / portrait:	Yes	Yes	Yes	Yes
Pole length:	80 cm up to 150 cm	80 cm up to 150 cm	80 cm up to 150 cm	80 cm up to 150 cm
Colour (VESA arms):	Black	Black	Black	Black
Colour (Horizontal rail):	Black (Silver optional)	Black (Silver optional)	Black (Silver optional)	Black (Silver optional)
Colour (Poles & ceiling mount):	Black	Black	Black	White
Warranty:	5 years	5 years	5 years	5 years
Accessories:	Cover plates	Cover plates	Cover plates	Cover plates

MBC1UHD



MBC1USD



MBC1UX2HD



MBC1UX2SD



	MBC1UHD	MBC1USD	MBC1UX2HD	MBC1UX2SD
Model:	MBC1UHD	MBC1USD	MBC1UX2HD	MBC1UX2SD
Recommended screen size:	40" - 75"	40" - 100"	40" - 75 "	40" - 100"
VESA & Non-VESA Fixings:	VESA 600, 60cm	VESA 600, 60cm	VESA 600, 60cm	VESA 600, 60cm
EAN:	735007373 5778	735007373 5785	735007373 6232	735007373 6249
Max load:	90kg	135kg (Per screen)	90kg (Per screen)	90kg (Per screen)
Bracket type:	Tilt (Fixed optional)	Tilt (Fixed optional)	Tilt (Fixed optional)	Tilt (Fixed optional)
Landscape / portrait:	Yes	Yes	Yes	Yes
Pole length:	58 cm up to 150 cm	58 cm up to 150 cm	58 cm up to 150 cm	58 cm up to 150 cm
Colour (VESA arms):	Black	Black	Black	Black
Colour (Horizontal rail):	Black (Silver optional)	Black (Silver optional)	Black (Silver optional)	Black (Silver optional)
Colour (Poles & ceiling mount):	Black	Black	Black	Black
Warranty:	5 years	5 years	5 years	5 years
Accessories:	Cover plates	Cover plates	--	--

MBC1UPHD



MBC1UPSD



MBC1UX2PHD



MBC1UX2PSD



	MBC1UPHD	MBC1UPSD	MBC1UX2PHD	MBC1UX2PSD
Model:	MBC1UPHD	MBC1UPSD	MBC1UX2PHD	MBC1UX2PSD
Recommended screen size:	40" - 75"	40" - 100"	40" - 75"	40" - 100"
VESA & Non-VESA Fixings:	VESA 900, 90cm	VESA 900, 90cm	VESA 900, 90cm	VESA 900, 90cm
EAN:	735007373 6126	735007373 6133	735007373 6256	735007373 6263
Max load:	90kg	180kg	90kg (Per screen)	90kg (Per screen)
Bracket type:	Tilt (Fixed optional)	Tilt (Fixed optional)	Tilt (Fixed optional)	Tilt (Fixed optional)
Landscape / portrait:	Yes	Yes	Yes	Yes
Pole length:	58 cm up to 150 cm	58 cm up to 150 cm	58 cm up to 150 cm	58 cm up to 150 cm
Colour (VESA arms):	Black	Black	Black	Black
Colour (Horizontal rail):	Black (Silver optional)	Black (Silver optional)	Black (Silver optional)	Black (Silver optional)
Colour (Poles & ceiling mount):	Black	Black	Black	Black
Warranty:	5 years	5 years	5 years	5 years
Accessories:	Cover plates	Cover plates	--	--

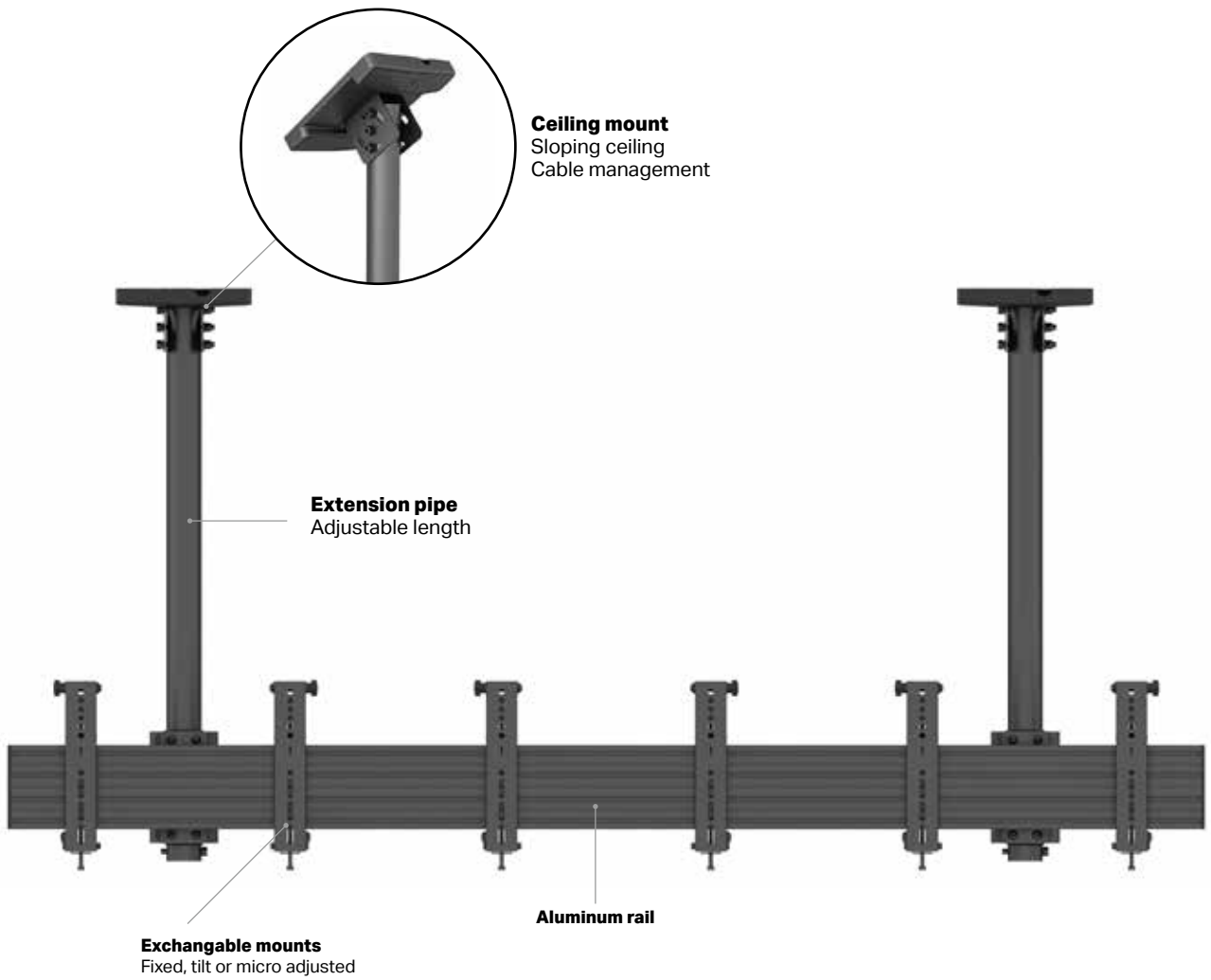

Back to back optional



Cable management



Landscape and portrait



Max load tested 5x



Micro adjustable



Multiple color options

Pro Series Menu Boards Mounts ceilingmounted

- . Universal design suitable for all sized screens up to 100"
- . High-end aesthetics
- . Designed to handle landscape or portrait mounting
- . Brackets fixed, tilt or micro adjustable
- . Support a wide range of VESA 75/100/200/300/400/600/900
- . Built in levelling screws to adjust the screen height
- . Built in cable management
- . Add or change displays after time, Pro Series follows
- . Selected models are TUV certified



Flexible menu boards. Starting at 1U builds up to 10U's side by side, landscape or portrait.

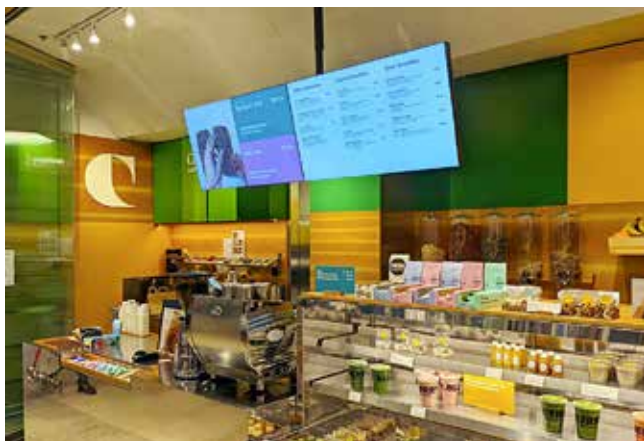

MB2X1U with Dual Displays Landscape



Can be mounted on wall

Our Menuboard

Our Menuboard are great for installers and digital signage installations. Either ceiling mounted or wall mounted.

The ceiling mounted solutions make it possible to construct single, dual or video walls in prominent locations where walls aren't available. Comes in a variety of arrangements.

Our menuboard are designed to deliver a simple solution for any digital signage installation involving multiple commercial displays 32"-100".

Perfect for many commercial installations the space saving design ensures the very best installer experience. Mount screens in landscape or portrait

orientation with the option for tilt adjustment for enhanced overhead visibility, perfect for public places, food restaurants or a reception.

As part of the Pro Series, these menuboard can be combined with other Pro Series products and used in any possible configurations meeting your re-

quirements. High end aesthetic and flexibility to use fixed, tilted or micro adjustable brackets makes fitting screen to screen a dream.

All arms feature levelling screws to adjust the screen height.

MBC1X1U VESA 200



MBC2X1U VESA 200



MBC3X1U VESA 200



MBC4X1U VESA 200



MBC5X1UP VESA 200



MBC6X1U VESA 200



	MBC1X1U VESA 200	MBC2X1U VESA 200	MBC3X1U VESA 200	MBC4X1U VESA 200	MBC5X1UP VESA 200	MBC6X1U VESA 200
Model:	MBC1X1U VESA 200	MBC2X1U VESA 200	MBC3X1U VESA 200	MBC4X1U VESA 200	MBC5X1UP VESA 200	MBC6X1U VESA 200
Recommended screen size:	24" - 43"	30" - 42"	27" - 32"	27" - 32"	27" - 32"	27" - 32"
VESA & Non-VESA Fixings:	VESA 200, 20cm	VESA 200, 20cm	VESA 200, 20cm	VESA 200, 20cm	VESA 200, 20cm	VESA 200, 20cm
EAN:	735010521 2321	735010521 2253	735007373 5662	735007373 5679	735010521 5063	735010521 6398
Max load:	30kg	30kg	30kg (Per screen)	30kg (Per screen)	30kg (Per screen)	30kg (Per screen)
Bracket type:	Tilt (Fixed optional)	Tilt (Fixed optional)	Tilt (Fixed optional)	Tilt (Fixed optional)	Tilt (Fixed optional)	Tilt (Fixed optional)
Landscape / portrait:	Yes		Yes	Yes	Portrait	
Pole length:	80 cm up to 150 cm		80 cm up to 150 cm	80 cm up to 150 cm		
Colour (VESA arms):	Black	Black	Black	Black	Black	Black
Colour (Horizontal rail):	Black (Silver optional)	Black (Silver optional)	Black (Silver optional)	Black (Silver optional)	Black (Silver optional)	Black (Silver optional)
Colour (Poles & ceiling mount):	Black	Black	Black	Black	Black	Black
Warranty:	5 years	5 years	5 years	5 years	5 years	5 years
Accessories:	Cover plates	Cover plates	Cover plates	Cover plates	Cover plates	Cover plates

MBC1U, VESA 300



MBC2X1U, VESA 300



MBC3X1U, VESA 300



MBC4X1UP



MBC4X1U VESA 300



MBC5X1UP VESA 300



Model:	MBC1U, VESA 300	MBC2X1U, VESA 300	MBC3X1U, VESA 300	MBC4X1UP	MBC4X1U VESA 300	MBC5X1UP VESA 300
Recommended screen size:	32" - 50"	32" - 50"	32" - 50"	32" - 65"	32" - 50"	32" - 50"
VESA & Non-VESA Fixings:	VESA 300, 30cm	VESA 300, 30cm	VESA 300, 30cm	VESA 400, 40cm	VESA 300, 30cm	VESA 300, 30cm
EAN:	735002273 7891	735002273 7907	735002273 7914	735007373 4931	735010521 6473	735002273 7938
Max load:	30kg (Per screen)	30kg (Per screen)	30kg (Per screen)	30kg (Per screen)	30kg (Per screen)	30kg (Per screen)
Bracket type:	Tilt (Fixed optional)	Tilt (Fixed optional)	Tilt (Fixed optional)	Tilt (Fixed optional)	Tilt (Fixed optional)	Tilt (Fixed optional)
Landscape / portrait:	Landscape	Landscape	Landscape	Portrait	Landscape	Portrait
Pole length:	80 cm up to 150 cm	80 cm up to 150 cm	80 cm up to 150 cm	80 cm up to 150 cm	80 cm up to 150 cm	80 cm up to 150 cm
Colour (VESA arms):	Black	Black	Black	Black	Black	Black
Colour (Horizontal rail):	Black (Silver optional)	Black (Silver optional)	Black (Silver optional)	Black (Silver optional)	Black (Silver optional)	Black (Silver optional)
Colour (Poles & ceiling mount):	Black	Black	Black	Black	Black	Black
Warranty:	5 years	5 years	5 years	5 years	5 years	5 years
Accessories:	Cover plates	Cover plates	Cover plates	Cover plates	Cover plates	Cover plates

MBC1X1U VESA 400

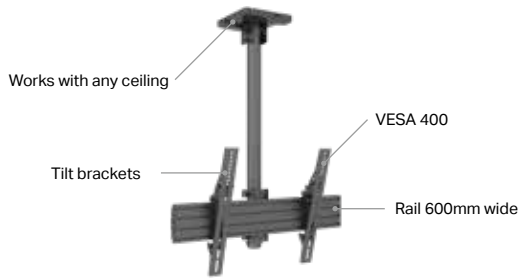

MBC2X1U VESA 400



MBC3X1U VESA 400



MBC4X1U VESA 400



MBC5X1U VESA 400

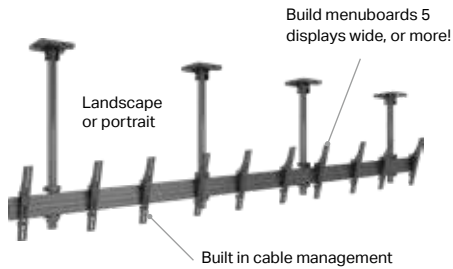

MBC5X1UP VESA 400

7350105215070 M Menu Board Mount Pro MBC5X1UP



Model:	MBC1X1U	MBC2X1U	MBC3X1U	MBC4X1U	MBC5X1U	MBC5X1UP
Recommended screen size:	32" - 65"	32" - 65"	32" - 65"	32" - 65"	40" - 65"	32" - 55"
VESA & Non-VESA Fixings:	VESA 400, 40cm	VESA 400, 40cm	VESA 400, 40cm	VESA 400, 40cm	VESA 400, 40cm	VESA 400, 40cm
EAN:	735010521 2338	735007373 3460	735007373 4924	735007373 3484	735010521 5360	735010521 5070
Max load:	30kg (Per screen)	30kg (Per screen)	30kg (Per screen)	30kg (Per screen)	30kg (Per screen)	30kg (Per screen)
Bracket type:	Tilt (Fixed optional)	Tilt (Fixed optional)	Tilt (Fixed optional)	Tilt (Fixed optional)	Tilt (Fixed optional)	Tilt (Fixed optional)
Landscape / portrait:	Yes	Landscape	Portrait	Landscape	Landscape	Portrait
Pole length:	58 cm up to 150 cm	80 cm up to 150 cm	80 cm up to 150 cm	80 cm up to 150 cm	80 cm up to 150 cm	
Colour (VESA arms):	Black	Black	Black	Black	Black	Black
Colour (Horizontal rail):	Black (Silver optional)	Black (Silver optional)	Black (Silver optional)	Black (Silver optional)	Black (Silver optional)	Black (Silver optional)
Colour (Poles & ceiling mount):	Black	Black	Black	Black	Black	Black
Warranty:	5 years	5 years	5 years	5 years	5 years	5 years
Accessories:	Cover plates	Cover plates	Cover plates	Cover plates	Cover plates	Cover plates



Menu boards that holds perfect position and quality over time, Great for installers!

Pro Series Menu Board Mounts **Wallmounted**

Multibrackets line up of Wall mounted Menu Board Mounts are designed to create a seamless mounting surface through connecting displays side by side on the M Pro Series rail system. The single horizontal aluminum rail extrusion with depth

adjustment aligns the screens quickly even on irregular mounting surfaces and allows easy access behind the displays for servicing. Fixed/tilt/ fine tune bracket options from VESA 50 to VESA 900 allows close to all displays to be tilted at the same angle

with ease, creating a flawless alignment. These Menu Board Mounts allow for tool-less height and depth adjustment to alleviate issues with wall imperfections. Delivered with built in cable management, reducing installation time and cost. Available in landscape

and portrait design options, standard landscape or portrait designs for 27" to 65" displays or customs sized for larger size displays.

MBW1U Tilt 200



MBW2U Tilt 200



MBW3U Tilt 200



MBW4X1U Tilt VESA 300



	MBW1U Tilt 200	MBW2U Tilt 200	MBW3U Tilt 200	MBW4X1U Tilt VESA 300
Model:	MBW1U Tilt 200	MBW2U Tilt 200	MBW3U Tilt 200	MBW4X1U Tilt VESA 300
Recommended screen size:	24" - 43"	24" - 43"	24" - 43"	32" - 50"
VESA & Non-VESA Fixings:	VESA 200, 20cm	VESA 200, 20cm	VESA 200, 20cm	VESA 300, 30cm
EAN:	735007373 7024	735007373 7031	735007373 7048	735010521 6046
Max load:	30kg	30kg	30kg	50kg (Per screen)
Bracket type:	Tilt (Fixed optional)	Tilt (Fixed optional)	Tilt (Fixed optional)	Tilt (Fixed optional)
Landscape / portrait:	Yes	Yes	Yes	Yes
Pole length:	80 cm up to 150 cm	80 cm up to 150 cm	80 cm up to 150 cm	80 cm up to 150 cm
Colour (VESA arms):	Black	Black	Black	Black
Colour (Horizontal rail):	Black	Black	Black	Black
Colour (Poles & ceiling mount):	Black	Black	Black	Black
Warranty:	5 years	5 years	5 years	5 years
Accessories:	Cover plates	Cover plates	Cover plates	Cover plates

MBW2X1U 400



MBC3X1U 400

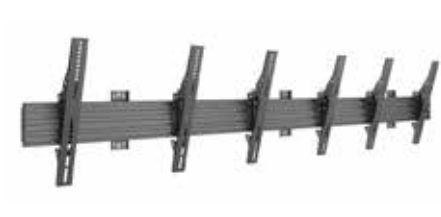

MBC3X1UP 400



MBC4X1UP 400

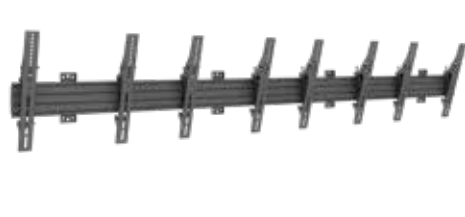

	MBW2X1U 400	MBC3X1U 400	MBC3X1UP 400	MBC4X1UP 400
Model:	MBW2X1U 400	MBC3X1U 400	MBC3X1UP 400	MBC4X1UP 400
Recommended screen size:	32" - 65"	32" - 65"	32" - 65"	32" - 65"
VESA & Non-VESA Fixings:	VESA 400, 40cm	VESA 400, 40cm	VESA 400, 40cm	VESA 400, 40cm
EAN:	735007373 4061	735007373 4078	735007373 4061 +735007373 3743	735007373 4078 +735007373 3743
Max load:	30kg (Per screen)	30kg (Per screen)	30kg (Per screen)	30kg (Per screen)
Bracket type:	Tilt (Fixed optional)	Tilt (Fixed optional)	Tilt (Fixed optional)	Tilt (Fixed optional)
Landscape / portrait:	Yes	Yes	Yes	Yes
Pole length:	80 cm up to 150 cm	80 cm up to 150 cm	80 cm up to 150 cm	80 cm up to 150 cm
Colour (VESA arms):	Black	Black	Black	Black
Colour (Horizontal rail):	Black	Black	Black	Black
Colour (Poles & ceiling mount):	Black	Black	Black	Black
Warranty:	5 years	5 years	5 years	5 years
Accessories:	Cover plates	Cover plates	Cover plates	Cover plates



Design cone cover floor and ceiling mount



Selected models are TUV approved



Pro Series tested for 5 times the max load

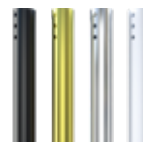

Change color of the poles

Pro Series Floor to Ceiling Mounts Solutions

Our floor to ceiling solutions makes it possible to construct menu boards in prominent locations where walls aren't available. An aesthetic solution that adds stability to locations

where the ceiling or wall aren't able to support an installation. In store Digital Signage is one of the fastest growing sector of the POS market. Our unique floor to ceiling mounts

solutions are both dynamic and flexible and often becomes an immediate focal point with holding a display with modern looks and eye catching clean appearance.

New model:
MBFC1UD: 735007373 7734
(As shown on picture)

MBFC1U



MBFC1U Brass



MBFC1U Chrome



MBFC1U White



	MBFC1U	MBFC1U Brass	MBFC1U Chrome	MBFC1U White
Model:	MBFC1U	MBFC1U Brass	MBFC1U Chrome	MBFC1U White
Recommended screen size:	32" - 65"	32" - 65"	32" - 65"	32" - 65"
VESA & Non-VESA Fixings:	VESA 400, 40cm	VESA 400, 40cm	VESA 400, 40cm	VESA 400, 40cm
EAN:	735007373 3620	735007373 5709	735007373 5693	735007373 5686
Max load:	30kg (Per screen)	30kg (Per screen)	30kg (Per screen)	30kg (Per screen)
Bracket type:	Fixed	Fixed	Fixed	Fixed
Landscape / portrait:	Yes	Yes	Yes	Yes
Pole length:	150 cm up to 300 cm	150 cm up to 300 cm	150 cm up to 300 cm	150 cm up to 300 cm
Colour (VESA arms):	Black	Black	Black	Black
Colour (Horizontal rail):	Black (Silver optional)	Black (Silver optional)	Black (Silver optional)	Black (Silver optional)
Colour (Poles & ceiling mount):	Black	Black	Black	Black
Warranty:	5 years	5 years	5 years	5 years
Accessories:	Cover plates	Cover plates	Cover plates	Cover plates



Pro Series

Hospitality products

With the rapid change in A/V solutions its important to utilize hardware and services to enable its full value. Hotels, Restaurants, Bars or Sports arenas. Always keep your guests happy.

- Hotel rooms
- Bar/ Restaurant
- Conference room
- Guest Room
- Gym/ Spa
- Lobby
- Reception/ Desk
- Health Care Room

MBFC1UD

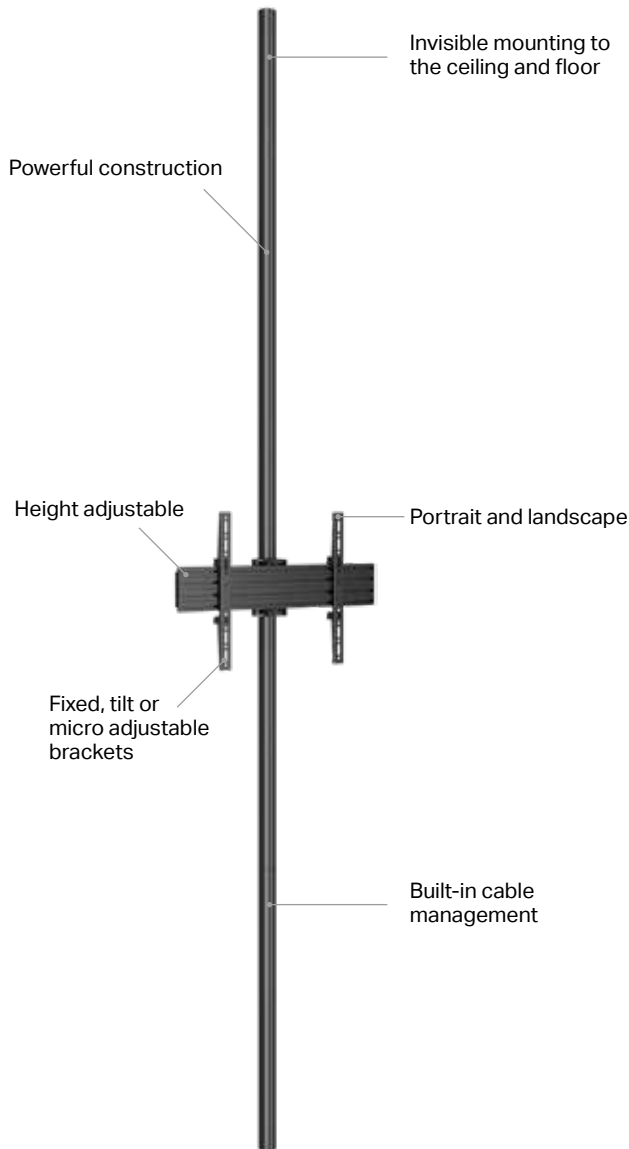

Highlights:

- A professional, flexible and modular product
- Includes VESA adapters for compatibility up to VESA 600x400
- Integrated cable management throughout the entire solution
- Power click install for an easy, fast and safe installation
- Portrait or landscape position of screen possible
- Hardware kit included

Model:	MBFC1UD
EAN:	7350073737734
For screen size:	40"-65"
Type:	Single Side MBFC1U
Universal & VESA standard:	100x100,200x200,300x300,400x400
Material:	Steel, Aluminium
Color:	Black
Surface Finish:	Powder coating
Weight:	13 kg
Measurements	49x17.4x300 cm
Max Load:	30 kg per screen
Pillar length:	3000 mm from ceiling to VESA plate center
Cable Management:	Yes
Options:	Extension pipes : 0.8m, 1.5m, 3.0m
Certifications:	CE
Warranty:	5 years

MBFC2U

Flexible design.
Two screens
back to back or
two displays on top
of each other.

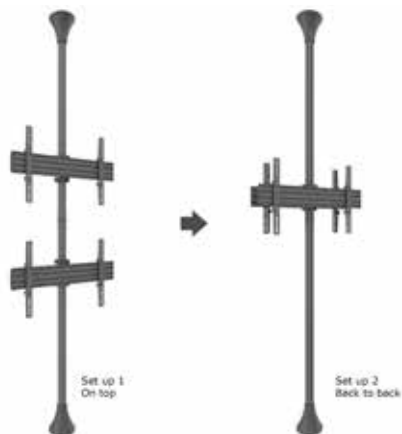

MBFC2U Brass

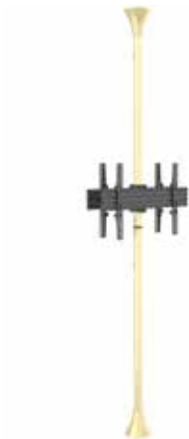

MBFC2U Chrome



MBFC2U White



	MBFC1U	MBFC3U Brass	MBFC1U Chrome	MBFC1U White
Model:	MBFC1U	MBFC3U Brass	MBFC1U Chrome	MBFC1U White
Recommended screen size:	32" - 65"	32" - 65"	32" - 65"	32" - 65"
VESA & Non-VESA Fixings:	VESA 400, 40cm	VESA 400, 40cm	VESA 400, 40cm	VESA 400, 40cm
EAN:	735007373 3637	735007373 5730	735007373 5723	735007373 5716
Max load:	30kg (Per screen)	30kg (Per screen)	30kg (Per screen)	30kg (Per screen)
Bracket type:	Fixed	Fixed	Fixed	Fixed
Landscape / portrait:	Yes	Yes	Yes	Yes
Pole length:	150 cm up to 300 cm	150 cm up to 300 cm	150 cm up to 300 cm	150 cm up to 300 cm
Colour (VESA arms):	Black	Black	Black	Black
Colour (Horizontal rail):	Black (Silver optional)	Black (Silver optional)	Black (Silver optional)	Black (Silver optional)
Colour (Poles & ceiling mount):	Black	Black	Black	Black
Warranty:	5 years	5 years	5 years	5 years
Accessories:	Cover plates	Cover plates	Cover plates	Cover plates

MBFC3U



MBFC3U Brass



MBFC3U Chrome



MBFC3U White



	MBFC3U	MBFC3U Brass	MBFC3U Chrome	MBFC3U White
Model:	MBFC3U	MBFC3U Brass	MBFC3U Chrome	MBFC3U White
Recommended screen size:	32" - 65"	32" - 65"	32" - 65"	32" - 65"
VESA & Non-VESA Fixings:	VESA 400, 40cm	VESA 400, 40cm	VESA 400, 40cm	VESA 400, 40cm
EAN:	735007373 3644	735007373 5761	735007373 5754	735007373 5747
Max load:	30kg (Per screen)	30kg (Per screen)	30kg (Per screen)	30kg (Per screen)
Bracket type:	Fixed	Fixed	Fixed	Fixed
Landscape / portrait:	Yes	Yes	Yes	Yes
Pole length:	150 cm up to 300 cm	150 cm up to 300 cm	150 cm up to 300 cm	150 cm up to 300 cm
Colour (VESA arms):	Black	Black	Black	Black
Colour (Horizontal rail):	Black (Silver optional)	Black (Silver optional)	Black (Silver optional)	Black (Silver optional)
Colour (Poles & ceiling mount):	Black	Black	Black	Black
Warranty:	5 years	5 years	5 years	5 years
Accessories:	Cover plates	Cover plates	Cover plates	Cover plates

MBFC1X2U2

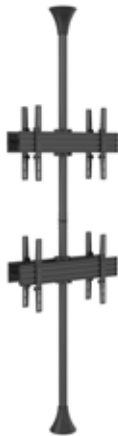

For back to back add items per piece :

- 7350073733668 Pole Clamp
- 7350073733866 Single Rail
- 7350073733736 Fixed arms(40cm)

MBFC1X3U2



For back to back add items per piece :

- 7350073733668 Pole Clamp
- 7350073733866 Single Rail
- 7350073733736 Fixed arms(40cm)



Peak Performance flagship store Copenhagen

	MBFC1X2U2	MBFC1X3U2
Model:	MBFC1X2U2	MBFC1X3U2
Recommended screen size:	32" - 65"	32" - 65"
VESA & Non-VESA Fixings:	VESA 400, 40cm	VESA 400, 40cm
EAN:	735007373 4962	735007373 4979
Max load:	30kg (Per screen)	30kg (Per screen)
Bracket type:	Fixed	Fixed
Landscape / portrait:	Yes	Yes
Pole length:	150 cm up to 300 cm	150 cm up to 300 cm
Colour (VESA arms):	Black	Black
Colour (Horizontal rail):	Black (Silver optional)	Black (Silver optional)
Colour (Poles & ceiling mount):	Black/ Brass/ Chrome/ White	Black/ Brass/ Chrome/ White
Warranty:	5 years	5 years
Accessories:	Cover plates	Cover plates

MBFC2X3U

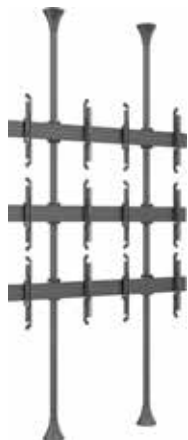

MBFC3X3U

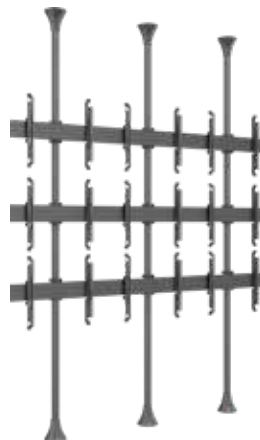

MBFC2UX2

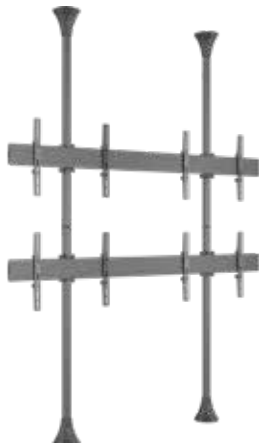

MBFC2UX3



	MBFC2X3U	MBFC3X3U	MBFC2UX2	MBFC2UX3
Model:	MBFC2X3U	MBFC3X3U	MBFC2UX2	MBFC2UX3
Recommended screen size:	32" - 65"	32" - 65"	40" - 65"	40" - 65"
VESA & Non-VESA Fixings:	VESA 400, 40cm	VESA 400, 40cm	VESA400, 40cm	VESA400, 40cm
EAN:	735007373 4986	735007373 4933	735010521 6084	735010521 6091
Max load:	30kg (Per screen)	30kg (Per screen)	30kg (Per screen)	30kg (Per screen)
Bracket type:	Micro-Adjustable Arms	Micro-Adjustable Arms	Fixed (Tilt optional)	Fixed (Tilt optional)
Landscape / portrait:	Yes	Yes	Yes	Yes
Pole length:	150 cm up to 300 cm	150 cm up to 300 cm	80 cm up to 300 cm	80 cm up to 300 cm
Colour (VESA arms):	Black	Black	Black	Black
Colour (Horizontal rail):	Black (Silver optional)	Black (Silver optional)	Black (Silver optional)	Black (Silver optional)
Colour (Poles & ceiling mount):	Black/ Brass/ Chrome/ White	Black/ Brass/ Chrome/ White	Black	Black
Warranty:	5 years	5 years	5 years	5 years
Accessories:	Cover plates	Cover plates	Cover plates	Cover plates

MBFC3UX2

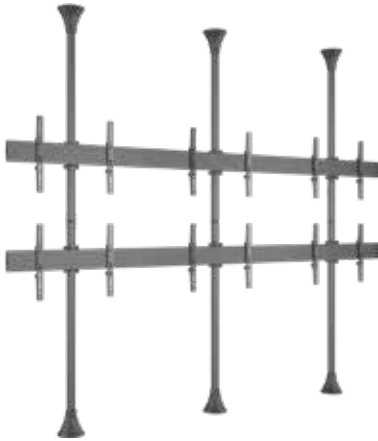

MBFC3UX3

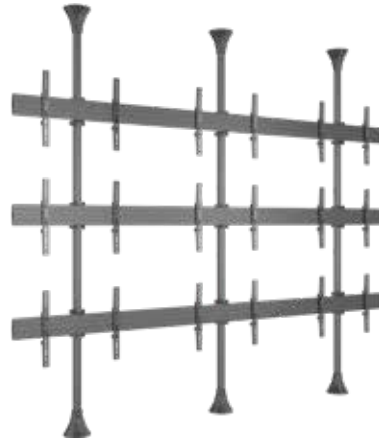

MBFC3UX3 Micro Adjustable



MBFC7UX3 Micro Adjustable

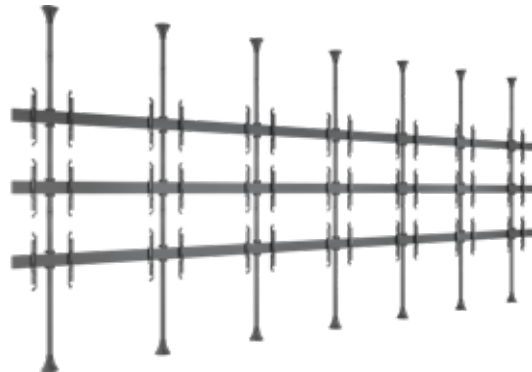

	Model: MBFC3UX2	MBFC3UX3	MBFC3UX3 Micro Adjustable	MBFC7UX3 MicroAdjustable
Recommended screen size:	40" - 65"	40" - 65"	40" - 65"	40" - 65"
VESA & Non-VESA Fixings:	VESA400, 40cm	VESA400, 40cm	VESA400, 40cm	VESA400, 40cm
EAN:	7350105216107	7350105216114	7350105216657	7350105216664
Max load:	30kg (Per screen)	30kg (Per screen)	30kg (Per screen)	30kg (Per screen)
Bracket type:	Fixed (Tilt optional)	Fixed (Tilt optional)	Micro-Adjustable Arms	Micro-Adjustable Arms
Landscape / portrait:	Yes	Yes	Yes	Portrait
Pole length:	150 cm up to 300 cm	150 cm up to 300 cm	150 cm up to 390 cm	150 cm up to 390 cm
Colour (VESA arms):	Black	Black	Black	Black
Colour (Horizontal rail):	Black (Silver optional)	Black (Silver optional)	Black (Silver optional)	Black (Silver optional)
Colour (Poles & ceiling mount):	Black	Black	Black	Black
Warranty:	5 years	5 years	5 years	5 years
Accessories:	Cover plates	Cover plates	Cover plates	Cover plates

MBFC1UX1 800



MBFC1UX1 1000



MBFC1UX1 1600

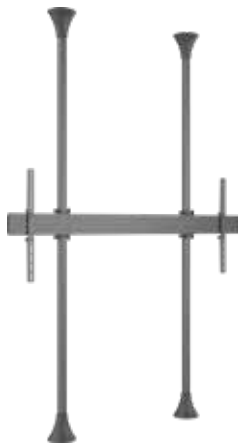

	Model: MBFC1UX1 800	MBFC1UX1 1000	MBFC1UX1 1600
Recommended screen size:	65" - 100"	65" - 100"	40" - 65"
VESA & Non-VESA Fixings:	800x600mm	1000x600mm	1600x600mm
EAN:	7350105217401	7350105217395	7350105217388
Max load:	125kg	125kg	125kg
Bracket type:	Fixed (Tilt optional)	Fixed (Tilt optional)	Fixed (Tilt optional)
Landscape / portrait:	Yes	Yes	Yes
Pole length:	80 cm up to 300 cm	80 cm up to 300 cm	80 cm up to 300 cm
Colour (VESA arms):	Black	Black	Black
Colour (Horizontal rail):	Black (Silver optional)	Black (Silver optional)	Black (Silver optional)
Colour (Poles & ceiling mount):	Black	Black	Black
Warranty:	5 years	5 years	5 years
Accessories:	Cover plates	Cover plates	Cover plates

Pro Series Floor to Ceiling Mounts Pro

In store Digital Signage is one of the fastest growing sector of the POS market. Our unique floor to ceiling mounts solutions are both dynamic and flexible and often becomes an immediate focal point with holding a display with modern looks and eye catching clean appearance.

New model:

MBFC1UD: 735007373 7932

(As shown on picture)

Add extra brackets:

Pole bracket 800x600



EAN: 7350105210310

Pole bracket 600x900



EAN: 7350105210310

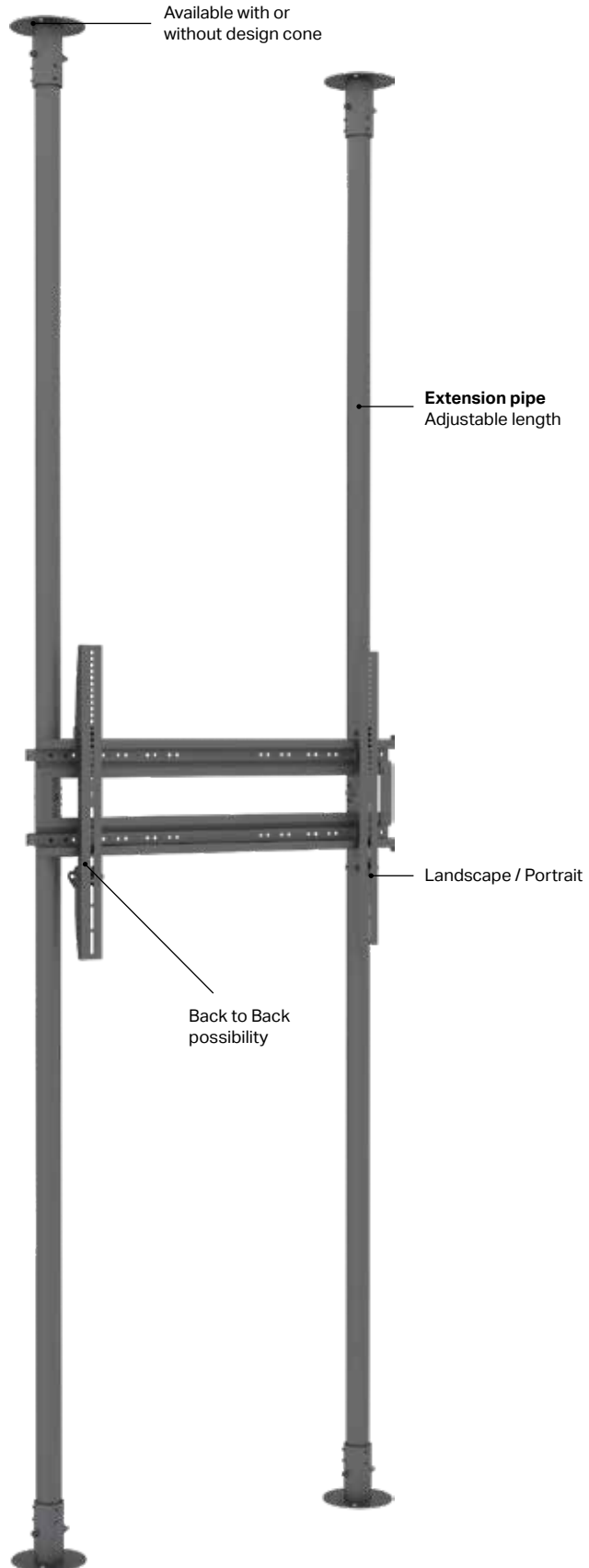

MBFC1UHD



Single landscape

MBFC2UHD

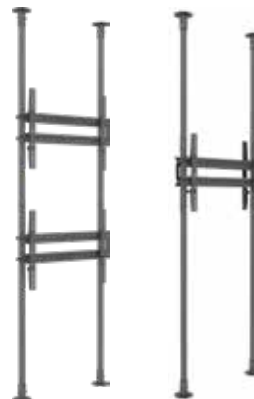

Back to Back possibility

MBFC1UPHD



Single portrait

MBFC2UPD



Back to Back possibility

	MBFC1UHD	MBFC2UHD	MBFC1UPHD	MBFC2UPHD
Model:	MBFC1UHD	MBFC2UHD	MBFC1UPHD	MBFC2UPHD
Recommended screen size:	50" - 90"	50" - 90"	50" - 90"	50" - 90"
VESA & Non-VESA Fixings:	VESA 800, 80cm	VESA 800, 80cm	VESA 900, 90cm	VESA 900, 90cm
EAN:	735007373 7932	735007373 7949	735007373 7956	735007373 7963
Max load:	80kg (Per screen)	80kg (Per screen)	80kg (Per screen)	80kg (Per screen)
Bracket type:	Pole bracket 800x600	Pole bracket 800x600	Pole bracket 600x900	Pole bracket 600x900
Landscape / portrait:	Landscape	Landscape	Portrait	Portrait
Pole length:	310 cm	310 cm	310 cm	310 cm
Colour (VESA arms):	Black	Black	Black	Black
Colour (Horizontal rail):	Black (Silver optional)	Black (Silver optional)	Black (Silver optional)	Black (Silver optional)
Colour (Poles & ceiling mount):	Black	Black	Black	Black
Warranty:	5 years	5 years	5 years	5 years
Accessories:	Cover plates	Cover plates	Cover plates	Cover plates

Solutions for monitors and small size displays.

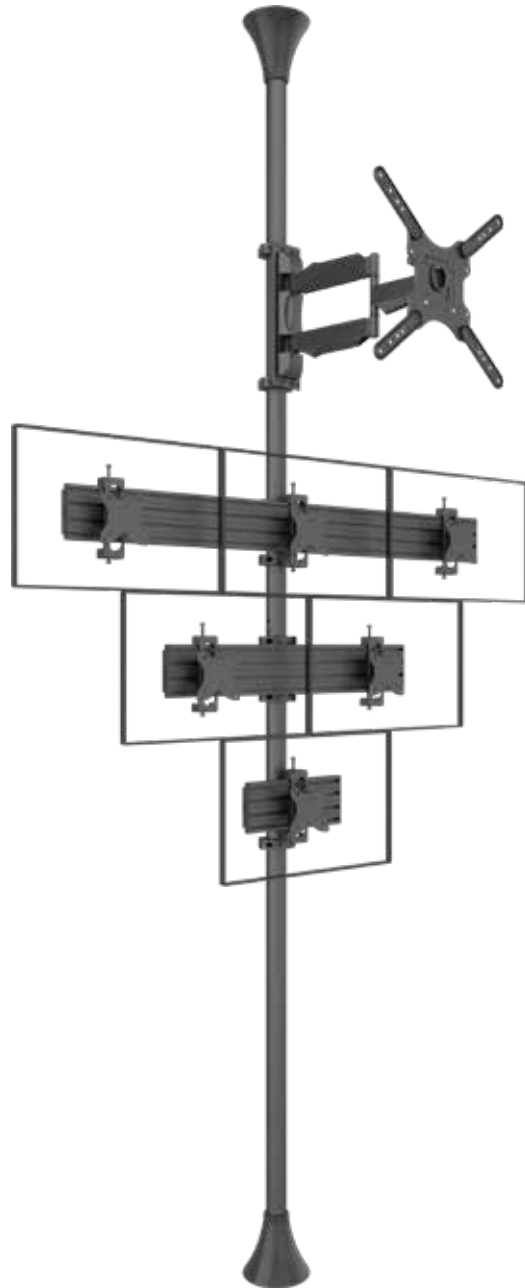

Monitor holders, pole brackets, monitor arms and flex arms.

The line up of M Pro Series Pole Brackets was designed to make it simple to add a display small or large and create tailored installations with the possibility to mix both computer displays with digital signage displays in any possible way imagined.

With the M Pro Series Pole line of brackets it includes a variety of flexible and innovative solutions. From installing a single computer display to a row of computer displays all fitted to the Pro Series 50mm poles.

Floor to ceiling (for monitors)



EAN: 7350105218156



EAN: 7350105218163



EAN: 7350105218170

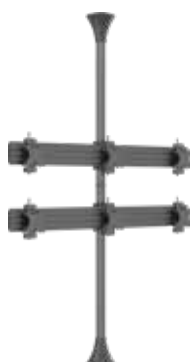

EAN: 7350105212017

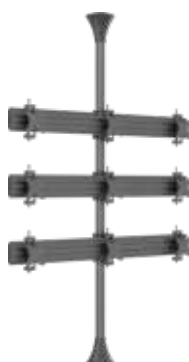

EAN: 7350105212024

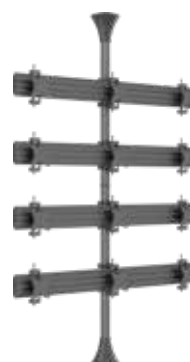

EAN: 7350105212031

Ceiling mount (for monitors)



EAN: 7350105218187



EAN: 7350105218194



EAN: 7350105218200

Wall mount (for monitors)



EAN: 7350105216718



EAN: 7350105216725



EAN: 7350105216732

MBFC2X2U-F100



MBFC3x2U-F100



MBFC3x3U-F100



MBFC3x4U-F100



	MBFC2X2U-F100	MBFC3x2U-F100	MBFC3x3U-F100	MBFC3x4U-F100
Model:	MBFC2X2U-F100	MBFC3x2U-F100	MBFC3x3U-F100	MBFC3x4U-F100
Recommended screen size:	15" - 32"	15" - 32"	15" - 32"	15" - 32"
VESA & Non-VESA Fixings:	50 / 75 / 100mm	50 / 75 / 100mm	50 / 75 / 100mm	50 / 75 / 100mm
EAN:	735010521 2000	735010521 2017	735010521 2024	735010521 2031
Max load:	10kg (Per screen)	10kg (Per screen)	10kg (Per screen)	10kg (Per screen)
Bracket type:	Fixed (Tilt optional)	Fixed (Tilt optional)	Fixed (Tilt optional)	Fixed (Tilt optional)
Landscape / portrait:	Yes	Yes	Yes	Yes
Pole length:	80 cm up to 300 cm	80 cm up to 300 cm	80 cm up to 300 cm	80 cm up to 300 cm
Colour (VESA arms):	Black	Black	Black	Black
Colour (Horizontal rail):	Black (Silver optional)	Black (Silver optional)	Black (Silver optional)	Black (Silver optional)
Colour (Poles & ceiling mount):	Black	Black	Black	Black
Warranty:	5 years	5 years	5 years	5 years
Accessories:	Cover plates	Cover plates	Cover plates	Cover plates

Solutions for turning displays left or right.

Multibrackets Pro Series M Ceiling Mount Pro MBC1F is our innovative line of- ready to be installed Single-Display Ceiling Mount with built in Flexarm.

Now you can use a ceilingmount where you can turn your display left or right.

The new professional Pro Series A/V line from Multibrackets was designed with the installer in mind. Modular, easy to configure, quick to install, and simple to maintain.

Working closely with installers we created a range with close to unlimited flexibility. This model the M Ceiling Mount Pro MBC1F, VESA 200 is no exception.

The product provides the versatility and flexibility demanded by installers. Based upon the Pro Series strong and ultra-flexible 50mm pole it is completely modular and has built in cable management throughout the entire solution to quicken installation and creating an esthetic result worth the public eye.

M Pro Series VESA Flexarm Pro 400

EAN: 735007373 6331

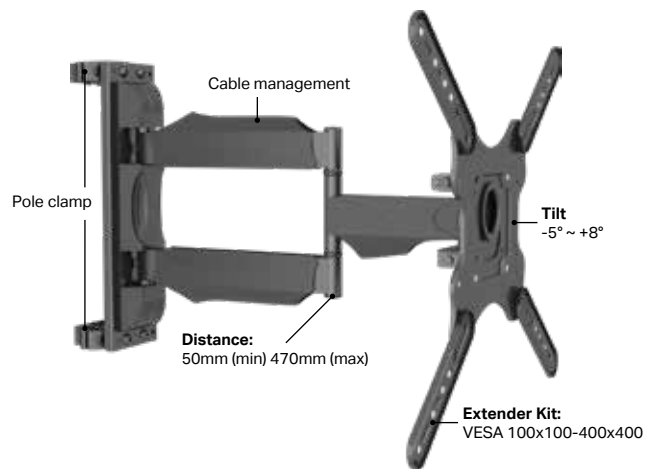

M Pro Series VESA Flexarm Pro 600

EAN: 735010521 2499

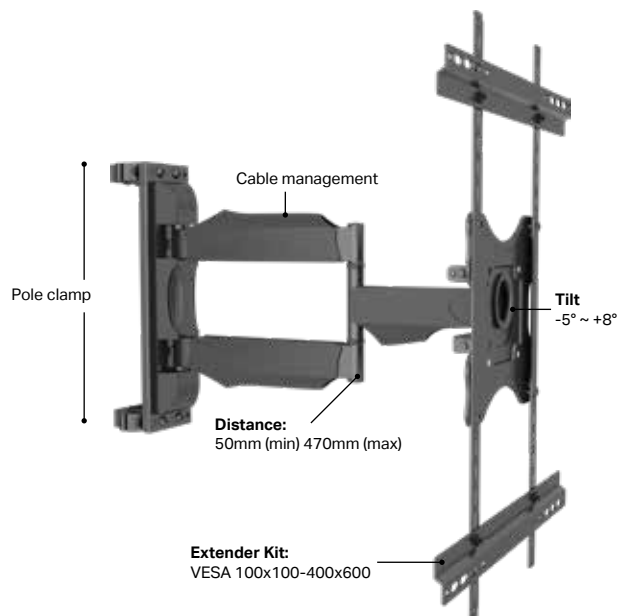

MBFC1F VESA 200

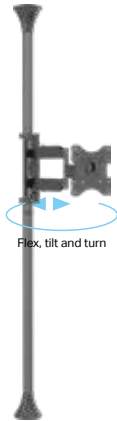

MBFC1F



MBFC1FP



MBC1F VESA 200



MBC1F



MBC1FP



Model:	MBFC1F VESA 200	MBFC1F	MBFC1FP	MBC1F VESA 200	MBC1F	MBC1FP
Recommended screen size:	17" - 42"	42" - 55"	50" - 70"	17" - 42"	42" - 55"	50" - 70"
VESA & Non-VESA Fixings:	VESA 200, 20cm	VESA 400, 40cm	VESA 600, 60cm	VESA 200, 20cm	VESA 400, 40cm	VESA 600, 60cm
EAN:	735007373 6393	735007373 6409	735010521 2505	735007373 6416	735007373 6423	7350105212512
Max load:	35kg (Per screen)	35kg (Per screen)	35kg (Per screen)	35kg (Per screen)	35kg (Per screen)	35kg (Per screen)
Bracket type:	Tilt	Tilt	Tilt	Tilt	Tilt	Tilt
Landscape / portrait:	Yes	Yes	Yes	Yes	Yes	Yes
Pole length:	580 cm up to 300 cm	580 cm up to 300 cm	580 cm up to 300 cm	580 cm up to 300 cm	580 cm up to 300 cm	580 cm up to 300 cm
Colour (VESA arms):	Black	Black	Black	Black	Black	Black
Colour (Horizontal rail):	Black (Silver optional)	Black (Silver optional)	Black (Silver optional)	Black (Silver optional)	Black (Silver optional)	Black (Silver optional)
Colour (Poles & ceiling mount):	Black/ Brass/Chrome/ White	Black/ Brass/Chrome/ White	Black/ Brass/Chrome/ White	Black/ Brass/Chrome/ White	Black/ Brass/Chrome/ White	Black/ Brass/Chrome/ White
Warranty:	5 years	5 years	5 years	5 years	5 years	5 years
Accessories:	Cover plates	Cover plates	Cover plates	Cover plates	Cover plates	Cover plates

Pro Series

CCTV / Camera Ceiling Mounts

For affordable and flexible ceiling installations

The Pro Series line up of CCTV Camera mounts is ideal for retail and commercial environments, where a fixed dome or a fixed box camera need to be installed under high ceilings. The telescopic functionality allows the installer to easily and securely adjust the length of extension between 1m to 6m. The base

of the mount is compatible with the Pro series rails and other accessories. The lightweight and robust ceilingmount can also be installed horizontally on walls as the ceilingmount can be turned 90 degrees when being mounted, making it perfect for an on wall or sloping ceiling installation.

Highlights:

- Works with most CCTV and dome cameras solutions
- Suitable for indoor use
- Perfect for retail and commercial environment
- Extendable between 1.5 to 6 meters
- Lightweight and robust
- Available in black or white colors

Model:	M Ceiling Mount Pro CTV MBC1UX2 VESA 200
Article No:	735010521 6596
Material:	Steel, Aluminium
Color:	Black
Surface Finish:	Powder coating / Anodic Oxidation
Weight:	11 kg
Measurements	82 x 20 x 13 cm
Max Load:	30 kg
Tilt:	90°
Swivel:	360°
Rotate:	0°
Cable Management:	Yes
Warranty:	5 years



CCTV Ceilingmount White



CCTV Ceilingmount



	Model: CCTV Ceilingmount White	CCTV Ceilingmount
Recommended screen size:	For CCTV cameras	For CCTV cameras
VESA & Non-VESA Fixings:	Universal camera mount	Universal camera mount
EAN:	7350105216480	7350105216411
Max load:	30kg	30kg
Pole length:	80 cm up to 150 cm	80 cm up to 150 cm
Colour (VESA arms):	Black	Black
Colour (Horizontal rail):	Black (Silver optional)	Black (Silver optional)
Colour (Poles & ceiling mount):	White	Black
Warranty:	5 years	5 years
Accessories:	Cover plates	Cover plates

CCTV MBC1U White VESA 200



CCTV MBC1UX2 VESA 200



CCTV MBC2X1U VESA 200



	CCTV MBC1U White VESA 200	CCTV MBC1U VESA 200	CCTV MBC1U VESA 200
Model:	CCTV MBC1U White VESA 200	CCTV MBC1U VESA 200	CCTV MBC1U VESA 200
Recommended screen size:	24" - 42"	24" - 42"	24" - 42"
VESA & Non-VESA Fixings:	VESA200 ,20cm	VESA200 ,20cm	VESA200 ,20cm
EAN:	7350105216589	7350105216596	7350105216602
Max load:	30kg	30kg (Per screen)	30kg (Per screen)
Bracket type:	Fixed (Tilt optional)	Tilt (Fixed optional)	Tilt (Fixed optional)
Landscape / portrait:	Yes	Yes	Yes
Pole length:	80 cm up to 150 cm	80 cm up to 150 cm	80 cm up to 150 cm
Colour (VESA arms):	Black	Black	Black
Colour (Horizontal rail):	Black (Silver optional)	Black (Silver optional)	Black (Silver optional)
Colour (Poles & ceiling mount):	White	Black	Black
Warranty:	5 years	5 years	5 years
Accessories:	Cover plates	Cover plates	Cover plates



Pro Series Floor to wall mount

The M Floor to Wall Mount creates a rock steady screen display solution aimed for the retail store, mall or any other public area. 50mm black, brass or chrome tubes can be

tailored to fit the environment the unit is positioned in. Mount screens with tilt or fixed displays. Place them side by side and/or above each other.



	Model: MBFW2P1UHD	MBFW2P1UPHD
Recommended screen size:	65" - 100"	65" - 100"
VESA & Non-VESA Fixings:	800x600mm	600x900mm
EAN:	735010521 6015	735010521 6022
Max load:	125kg	125kg
Bracket type:	Fixed (Tilt optional)	Fixed (Tilt optional)
Landscape / portrait:	Portrait	Yes
Pole length:	80 cm up to 300 cm	80 cm up to 300 cm
Colour (VESA arms):	Black	Black
Colour (Horizontal rail):	Black (Silver optional)	Black (Silver optional)
Colour (Poles & ceiling mount):	Black	Black
Warranty:	5 years	5 years
Accessories:	Cover plates	Cover plates

MBFW1U



MBFW2U



MBFW3U



MBFW3U2U



	Model: MBFW1U	MBFW2U	MBFW3U	MBFW3U2U
Recommended screen size:	32" - 65"	32" - 65"	32" - 65"	32" - 65"
VESA & Non-VESA Fixings:	VESA400, 40cm	VESA400, 40cm	VESA400, 40cm	VESA400, 40cm
EAN:	735010521 4141	735010521 4158	735010521 4165	735010521 4165 (x2)
Max load:	30kg (Per screen)	30kg (Per screen)	30kg (Per screen)	30kg (Per screen)
Bracket type:	Fixed	Fixed	Fixed	Fixed
Landscape / portrait:	Yes	Yes	Yes	Yes
Pole length:	150 cm up to 300 cm	150 cm up to 300 cm	150 cm up to 300 cm	150 cm up to 300 cm
Colour (VESA arms):	Black	Black	Black	Black
Colour (Horizontal rail):	Black (Silver optional)	Black (Silver optional)	Black (Silver optional)	Black (Silver optional)
Colour (Poles & ceiling mount):	Black / Brass / Chrome / White	Black / Brass / Chrome / White	Black / Brass / Chrome / White	Black / Brass / Chrome / White
Warranty:	5 years	5 years	5 years	5 years
Accessories:	Cover plates	Cover plates	Cover plates	Cover plates

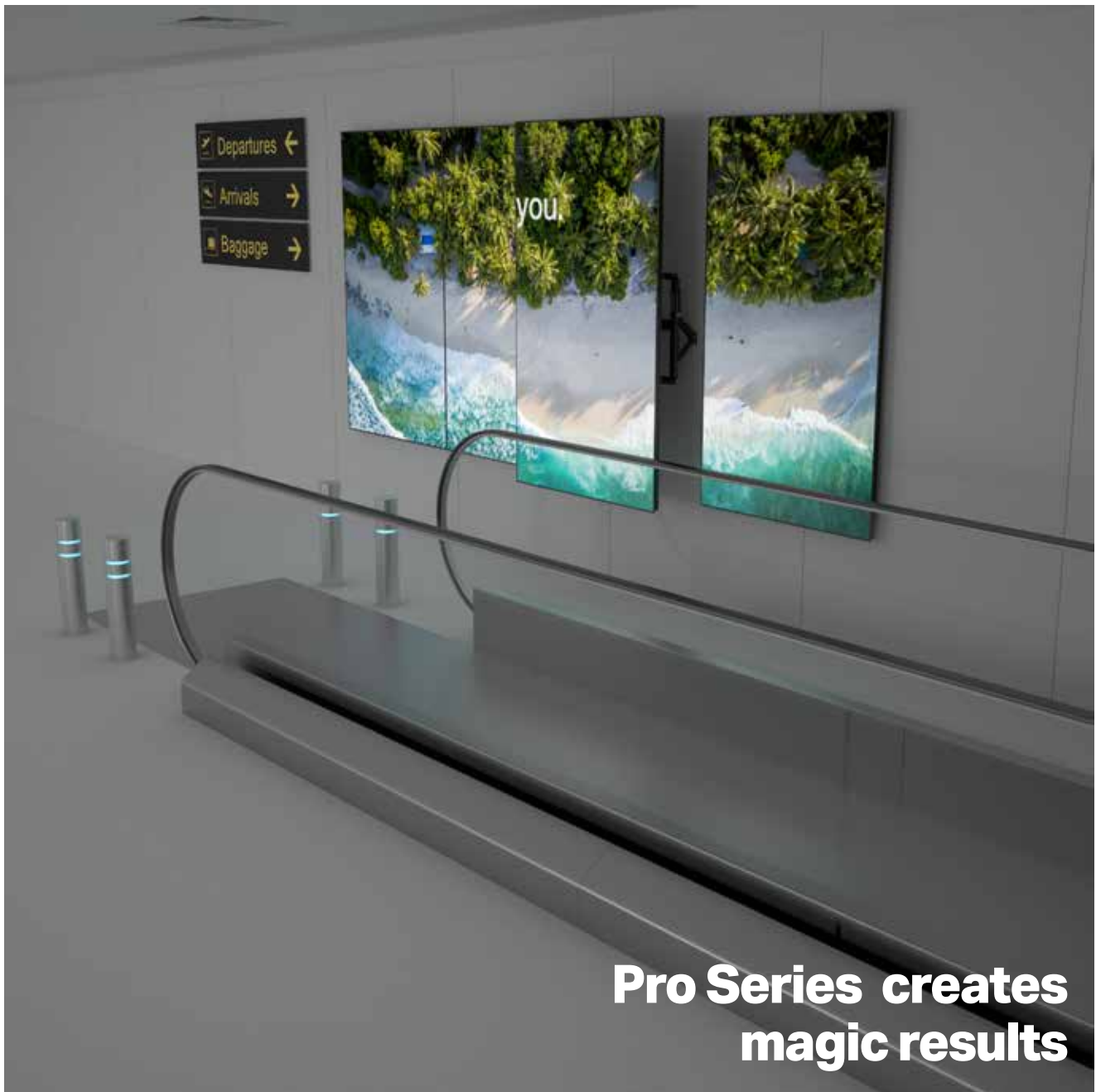

**Pro Series creates
magic results**

Pro Series

Wall mounted solutions

Our Pro Series Wallmounts can be used as menu boards or signage wallmounts. They offer a perfect display positioning and flexible adjustments. The single horizontal extrusion with

optional push in pop out and depth adjustment aligns the displays very quick even on irregular mounting surfaces and allows easy access behind the displays for servicing.

Maximize flexibility Pro Series Wallmounts

For screen in a row the Pro Series now can offer you a simple way to get perfect display positioning and a choice of bracket and adjustment solutions that works after a set standard. Ensuring the very

best installer experience a single aluminum extrusion rail is used with either fixed, tilt or push in pop out brackets that aligns the screens quick and efficiently.

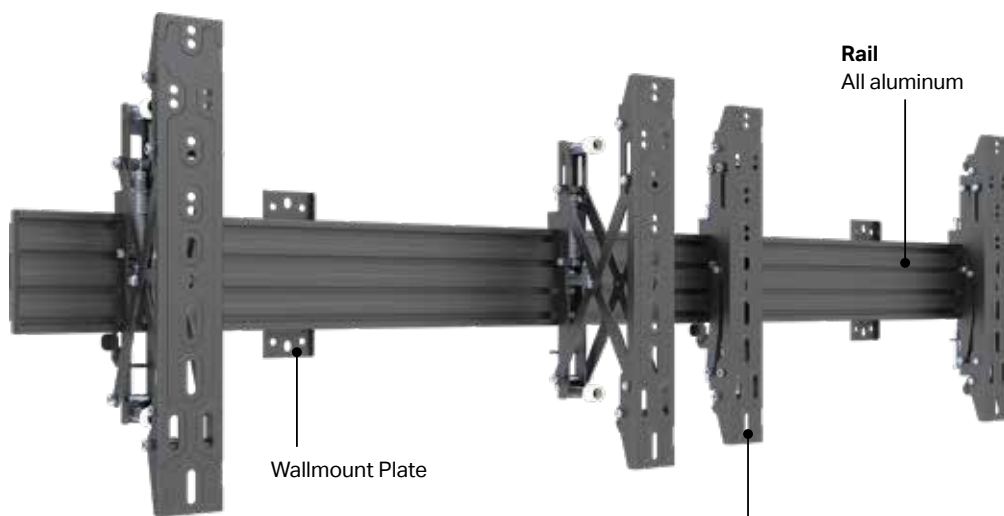

Wallmount Plate

Rail
All aluminum

Exchangable Mounts
Fixed, Tilt, Micro adjustment arms
or Push in Pop out arms

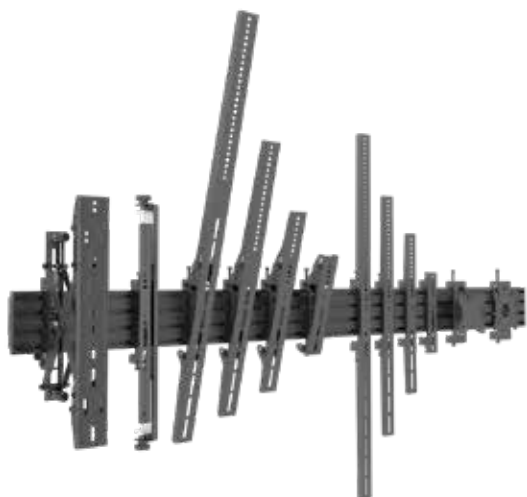

Fixed



Tilt



Micro adjustable arms



Push in pop out arms

Choose between a wide variety of arms:

- Push in pop-out:** 400mm
- Micro adjustable:** 400/ 600mm
- Fixed:** 200/400/600/900mm
- Tilt:** 200/400/600/900mm

MBW1U Tilt 75/100

MBW2U Tilt 75/100

New



Pro Series for monitors
VESA 50/75/100

MBW3U Tilt 75/100

MBW4U Tilt 200 Black



Model:	MBW1U Tilt 75/100	MBW2U Tilt 75/100	MBW3U Tilt 75/100	MBW4U Tilt 200 Black
Recommended screen size:	15"-32"	15"-32"	15"-32"	27"-32"
VESA & Non-VESA Fixings:	75 / 100mm	75 / 100mm	75 / 100mm	VESA 200, 20cm
EAN:	735010521 6718	735010521 6725	735010521 6732	735010521 5971
Max load:	10kg (Per screen)	10kg (Per screen)	10kg (Per screen)	10kg (Per screen)
Bracket type:	Tilt (Fixed optional)	Tilt (Fixed optional)	Fixed (Tilt optional)	Tilt (Fixed optional)
Landscape / portrait:	Yes	Yes	Yes	Yes
Wall distance:	9.3 cm	9.3 cm	--	5.6cm
Colour (VESA arms):	Black	Black	Black	Black
Colour (Horizontal rail):	Black (Silver optional)	Black (Silver optional)	Black (Silver optional)	Black (Silver optional)
Colour (Poles & ceiling mount):	Black	Black	Black	Black
Warranty:	5 years	5 years	5 years	5 years

MBW5U Tilt 200 Black



MBW4X1U VESA 300



MBC4X1U VESA Fixed 300

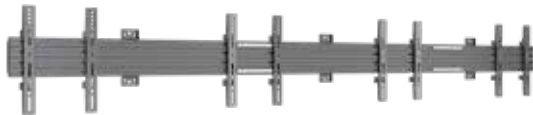

Installation easy as 1-2-3

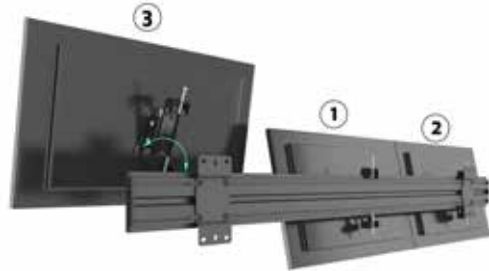

	Model: MBW5U Tilt 200 Black	MBW4X1U VESA 300	MBC4X1U VESA Fixed 300
Recommended screen size:	27"-32"	32"-50"	32"-50"
VESA & Non-VESA Fixings:	VESA200, 20cm	VESA200, 30cm	VESA200, 30cm
EAN:	735010521 5988	735010521 6046	735010521 6213
Max load:	30kg (Per screen)	30kg (Per screen)	30kg (Per screen)
Bracket type:	Tilt (Fixed optional)	Tilt (Fixed optional)	Fixed (Tilt optional)
Landscape / portrait:	Yes	Yes	Yes
Wall distance:	5.6cm	5.6cm	5cm
Colour (VESA arms):	Black	Black	Black
Colour (Horizontal rail):	Black (Silver optional)	Black (Silver optional)	Black (Silver optional)
Colour (Poles & ceiling mount):	Black	Black	Black
Warranty:	5 years	5 years	5 years

MBW1U Fixed 200



MBW2U Fixed 200

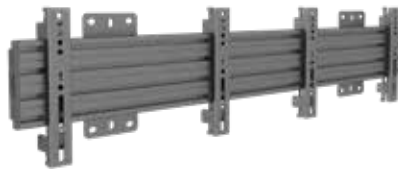

MBW3U Fixed 200

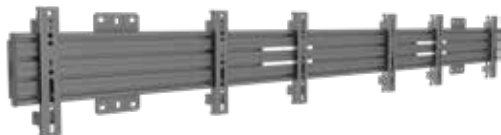

MBW1U Tilt 200



MBW2U Tilt 200



MBW3U Tilt 200



Model name:	MBW1U Fixed 200	MBW2U Fixed 200	MBW3U Fixed 200	MBW1U Tilt 200	MBW2U Tilt	MBW3U Tilt
Recommended screen size:	17" - 42"	27" - 42"	27" - 42"	17" - 42"	40" - 65"	40" - 65"
VESA® & non-VESA fixings:	VESA200 ,20cm	VESA200 ,20cm	VESA200 ,20cm	VESA200 ,20cm	VESA400 ,40cm	VESA400 ,40cm
EAN:	7350073736997	7350073737031	7350073737048	7350073737024	7350073734061	7350073734078
Max load:	30kg	30kg (Per screen)	30kg (Per screen)	30kg (Per screen)	30kg (Per screen)	30kg (Per screen)
Bracket type:	Fixed (Tilt optional)	Fixed (Tilt optional)	Fixed (Tilt optional)	Tilt (Fixed optional)	Tilt	Tilt
Landscape/portrait:	Yes	Yes	Yes	Yes	Yes	Yes
Wall distance:	31.5mm	31.5mm	31.5mm	47.5mm	56cm	56cm
Colour (VESA arms):	Black	Black	Black	Black	Black	Black
Colour (horizontal rail):	Black / Silver	Black / Silver	Black / Silver	Black / Silver	Black (Silver optional)	Black (Silver optional)
Warranty:	5 years	5 years	5 years	5 years	5 years	5 years

MBSTH1U 400x200 Fixed



MBSTH1U 600x200 Fixed

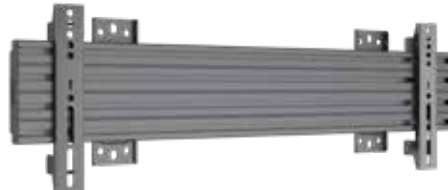

MBW1U Fixed (48cm)



MBW1U Fixed (68cm)



MBW1U Tilt (48cm)



MBW1U Tilt (68cm)



Model name:	MBSTH1U 400x200 Fixed	MBSTH1U 600x200 Fixed	MBW1U Fixed (48cm)	MBW1U Fixed (68cm)	MBW1U Tilt (48cm)	MBW1U Tilt (68cm)
Recommended screen size:	40"-100"	40"-100"	40" - 65"	40" - 75"	40" - 65"	40" - 75"
VESA® & non-VESA fixings:	VESA200 ,20cm	VESA200 ,20cm	VESA400 ,40cm	VESA400 ,40cm	VESA400 ,40cm	VESA400 ,40cm
EAN:	7350073737994	7350073734306	7350105214059	7350073733996	7350105214073	7350073734054
Max load:	80kg	80kg	80kg	80kg	80kg	80kg
Bracket type:	Fixed	Fixed	Fixed	Fixed	Tilt	Tilt
Landscape/portrait:	Portrait	Landscape	Yes	Yes	Yes	Yes
Wall distance:	40 cm	40 cm	40cm	40cm	56cm	56cm
Colour (VESA arms):	Black	Black	Black	Black	Black	Black
Colour (horizontal rail):	Black (Silver optional)	Black (Silver optional)	Black (Silver optional)	Black (Silver optional)	Black (Silver optional)	Black (Silver optional)
Warranty:	5 years	5 years	5 years	5 years	5 years	5 years

MBW2U Tilt 200



MBW3U Tilt 200



MBW2U Fixed



MBW3U Fixed



Portrait

40"-65"

MBSTH1UP 200x400 Fixed



MBSTH1UP 200x600 Fixed



MBW1UP 400x900 Fixed



Model:	MBW2U Tilt 200	MBW3U Tilt 200	MBW2U Fixed	MBW3U Fixed	MBSTH1UP 200x400 Fixed	MBSTH1UP 200x600 Fixed	MBW1UP 400x900 Fixed
Recommended screen size:	27" - 42"	27" - 42"	40" - 65"	40" - 65"	40"-100"	40"-100"	40"-100"
VESA & Non-VESA Fixings:	VESA 200, 20cm	VESA 200, 20cm	VESA 400, 40cm	VESA 400, 40cm	VESA 400, 40cm	VESA 600, 60cm	VESA 900, 90cm
EAN:	735007373 7031	735007373 7048	735007373 4009	735007373 4016	735007373 8007	735007373 4313	735007373 6942
Max load:	30kg (Per screen)	30kg (Per screen)	30kg (Per screen)	30kg (Per screen)	45kg	45kg	90kg
Bracket type:	Tilt (Fixed optional)	Tilt (Fixed optional)	Fixed	Fixed	Fixed	Fixed	Fixed
Landscape / portrait:	Yes	Yes	Yes	Yes	Portrait	Yes	Yes
Wall distance:	47.5mm	47.5mm	40cm	40cm	40cm	40cm	40cm
Colour (VESA arms):	Black	Black	Black	Black	Black	Black	Black
Colour (Horizontal rail):	Black / Silver	Black / Silver	Black (Silver optional)	Black (Silver optional)	Black (Silver optional)	Black (Silver optional)	Black (Silver optional)
Warranty:	5 years	5 years	5 years	5 years	5 years	5 years	5 years

MBW4U Tilt Black



MBW5U Tilt Black



MBW1U Micro Adjustable Black

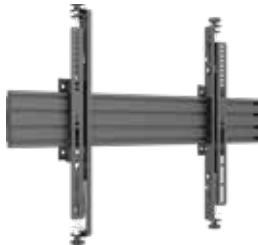

MBW2U Micro Adjustable Black

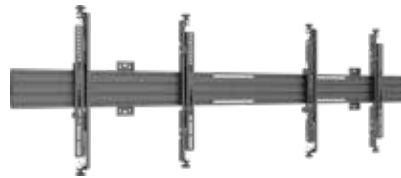

MBW3U Micro Adjustable Black

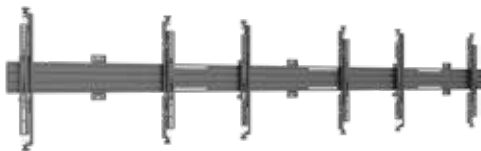

MBW4X1U Push In Pop Out Black



Model:	MBW4U Tilt Black	MBW5U Tilt Black	MBW1U Micro Adjustable Black	MBW2U Micro Adjustable Black	MBW3U Micro Adjustable Black	MBW4X1U Push In Pop Out Black
Recommended screen size:	40" - 65"	40" - 65"	43" - 75"	43" - 65"	43" - 65"	37" - 65"
VESA & Non-VESA Fixings:	VESA400, 40cm	VESA400, 40cm	VESA400, 40cm	VESA400, 40cm	VESA 400, 40cm	VESA 400, 40cm
EAN:	7350105215995	7350105216008	7350105210624	7350105210631	735010521 0648	735010521 3816
Max load:	30kg (Per screen)	30kg (Per screen)	50kg	30kg (Per screen)	30kg (Per screen)	30kg (Per screen)
Bracket type:	Tilt (Fixed optional)	Tilt (Fixed optional)	Micro-Adjustable Arms	Micro-Adjustable Arms	Micro-Adjustable Arms	Push in pop out
Landscape / portrait:	Yes	Yes	Yes	Yes	Yes	Yes
Wall distance:	5.6cm	5.6cm	5.8cm to 7.3cm	5.8cm to 7.3cm	5.6cm	9.1cm to 23.1cm
Colour (VESA arms):	Black	Black	Black	Black	Black	Black
Colour (Horizontal rail):	Black (Silver optional)	Black (Silver optional)	Black (Silver optional)	Black (Silver optional)	Black (Silver optional)	Black (Silver optional)
Colour (Poles & ceiling mount):	Black	Black	Black	Black	Black	Black
Warranty:	5 years	5 years	5 years	5 years	5 years	5 years

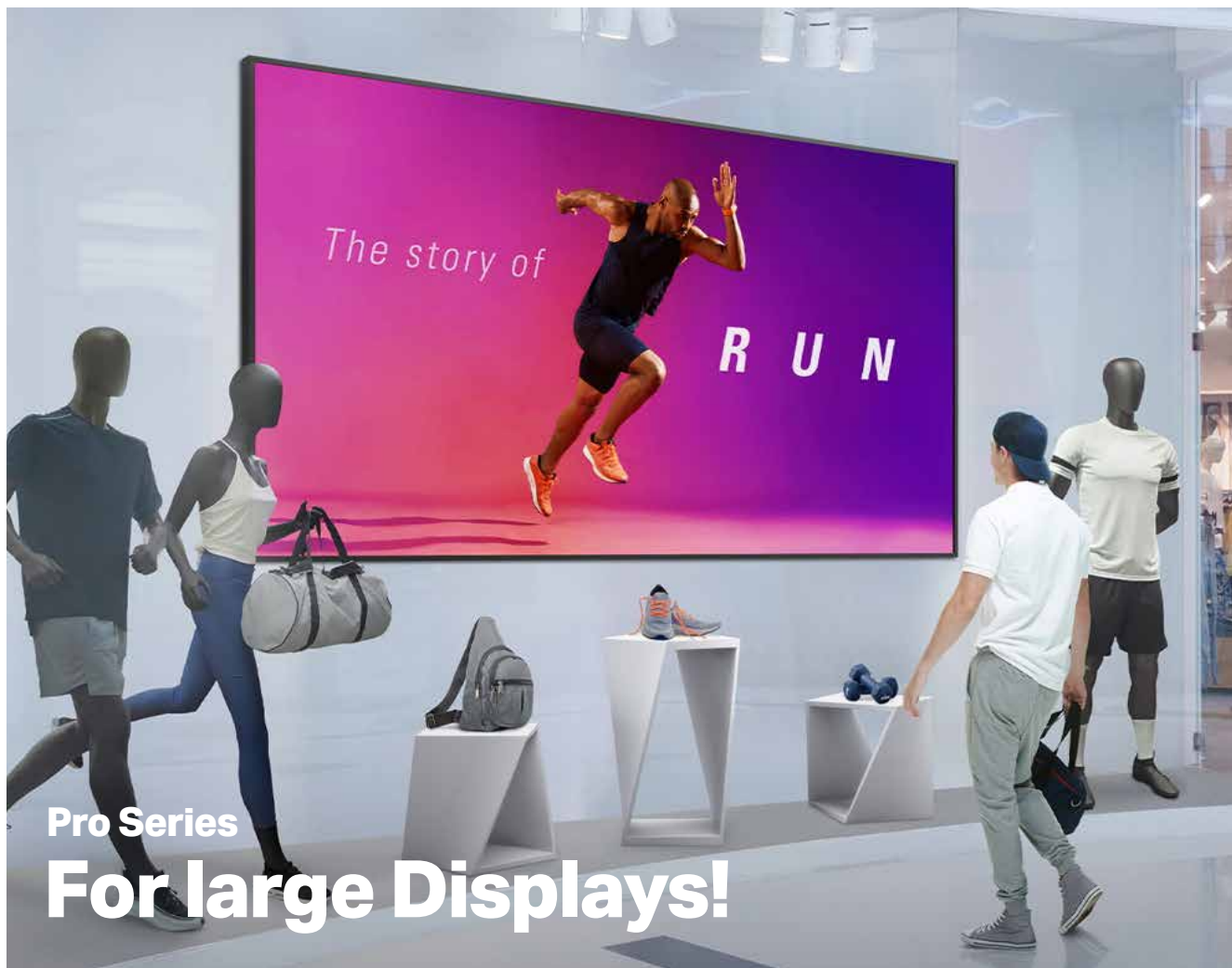

Pro Series
For large Displays!

Our Pro Series Wallmounts can be used as menu boards or signage wallmounts. They offer a perfect display positioning and flexible adjustments. The single horizontal extrusion with

optional push in pop out and depth adjustment aligns the displays very quick even on irregular mounting surfaces and allows easy access behind the displays for servicing.

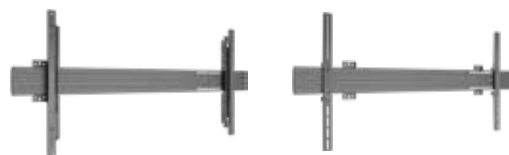

Works well with:
LG 110UM53 & 110UM5K
Iiyama 105" Prolite
...and many more

	MBW1U 1000 Micro Adjustable	MBW1U 1000 Fixed
Model name:	MBW1U 1000 Micro Adjustable	MBW1U 1000 Fixed
Recommended screen size:	46" - 80"	65" - 120"
VESA® & non-VESA fixings:	VESA 600, 60cm	VESA 600, 60cm
EAN:	735010521 4943	735010521 4967
Max load:	70kg	70kg
Bracket type:	Micro Adjustable	Fixed
Landscape/portrait:	Landscape	Landscape
Wall distance:	58mm to 73mm	40cm
Colour (VESA arms):	Black	Black
Colour (horizontal rail):	Black (Silver optional)	Black (Silver optional)
Warranty:	5 years	5 years

MBW1U 1000 Tilt



MBW1U 1000 Micro Adjustable



M Wallmount Pro LG 110UM5 Tilt Black



Model name:	MBW1U 1000 Tilt	MBW1U 1000 Micro Adjustable	Wallmount Pro LG 110UM5 Tilt Black
Recommended screen size:	65" - 120"	65" - 120"	77" - 110"
VESA® & non-VESA fixings:	VESA 600, 60cm	VESA 1000x600mm	VESA 1600x600mm
EAN:	735010521 4950	735010521 4943	735010521 3298
Max load:	70kg	70kg	80kg
Bracket type:	Tilt	Micro-Adjustable Arms 600mm	Tilt (Fixed optional)
Landscape/portrait:	Landscape	Landscape	Landscape
Wall distance:	56cm	7.3cm to 8.8cm	5.6cm
Colour (VESA arms):	Black	Black	Black
Colour (horizontal rail):	Black (Silver optional)	Black (Silver optional)	Black (Silver optional)
Warranty:	5 years	5 years	5 years

Pro Series Wallmounts

Micro adjustable

With the built in fine tune adjustments each of the M Wallmount Pro Micro Adjustable Black can be adjusted individually to match "its neighbouring screens".

With its built in simple to reach knobs, the screens can be adjusted in depth, side and height. What before could take hours for an installer to measure and reinstall, is now fixed in a matter of minutes, Truly an installers dream come true.

Designed with our Scandinavian heritage in mind. Providing a clean Nordic look each part and detail serves its purpose. The result is a sleek Nordic solution emphasizing quality and function.

Used in a variety of environments this ceiling mount is truly versatile and is made of the highest quality materials.

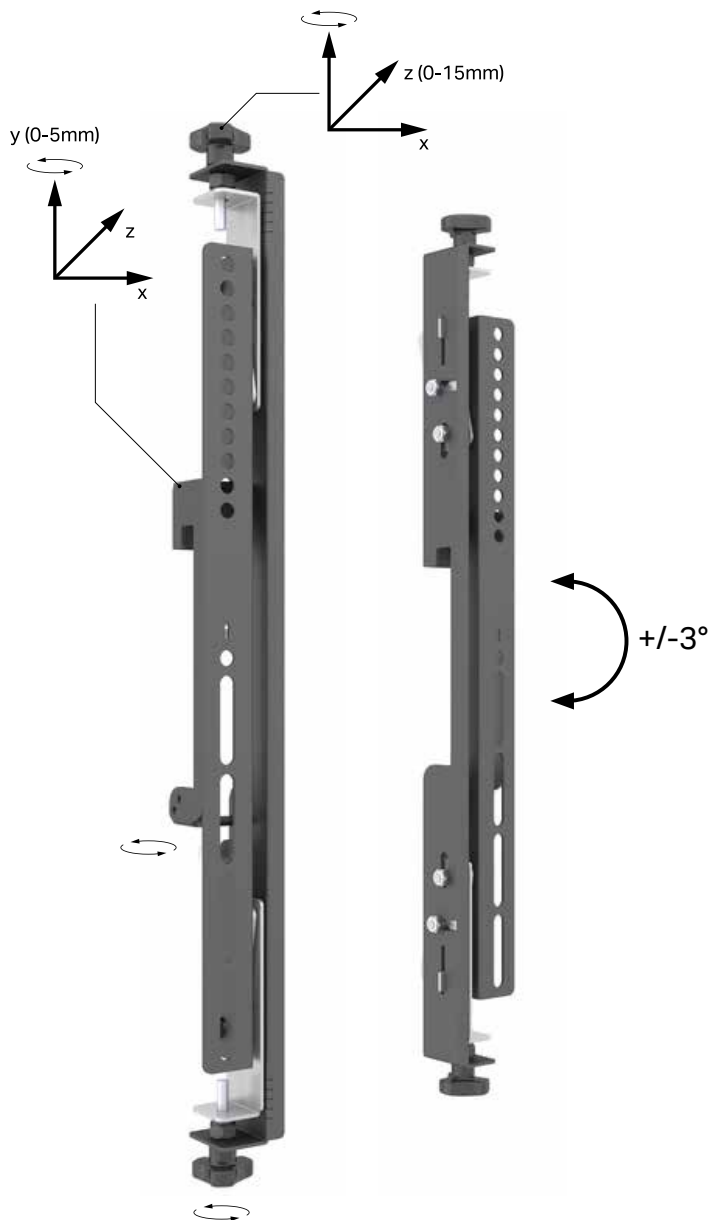

Easy-access to your after-service

Our Micro adjustable wall-mounts also creates easy-access to a display to quick and safe serviceability for sensitive screens with mm precision. This is often one of the major

functions needed when building a video wall mounting solution or when integrating a single screen into the wall.

Portrait installations
 VESA extender kits
 EAN: 7350073734733

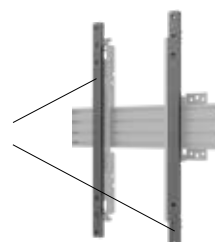

MBW1U 400 (Micro Adjustable)



MBW2U (Micro Adjustable)



MBW3U (Micro Adjustable)

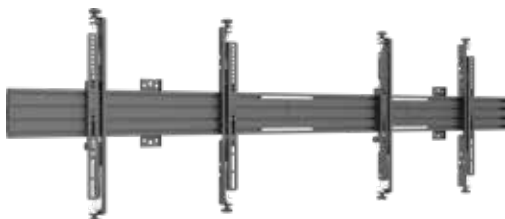

MBW3U (Micro Adjustable)

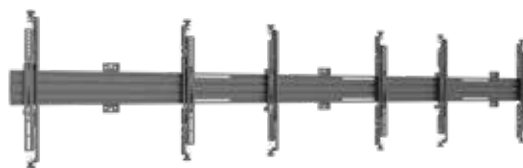

	MBW1U 400 (Micro Adjustable)	MBW1U (Micro Adjustable)	MBW2U (Micro Adjustable)	MBW3U (Micro Adjustable)
Model name:	MBW1U 400 (Micro Adjustable)	MBW1U (Micro Adjustable)	MBW2U (Micro Adjustable)	MBW3U (Micro Adjustable)
Recommended screen size:	43" - 65"	43" - 65"	43" - 65"	43" - 65"
VESA® & non-VESA fixings:	VESA400 ,40cm	VESA400 ,40cm	VESA400 ,40cm	VESA400 ,40cm
EAN:	7350105214080	7350105210624	7350105210631	7350105210648
Max load:	45kg	45kg	30kg (Per screen)	30kg (Per screen)
Bracket type:	Micro Adjustable	Micro Adjustable	Micro Adjustable	Micro Adjustable
Landscape/portrait:	Yes	Yes	Yes	Yes
Wall distance:	58mm to 73mm	58mm to 73mm	58mm to 73mm	58mm to 73mm
Colour (VESA arms):	Black (Silver optional)	Black (Silver optional)	Black (Silver optional)	Black (Silver optional)
Colour (horizontal rail):	Black (Silver optional)	Black (Silver optional)	Black (Silver optional)	Black (Silver optional)
Warranty:	5 years	5 years	5 years	5 years



Add Media Storage to Pro Series Wallmounts

Multibrackets Pro Series solution for integrating a storage tray behind the display. Our M Pro Series Media Storage panel is a component storage slide out panel that facilitates easy access and concealed

mounting of AV equipment behind displays. Now AV equipment can be accessed without the need to remove the display.



Slide in/out

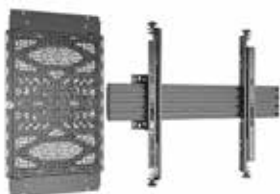

M Pro Series Wallmount MBW1U Media Storage
EAN: 735010521 4332



M Pro Series Wallmount MBW2U Media Storage
EAN: 735010521 4349

Pro Series Large Dual Wallmounted Solutions 65" / 75" / 86"

MBW2UHD Fixed Black

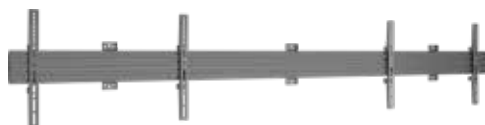

MBW2UHD Tilt Black



MBW2UHD Micro Adjustable Black

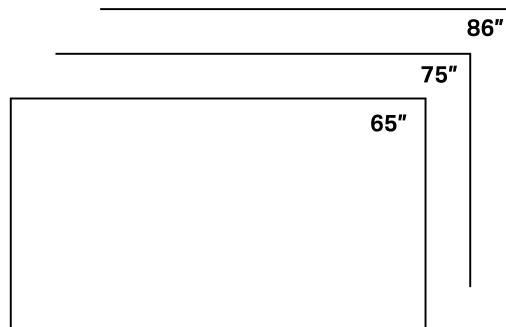

	Model: MBW2UHD Fixed Black	MBW2UHD Tilt Black	MBW2UHD Micro Adjustable Black
Recommended screen size:	75"	75"	75"
VESA & Non-VESA Fixings:	VESA 200, 20cm	VESA 300, 30cm	VESA 300, 30cm
EAN:	7350105215759	7350105215766	7350105215773
Max load:	70kg (Per screen)	70kg (Per screen)	40kg (Per screen)
Bracket type:	Fixed (Tilt optional)	Tilt (Fixed optional)	Micro-Adjustable Arms
Landscape / portrait:	Yes	Yes	Yes
Wall distance:	5.6cm	5.6cm	5.8cm to 7.3cm
Colour (VESA arms):	Black	Black	Black
Colour (Horizontal rail):	Black (Silver optional)	Black (Silver optional)	Black (Silver optional)
Colour (Poles & ceiling mount):	Black	Black	Black
Warranty:	5 years	5 years	5 years
Accessories:	Cover plates	Cover plates	Cover plates

MBW1U Media Storage

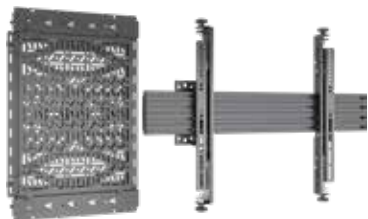

MBW2U Media Storage

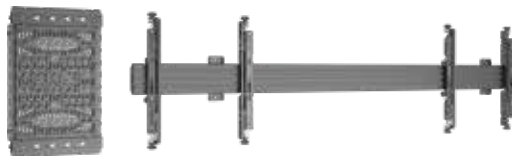

MBW3U Media Storage



Media Storage Slide Panel



	MBW1U Media Storage	MBW2U Media Storage	MBW3U Media Storage	Media Storage Slide Panel
Model name:	MBW1U Media Storage	MBW2U Media Storage	MBW3U Media Storage	Media Storage Slide Panel
Recommended screen size:	65"-120"	46"-65"	46"-65"	---
VESA® & non-VESA fixings:	VESA400,40cm	VESA400,40cm	VESA400,40cm	---
EAN:	7350105214332	7350105214349	7350105214356	7350105213847
Max load:	45kg	30kg (Per screen)	30kg (Per screen)	---
Bracket type:	Micro Adjustable	Micro Adjustable	Micro Adjustable	---
Landscape/portrait:	Landscape	Landscape	Landscape	Yes
Wall distance:	58mm to 73mm	58mm to 73mm	58mm to 73mm	---
Colour (VESA arms):	Black	Black	Black	Black
Colour (horizontal rail):	Black (Silver optional)	Black (Silver optional)	Black (Silver optional)	---
Warranty:	5 years	5 years	5 years	5 years

MBW1U 48cm



MBW2U

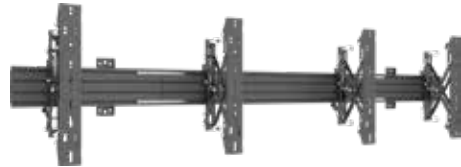

MBW1U 68cm

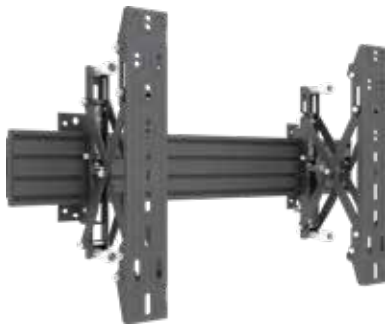

MBW3U



	MBW1U 48cm (Black)	MBW2U (Black)	MBW1U 68cm (Black)	MBW3U (Black)
Model name:	MBW1U 48cm (Black)	MBW2U (Black)	MBW1U 68cm (Black)	MBW3U (Black)
Recommended screen size:	40" - 65"	40" - 65"	40" - 65"	40" - 65"
VESA® & non-VESA fixings:	VESA400 ,40cm	VESA400 ,40cm	VESA400 ,40cm	VESA400 ,40cm
EAN:	7350073735105	7350073734122	7350073734115	7350073734139
Max load:	35kg	30kg (Per screen)	35kg	30kg (Per screen)
Bracket type:	Push in pop out	Push in pop out	Push in pop out	Push in pop out
Landscape/portrait:	Yes	Yes	Yes	Yes
Wall distance:	9.6cm to 22.3cm	9.6cm to 22.3cm	9.6cm to 22.3cm	9.6cm to 22.3cm
Colour (VESA arms):	Black	Black	Black	Black
Colour (horizontal rail):	Black (Silver optional)	Black (Silver optional)	Black (Silver optional)	Black (Silver optional)
Warranty:	5 years	5 years	5 years	5 years

MBW2UX2



MBW2UX3



MBW3X2U

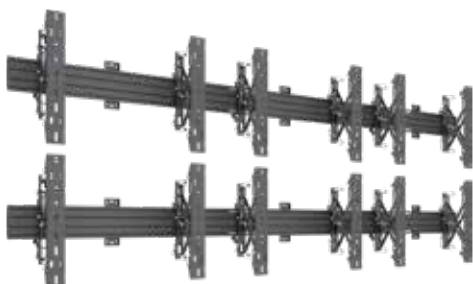

MBW3X3U

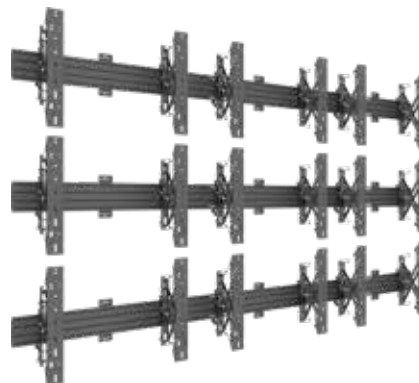

	MBW2UX2 Push In Pop Out	MBW2UX3 Push In Pop Out	MBW3X2U	MBW3X3U
Recommended screen size:	40" - 65"	40" - 65"	40" - 65"	40" - 65"
VESA® & non-VESA fixings:	VESA400,40cm	VESA400,40cm	VESA 400,40cm	VESA 400,40cm
EAN:	7350105212628	7350105212635	7350073735006	7350073735013
Max load:	30kg (Per screen)	30kg (Per screen)	30kg (Per screen)	30kg (Per screen)
Bracket type:	Push in pop out	Push in pop out	Push in pop out	Push in pop out
Landscape/portrait:	Yes	Yes	Yes	Yes
Wall distance:	9.6cm to 22.3cm	9.6cm to 22.3cm	9.6cm to 22.3cm	9.6cm to 22.3cm
Colour (VESA arms):	Black	Black	Black	Black
Colour (horizontal rail):	Black (Silver optional)	Black (Silver optional)	Black (Silver optional)	Black (Silver optional)
Warranty:	5 years	5 years	5 years	5 years

MBW2X1UP

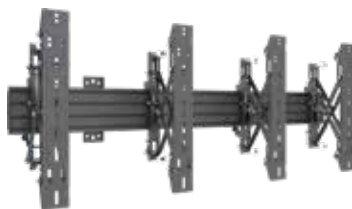

Portrait
32 - 65"

MBW3X1UP



Portrait
32 - 65"

MBW3X2UP

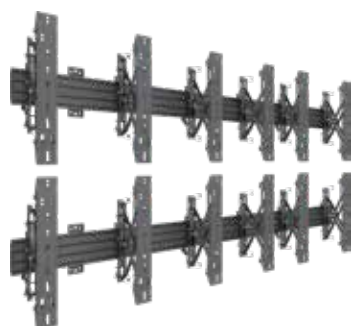

Portrait
32 - 65"

MBW3X3UP

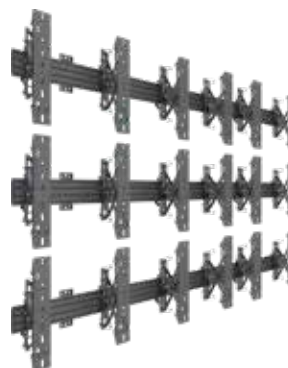

Portrait
32 - 65"

	MBW2X1UP	MBW3X1UP	MBW3X2UP	MBW3X3UP
Model name:	MBW2X1UP	MBW3X1UP	MBW3X2UP	MBW3X3UP
Recommended screen size:	40" - 65"	40" - 65"	40" - 65"	40" - 65"
VESA® & non-VESA fixings:	VESA400 ,40cm	VESA400 ,40cm	VESA400 ,40cm	VESA400 ,40cm
EAN:	7350073735020	7350073735037	7350073735044	7350073735051
Max load:	30kg (Per screen)	30kg (Per screen)	30kg (Per screen)	30kg (Per screen)
Bracket type:	Push in pop out	Push in pop out	Push in pop out	Push in pop out
Landscape/portrait:	Portrait	Portrait	Portrait	Portrait
Wall distance:	9.6cm to 22.3cm	9.6cm to 22.3cm	9.6cm to 22.3cm	9.6cm to 22.3cm
Colour (VESA arms):	Black	Black	Black	Black
Colour (horizontal rail):	Black (Silver optional)	Black (Silver optional)	Black (Silver optional)	Black (Silver optional)
Warranty:	5 years	5 years	5 years	5 years



Pro Series

M Wallmount Column & Column Dual

Innovative - ready to be installed Single or Dual-Display Wallmount on a column. A mounting system which enables you to mount displays on columns without drilling. This is a perfect indoor solution for mounting digital signage displays onto round columns.

These products offer safe and easy installation in landscape and portrait mounting. Ideal for stadiums, arenas, stores and anywhere else column-based mounting is preferred and provides a solution for attaching digital signage displays to various diameter columns.

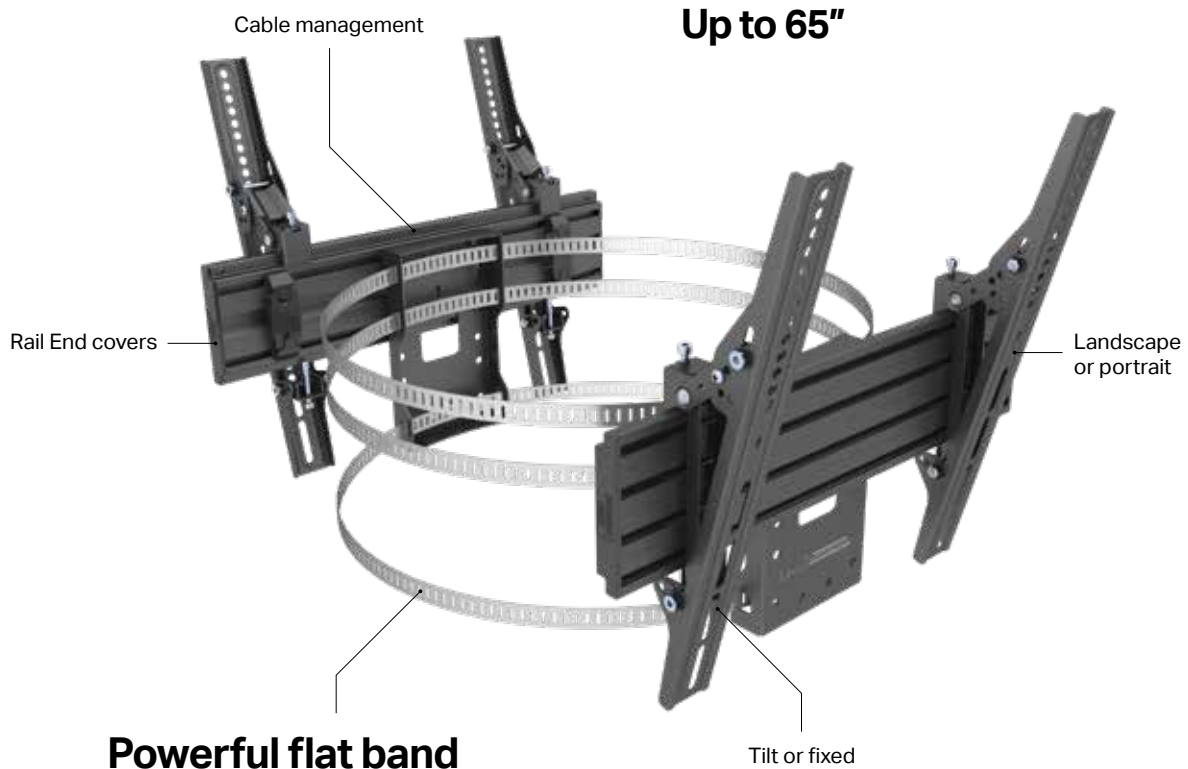

Powerful flat band

Works with squared and round columns

- **Adjustable in size**
- **Min. diameter:** 23cm
- **Max. diameter:** 73cm



Round column



Square column

New!



	M Wallmount Column	M Wallmount Column Dual
Model name:	M Wallmount Column	M Wallmount Column Dual
EAN:	735007373 8458	735010521 3076
For screen size:	32" - 65"	32"-65"
Type:	Single Side MBW1U	Double Side MBW1U
VESA standard:	VESA400,40cm	VESA400,40cm
Material:	Steel, Aluminium	Steel, Aluminium
Max Load:	35 kg (Per screen)	35 kg (Per screen)
Tilt:	Yes, -6~15°	Yes, -6~15°
Warranty:	5 years	5 years



Outdoor Wallmount displays outdoors with elegance and safety

Tailored for Samsung OHF 46", OHF and OHA 55" and OHF 75" outdoor wall mounts with anti-corrosion treatment.

anti-reflection technology, an embedded power box, vandalism protection and a highly efficient cooling system.

The outdoor OHF Series is conveniently and easily installed, designed and operated with a thin, all-in-one solution, which comes in a package which includes ingress protection,

Multibrackets range of tailored OHF Pro Series mounts are a perfect fit. Use the same mount for both landscape and portrait installations.

Samsung

M Pro Series for Samsung OH46/55/75 displays

Choose portrait or landscape mode

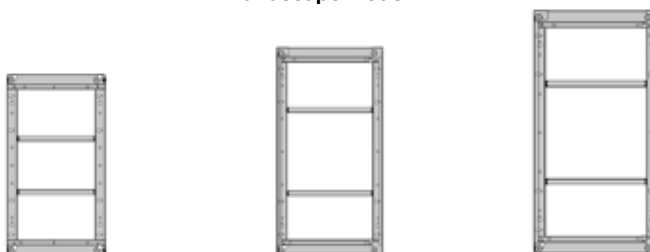

	M Wallmount Pro OH46F/B	M Wallmount Pro OH55F/B/A-S	M Wallmount Pro OH075
For screen size:	46"	55"	75"
VESA standard:	995x500	1186x560	Customized for OH75F
EAN:	7350105214745	7350105214752	7350105215339
Size in cm:	125 x 65 x 9	106 x 59 x 9	200x100x20
Weight:	10.5 kg	12.5 kg	16 kg
Colour:	Black	Black	Black
Warranty:	5 years	5 years	5 years



LG

M Pro Series for LG IP49 and IP55 displays



	M Wallmount Pro LG IP 49 Outdoor	M Wallmount Pro LG IP 55 Outdoor
For screen size:	49"	55"
VESA standard:	995x500	1186x560
EAN:	7350010521 7838	7350010521 7845
Size in cm:	125 x 65 x 9	106 x 59 x 9
Weight:	10.5 kg	12.5 kg
Colour:	Black	Black
Warranty:	5 years	5 years



Smart Signage Outdoor Totems

Samsung OHF Series 46"/ 55"/ 75"/ 85"

LG XE4F Series 49"/55"

A powerful all-inclusive signage solution for outdoor business messaging.

Increase drive-thru sales and promote order efficiency with Multibrackets universal Outdoor Digital Menu Boards, designed to support Samsungs 46"/ 55"/ 75" and 85" outdoor displays. These all-weather rated, outdoor units offer a low operating cost, modular design, and simple installation. Multibrackets Totems for the Samsung's OHF Series SMART Signage delivers an all-inclu-

sive engagement solution that is completely equipped for virtually any outdoor environment. Combined with the OHF Series displays ensure durability, flexibility and 24/7 performance even in extreme temperatures.

By making the switch to digital with Multibrackets Outdoor Digital Totems together with the LG ZE4F Series, your clients will no longer need to manually update static menu content throughout the day. Instead, the digital content can be updated remotely and in real-time. Now you can

create a seamless drive-thru experience for customers and a your restaurant will become more efficient. With the slim & robust design the XE4F series from LG can be combines in Multibrackets outdoor totems and simplified integration for your partner's customized design is then possible.

Highlights:

- . **Made in Europe**
- . **Slim depth**
- . **Easy access**
- . **Tailormade height possible**
- . **Top level materials**
- . **Easy installation**



	M Totem Pro Single OH55F/B/A-S	M Totem Pro Dual OH55F/B/A-S	M Totem Pro Triple OH55F/B/A-S
For screen size:	55"	55"	55"
VESA standard:	560x1186mm	560x1186mm	560x1186mm
EAN:	735002273 6580	735002273 6597	735002273 6603
Colour:	Black	Black	Black
Warranty:	5 years	5 years	5 years



	M Totem Pro Single 55XE4F-M	M Totem Pro Dual 55XE4F-M	M Totem Pro Triple 55XE4F-M	M Totem Pro Single 49XE4F-M
For screen size:	55"	55"	55"	49"
VESA standard:	LG proprietary fitting	LG proprietary fitting	1186x560	LG proprietary fitting
EAN:	735010521 6978	735010521 6985	735010521 6992	735010521 8101
Colour:	Black	Black	Black	Black
Warranty:	5 years	5 years	5 years	5 years



Made in EU

Hergestellt nach europäischen Qualitätsstandards

PRO SERIES

M Pro Series Rails

Function and freedom for the installer

The Pro Series horizontal mounting rails are the central component of any Pro Series product whether it be wall-mount menuboard or a single screen ceilingmount.

Made from high grade aluminium, the rail itself is sturdy yet lightweight and is designed to support a variety of interface arms and mounts, allowing monitors, screens and other AV equipment to be fitted onto the rail.

Our Rails are available in packaged solutions of lengths, 28cm, 48cm, 68cm, 100cm, 196cm, 348cm. It can be mounted on Pro Series columns, poles and wallbrackets.

The Rails can be cut to shorter lengths as required or joined together using extension kits to reach the right length for your installation.

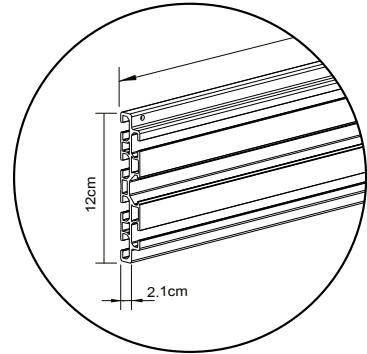

Modular design

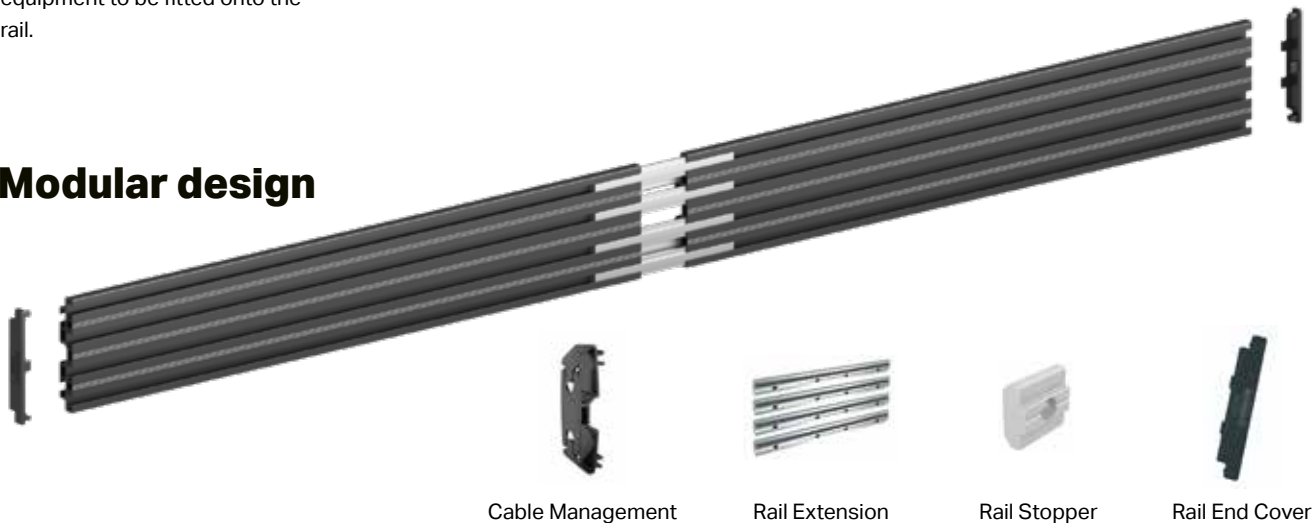

Cable Management

Rail Extension

Rail Stopper

Rail End Cover

Universal Monitor Interface Mounts

FIXED VERSION

10mm height adj.



EAN: 7350073736300

TILT VERSION

10mm height adj.



10mm height adj.

Rotation 360°

VESA 75x75 to 100x100mm

Tilt -12° ~ +12°

EAN: 7350073736294

Universal Interface Arms

Fixed



**M Pro Series
Fixed Arms 200mm**



**M Pro Series
Fixed Arms 400mm**



**M Pro Series
Fixed Arms 600mm**



**M Pro Series
Fixed Arms 900mm**

EAN:	7350073733903	7350073733736	7350073733750	7350073733774
Material:	Steel	Steel	Steel	Steel
Weight:	1.5 kg (pcs)	2.2 kg (2pcs)	3 kg (2pcs)	5 kg (2pcs)
Size:	230x35x33 mm	430x35x33 mm	630x35x33 mm	930x35x30 mm
Max load:	30 kg / screen	30 kg / screen	30 kg / screen	30 kg / screen

Tilt



**M Pro Series
Tilt Arms 200mm**



**M Pro Series
Tilt Arms 400mm**



**M Pro Series
Tilt Arms 600mm**



**M Pro Series
Tilt Arms 900mm**

EAN:	7350073733910	7350073733743	7350073733767	7350073733781
Material:	Steel	Steel, aluminum	Steel	Steel
Weight:	3 kg (pcs)	3.5 kg (pcs)	5 kg (2pcs)	6.5 kg (2pcs)
Size:	230x68.5x39 mm	430x68.5x39 mm	630x68.5x39 mm	930x68.5x39 mm
Max load:	30 kg / screen	30 kg / screen	30 kg / screen	30 kg / screen

Push in Pop out



**M Pro Series
M Push in Pop out
VESA 400**



**M Pro Series
M Push in Pop out Arms
600 mm**



**M Pro Series
Micro-Adjustable Arms
400mm**



**M Pro Series
Micro-Adjustable Arms
600mm**

EAN:	7350073734726	7350105210464	7350073733798	7350105210457
Material:	Steel	Steel	Steel	Steel
Weight:	4.5 kg (pcs)	4.5 kg (pcs)	5 kg (pcs)	3.5 + 4.3 kg (2 pcs)
Size:	455x165x80 mm	950x110x88 mm	543x49x47 mm	655x120x72 mm
Max load:	30 kg / screen	30 kg / screen	30 kg / screen	30 kg / screen

Micro adjustable



Pro Series Wallmounts From Wall / Wall to Wall

Inform with high visibility

In the need of solutions to mount displays in a perpendicular position to a wall? The M Pro Series From Wall and Wall to Wall models are our innovative interior designed Pro Series solutions that offers high

visibility in open areas such as hallways, concourses, aisles and office spaces. The bracket mounts vertically so that the display is presented perpendicular to walls or between two walls. The clean and simple

Scandinavian design has a durable construction and is very easy to install, a complete set of hardware is included. The M Pro Series From Wall and Wall to Wall series is a single or double sided solution.

This digital signage installation makes it easy to keep moving crowds informed and this type of fixture is an ideal way to display high visibility wayfinding or directional information in high traffic areas.

MBFW1U VESA200



MBFW1U



MBFW1UX2



MBWW1U Fixed (125cm)



MBWW2U Fixed (200cm)



MBWW3U Fixed (300cm)



Model name:	MBFW1U VESA200	MBFW1U	MBFW1UX2	MBWW1U Fixed (125cm)	MBWW2U Fixed (200cm)	MBWW3U Fixed (300cm)
Recommended screen size:	17" - 42"	42"-65"	42"-65"	32"-75"	32"-75"	32"-75"
VESA® & non-VESA fixings:	VESA200 ,20cm	VESA400 ,40cm	VESA400 ,40cm	VESA400 ,40cm	VESA400 ,40cm	VESA400 ,40cm
EAN:	7350073737666	7350073737642	7350073737659	7350073737826	7350073737833	7350073737840
Max load:	30kg (Per screen)	30kg (Per screen)	30kg (Per screen)	40kg	30kg (Per screen)	30kg (Per screen)
Bracket type:	Fixed	Fixed	Fixed	Fixed	Fixed	Tilt
Landscape/portrait:	Yes	Yes	Yes	Yes	Yes	Yes
Colour (VESA arms):	Black	Black	Black	Black	Black	Black
Colour (horizontal rail):	Black (Silver optional)	Black (Silver optional)	Black (Silver optional)	Black (Silver optional)	Black (Silver optional)	Black (Silver optional)
Warranty:	5 years	5 years	5 years	5 years	5 years	5 years

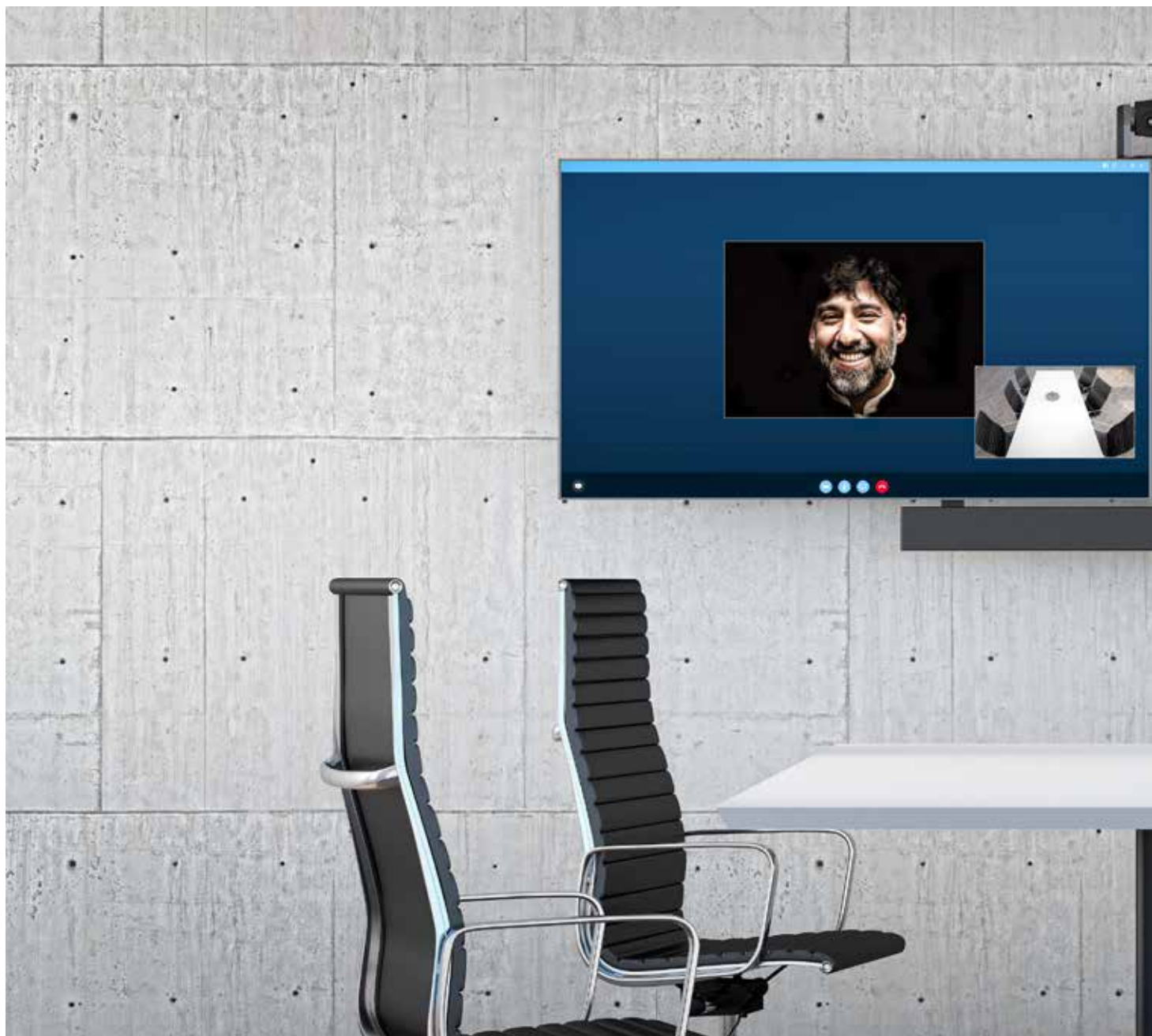

Pro Series Collaboration Video conference

With proper videoconferencing you can expand your collaboration efforts. Use video conferencing to meet face-to-face over distance, helping to build trust and speed decision mak-

ing. You will also reduce travel costs. To be able to work from anywhere, interact with peers around the world, and attend online training sessions over video. With Multibrackets Pro

Series Collaboration solutions you will simplify video conference for your meetingrooms, offices and optimize communication with people anytime, anywhere.



Max length 1705mm



Min length 1025mm

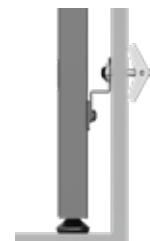

Gypsum Wall Expansion Nails

Can be used with or without supportive legs

Collaboration MBW1U

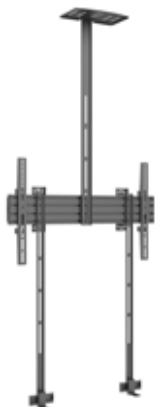

Collaboration Side by Side 65"



Collaboration Side by Side 75"

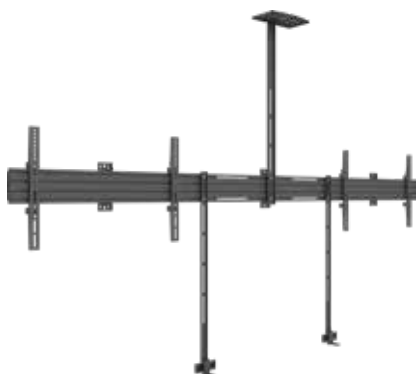

Collaboration Side by Side 90"



Model name:	Collaboration MBW1U	Collaboration Side by Side 65"	Collaboration Side by Side 75"	Collaboration Side by Side 90"
Recommended screen size:	32" - 75"	32" - 65"	32" - 75"	32" - 90"
VESA® & non-VESA fixings:	VESA400,40cm	VESA400,40cm	VESA400,40cm	VESA400,40cm
EAN:	7350105212840	7350073736621	7350073738915	7350073738922
Max load:	70kg	30kg (Per screen)	70kg (Per screen)	70kg (Per screen)
Bracket type:	Fixed	Fixed	Fixed	Fixed
Landscape/portrait:	Landscape	Yes	Yes	Yes
Wall distance:	40cm	40cm	40cm	40cm
Colour (VESA arms):	Black	Black	Black	Black
Colour (horizontal rail):	Black (Silver optional)	Black (Silver optional)	Black (Silver optional)	Black (Silver optional)
Warranty:	5 years	5 years	5 years	5 years

Collaboration MBW1U with Floor support



Collaboration Side by Side 65" with Floor support



Collaboration Side by Side 75" with Floor support

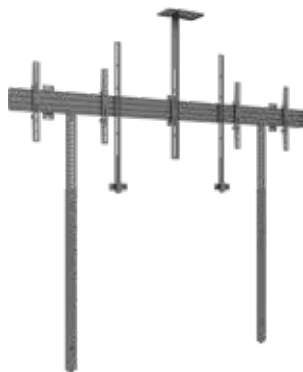

Collaboration Side by Side 90" with Floor support

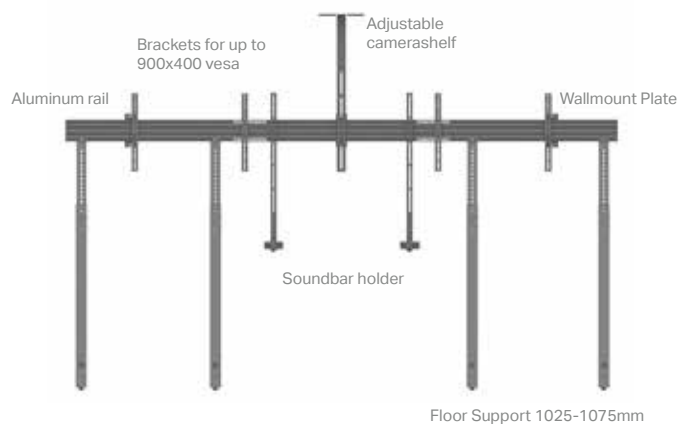

Model name:	MBW1U with Floor support	SBS 65" with Floor support	SBS 75" with Floor support	SBS 90" with Floor support
Recommended screen size:	32" - 75"	32" - 65"	32" - 75"	32" - 90"
VESA® & non-VESA fixings:	VESA400 ,40cm	VESA400 ,40cm	VESA400 ,40cm	VESA400 ,40cm
EAN:	7350105213960	7350105213977	7350105213984	7350105213991
Max load:	70kg	30kg (Per screen)	70kg (Per screen)	70kg (Per screen)
Bracket type:	Fixed	Fixed	Fixed	Fixed
Landscape/portrait:	Landscape	Yes	Yes	Yes
Floor support:	40cm	40cm	40cm	40cm
Wall distance:	1025-1705mm	1025-1705mm	1025-1705mm	1025-1705mm
Colour (VESA arms):	Black	Black	Black	Black
Colour (horizontal rail):	Black (Silver optional)	Black (Silver optional)	Black (Silver optional)	Black (Silver optional)
Warranty:	5 years	5 years	5 years	5 years



Pro Series

Communication Stations

M Floorstand Pro MBF1U 150 & MBF1U 180

Introducing the M Floorstand Pro MBF1U 150 a flat panel TV cart that was designed to include all of the features you may need, making it perfect for any application. Mobility, appealing design, display height adjustment, pre-assembled base and safety certifications ensure quick assembly while providing a ridged, but attractive and structured that fits into any decor.



Highlights:

- Mobile and ultra flexible
- Integrated cable management
- All parts provides rigidity, stability and quick assembly
- Textured black powder coat finish
- Universal and extendable mounting up to VESA 1000x900mm
- If your needs change reconfigure your floorstand
- 5-year warranty

Example configurations

Configure or reconfigure after your current or future needs.
Our Pro Series Floorstands can change with you as your needs change.

All modular

MBF1U



MBF1U with soundbar and camera mount



MBFSC-Single



MBFSC 150cm



MBFSC 180cm



Model name:	MBF1U without shelf	MBF1U with soundbar mount	MBFSC-Single	MBFSC 150cm	MBFSC 180cm
Recommended screen size:	48" - 55", 24" - 27"	75"~100"	55" - 65", 27" - 32"	48" - 55", 24" - 27"	55" - 65", 27" - 32"
VESA® & non-VESA fixings:	1000x600mm	1000x600mm	100x100-400x400, 75x75-100x100mm	100x100-400x400, 75x75-100x100mm	100x100-400x400, 75x75-100x100mm
EAN:	---	---	---	---	---
Max load:	90kg	90kg	45kg, 8kg	45kg, 8kg (Per screen)	45kg, 15kg (Per screen)
Bracket type:	Fixed	Fixed	Tilt	Tilt	Tilt
Landscape/portrait:	Yes	Yes			Yes
Pillar length:	150/180cm	150/180cm	150cm	150cm	180cm
Colour (VESA arms):	Black	Black	Black	Black	Black
Colour (horizontal rail):	Black	Black	Black	Black	Black
Colour (pillar & legs):	Black	Black	Black	Black	Black
Warranty:	5 years	5 years	5 years	5 years	5 years

MBF1UXL 270

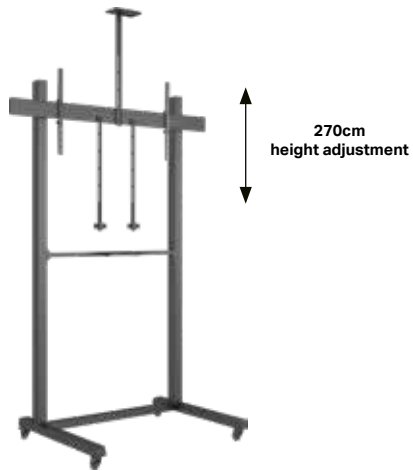

Side by Side 65"



Side by Side 75"



Side by Side 90"



	Model: MBF1UXL 270	Side by Side 65"	Side by Side 75"	Side by Side 90"
Recommended screen size:	98"-110"	40"-65"	40"-65"	40"-65"
VESA & Non-VESA Fixings:	1000x600mm	VESA 400, 40cm	VESA 400, 40cm	VESA 400, 40cm
EAN:	7350105217111	7350105216183	7350105216190	7350105216206
Max load:	50kg	30kg (Per screen)	30kg (Per screen)	30kg (Per screen)
Bracket type:	Fixed (Tilt optional)	Fixed (Tilt optional)	Fixed (Tilt optional)	Fixed (Tilt optional)
Landscape / portrait:	Yes	Yes	Yes	Yes
Pillar length:	270 cm	180 cm	180 cm	300 cm
Colour (VESA arms):	Black	Black	Black	Black
Colour (Horizontal rail):	Black (Silver optional)	Black (Silver optional)	Black (Silver optional)	Black (Silver optional)
Colour (Pillar):	Black	Black	Black	Black
Warranty:	5 years	5 years	5 years	5 years



	M Pro Series - Tripod Stand 32"-75"	M Pro Series - Tripod Stand B2B 32"-75"
EAN:	735010521 7425	7350105217432
Color:	Black	Black
For screen size:	Steel, Aluminium	Steel, Aluminium
Universal & VESA standard:	75x75 100x100 200x200	75x75 100x100 200x200 400x400
Material:	Steel, Aluminium, Plastic	Steel, Aluminium, Plastic
Surface Finish:	Powder coating	Powder coating
Weight:	13 kg	17 kg
Measurements	154.5 x 23 x 23 cm	154.5 x 23 x 23 cm
Max Load:	30 kg per screen	30 kg per screen
Height:	10 mm height adjustment	10 mm height adjustment
Installation:	M Pro Series	M Pro Series
Warranty:	5 years	5 years



Pro Series Floorstands Single Pole

The new range of Pro Series single pole flat panel floorstands are designed to provide the ideal display viewing placement and match the décor of any environment. Ideal for public areas like stores, training rooms, lobbies, classrooms,

auditoriums, or exhibition halls. As with all Pro series products a full line-up of accessories offering tailor possibilities functionality to meet your specific requirements. Internal cable management hides the AV cabling, showing a clean look.





Pro Series Floorstands

Dual Pole

The Dual Pole range of Pro Series floorstands designed to support one or two large size screens mounted back-to-back in either landscape or portrait. Simple to install, clean and attractive design, yet very robust and functional the Dual Pole series is ideal for a wide variety of applications and settings. Designed to provide the ideal display viewing placement and match the décor of any environ-

ment. Ideal for public areas like stores, training rooms, lobbies, classrooms, auditoriums, or exhibition halls. As with all Pro series products a full line-up of accessories offering tailor possibilities functionality to meet your specific requirements. Internal cable management hides the AV cabling, showing a clean look.



Single Pole Floormount





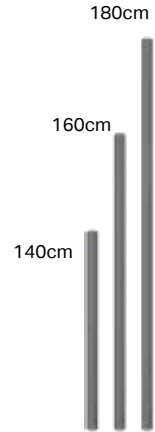

Single Pole Floorbase



Optional round base
EAN: 735010521 7593

Pole colors:

-  Black
-  Chrome
-  White
-  Brass
-  Tailored

	M Single Pole Floormount Pro 32"-65"	M Single Pole Floorbase Pro 32"-65"
EAN:	Black: 7350073738939	Black: 7350073738946
Color:	Black	Black
Optional colour:	Chrome, White, Brass, Tailored	Chrome, White, Brass, Tailored
Color:	Black / Chrome / White	Black / Chrome / White
For screen size:	32"-65"	Steel, Aluminium, Plastic
Universal & VESA standard:	100x100 200x200 300x300 400x400	100x100 200x200 300x300 400x400
Material:	Steel, Aluminium, Plastic	Steel, Aluminium, Plastic
Surface Finish:	Powder coating	Powder coating
Weight:	11 kg	25 kg 11 kg
Measurements	160*18*15 cm	90x62x4 & 160x18x15 cm
Max Load:	50 kg per screen	50 kg per screen
Height:	10 mm height adjustment	10 mm height adjustment
Tilt:	-6°~+15°	-6°~+15°
Warranty:	5 years	5 years

M Dual Pole Floormount Pro 65"-90"



M Dual Pole Floorbase Pro 65"-90"



M Dual Pole Floormount Pro B2B 65"-90"



M Dual Pole Floorbase Pro B2B 65"-90"



	M Dual Pole Floormount Pro	M Dual Pole Floorbase Pro	M Dual Pole Floormount Pro B2B	M Dual Pole Floorbase Pro B2B
EAN:	7350073738953	7350073738960	7350073738977	7350073738984
Color:	Black	Black	Black	Black
Optional colour:	Chrome, White, Brass, Tailored	Chrome, White, Brass, Tailored	Chrome, White, Brass, Tailored	Chrome, White, Brass, Tailored
For screen size:	65"-90"	65"-90"	65"-90"	65"-90"
Universal & VESA standard:	100x100 200x200 300x300 400x400 400x600	100x100 200x200 300x300 400x400 400x600	100x100 200x200 300x300 400x400 400x600	100x100 200x200 300x300 400x400 400x600
Material:	Steel, Aluminium, Plastic	Steel, Aluminium, Plastic	Steel, Aluminium, Plastic	Steel, Aluminium, Plastic
Surface Finish:	Powder coating	Powder coating	Powder coating	Powder coating
Weight:	15.7 kg	15.7 kg & 25 kg	21 kg	21KG&25 kg
Measurements	160*18*15 cm	160*18*15 & 90*62*4 cm	160*18*15 cm	160*18*15 & 90*62*4 cm
Max Load:	75 kg per screen	75 kg per screen	75 kg per screen	75 kg per screen
Height:	10 mm height adjustment	10 mm height adjustment	10 mm height adjustment	10 mm height adjustment
Tilt:	-6°~+15°	-6°~+15°	-6°~+15°	-6°~+15°
Warranty:	5 years	5 years	5 years	5 years



New!

Pro Series

Floorstands

Triple & Quad

With the unique modular set up the Pro Series range of floorstand's designed to support one, two, three or more screens mounted in most ways imaginable in either landscape or portrait. Simple to install, clean and attractive design, yet very robust and functional the Dual Pole series is ideal for a wide variety of applications and settings. Designed to provide the ideal display viewing placement

and match the décor of any environment. Ideal for public areas like stores, training rooms, lobbies, classrooms, auditoriums, or exhibition halls. As with all Pro series products a full line-up of accessories offering tailor possibilities functionality to meet your specific requirements. Internal cable management hides the AV cabling, showing a clean look.



Triple Pro MBF3U



Triple Pro AddOn MBF3U

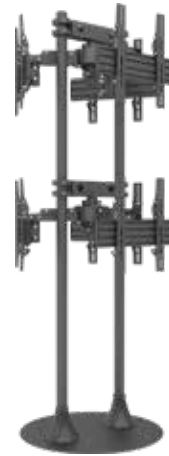

Quad Pro MBF4U

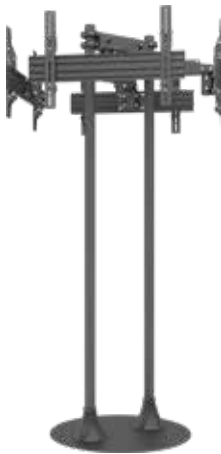

Quad Pro AddOn MBF4U



	Triple Pro MBF3U	Triple Pro AddOn MBF3U	Quad Pro MBF4U	Quad Pro AddOn MBF4U
Model name:	Triple Pro MBF3U	Triple Pro AddOn MBF3U	Quad Pro MBF4U	Quad Pro AddOn MBF4U
Recommended screen size:	32"-65"	32"-65"	32"-65"	32"-65"
VESA® & non-VESA fixings:	VESA400 ,40cm	VESA400 ,40cm	VESA400 ,40cm	VESA400 ,40cm
EAN:	7350073737697	7350073737703	7350073737710	7350073737727
Max load:	30kg Per screen	30kg Per screen	30kg Per screen	30kg Per screen
Bracket type:	Tilt	Tilt	Tilt	Tilt
Landscape/portrait:	Yes	Landscape	Yes	Landscape
Pole height (cm):	200cm	200cm	200cm	200cm
Colour (VESA arms):	Black	Black	Black	Black
Optional colour:	Chrome, White, Brass, Tailored	Chrome, White, Brass, Tailored	Chrome, White, Brass, Tailored	Chrome, White, Brass, Tailored
Warranty:	5 years	5 years	5 years	5 years
Accessories:	Cover plate	Cover plate	Cover plate	Cover plate

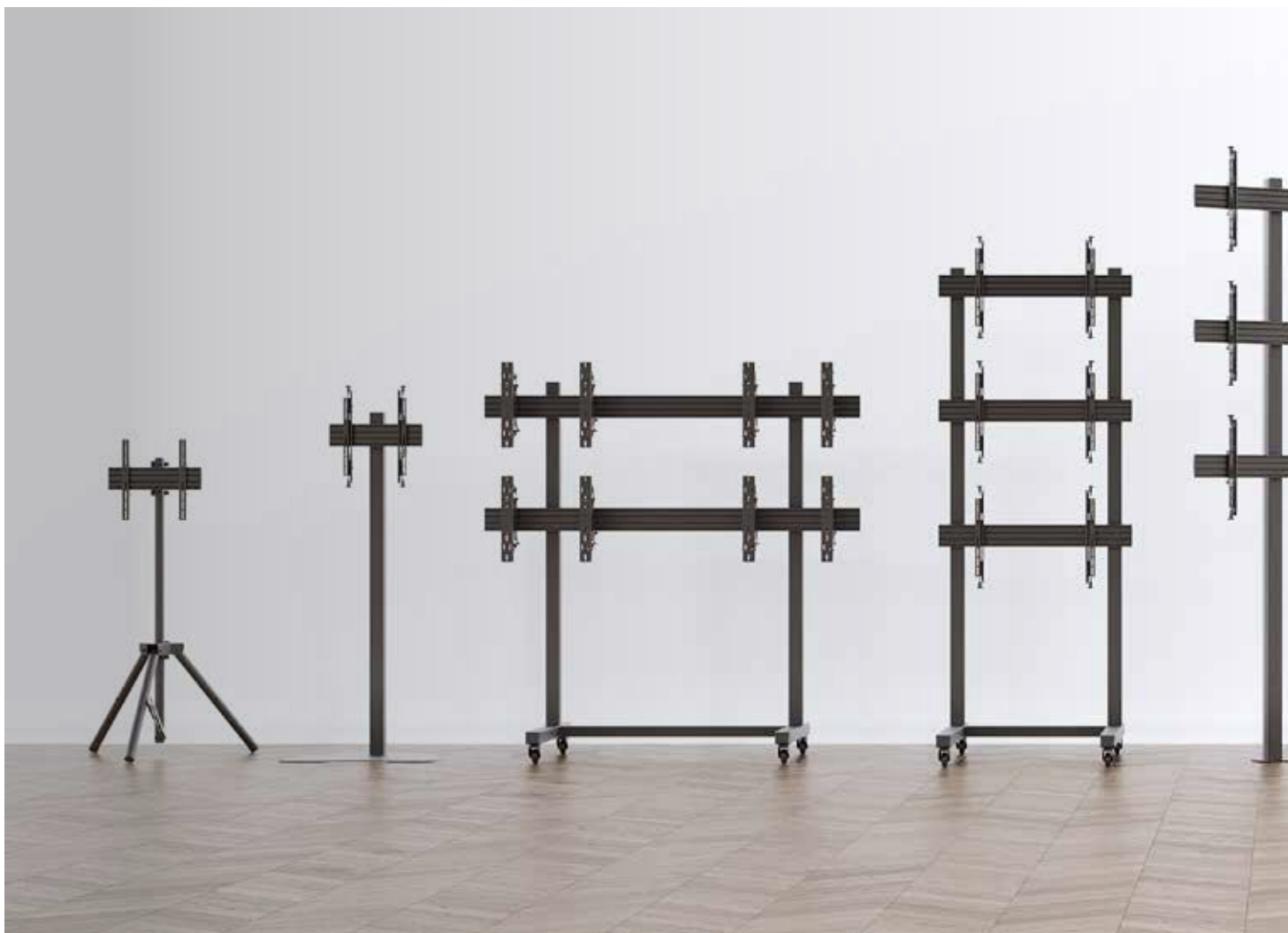

Pro Series Floorstand line up

With the unique modular set up the Pro Series range of floorstand´s designed to support one, two, three or more screens mounted in most ways imaginable in either landscape or portrait. Simple to install, clean and attractive design, yet

very robust and functional the Dual Pole series is ideal for a wide variety of applications and settings.

Designed to provide the ideal display viewing placement and match the décor of any

environment. Ideal for public areas like stores, training rooms, lobbies, classrooms, auditoriums, or exhibition halls.

As with all Pro series products a full line-up of accessories offering tailor possibilities

functionality to meet your specific requirements. Internal cable management hides the AV cabling, showing a clean look.

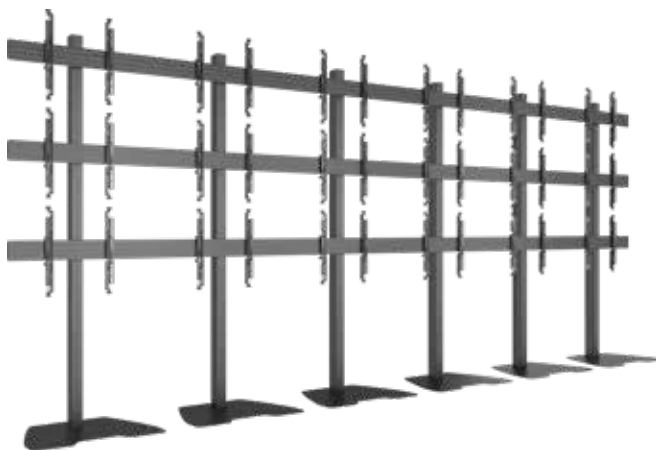

Model:	MBFC3UX3 Micro Adjustable
Recommended screen size:	43"-65"
VESA & Non-VESA Fixings:	VESA 400, 40cm
EAN:	7350105216824
Max load:	30kg (Per screen)
Bracket type:	Micro Adjustable
Landscape / portrait:	Portrait
Pillar length:	300 cm
Colour (VESA arms):	Black
Colour (Horizontal rail):	Black (Silver optional)
Colour (Pillar):	Black
Warranty:	5 years

MBFM2x1U 180 Micro Adjustable



MBFM3x1U 180 Micro Adjustable



MBFM4x2U 270 Micro Adjustable

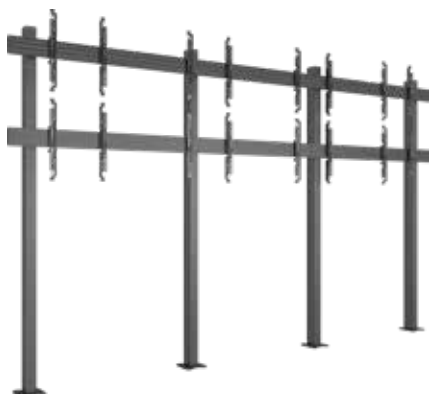

MBFC3U 300 Micro Adjustable



	Model: MBFM2x1U 180 Micro Adjustable	Model: MBFM3x1U 180 Micro Adjustable	Model: MBFM4x2U 270 Micro Adjustable	Model: MBFC3U 300 Micro Adjustable
Recommended screen size:	43"-65"	43"-65"	43"-65"	43"-65"
VESA & Non-VESA Fixings:	VESA 400, 40cm	VESA 400, 40cm	VESA 400, 40cm	VESA 400, 40cm
EAN:	735010521 3397	735010521 3427	735010521 3618	735010521 2567
Max load:	30kg (Per screen)	30kg (Per screen)	30kg (Per screen)	30kg (Per screen)
Bracket type:	Micro Adjustable	Micro Adjustable	Micro Adjustable	Micro Adjustable
Landscape / portrait:	Portrait	Yes	Yes	Yes
Pillar length:	180 cm	180 cm	270 cm	300 cm
Colour (VESA arms):	Black	Black	Black	Black
Colour (Horizontal rail):	Black (Silver optional)	Black (Silver optional)	Black (Silver optional)	Black (Silver optional)
Colour (Pillar):	Black	Black	Black	Black
Warranty:	5 years	5 years	5 years	5 years

MBFSC1U 180 Micro Adjustable



MBFSC2U 180 Micro Adjustable



MBFSC1U 270 Micro Adjustable

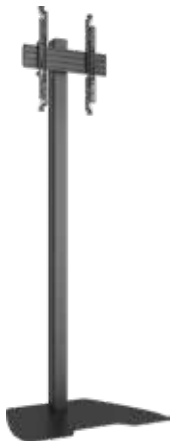

MBFSC2U 270 Micro Adjustable



MBFSC3U 270 Micro Adjustable

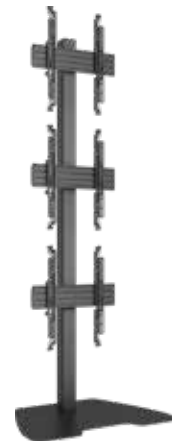

	Model: MBFSC1U 180 Micro Adjustable	Model: MBFSC2U 180 Micro Adjustable	Model: MBFSC1U 270 Micro Adjustable	Model: MBFSC2U 270 Micro Adjustable	Model: MBFSC3U 270 Micro Adjustable
Recommended screen size:	43"-65"	43"-65"	43"-65"	43"-65"	43"-65"
VESA & Non-VESA Fixings:	VESA 400, 40cm	VESA 400, 40cm	VESA 400, 40cm	VESA 400, 40cm	VESA 400, 40cm
EAN:	735010521 4103	735002273 6764	735010521 4110	735010521 5612	735002273 6757
Max load:	30kg	30kg (Per screen)	30kg (Per screen)	30kg (Per screen)	30kg (Per screen)
Bracket type:	Micro Adjustable	Micro Adjustable	Micro Adjustable	Micro Adjustable	Micro Adjustable
Landscape / portrait:	Yes	Landscape	Yes	Landscape	Landscape
Pillar length:	180cm	180cm	270cm	270cm	270cm
Colour (VESA arms):	Black	Black	Black	Black	Black
Colour (Horizontal rail):	Black (Silver optional)	Black (Silver optional)	Black (Silver optional)	Black (Silver optional)	Black (Silver optional)
Colour (Poles & ceiling mount):	Black	Black	Black	Black	Black
Warranty:	5 years	5 years	5 years	5 years	5 years

Video Wall Stand 1X2



Video Wall Stand 1X3



MBFSC1U 300



MBF2x1U



	Video Wall Stand 1X2	Video Wall Stand 1X3	MBFSC1U 300	MBF2x1U
Model:	Video Wall Stand 1X2	Video Wall Stand 1X3	MBFSC1U 300	MBF2x1U
Recommended screen size:	46"-75"	46"-75"	43" - 110 "	43"-65"
VESA & Non-VESA Fixings:	1000x400mm	1000x400mm	1600x600mm	VESA 400, 40cm
EAN:	735010521 6961	735010521 6954	735010521 6749	735010521 3496
Max load:	50kg (Per screen)	50kg (Per screen)	80kg	125kg
Bracket type:	Micro Adjustable	Micro Adjustable	Fixed (Tilt optional)	Micro Adjustable
Landscape / portrait:	Portrait	Yes	Yes	Yes
Pillar length:	180 cm	270 cm	270 cm	180 cm
Colour (VESA arms):	Black	Black	Black	Black
Colour (Horizontal rail):	Black (Silver optional)	Black (Silver optional)	Black (Silver optional)	Black (Silver optional)
Colour (Pillar):	Black	Black	Black	Black
Warranty:	5 years	5 years	5 years	5 years

MBF2x3U



MBF3x1U



MBF3x2U

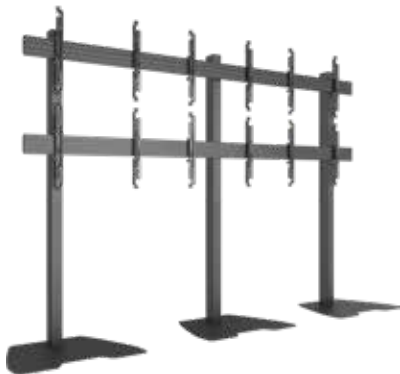

MBFC3UX3



	MBF2x3U	MBF3x1U	MBF3x2U	MBFC3UX3
Model:	MBF2x3U	MBF3x1U	MBF3x2U	MBFC3UX3
Recommended screen size:	43"-65"	43"-65"	43"-65"	43"-65"
VESA & Non-VESA Fixings:	VESA 400, 40cm	VESA 400, 40cm	VESA 400, 40cm	VESA 400, 40cm
EAN:	735010521 3502	735010521 3519	735010521 3526	735010521 3533
Max load:	30kg (Per screen)	30kg (Per screen)	30kg (Per screen)	30kg (Per screen)
Bracket type:	Micro Adjustable	Micro Adjustable	Micro Adjustable	Micro Adjustable
Landscape / portrait:	Portrait	Yes	Yes	Yes
Pillar length:	300 cm	180 cm	180 cm	300 cm
Colour (VESA arms):	Black	Black	Black	Black
Colour (Horizontal rail):	Black (Silver optional)	Black (Silver optional)	Black (Silver optional)	Black (Silver optional)
Colour (Pillar):	Black	Black	Black	Black
Warranty:	5 years	5 years	5 years	5 years

Multibrackets Pro Series™ - Video Wall Mounting System

Freestanding video walls

Construct video walls in prominent locations

Pro Series Video Wall Mounting Systems handles both landscape or portrait arrangements of displays to fit any application. There are multiple screen array configurations possible, and its flexible just build and add after time or as your needs change. Most displays between 32" to

65" can be used. Set the height based on the 180/270/300cm high columns made out of highest-grade aluminum. Its easy to change height and it is possible to set or reset height to provide a great viewing angle for both a sitting and a standing audiences. A movable wheelbase

or floor based directly on the ground makes these video walls optimal for presentations, trade shows, stores or office entrances. This is a perfect solution for customers who need a mobile or stationary presentation system for VTC, digital signage applications, and more. With

the right combination of durability and serviceability, these videowalls provide a standardized and cost-efficient solution designed to fit most applications or environments.

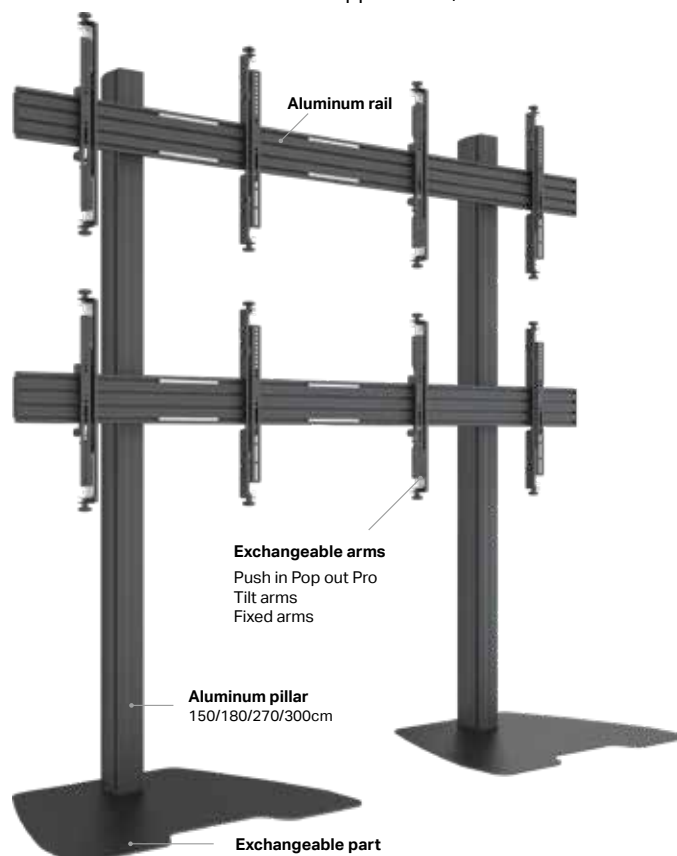

Flexible & robust

Add or delete displays anytime or per occasion. M Pro Series freestanding videowalls allows videowall to be moved into any application. The high quality construction makes the line perfect for rental or short term pop up installations. Create a permanent bolt down solution when a wall isn't available. Possibility to align displays with independent height, depth and lateral shift adjustments.

Highlights:

- Floorbase, floormount or wheelbase
- Permanent bolt-down possible
- Integrated cable management
- Change design after new needs occur

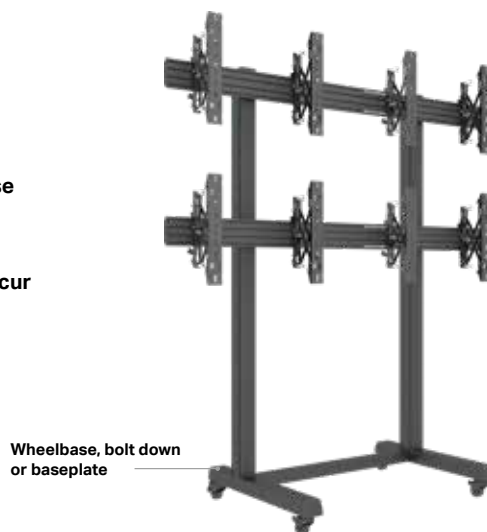

M Pro Series Video Wall Stand



2x2



3x2



4x2



3x3

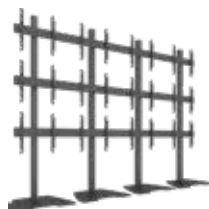

4x3

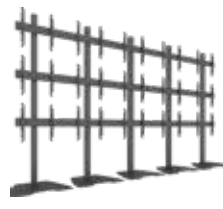

5x3

M Pro Series Floormount Column



2x2

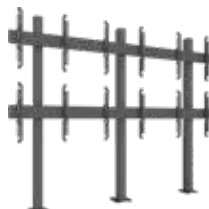

3x2

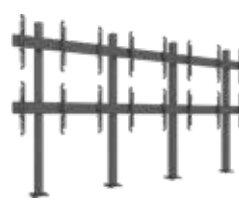

4x2

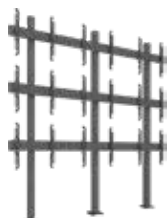

3x3

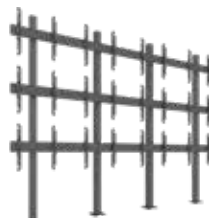

4x3

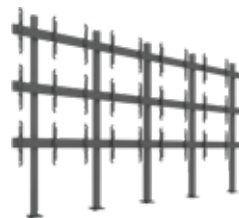

5x3

M Pro Series Video Wall



2x2



3x2

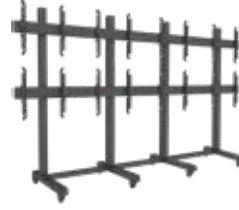

4x2

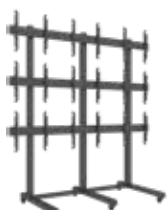

3x3

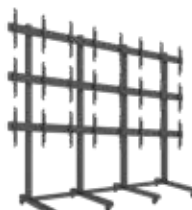

4x3

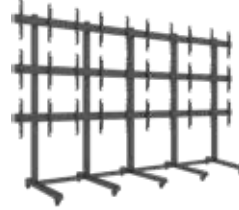

5x3



Pro Series Curved

Made for 

With the unique modular set up the Pro Series range of floor-stand´s designed to support one, two, three or more screens mounted in most ways imaginable in either landscape or portrait.

Simple to install, clean and attractive design, yet very robust and functional the Dual Pole series is ideal for a wide variety of applications and settings. Designed to provide the ideal display viewing placement and

match the décor of any environment. Ideal for public areas like stores, training rooms, lobbies, classrooms, auditoriums, or exhibition halls.

As with all Pro series products a full line-up of accessories offering tailor possibilities functionality to meet your specific requirements. Internal cable management hides the AV cabling, showing a clean look.

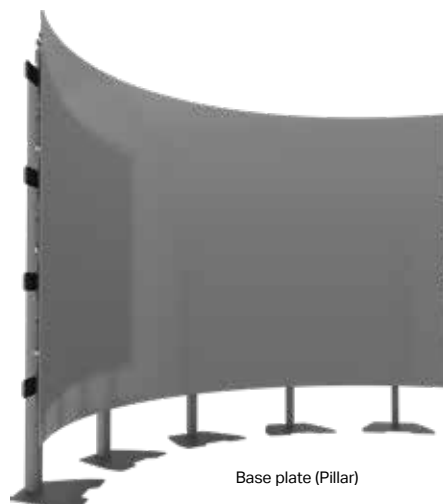

Base plate (Pillar)

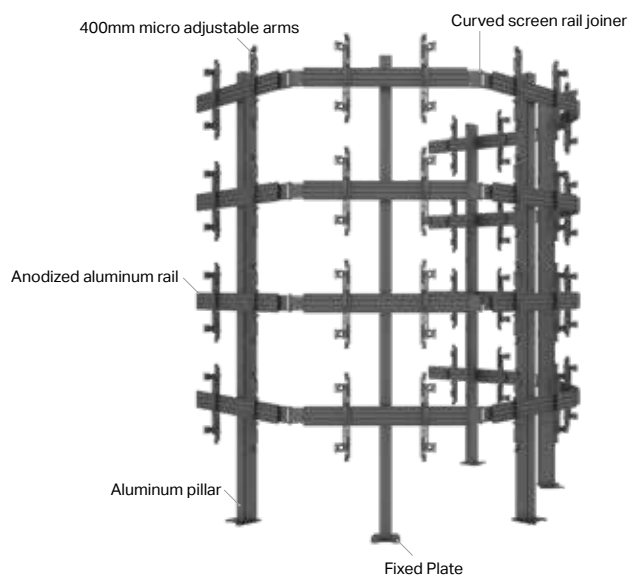

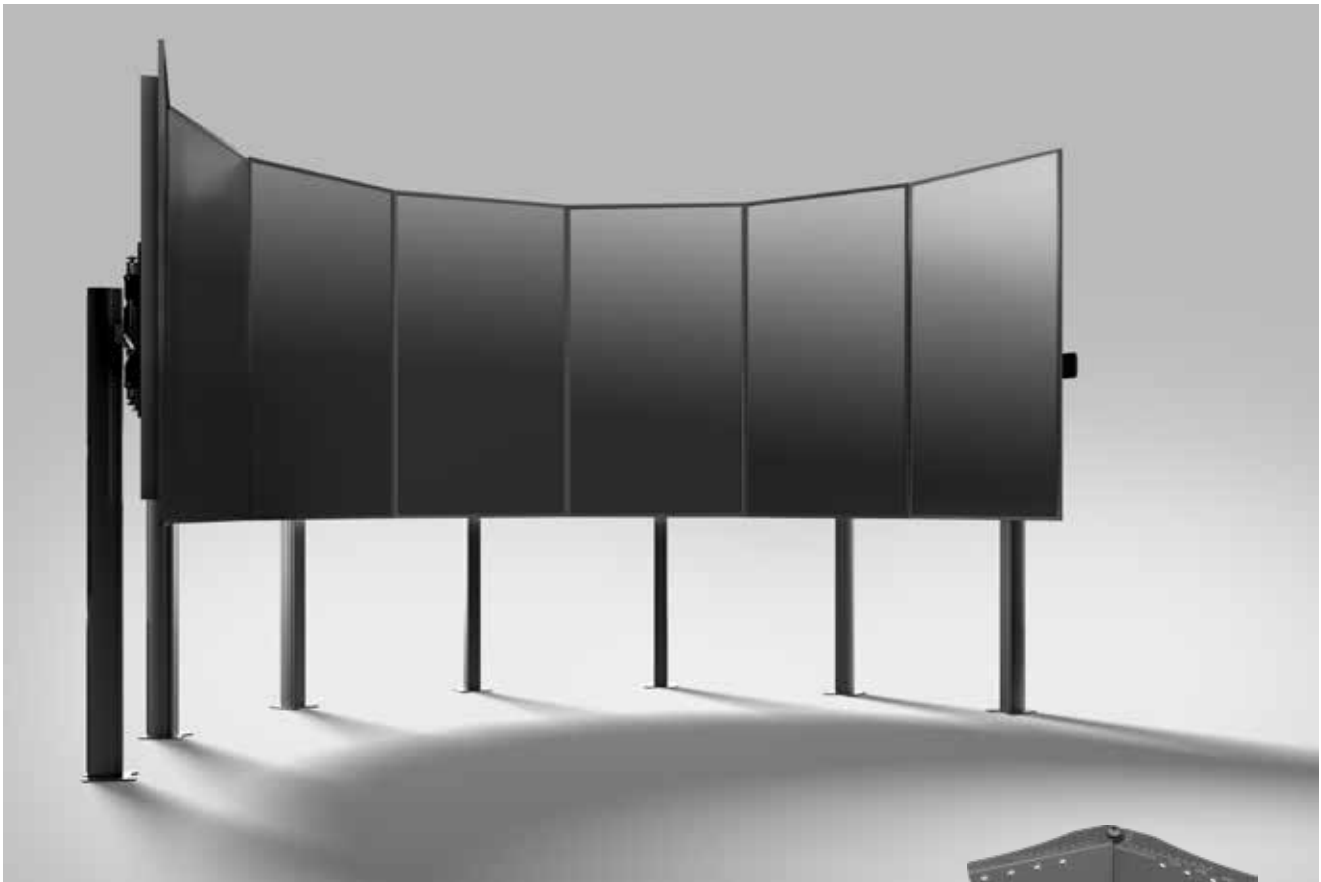

This Pro Series Part creates curved magic for videowalls.

Pro Series Curved solutions

Create tailored installations with Pro Series

Create tailored installations with the possibility to mix both computer displays with digital signage displays. The M Pro Series Pole line of brackets offers a variety of flexible solutions with tilt and turn

possibilities. Start utilizing our clean and simple Scandinavian designed brackets with durable construction and easy installation. A complete set of hardware is always included.

Curved screen rail joiner

EAN: 7350073736348

Turn: -45° ~ +45°

Distance adj.: 0 ~ 200 mm

Highlights:

- Works with most screens the market has to offer
- Fast & accurate assembly & installation
- Simple access & quick rear service

Popular models:



Ceiling mount



Floor to ceiling

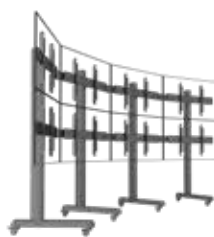

Wheelbase



Floor mounted

MBFC1U 150cm

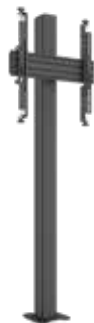

MBFC1U 180cm



MBFC1U 270cm



MBFMC3x1U



	MBFC1U 150cm	MBFC1U 180cm	MBFC1U 270cm	MBFMC3x1U
Model name:	MBFC1U 150cm	MBFC1U 180cm	MBFC1U 270cm	MBFMC3x1U
Recommended screen size:	43" - 50"	43" - 65"	43" - 65"	43" - 65"
VESA® & non-VESA fixings:	VESA400 ,40cm	VESA400 ,40cm	VESA400 ,40cm	VESA400 ,40cm
EAN:	7350105210280	7350105210297	7350105210303	7350105214622
Max load:	30kg (Per screen)	30kg (Per screen)	30kg (Per screen)	30kg (Per screen)
Bracket type:	Micro Adjustable	Micro Adjustable	Micro Adjustable	Micro Adjustable
Landscape/portrait:	Yes	Yes	Yes	Yes
Pillar length:	150 cm	180 cm	270 cm	180/270cm
Colour (VESA arms):	Black	Black	Black	Black
Colour (horizontal rail):	Black (Silver optional)	Black (Silver optional)	Black (Silver optional)	Black (Silver optional)
Colour (pillar):	Black	Black	Black	Black
Warranty:	5 years	5 years	5 years	5 years

MBFC2U 180cm



MBFC2U 270cm



MBFC3U 270cm



MBFMC3x3U

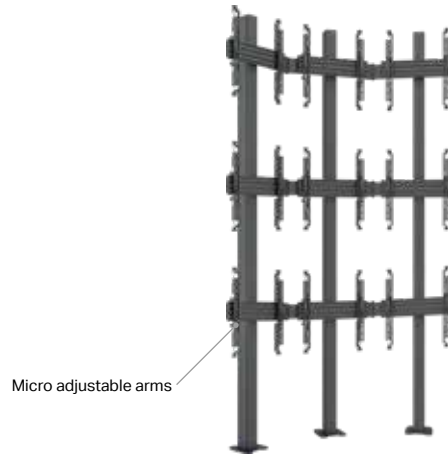

	MBC2U 180cm	MBC2U 270cm	MBC3U 270cm	MBFMC3x3U
Model name:	MBC2U 180cm	MBC2U 270cm	MBC3U 270cm	MBFMC3x3U
Recommended screen size:	43" - 65"	43" - 65"	43" - 65"	43" - 65"
VESA® & non-VESA fixings:	VESA400 ,40cm	VESA400 ,40cm	VESA400 ,40cm	VESA400 ,40cm
EAN:	7350105210310	7350105210327	7350105210334	7350105214646
Max load:	30kg (Per screen)	30kg (Per screen)	30kg (Per screen)	30kg (Per screen)
Bracket type:	Micro Adjustable	Micro Adjustable	Micro Adjustable	Micro Adjustable
Landscape/portrait:	Landscape	Landscape	Landscape	Landscape
Pillar length:	Landscape / Portrait	80 cm up to 150 cm	80 cm up to 150 cm	80 cm up to 150 cm
Colour (VESA arms):	Black	Black	Black	Black
Colour (horizontal rail):	Black (Silver optional)	Black (Silver optional)	Black (Silver optional)	Black (Silver optional)
Colour (pillar):	Black	Black	Black	Black
Warranty:	5 years	5 years	5 years	5 years

MBFMC3x1U



MBFMC3x2U



MBFMC3x3U



MBFMC6x3U



	MBFMC3x1U	MBFMC3x2U	MBFMC3x3U	MBFMC6x3U
Model name:	MBFMC3x1U	MBFMC3x2U	MBFMC3x3U	MBFMC6x3U
Recommended screen size:	43" - 65"	43" - 65"	43" - 65"	43" - 65"
VESA® & non-VESA fixings:	VESA400 ,40cm	VESA400 ,40cm	VESA400 ,40cm	VESA400 ,40cm
EAN:	7350105214622	7350105214639	7350105214646	7350105214653
Max load:	30kg (Per screen)	30kg (Per screen)	30kg (Per screen)	30kg (Per screen)
Bracket type:	Micro Adjustable	Micro Adjustable	Micro Adjustable	Micro Adjustable
Landscape/portrait:	Landscape	Landscape	Landscape	Landscape
Pillar length:	80 cm up to 150 cm	80 cm up to 150 cm	80 cm up to 150 cm	80 cm up to 150 cm
Colour (VESA arms):	Black	Black	Black	Black
Colour (horizontal rail):	Black (Silver optional)	Black (Silver optional)	Black (Silver optional)	Black (Silver optional)
Colour (pillar):	Black	Black	Black	Black
Warranty:	5 years	5 years	5 years	5 years



No measuring, no guessing, no mistakes

Public videowall mounts

Video walls should be easy to configure, quick to install, and easy to maintain. Introducing the Multibrackets range of full service Video Wall Mounts. Create any configuration imaginable, but leave the tedious calculations to the custom

wall plate spacers. Just install the first mount. Then use the custom wall plate spacers to perfectly place each additional mount on the wall. It couldn't be simpler.

Video Wall Mount Push X Small



Video Wall Mount Push X Small 200



Video Wall Mount Push Slim



Video Wall Mount Push HD



Model name:	Video Wall Mount Push X Small	Video Wall Mount Push X Small 200	Video Wall Mount Push Slim	Video Wall Mount Push HD
For screen size:	13" - 32"	13" - 43"	40" - 55"	43" - 70"
VESA:	50x50, 75x75, 100x100	50x50, 75x75, 100x100, 200x200	VESA 600x400/400x600	200x200, 300x200, 300x300, 400x200, 400x400, 400x600, 600x400
EAN:	735010521 0952	735010521 5636	735007373 9967	735007373 0568
Colour:	Black	Black	Black	Black
Size in mm:	251 x 298 x 74 mm	251 x 298 x 74 mm	534 x 542 mm	760 x 460mm
Max load:	18 kg	18 kg	35kg	50 kg
Weight:	2.6 kg	3.5 kg	7.5 kg	12 kg
Warranty:	2 years	2 years	2 years	2 years



Public video wall Mount Push HD

The M Public Video Wall Mount Push HD might just be one of the markets most innovative and easy to install video wall mounts available. With numerous post installation possibili-

ties and a tailored pantograph alignment system this might be the most easy to use, yet most powerful video wall mount system you have ever seen.

M Public Video Wall Mount Glide HD



Adjustment:
Numerous post installation possibilities

M Public Video Wall Mount Push HD Max 90kg



M Public Video Wall Mount Push HD Max 90kg (with extenders)



Up to VESA 900

Powerful VESA Extenderkits available
From 600mm to 1200mm

M Public Video Wall Mount Push SD 150Kg Max



Model name:	M Public Video Wall Mount Glide HD	Video Wall Mount Push HD Max 90kg	M Public Video Wall Mount Push SD 150Kg Max
For screen size:	40" - 70"	50" - 95"	50" - 110"
EAN:	735007373 5792	735007373 1749	735007373 4818
VESA:	200x200, 300x200, 300x300, 400x200, 400x400	200x200, 300x300, 400x200, 400x400, 600x400, 400x600, 800x400, 400x800, 900x400, 400x900	200x200, 300x200, 300x300, 400x200, 400x400
By adapterkit:	600x400 and 800x400		Up to 900x600
Size in mm:	760 x 460mm	760 x 460mm	760x460mm
Max load:	35 kg	90 kg	150 kg
Weight:	12 kg	14 kg	14 kg
Warranty:	2 years	2 years	2 years

Elegant and minimal



Pro Series Wire combinations

Make a strong design statement with these spectacular wire based mounts. Now you can hang your screen in wires using the Pro Series wire based system. All parts utilized is the standard Pro Series items but

you also add the wires to hang the screen in position. Use single screen or back to back installations. Treat your clients stores to a visual make over with these elegant and minimal wire based combinations.

Designed to combine style with functionality, these displays can easily set up in most stores with a major wow factor.

- Up to 600cm height
- Single or Back to back

Wire 3000



Wire 6000

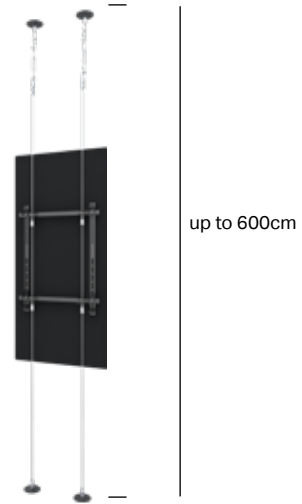

Wire 3000 B2B



Wire 6000 B2B

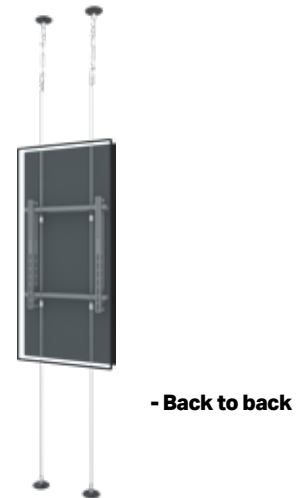

- Back to back

Model name:	Wire 3000	Wire 6000	Wire 3000 B2B	Wire 6000 B2B
Recommended screen size:	40"-65"	40"-65"	40"-65"	40"-65"
VESA® & non-VESA fixings:	VESA600 ,60cm	VESA600 ,60cm	VESA600 ,60cm	VESA600 ,60cm
EAN:	7350073736959	7350073736966	7350073737055	7350073737062
Max load:	30kg	30kg	30kg (Per screen)	30kg (Per screen)
Bracket type:	Fixed	Fixed	Fixed	Fixed
Landscape/portrait:	Portrait	Portrait	Portrait	Portrait
Wire length:	300cm	600cm	300cm	600cm
Colour (VESA arms):	Black	Black	Black	Black
Colour (wire):	Chrome	Chrome	Chrome	Chrome
Warranty:	5 years	5 years	5 years	5 years



Works well with:



New!
Pro Series
Floorstands
Monitors

Multibrackets Pro Series M Floorstand mount for LED display, steel, 1m height, 1 screens, VESA 75x75, 100x100, screen size: 7"-30". The new professional Pro Series A/V line from Multibrackets was designed with the installer in mind. Modular, easy to

configure, quick to install, and simple to maintain. Working closely with installers we created a range with close to unlimited flexibility. This model the M Floorstand Pro is no exception. The product provides the versatility and flexibility demanded by installers.



M Pro Series Single Pole Floorbase



M Pro Series Single Pole Floorbase B2B



Kiosk Black 15"-32"

Kiosk White 15"-32"

M Pro Series Kiosk Black 15"-32"

M Pro Series - Kiosk 15-32" 200/300/400

M Kiosk Black with Lockable Tablet Mount 7"-14.6" 200/300/400



Model name:	M Pro Series Single Pole Floorbase	M Pro Series Single Pole Floorbase B2B	M Pro Series Kiosk Black 15"-32"	M Pro Series - Kiosk 15-32" 200/300/400	M Kiosk Black with Lockable Tablet Mount 7"-14.6"
Recommended screen size:	10"-30"	10"-30"	15"-32"	15"-32"	15"-32"
VESA® & non-VESA fixings:	75x75, 100x100cm	75x75, 100x100cm	75x75, 100x100, 200x100	200x200, 300x300, 400x400	Tablet mount 7"-14.6"
EAN:	735010521 0549	735010521 3069	735010521 5179	735010521 5490/5483	735010521 7128
Max load:	10 kg	10 kg/screen	20 kg	20 kg	20 kg
Bracket type:	Tilt	Tilt	Fixed	Fixed	Fixed
Floormount:	Yes	Yes	Yes	Yes	-
Floorstand:	Yes (floorbase included)	Yes (floorbase included)	Yes (floorbase included)	Yes (floorbase included)	-
Landscape/portrait:	Yes	Yes	Yes	Yes	Yes
Pole height (cm):	1000mm	1000mm	450x300x1045mm	450x300x1045mm	450x300x1045mm
Colour:	Black	Black	Black	White / Black	Black
Warranty:	5 years	5 years	5 years	5 years	5 years

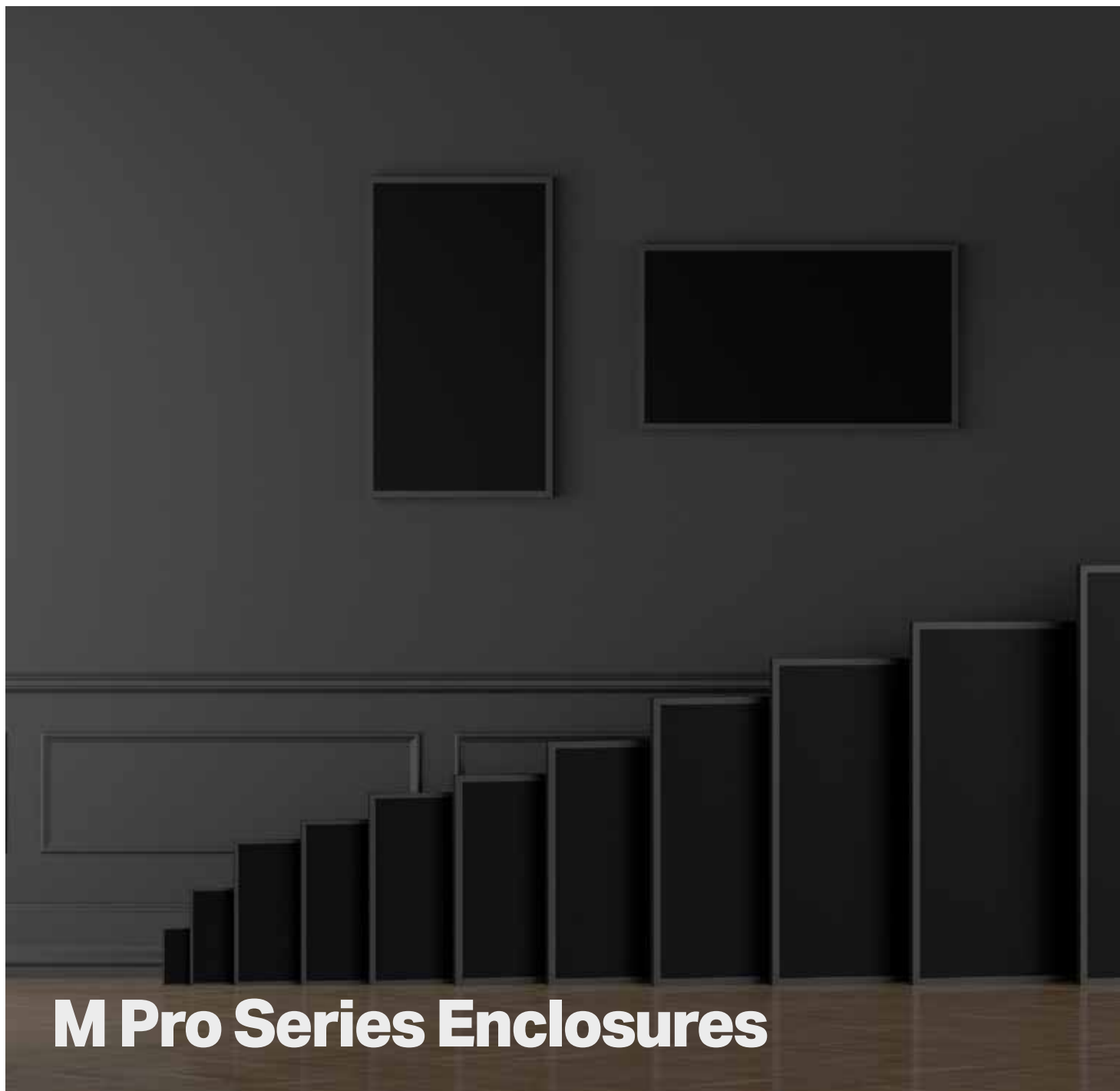

M Pro Series Enclosures

A selection of our enclosures and totems

Create a minimalistic look and choose to mount in both Portrait or Landscape position. Multibrackets® enclosures are one of the most versatile to date. Choose between screen sizes and colors. These enclosures include after adjustment possibilities and can be used for most brands of signage displays on the market. With a

smart thermal management, this solution can fit more brands as well as creating thermal management second to none. These clean styled black Pro Series Enclosures brings new flexibility to the digital signage enclosure market while maintaining a sleek aesthetic to complement a variety of environments. A depth

adjustable exterior frame allows for a variety of displays to be used. Reversible hinges help avoid installation and service obstructions, and the exclusive design. Unparalleled service and maintenance access. Integrated passive cooling vents with active thermal management options. Tamperproof security

hardware protects technology investments. Blends in perfectly in most environments. Added its ingenious design makes many smart options available right away or after time, mounting solutions with wire function, floor to ceiling or floor stand and ceiling mounting is available.

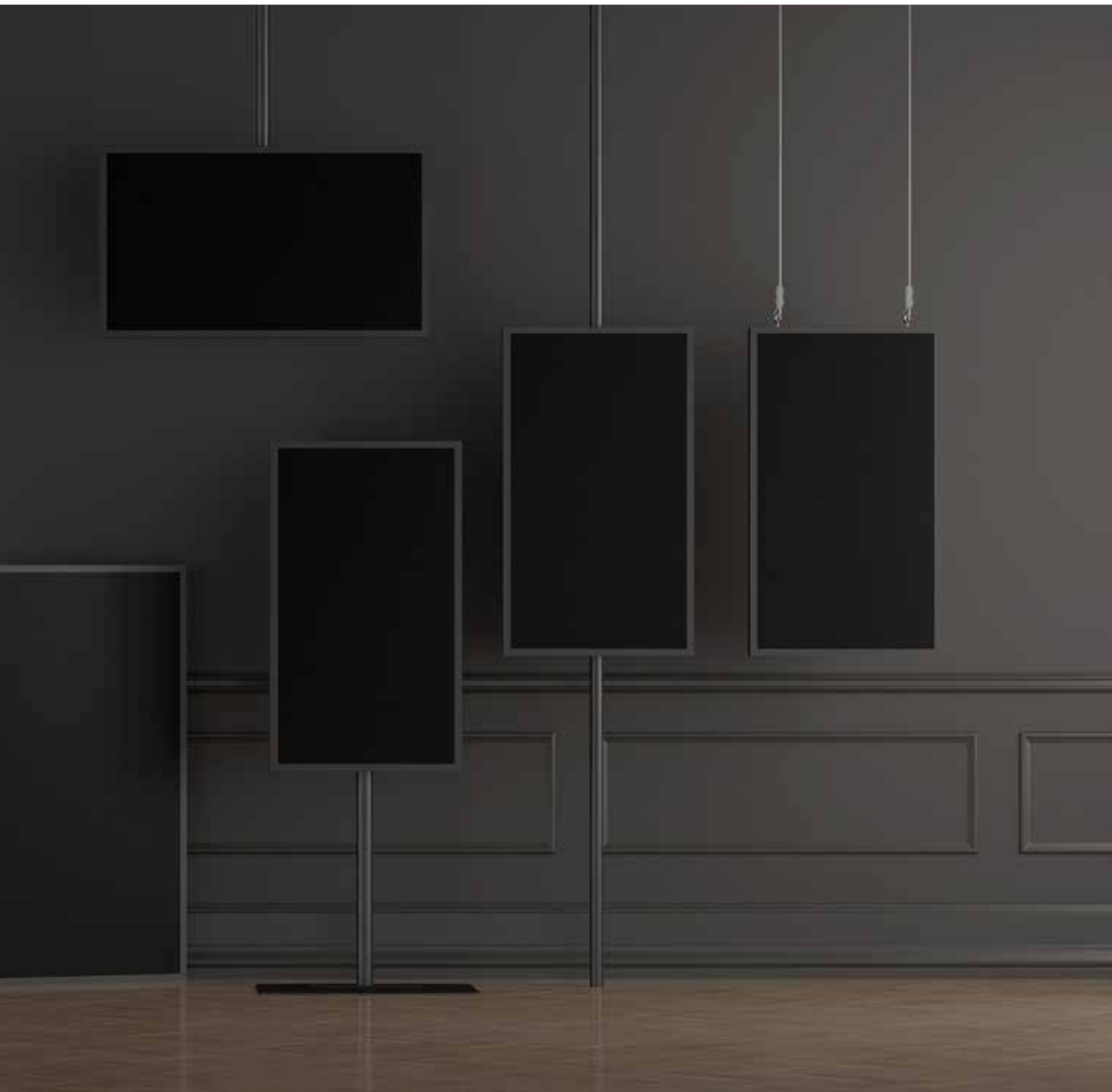

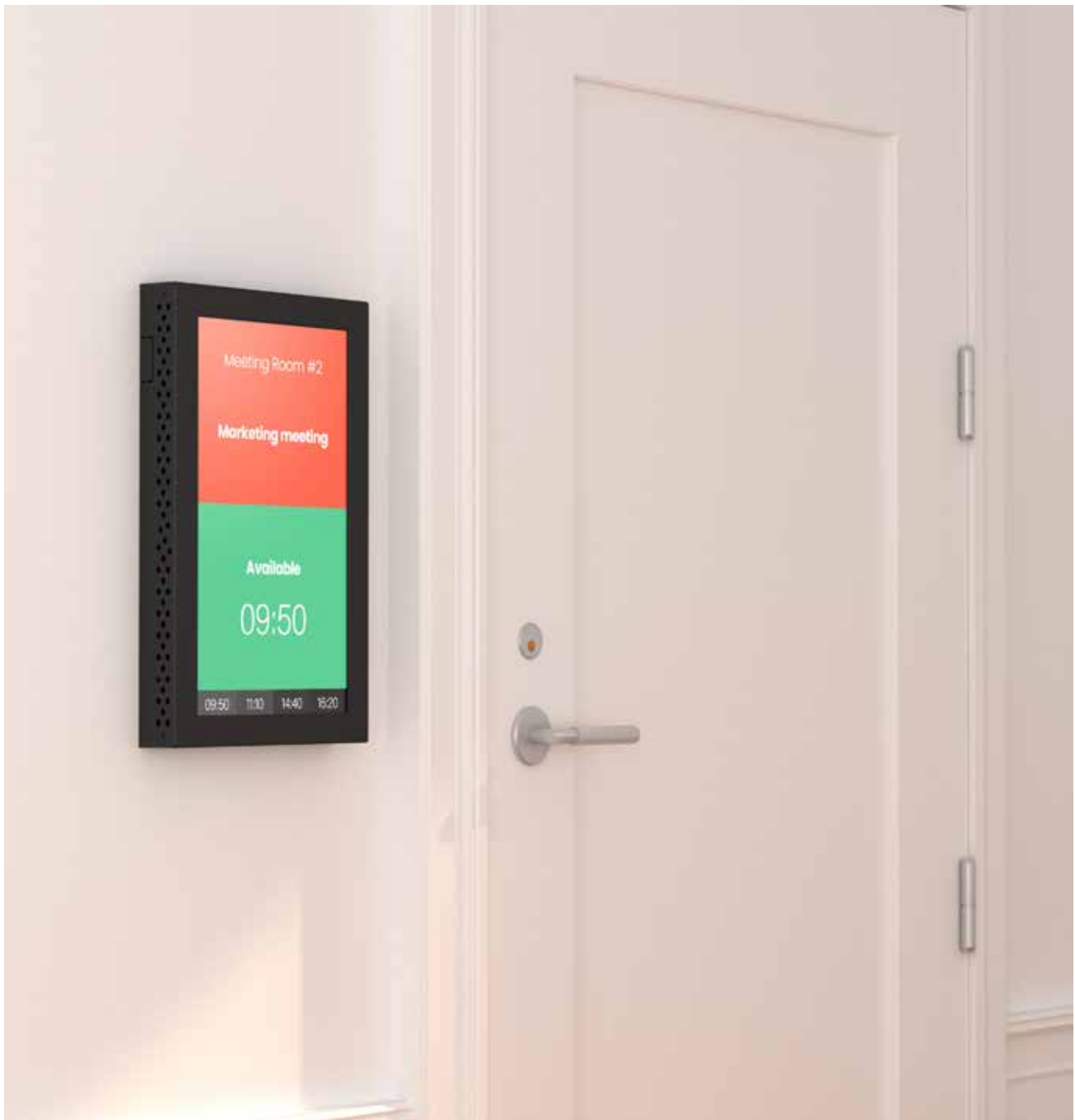

Pro Series **10"-24" enclosures**

**Simplify small size signage installations
with a thin and easy-to-install enclosure.**

Experience the elegance of Multibrackets new indoor enclosures designed to support the latest LED displays. With an ingenious design these enclosures have a wide range of applications making them easy to install and maintain.

M Pro Series Enclosure ELO 10"



elo

M Pro Series Enclosure Cisco Touch 10" White



CISCO

M Pro Series Enclosure QB13R & QB13R-T

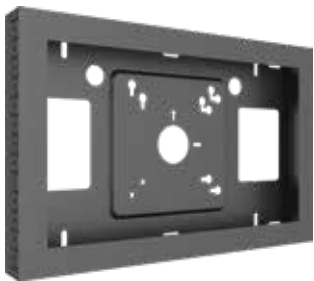

- Black
- White

SAMSUNG

M Pro Series Enclosure LG22SM3G



- Black
- White

LG

M Pro Series Enclosure QB24R & QB24R-T



- Black
- White

SAMSUNG

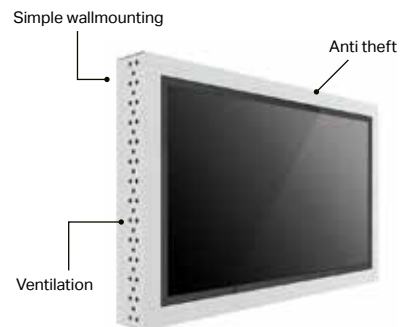

	M Pro Series Enclosure ELO 10"	M Pro Series Enclosure Cisco Touch 10"	M Pro Series Enclosure QB13R & QB13R-T	M Pro Series Enclosure LG22SM3G	M Pro Series Enclosure QB24R & QB24R-T
EAN:	7350073739400	7350105210488	Black: 7350073738519 White: 7350073738908	Black: 7350105211041 White: 7350105211058	Black: 7350105211386 White: 7350105211393
VESA standard:	75x75 mm	100x100mm	100x100mm	100x100 mm	100x100 mm
Installation:	ELO 10" screen	Cisco CTS-CTRL-DV10	Samsung QB13R & QB13R-T	LG 22" 22SM3G	Samsung QB24R or QB24R-T
Weight:	2.0 kg	0.9kg	2kg	3,2 kg	3,5 kg
Max Load:	5 kg	5 kg	10 kg	10 kg	10 kg
Measurements:	320x242x52 mm	30.1x23.2x5cm	39.2x26.2x5cm	590 x 380 x 65 mm	615 x 385 x 48 mm
Material:	Steel	Steel	Steel	Steel	Steel
Surface Finish:	Powder coating	Powder coating	Powder coating	Powder coating	Powder coating
Colour:	Black	White	Black / White	Black / White	Black / White
Warranty:	5 years	5 years	5 years	5 years	5 years



Enclosure 32" Ceiling Small Black



Enclosure 32" Ceiling Small White



Enclosure 37" Ceiling Small Black



Enclosure 37" Ceiling Small White



	Model: Enclosure 32" Ceiling Small Black	Enclosure 32" Ceiling Small White	Enclosure 37" Ceiling Small Black	Enclosure 37" Ceiling Small White
Recommended screen size:	32"	32"	37"	37"
VESA & Non-VESA Fixings:	200x200, 300x300mm	200x200, 300x300mm	200x200, 300x300mm	200x200, 300x300mm
EAN:	735010521 5018	735010521 5025	735010521 5209	735010521 5216
Max load:	30kg	30kg	30kg	30kg
Landscape / portrait:	Yes	Yes	Yes	Yes
Pole length:	80cm up to 150cm	80cm up to 150cm	80cm up to 150cm	80cm up to 150cm
Colour:	Black	White	Black	White
Accessories:	Yes (optional)	Yes (optional)	Yes (optional)	Yes (optional)

Enclosure 43" Ceiling Small Black



Enclosure 43" Ceiling Small White



Enclosure 50" Ceiling Medium Black



Enclosure 50" Ceiling Medium White



Model:	Enclosure 43" Ceiling Small Black	Enclosure 43" Ceiling Small White	Enclosure 50" Ceiling Medium Black	Enclosure 50" Ceiling Medium White
Recommended screen size:	43"	43"	50"	50"
VESA & Non-VESA Fixings:	200x200, 300x300mm	200x200, 300x300mm	200x200, 300x300mm	200x200, 300x300mm
EAN:	735010521 5032	735010521 5049	735010521 3854	735010521 3861
Max load:	30kg	30kg	30kg	30kg
Landscape / portrait:	Yes	Yes	Yes	Yes
Pole length:	80cm up to 150cm	80cm up to 150cm	80cm up to 150cm	80cm up to 150cm
Colour:	Black	White	Black	White
Accessories:	Yes (optional)	Yes (optional)	Yes (optional)	Yes (optional)

Enclosure 50" Ceiling Medium B2B Black



Enclosure Ceiling Mount B2B 55" Medium Black



Enclosure Ceiling Mount B2B 55" Medium White

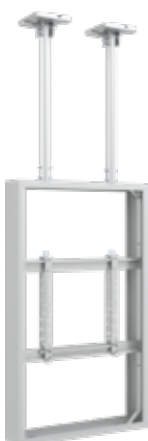

Enclosure 75" Ceiling Large



Model:	Enclosure 50" Ceilingmount Medium B2B Black	Enclosure Ceiling Mount B2B 55" Medium Black	Enclosure Ceiling Mount B2B 55" Medium White	Enclosure 75" Ceiling Large Black/White
Recommended screen size:	50"	55"	55"	75"
VESA & Non-VESA Fixings:	200x200, 300x300, 400x400, 600x400mm	200x200, 300x300, 400x400, 600x400mm	200x200, 300x300, 400x400, 600x400mm	200x200, 300x300, 400x400, 600x400mm
EAN:	735010521 3939	735010521 6825	735010521 6832	735010521 5810/5827
Max load:	30kg (Per screen)	30kg (Per screen)	30kg (Per screen)	50kg
Landscape / portrait:	Yes	Yes	Yes	Yes
Pole length:	80cm up to 150cm	80cm up to 150cm	80cm up to 150cm	80cm up to 150cm
Colour:	Black	Black	White	Black
Accessories:	Yes (optional)	Yes (optional)	Yes (optional)	Yes (optional)



Enclosure 50" Floor to Ceiling Medium Black



Enclosure 50" Floor to Ceiling Medium White



Enclosure Floor to Ceiling Mount B2B 55" Medium Black



Enclosure Floor to Ceiling Mount B2B 55" Medium White



Model:	Enclosure 50" Floor to Ceiling Medium Black	Enclosure 50" Floor to Ceiling Medium White	Enclosure Floor to Ceiling Mount B2B 55" Medium Black	Enclosure Floor to Ceiling Mount B2B 55" Medium White
Recommended screen size:	50"	50"	55"	55"
VESA & Non-VESA Fixings:	200x200, 300x300, 400x400, 600x400mm	200x200, 300x300, 400x400, 600x400mm	200x200, 300x300, 400x400, 600x400mm	200x200, 300x300, 400x400, 600x400mm
EAN:	735010521 3892	735010521 3908	735010521 6863	735010521 6870
Max load:	50kg	50kg	50kg (Per screen)	50kg (Per screen)
Landscape / portrait:	Yes	Yes	Yes	Yes
Pole length:	150cm up to 300cm	150cm up to 300cm	150cm up to 300cm	150cm up to 300cm
Colour:	Black	White	Black	White
Accessories:	Yes (optional)	Yes (optional)	Yes (optional)	Yes (optional)

Enclosure 65" Floor to Ceiling Medium Black



Enclosure 65" Floor to Ceiling Medium White



Enclosure 75" Floor to Ceiling Medium Black



Enclosure 75" Floor to Ceiling Medium White



Model:	Enclosure 65" Floor to Ceiling Medium Black	Enclosure 65" Floor to Ceiling Medium White	Enclosure 75" Floor to Ceiling Medium Black	Enclosure 75" Floor to Ceiling Medium White
Recommended screen size:	65"	65"	75"	75"
VESA & Non-VESA Fixings:	200x200, 300x300, 400x400, 600x400mm	200x200, 300x300, 400x400, 600x400mm	200x200, 300x300, 400x400, 600x400mm	200x200, 300x300, 400x400, 600x400mm
EAN:	735010521 5711	735010521 5728	735010521 5735	735010521 5742
Max load:	50kg	50kg	75kg	75kg
Landscape / portrait:	Yes	Yes	Yes	Yes
Pole length:	150cm up to 300cm	150cm up to 300cm	150cm up to 300cm	150cm up to 300cm
Colour:	Black	White	Black	White
Accessories:	Yes (optional)	Yes (optional)	Yes (optional)	Yes (optional)

Enclosure 43" Wire B2B Black



Enclosure 50" Wire B2B Black



Enclosure 55" High Brightness Wire Black



Enclosure 55" High Brightness Wire Black



Model:	Enclosure 43" Wire Medium B2B Black	Enclosure 50" Wire Medium B2B Black	Enclosure 55" Wire F2C Medium Black	Enclosure 55" Wire F2C Medium White
Recommended screen size:	43"	50"	55"	55"
VESA & Non-VESA Fixings:	200x200, 300x300, 400x400, 600x400mm	200x200, 300x300, 400x400, 600x400mm	200x200, 300x300, 400x400, 600x400mm	200x200, 300x300, 400x400, 600x400mm
EAN:	735010521 6374	735010521 3946	735010521 7470	735010521 7463
Max load:	30kg (Per screen)	30kg (Per screen)	30kg	50kg
Landscape / portrait:	Yes	Yes	Yes	Yes
Wire length:	150cm	150cm	150cm up to 300cm	150cm up to 300cm
Colour:	Black	Black	Black	Black
Accessories:	Yes (optional)	Yes (optional)	Yes (optional)	Yes (optional)

Floormount Indoor Totem 55"



Enclosure Totem 55" Wheelbase Indoor



Enclosure Totem 55" Floorbase Indoor



Enclosure Totem Covered 55" Floormount



	Model: Floormount Indoor Totem 55"	Enclosure Totem 55" Wheelbase Indoor	Enclosure Totem 55" Floorbase Indoor	Enclosure Totem Covered 55" Floormount
Recommended screen size:	55"	55"	55"	55"
VESA & Non-VESA Fixings:	200x200, 300x300, 400x400, 400x500mm	200x200, 300x300, 400x400, 400x500mm	200x200, 300x300, 400x400, 400x500mm	200x200, 300x300, 400x400, 400x500mm
EAN:	735010521 4776	735010521 4837	735010521 4820	735010521 5308
Max load:	35kg	35kg	35kg	35kg
Landscape / portrait:	Portrait	Portrait	Portrait	Portrait
Pole length:	---	---	---	---
Colour:	Black	Black	Black	Black
Accessories:	Yes (optional)	Yes (optional)	Yes (optional)	Yes (optional)

Enclosure Totem Covered 55" Wheelbase



Enclosure Totem Covered 55" Floorbase



	Model: Enclosure Totem Covered 55" Wheelbase	Enclosure Totem Covered 55" Floorbase
Recommended screen size:	55"	55"
VESA & Non-VESA Fixings:	200x200, 300x300, 400x400, 400x500mm	200x200, 300x300, 400x400, 400x500mm
EAN:	735010521 5315	735010521 5292
Max load:	35kg	35kg
Landscape / portrait:	Portrait	Portrait
Colour:	Black	Black
Accessories:	Yes (optional)	Yes (optional)

Enclosure Totem 65" Floorbase Indoor



Enclosure Totem 65" Back to Back Floorbase Indoor



Enclosure B2B Totem 43" Floormount with Base



Enclosure B2B Totem 55" Floormount with Base



	Model: Enclosure Totem 65" Floorbase Indoor	Enclosure Totem 65" Back to Back Floorbase Indoor	Enclosure B2B Totem 43" Floormount with Base	Enclosure B2B Totem 55" Floormount with Base
Recommended screen size:	65"	65"	43"	55"
VESA & Non-VESA Fixings:	200x200, 300x300, 400x400, 400x500mm	200x200, 300x300, 400x400, 400x500mm	200x200, 300x300, 400x400, 400x500mm	200x200, 300x300, 400x400, 400x500mm
EAN:	735010521 6930	735010521 6947	735010521 5438	735010521 5445
Max load:	35kg	35kg	35kg	35kg
Landscape / portrait:	Portrait	Portrait	Portrait	Portrait
Colour:	Black	Black	Black	Black
Accessories:	Yes (optional)	Yes (optional)	Yes (optional)	Yes (optional)



M Pro Series
Philips LED TOTEM
FLOORMOUNT 1X2m
 EAN: 735010521 7074



M Pro Series
Philips LED TOTEM
FLOORBASE 1X2m
 EAN: 735010521 7067



M Pro Series
Philips LED TOTEM
FLOOR TO CEILING 1X2m
 EAN: 735010521 7050



M Pro Series
Quadpod 1X3 Leyard
 EAN: 735010521 7081



M Pro Series
Totem 1X6 Leyard
 EAN: 35010521 7098

Present digital information indoor through Multibrackets Totem LED solutions

These days many installers get the request to promote content with exceptional clarity in any storefront window. Multibrackets Pro Series LED Totems brings the ideal digital signage mounting solution for stores.

This product can be easily mounted on a stand or hung from a ceiling, giving retailers more options for positioning.

The smart and functional design creates a clean look offers flexibility in how valuable floor space is designed and utilized.

This dedicated mount allows businesses to create a platform for eye-catching content deliveries on a minimalistic mounting solution. By many installers considered the ideal display and mount solution for store applications.

A minimum of visible cables and screws from the outside. With a multitude of installer friendly features including concealed cable management for a professional appearance.

This is an incredibly versatile solution that can be adapted to suit a wide range of both retail and commercial applications.

The Retail Experience 2.0

Customer behaviours are changing

The crises of recent years have led to dramatic changes in consumer behaviour. The retail chains will now have to work hard to meet the ever-changing customer experience requirements to stay relevant.

Multibrackets can supply all indoor and outdoor mounting equipment, for any project.

With the help of large LED displays and other display solutions there is an opportunity to update your market place completely. The opportunity to build a close experience with the customer is created through online and instore messaging. Multibrackets has an extensive group of competent employees who help give your business a complete - "Retail Experience 2.0".

We can also help find suppliers of complete solutions where we are a part. We help you win to win the battle for the customer as the competition for the customer increases, it is important for stores to distinguish themselves, create experiences you cannot get when you visit the company online. Engaging customers on site is the key to the future. The answer to the question of a new retail experience will in many respects be digital signage which now includes LED displays. A LED panel consists of a larger number of smaller led modules. These can be put together to form almost any shape. As the image has a high resolution, opportunities are created to build almost

any type of digital experience, mixing digital and physical that many have not seen the likes of. This also appeals to the group that shops online as you can add a dimension to the online experience that you don't get via a small screen at home or on a mobile phone.

Project start

Starting this type of project takes time and financial resources need to be set aside. Planning is crucial. Multibrackets cooperates with the market's leading suppliers of LED panels, we offer the mounting

Indoor LED



Outdoor LED



solutions. So regardless of the project, big or small with LED displays sitting on the ceiling, along the walls or in the shop window. Multibrackets assist in project and help tailor these solutions for each new project and each individual shop - completely individually. This is what we call: Multibracket Tailormade.



Menu boards



Ceiling mounts



Shelf mounts



LED Columns





Customi



ized LED



Pro Series LED solutions

Supporting all major brands and mounting solutions

Inspired by AV installers

Multibrackets is committed to respond to industry needs. In cooperation with installers and display makers Multibrackets offers a complete line of Pro Series LED mounting solutions. Innovative features and recognized for delivering quality products that are both easy

to install and maintain, all at a fair TCO. With decades of audio-visual experience, our commitment to the create cutting-edge technology and Pro Series solutions has elevated us to become one of the industry's most innovative AV mounts manufacturer. Our Pro

Series LED solutions focus on high quality design, aesthetic results all at a good economy. Our team of LED professionals include everything from mechanical engineers to project managers, all working in close cooperation with our partners and their installers.

Highlights:

- . Simple installation
- . Cable management
- . Lightweight aluminum
- . Seamless result

Exclusive LED design for:

SAMSUNG

LG

PHILIPS

LEYARD

SAMSUNG

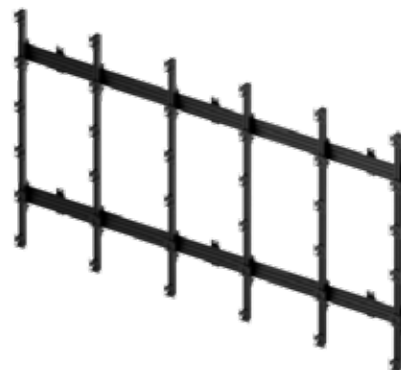

Image courtesy of Samsung Corp

M Pro Series LED Customized for SAMSUNG

IER / IEA / IFR Series

Samsung, the largest in the display industry, is a self-described manufacturer of LED Signage built for businesses. With Samsung, you can find the perfect display solution for all businesses. Capture everyone's attention with stunning images from LED Signage.



M Pro Series LED:	SAMSUNG - IER	SAMSUNG - IEA	SAMSUNG - IFR
Non Vesa Fixing:	Tailor made	Tailor made	Tailor made
EAN:	TBD	TBD	TBD
Max Load:	Tailor made for SAMSUNG IER/IEA/IFR Series	Tailor made for SAMSUNG IER/IEA/IFR Series	Tailor made for SAMSUNG IER/IEA/IFR Series
Bracket type:	Fixed	Fixed	Fixed
Landscape / Portrait:	Yes	Yes	Yes
Quick install:	Yes	Yes	Yes
Warranty:	5 years	5 years	5 years



Image courtesy of LG Corp

M Pro Series LED Customized for LG

LAS / LAE / LAE-Q / LAC Series

For a long time, LG Electronics has focused on developing new innovations in display technology. In LED technology, this is no exception. With a wide range of LED products, you can be sure that there is an LG solution that suits your needs.



M Pro Series LED:	LG - LAS	LG - LAE	LG - LAE-Q	LG - LAC
Non Vesa Fixing:	Tailor made	Tailor made	Tailor made	Tailor made
EAN:	TBD	TBD	TBD	TBD
Max Load:	Tailor made for SAMSUNG IER/IEA/IFR Series	Tailor made for SAMSUNG IER/IEA/IFR Series	Tailor made for SAMSUNG IER/IEA/IFR Series	Tailor made for SAMSUNG IER/IEA/IFR Series
Bracket type:	Fixed	Fixed	Fixed	Fixed
Landscape / Portrait:	Yes	Yes	Yes	Yes
Quick install:	Yes	Yes	Yes	Yes
Warranty:	5 years	5 years	5 years	5 years

Multibrackets

Sports Arena

Create next level fan experiences

When fans seek next-level live experiences sports facilities must focus on creating a modern, immersive venue. State-of-the-art sports display solutions can offer this.

Save time & cost, Multibrackets mounting arrives prepared

Multibrackets simplified mount solutions will help you install these in record time. For LED mounting we prepare all products to be ready to be installed, all details have been prepared and mounted in our production. You will save many hours of installation time and keep your installers happy. For LFD's Multibrackets Pro Series is both universal for most display brands and the products in the series are working together. This makes it possible to reach faster installation per LFD and all accessories can be used in the next installation.

So lets maximize the message throughout the Sports Arena with the right mounting!

Maximize your fan experience. With many years of combined experience, we and our distribution partners can help you reach a successful solution within Digital Signage and LED mounting. Increase revenue via

Dynamic displays and create a great customer experience throughout any sports facility, while also maximizing the opportunity to influence purchasing decisions and ultimately increase revenue. Improve efficiency. With many decades of combined experience, we and our distribution partners can help you reach a successful solution within Digital Signage, LFD and LED.

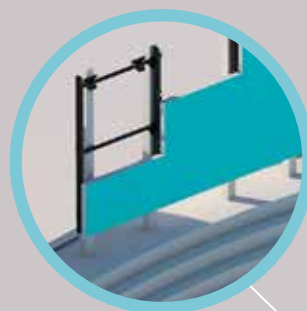

LED walls



Menuboard



Totem Pro Series

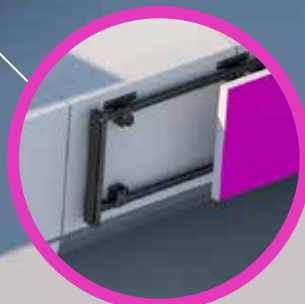

LED Walls



Odyssey + Press room



SHARP / NEC



Image courtesy of SHARP-NEC

M Pro Series LED Customized for SHARP / NEC

E / FE / FA Series

The impressive line up of Sharp/ NEC direct view indoor LED displays provide crystal clear images for the ultimate bezel-free visual experience. Vivid high bright images are viewable in superb clarity from any viewing distance and angle to ensure your message is received with the greatest impact.



M Pro Series LED:	SHARP/NEC - E	SHARP/NEC - FE	SHARP/NEC - FA
Non Vesa Fixing:	Tailor made	Tailor made	Tailor made
EAN:	TBD	TBD	TBD
Max Load:	Tailor made for SHARP / NEC	Tailor made for SHARP / NEC	Tailor made for SHARP / NEC
Bracket type:	Fixed	Fixed	Fixed
Landscape / Portrait:	Yes	Yes	Yes
Quick install:	Yes	Yes	Yes
Warranty:	5 years	5 years	5 years

PHILIPS



Image courtesy of PHILIPS

M Pro Series LED Customized for PHILIPS

6000/7000/8000/9000 Series

Direct view LED displays from Philips.

Experience total creative freedom with limitless Philips direct view LED displays, allowing you to combine as many displays as you like to form custom shapes of any size.

Engineering the future of direct view LED displays, brings Philips trusted quality, proven efficiency and total versatility together with global support.



M Pro Series LED:	PHILIPS - 6000	PHILIPS - 7000	PHILIPS - 8000	PHILIPS - 9000
Non Vesa Fixing:	Tailor made	Tailor made	Tailor made	Tailor made
EAN:	TBD	TBD	TBD	TBD
Max Load:	Tailor made for PHILIPS	Tailor made for PHILIPS	Tailor made for PHILIPS	Tailor made for PHILIPS
Bracket type:	Fixed	Fixed	Fixed	Fixed
Landscape / Portrait:	Yes	Yes	Yes	Yes
Quick install:	Yes	Yes	Yes	Yes
Warranty:	5 years	5 years	5 years	5 years



PRO SERIES

Custo



minimized

SHARP / NEC

PHILIPS

 **LG**

SAMSUNG



Customized for LG®

Powerful solutions for LG displays

The massively popular LG signage displays are a lineup Multibrackets supports with solutions that are designed exclusively for LG.

Video Wall mounts, Curved solutions Kiosks, LED solutions for floor, ceiling and wall and more.

With years of audio-visual manufacturing experience, Multibrackets can produce solutions for LG’s proprietary solutions you can trust. Well designed powerful solutions for LG with unmatched customer service.

Multibrackets are dedicated to provide top-of-the-line product support and service to LG partners.

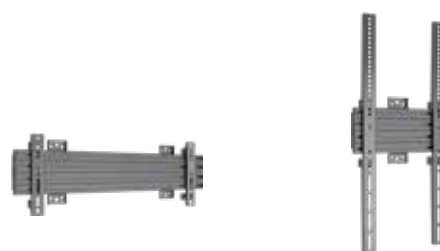

	Model name: MBSTH1U 600x200 Fixed	Model name: MBSTH1UP 200x600 Fixed
Recommended screen size:	40" - 100" stretched	40" - 100" stretched
VESA® & non-VESA fixings:	VESA 200x600mm	VESA 200x600mm
EAN:	735007373 4306	735007373 4313
Max load:	80kg	45kg
Bracket type:	Fixed	Fixed
Landscape/portrait:	Landscape	Portrait
Wall distance:	40 cm	40 cm
Colour (VESA arms):	Black	Black
Colour (Horizontal rail):	Black (Silver optional)	Black (Silver optional)
Warranty:	5 years	5 years



Model name:	M Wallmount Pro LG 110UM5J Tilt Black	M Floorstand Column Pro MBFSC1U 300 Fixed 1600X600	M Ceilingmount Pro LG 110UM5 Tilt Black	M Ceiling Mount Pro MBC4UHD
EAN:	735010521 3298	735010521 6749	735010521 4561	735007373 8878
VESA standard:	Max 1600x600mm	Max 1600x600mm	Max 1600x600mm	Max 600x400
Installation:	LG 110UM5J	LG 110UM5J, 110UM5K-B	LG 110UM5J, 110UM5K	86BH5F-M
Weight:	9 kg	24,5 kg + 40 kg	16,5 kg	54,5 kg
Max load:	80 kg	80 kg	80 kg	45 kg per screen
Measurements:	39.2x26.2x5cm	830x630x45mm + 865x355x133mm + 1160x140x138 mm	104.5 x 20 x 15 cm	105.0x51.5x18 cm
Material:	Steel, aluminum	Steel, Aluminium, Plastic (powder coated)	Steel, Aluminium, Plastic	Steel, Aluminium, Plastic
Surface finish:	Powder coating	Powder coating	Powder coating/Anodic Oxidation	Powder coating
Colour:	Black	Black	Black	Black
Warranty:	5 years	5 years	5 years	5 years

Customized for Samsung®

Dedicated solutions for Samsung displays

Samsung and Multibrackets co-operate on a wide range of Samsung proprietary solutions that Multibrackets design exclusively for Samsung displays and LED´s in Stockholm, Sweden.

Multibrackets produce everything - from specific Samsung proprietary brackets, Video Wall mounts, Kiosks, LED solutions for floor, ceiling and wall & more. After years of audio-visual manufacturing experience, Multibrackets can produce solutions for Samsung proprietary solutions you can trust.

Big or small projects are welcome. Delivering well designed powerfully built products for Samsung and adding unmatched customer service.

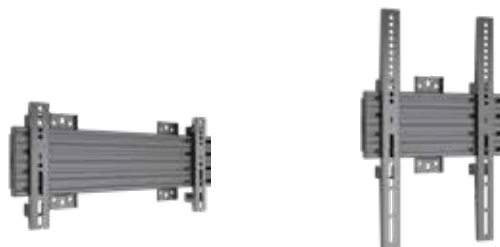

	Model name: MBSTH1U 400x200 Fixed	MBSTH1UP 200x400 Fixed
Recommended screen size:	SH37F (37")	SH37F (37")
VESA® & non-VESA fixings:	VESA 400x200mm	VESA 200x400mm
EAN:	735007373 7994	735007373 8007
Max load:	80 kg	45 kg
Bracket type:	Fixed	Fixed
Landscape/portrait:	Yes	Portrait
Wall distance:	40 cm	40 cm
Colour (VESA arms):	Black	Black
Colour (Horizontal rail):	Black (Silver optional)	Black (Silver optional)
Warranty:	5 years	5 years

Customized for Samsung®

Promote Storefront Content

OM46N-D / OM55N-D

Highlights:

- Ceilingmounts and floormounts dedicated to present bright content on a dual-display
- Modernizes and saves store space with its flexible design, offers more room to market your brand or products
- Dedicated side mounting points compatible with Samsung OMND back-to-back display models
- Highest level of finish to any client branding, bespoke colors available on request
- Semi Concealed hardware for sleek & stylish aesthetics
- A standalone floor base is optional
- Durable design, Multibrackets well known quality of materials and production process
- Complete hardware kit included

OM46N-D



Floormount Pro
OM46N-D



Floorbase Pro
OM46N-D



Wheelbase Pro
OM46N-D



Ceilingmount Pro
OM46N-D



**Ceilingmount
with extension kit**
Pro OM46N-D



Wiremount Pro
OM46N-D



OM55N-D



Floormount Pro
OM55N-D



Floorbase Pro
OM55N-D



Wheelbase Pro
OM55N-D



Ceilingmount Pro
OM55N-D



**Ceilingmount
with extension kit**
Pro OM55N-D



Wiremount Pro
OM55N-D



Customized for Philips®

Tailormade solutions for Philips displays

Close together with Philips Multibrackets has a lineup of solutions are designed exclusively for Philips displays & LED's.

The products range from Special brackets, Video Wall mounts, Kiosks, various LED solutions and more.

With years of audio-visual manufacturing experience, Multibrackets can produce solutions for Philips proprietary solutions you can trust. Well designed, and in many cases custom built products.

Multibrackets also has an outstanding high volume custom project capability.

We are dedicated to provide top-of-the-line product support and service for all Philips partners.



	Dual 32BDL-4050D	Dual 49BDL-4050D
Model name:	Dual 32BDL-4050D	Dual 49BDL-4050D
Rec. Screen Size:	32"	49"
VESA® & non-VESA fixings:	VESA 200x200mm	VESA 400x400mm
EAN:	735007373 7567	735007373 7598
Max Load:	30kg (Per screen)	30kg (Per screen)
Bracket Type:	Fixed	Fixed
Landscape / portrait:	Yes	Yes
Colour:	Black	Black
Warranty:	5 years	5 years



© 2024 Multibrackets Europe. Multibrackets is a registered trademark of Multibrackets Europe AB. All rights reserved. Other parties' marks are the property of their respective owners.



	Dual 32BDL-4050D	Triple 32BDL-4050D	Dual 32BDL-4050D	Dual 49BDL-4050D
Model name:	Dual 32BDL-4050D	Triple 32BDL-4050D	Dual 32BDL-4050D	Dual 49BDL-4050D
Rec. Screen Size:	32"	32"	32"	32"
VESA® & non-VESA fixings:	VESA 200x200mm	VESA 200x200mm	VESA 400x400mm	VESA 400x400mm
EAN:	735007373 7543	735007373 7550	735007373 7574	735007373 7581
Max Load:	30kg (Per screen)	30kg (Per screen)	30kg (Per screen)	30kg (Per screen)
Bracket Type:	Fixed	Fixed	Fixed	Fixed Fixed Fixed Fixed Fixed
Pole length:	80 - 150 cm	80 - 150 cm	80 - 150 cm	80 - 150 cm
Colour:	Black	Black	Black	Black
Warranty:	5 years	5 years	5 years	5 years
Accessories:	Cover plate	Cover plate	Cover plate	Cover plate

Customized for Sharp/NEC®



Powerful solutions for Sharp/NEC displays

Multibrackets Sweden has a lineup of solutions are designed exclusively for Sharp NEC displays - from special bracket solutions to Video Wall mounting, Trolleys, LED solutions for ceiling, wall or floor.

After years of audio-visual manufacturing experience. Multibrackets can produce solutions for Sharp NEC 's proprietary solutions with top-of-the-line product support and service you can trust.

With long term experience to tailor well designed Sharp NEC solutions, and outstanding high volume custom project capabilities Multibrackets are dedicated to provide support to Sharp NEC partners around Europe.



© 2023 Multibrackets Europe. Multibrackets is a registered trademark of Multibrackets Europe AB. All rights reserved. Other parties' marks are the property of their respective owners.



	M Tilt and Roll Easel	M Wallmount Pro MBW4U Tilt Black	M Wallmount Pro MBW1UP 400x600 Fixed Black
Model name:	M Tilt and Roll Easel	M Wallmount Pro MBW4U Tilt Black	M Wallmount Pro MBW1UP 400x600 Fixed Black
Rec. Screen Size:	32"-65"	40"-65"	40"-100"
VESA® & non-VESA fixings:	200x200, 300x300, 400x400, 400x600 mm	Adjustable from 100x100 to 400x400 max	From 100x100 to 400x600
EAN:	735007373 5280	735010521 5995	735007373 6935
Max Load:	50kg	35kg per screen (TÜV 30kg)	80kg
Colour:	Black	Black	Black
Warranty:	5 years	5 years	5 years

Customized for Sony, Vestel, BenQ, Hisense and others

Strong ties with major AV distributors and installers as well as industry leaders enable us to develop head-end system specific digital signage solutions to the market needs of your business.

We strive to always create simple and intuitive wall mounting solutions for digital signage display setups as well as in-room installations.

Our aim is to consistently find ways to improve on our digital signage product offering. Maybe it's time for your business to discover a new level of refinement with our Pro Series signage solutions.

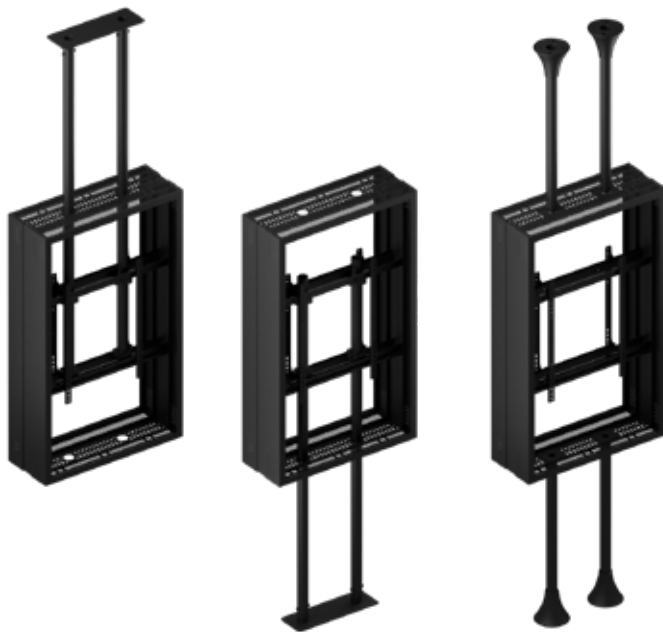

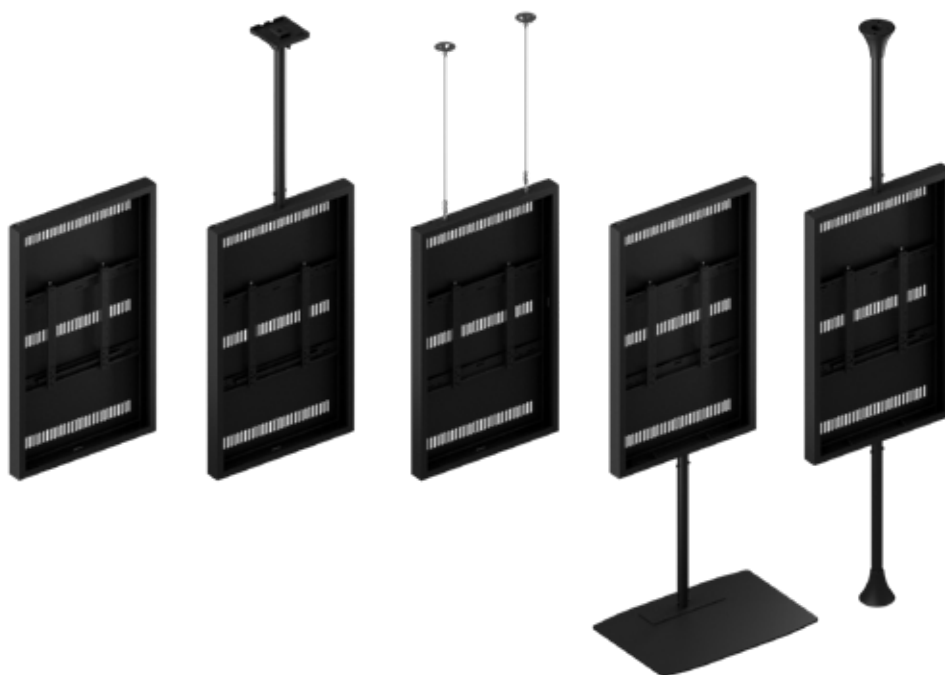
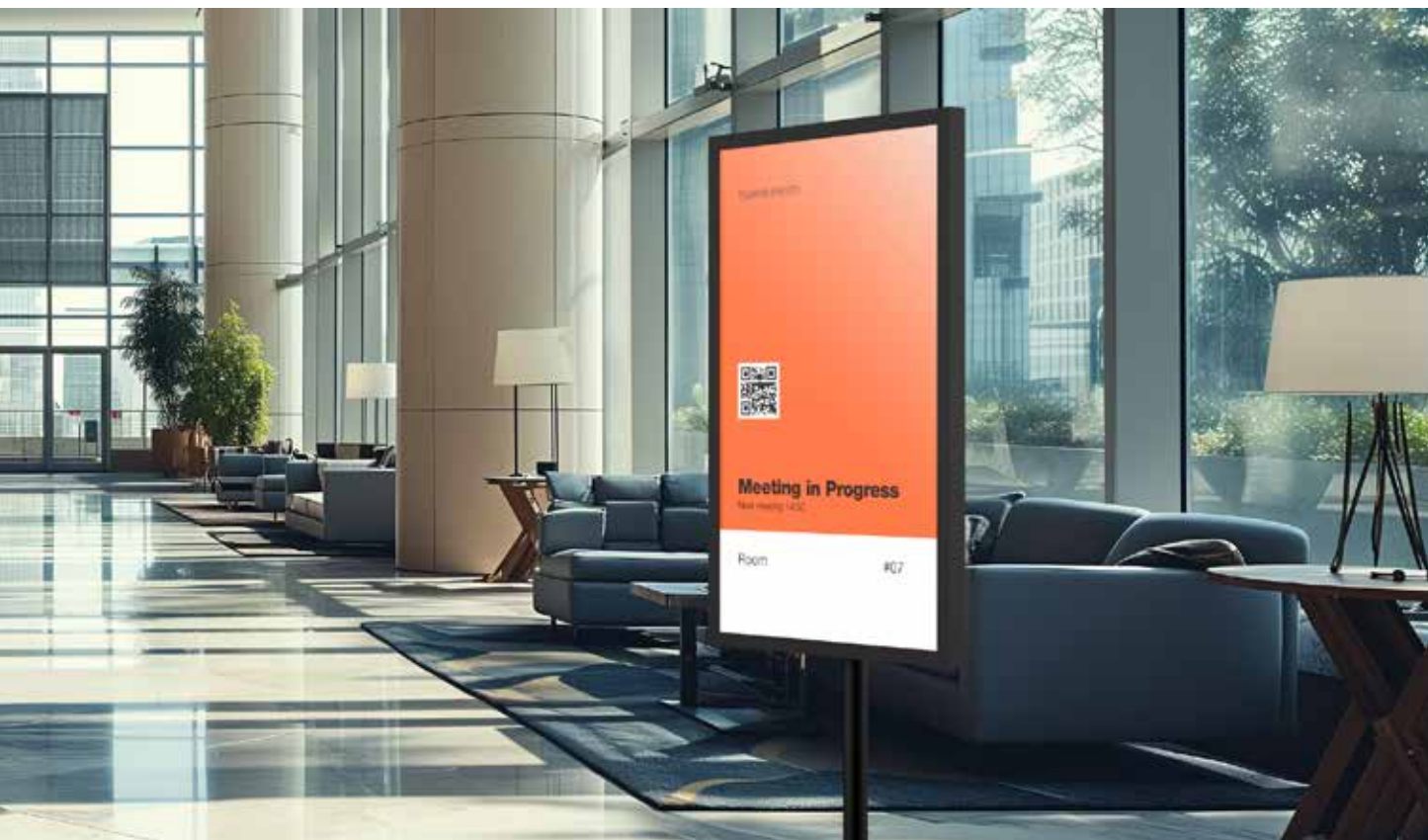

Pro Series Build Control rooms

Multiscreen display and monitor mounting for control rooms.

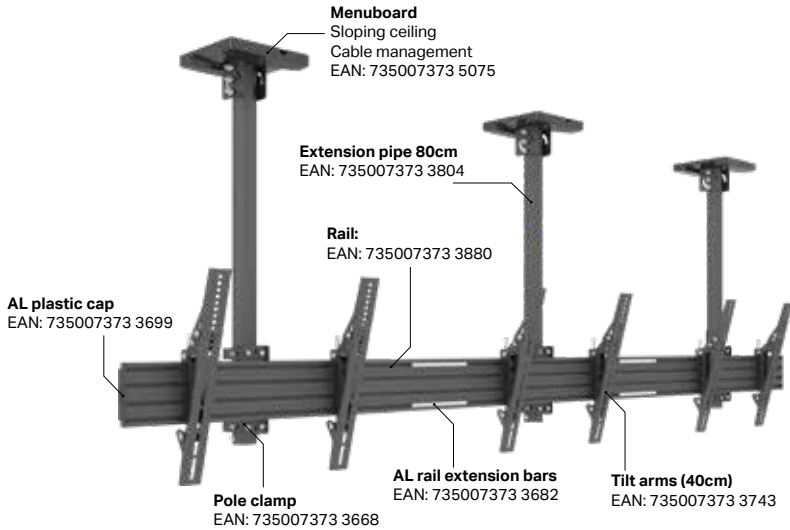

Highlights:

- Same mounting rail and system is being used
- Cable management keeps all cables in order
- Wide range of VESA handles all displays
- Easy to change design and outlook after time
- Industrial quality productrange

Pro Series Ceilingmounts

Our ceilingmount solutions are designed to handle both monitors and displays, mixed.

This way you can create any type of combination you need for your installation. Any flexible monitor or display can use the Pro Series Ceilingmount Flexarms.



VESA Flexarm Pro 400
EAN: 735007373 6331

**Pro Series
Video/ Monitorwall**

These videowalls use the unique Multibrackets Pro Series rail system. This system can handle anything from VESA 50 which are often found on smaller size monitors up to VESA 1000x600 used by large size displays. Combine large displays with monitors. Your imagination sets the limit.

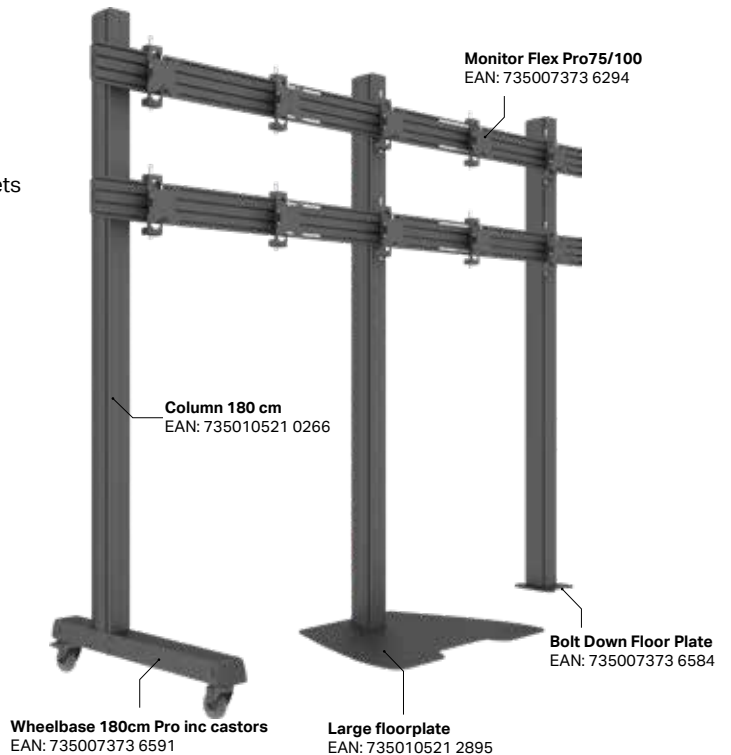

**Pro Series
Monitorstands**

If you plan to have a higher resolution monitorwall the Pro Series solves that as well. The railsystem uses monitormounts fixed or tilt and can then adopt close to any monitor on the markets. So wheter its small size 27" monitors or the new wide screen format monitors these monitorstands will solve your request.

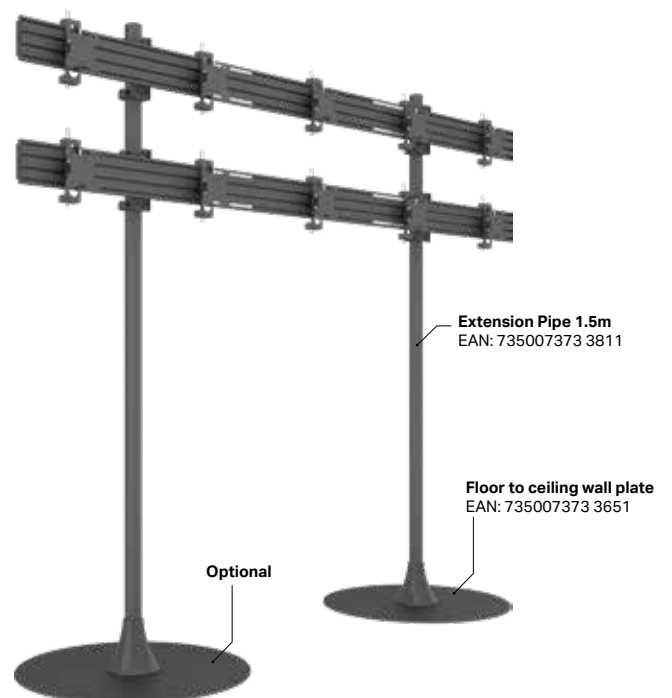



Pro Series Parts Go configure

Single AL rail 28cm (black)



EAN:	7350073735082
Length:	28cm
Colour:	Black
Material:	Aluminum
Warranty:	5 years

Single AL rail 48cm (black)



EAN:	7350073735082
Length:	48cm
Colour:	Black
Material:	Aluminum
Warranty:	5 years

Single AL rail 68cm (black)



EAN:	7350073733866
Length:	68cm
Colour:	Black
Material:	Aluminum
Warranty:	5 years

Single AL rail 100cm (black)



EAN:	7350073738021
Length:	100cm
Colour:	Silver
Material:	Aluminum
Warranty:	5 years

Dual Screen Rail 196cm



EAN:	7350073733873
Length:	196cm
Colour:	Black
Material:	Aluminum
Warranty:	5 years

Triple Screen Rail 348cm



EAN:	7350073733880
Length:	348cm
Colour:	Black
Material:	Aluminum
Warranty:	5 years

Rail Extension



EAN:	7350073733682
Length:	---
Colour:	Silver
Material:	Steel
Warranty:	5 years

Rail Extension Black



EAN:	7350073736867
Length:	---
Colour:	Black
Material:	Steel
Warranty:	5 years



Rail End Cover



EAN:	7350073733699
Colour:	Black
Material:	Plastic
Warranty:	5 years

Media Storage Slide Panel



EAN:	7350105213847
Colour:	Black
Material:	Steel
Warranty:	5 years

Curved Screen Rail Joiner



EAN:	7350073736348
Colour:	Black
Material:	Steel (SPCC Graded)
Warranty:	5 years

Cable Management Clip



EAN:	7350073737482
Colour:	Black
Material:	Plastic
Warranty:	5 years

Rail Stopper



EAN:	7350073737321
VESA® & non-VESA fixings:	---
Max load:	---
Bracket type:	---
Colour:	Silver
Material:	Steel
Warranty:	5 years

Fixed Arms 20cm



EAN:	7350073733903
VESA200 ,20cm:	VESA200 ,20cm
Max load:	30kg
Bracket type:	Fixed
Colour:	Black
Material:	Steel (SPCC Graded)
Warranty:	5 years

Fixed Arms 40cm



EAN:	7350073733866
Colour:	Black
Max load:	30kg
Bracket type:	Fixed
Colour:	Black
Material:	Steel (SPCC Graded)
Warranty:	5 years

Fixed Arms 60cm



EAN:	7350073733705
Colour:	Black
Max load:	30kg
Bracket type:	Fixed
Colour:	Black
Material:	Steel (SPCC Graded)
Warranty:	5 years

Fixed Arms 90cm



EAN: 7350073733774

Tilt Arms 20cm



EAN: 7350073733910

Tilt Arms 40cm



EAN: 7350073733743

Tilt Arms 60cm



EAN: 7350073733767

VESA® & non-VESA fixings:

VESA900 ,90cm

VESA200 ,20cm

Black

Black

Max load:

30kg

30kg

30kg

30kg

Bracket type:

Fixed

Tilt

Tilt

Tilt

Colour:

Black

Black

Black

Black

Material:

Steel (SPCC Graded)

Steel (SPCC Graded)

Steel (SPCC Graded)

Steel (SPCC Graded)

Warranty:

5 years

5 years

5 years

5 years

Tilt Arms 90cm



EAN: 7350073733774

M Push in Pop out VESA 400



EAN: 7350073734726

M Push in Pop out VESA 600



EAN: 7350105210464

Extender kit 600



EAN: 7350073734733

VESA® & non-VESA fixings:

VESA900 ,90cm

VESA400 ,40cm

Black

Black

Max load:

30kg

30kg

30kg

Bracket type:

Fixed

Push in Pop out arms

Push in Pop out arms

Colour:

Black

Black

Black

Black

Material:

Steel (SPCC Graded)

Steel (SPCC Graded)

Steel (SPCC Graded)

Steel (SPCC Graded)

Warranty:

5 years

5 years

5 years

5 years

40cm Micro-Adjustable Arms



EAN: 7350073733798

60cm Micro-Adjustable Arms



EAN: 7350105210457

M Monitor Fixed Pro 50/75/100



EAN: 7350073736300

M Monitor Flex Pro 50/75/100



EAN: 7350073736294

VESA® & non-VESA fixings:

VESA400 ,40cm

VESA400 ,40cm

50x50, 75x75, 100x100

50x50, 75x75, 100x100

Max load:

30kg

30kg

15kg

15kg

Bracket type:

Micro-Adjustable Arms

Push in Pop out arms

Fixed

Tilt

Colour:

Black

Black

Black

Black

Material:

Steel (SPCC Graded)

Steel (SPCC Graded)

Steel (SPCC Graded)

Steel (SPCC Graded)

Warranty:

5 years

5 years

5 years

5 years

VESA Flexarm Pro 400



EAN: 7350073736331

VESA Flexarm Pro Portrait



EAN: 7350105212499

Dual Pole bracket 600X900



EAN: 7350073738854

Dual Pole bracket 800X600



EAN: 7350073738847

VESA® & non-VESA fixings:

400x400mm

600x400mm

600X900mm

800x600mm

Colour:

Black

Black

Black

Black

Material:

Steel (SPCC Graded)

Steel (SPCC Graded)

Steel (SPCC Graded)

Steel (SPCC Graded)

Wallmount Plate Slim Small



EAN: 7350073736980
Colour: Black
Material: Steel (SPCC Graded)
Warranty: 5 years

Wallmount Plate Small



EAN: 7350073734184
Colour: Black
Material: Steel (SPCC Graded)
Warranty: 5 years

Wallmount Plate Large



EAN: 7350073733675
Colour: Black
Material: Steel (SPCC Graded)
Warranty: 5 years

Pole Clamp Plate



EAN: 7350073736119
Colour: Black
Material: Steel (SPCC Graded)
Warranty: 5 years

Single display plate from wall



EAN: 7350073737338
Colour: Black
Material: Steel (SPCC Graded)
Warranty: 5 years

B2b display plate from wall



EAN: 7350073737345
Colour: Silver
Material: Steel (SPCC Graded)
Warranty: 5 years

Ceiling Plate HD



EAN: 7350073734696
Colour: Black
Material: Steel (SPCC Graded)
Warranty: 5 years

Ceiling Plate with Cover Black



EAN: 7350073735075
Colour: Black
Material: Steel (SPCC Graded)
Warranty: 5 years

Ceiling Plate with Cover White



EAN: 7350073739028
Colour: White
Material: Steel (SPCC Graded)
Warranty: 5 years

I-Beam Clamp



EAN: 7350073736386
Colour: Black
Material: Steel (SPCC Graded)
Warranty: 5 years

Connecting plate



EAN: 7350073736973
Colour: Black
Material: Steel (SPCC Graded)
Warranty: 5 years

Dual bracket V-shape 32"-43"



EAN: 7350105212475
Colour: Black
Material: Steel (SPCC Graded)
Warranty: 5 years

Dual bracket V-shape 46"-65"



EAN: 7350105212482
Colour: Black
Material: Steel (SPCC Graded)
Warranty: 5 years

Extension Pipe 0.8m Black



EAN: 7350073733804
Colour: Black
Material: Steel (SPCC Graded)
Warranty: 5 years

Extension Pipe 1.5m Black







EAN: 7350073733811
Colour: Black
Material: Steel (SPCC Graded)
Warranty: 5 years

Extension Pipe 3m Black



EAN: 7350073733828
Colour: Black
Material: Steel (SPCC Graded)
Warranty: 5 years

	Extension Pipe 0.8m White	Extension Pipe 1.5m White	Extension Pipe 3m White	Chrome Extension Pipe 3m
				
EAN:	7350073736140	7350073736157	7350073736164	7350073733835
Colour:	White	White	White	Chrome
Material:	Steel (SPCC Graded)	Steel (SPCC Graded)	Steel (SPCC Graded)	Steel (SPCC Graded)
Warranty:	5 years	5 years	5 years	5 years

	Brass Extension Pipe 3m	External Pipe Cover Brass	External Pipe Cover Black	External Pipe Cover White
				
EAN:	7350073733842	7350073736225	7350073734221	7350073736201
Colour:	Brass	Brass	Black	White
Material:	Steel (SPCC Graded)	Plastic	Plastic	Plastic
Warranty:	5 years	5 years	5 years	5 years

	External Pipe Cover Chrome	Floor To Ceiling Plate Black	Floor To Ceiling Plate Brass	Internal Pole Joiner
				
EAN:	7350073736218	7350073733651	7350073736195	7350073734191
Colour:	White	Black	Brass	Chrome
Material:	Plastic	Plastic+Steel (SPCC Graded)	Plastic+Steel (SPCC Graded)	Plastic+Steel (SPCC Graded)
Warranty:	5 years	5 years	5 years	5 years

	Floor To Ceiling Plate White	Inner Ceiling Plate Cover Black	Extension Pipe 1.5m Black	Internal Pole Joiner
				
EAN:	7350073733859	7350073736270	7350073736287	7350073734191
Colour:	Black	Black	Black	Chrome
Material:	Plastic+Steel (SPCC Graded)	Plastic	Plastic	Steel (SPCC Graded)
Warranty:	5 years	5 years	5 years	5 years

Pole Clamp



EAN: 7350073733668
Colour: Black
Material: Steel (SPCC Graded)
Warranty: 5 years

Dual Pole Clamp



EAN: 7350073735068
Colour: Black
Material: Steel (SPCC Graded)
Warranty: 5 years

Pole Clamp Wall Bracket



EAN: 7350073734177
Colour: Black
Material: Steel (SPCC Graded)
Warranty: 5 years

Pole Drill Fixture



EAN: 7350073734214
Colour: Black
Material: Steel (SPCC Graded)
Warranty: 5 years

Truss Clamp 45-51 mm



EAN: 7350073734320
Colour: Black
Material: Steel (SPCC Graded)
Warranty: 5 years

Wheelbase 180cm Pro inc castors



EAN: 7350073736591
Colour: Black
Material: Aluminum +Steel(SPCC Graded)
Warranty: 5 years

Wheelbase 270cm Pro inc castors



EAN: 7350073736607
Colour: Black
Material: Aluminum +Steel(SPCC Graded)
Warranty: 5 years

Wheelbase 300cm Pro inc castors



EAN: 7350073736614
Colour: Black
Material: Aluminum +Steel(SPCC Graded)
Warranty: 5 years

Large Floorplate - column 150cm



EAN: 7350105212925
Colour: Black
Material: Aluminum +Steel(SPCC Graded)
Warranty: 5 years

Large Floorplate - column 180cm



EAN: 7350105212932
Colour: Black
Material: Aluminum +Steel(SPCC Graded)
Warranty: 5 years

Large Floorplate - column 270cm



EAN: 7350105212949
Colour: Black
Material: Aluminum +Steel(SPCC Graded)
Warranty: 5 years

Large Floorplate - column 300cm



EAN: 7350105212956
Colour: Black
Material: Aluminum +Steel(SPCC Graded)
Warranty: 5 years

Column 150cm



EAN: 7350105210259
Colour: Black
Material: Aluminum
Warranty: 5 years

Column 180cm



EAN: 7350105210266
Colour: Black
Material: Aluminum
Warranty: 5 years

Column 270cm



EAN: 7350105210273
Colour: Black
Material: Aluminum
Warranty: 5 years

Column 300cm



EAN: 7350105212550
Colour: Black
Material: Aluminum
Warranty: 5 years

Bolt Down Floor Plate



EAN: 7350073736584
Colour: Black
Material: Steel (SPCC Graded)
Warranty: 5 years

Base Plate



EAN: 7350073736447
Colour: Black
Material: Steel (SPCC Graded)
Warranty: 5 years

Large Floorplate



EAN: 7350105212895
Colour: Black
Material: Steel (SPCC Graded)
Warranty: 5 years

Bolt Down Pole Plate



EAN: 7350105210471
Colour: Black
Material: Steel (SPCC Graded)
Warranty: 5 years

Camera Shelf



EAN: 7350073736638
Colour: Black
Material: Steel (SPCC Graded)
Warranty: 5 years

Soundbar Holder



EAN: 7350073736645
Colour: Black
Material: Steel (SPCC Graded)
Warranty: 5 years

AV Shelf



EAN: 7350073736430
Colour: Black
Material: Steel (SPCC Graded)
Warranty: 5 years

Curved Display Distance



EAN: 7350105212284
Colour: Black
Material: Steel (SPCC Graded)
Warranty: 5 years

Wheelbase Supportbar 750mm



EAN: 7350105213045
Colour: Black
Material: Steel (SPCC Graded)
Warranty: 5 years

Wheelbase Supportbar 1200mm



EAN: 7350105213052
Colour: Black
Material: Steel (SPCC Graded)
Warranty: 5 years

Pole Clamp Ring



EAN: 7350105213571
Colour: Black
Material: Plastic+Steel (SPCC Graded)
Warranty: 5 years

Floor Support 1025-1075mm Black



EAN: 7350105213540
Colour: Black
Material: Plastic+Steel (SPCC Graded)
Warranty: 5 years

Ceiling Plate w. Weight Balance



EAN: 7350105213649
Colour: Black
Material: Steel (SPCC Graded)
Warranty: 5 years

Anti-theft Mini



EAN: 7350022735033
Colour: Chrome
Material: Steel (SPCC Graded)
Warranty: 5 years

Anti Theft Screws Pack M8



EAN: 7350105214318
Colour: Chrome
Material: Steel (SPCC Graded)
Warranty: 5 years

Anti Theft Screws Pack M5 M6



EAN: 7350105214325
Colour: Chrome
Material: Steel (SPCC Graded)
Warranty: 5 years

Adjustable Feet Pro



EAN: 7350073736577
Colour: Black
Material: Plastic+Steel (SPCC Graded)
Warranty: 5 years

Fixed Arm 126cm



EAN: 735010521 3922
Colour: Black
Material: Steel (SPCC Graded)
Warranty: 5 years

Extender Kit Push X Small 200x200



EAN: 735010521 5322
Colour: Black
Material: Steel (SPCC Graded)
Warranty: 5 years

Soundbar Holder XL



EAN: 735010521 5629
Colour: Black
Material: Steel (SPCC Graded)
Warranty: 5 years

Camera Shelf Column



EAN: 735010521 5858
Colour: Black
Material: Steel (SPCC Graded)
Warranty: 5 years

Camera Holder Large



EAN: 735010521 4219
Colour: Black
Material: Steel (SPCC Graded)
Warranty: 5 years

VESA Face Down Mount 200/300/400



EAN: 735010521 5902
Colour: Black
Material: Steel (SPCC Graded)
Warranty: 5 years

Dome Camera Mount



EAN: 735010521 6275
Colour: Black
Material: Steel (SPCC Graded)
Warranty: 5 years

Bolt Down Dual Pole Plate



EAN: 735010521 6305
Colour: Black
Material: Steel (SPCC Graded)
Warranty: 5 years

Large Floorbase



EAN: 735010521 4219
Colour: Black
Material: Steel (SPCC Graded)
Warranty: 5 years

Fixed Arms Wire 400x600 Single



EAN: 735010521 5902
Colour: Black
Material: Steel (SPCC Graded)
Warranty: 5 years

Fixed Arms Wire 400x600 Dual



EAN: 735010521 6275
Colour: Black
Material: Steel (SPCC Graded)
Warranty: 5 years

Wire Kit 3000mm



EAN: 735010521 6510
Colour: Black
Material: Steel (SPCC Graded)
Warranty: 5 years

Wire Kit 6000mm



EAN: 735010521 6527
Colour: Black
Material: Steel (SPCC Graded)
Warranty: 5 years

**Anti Theft Screws Pack
Enclosures/ Casings**



EAN: 735010521 5278
Colour: Chrome
Material: Stainless steel
Warranty: 5 years

**Enclosure Holder Small
220mm**



EAN: 735010521 6435
Colour: Black
Material: Steel
Warranty: 5 years

**Enclosure Holder Medium
340mm**



EAN: 735010521 6442
Colour: Black
Material: Steel
Warranty: 5 years

**Enclosure Holder Large
550mm**



EAN: 735010521 6435
Colour: Black
Material: Steel
Warranty: 5 years

**Floor to Ceiling Kit
Large Black**



EAN: 735010521 5698
Colour: Black
Material: Steel
Warranty: 5 years

**Floor to Ceiling Kit
Large White**



EAN: 735010521 5704
Colour: White
Material: Steel
Warranty: 5 years

**Enclosure Totem
Full Front Cover 55"**



EAN: 735010521 5285
Colour: Black
Material: Steel
Warranty: 5 years

**Wheelbase Indoor
Totem 55"**



EAN: 735010521 4790
Colour: Black
Material: Steel
Warranty: 5 years

Floorbase Indoor Totem 55"



EAN: 735010521 4783
Colour: Black
Material: Steel
Warranty: 5 years

Enclosure Safety Sheets

Function and freedom for the installer

This safety sheet made out of polycarbonate from Multibrackets are designed and manufactured for Multibrackets series of Enclosures. Designed with safety in mind to protect the displays from tampering, theft, and damage to displays.

This enclosure is a great solution for environments such as public areas, entrances hospitals and similar public areas. Experience the elegance of Multibrackets new Polycarbonate sheets designed to support the latest digital signage displays that is using a Multibrackets enclosure.



Model:	Safety Sheet Polycarbonate 13"	Safety Sheet Polycarbonate 22"	Safety Sheet Polycarbonate 24"	Safety Sheet Polycarbonate 32"
EAN:	735010521 5278	735010521 4875	735010521 4882	735010521 4899
For screen size:	13"	22"	24"	32"
Material:	Plastic	Plastic	Plastic	Plastic
Color:	Transparent	Transparent	Transparent	Transparent

Model:	Safety Sheet Polycarbonate 43"	Safety Sheet Polycarbonate 50"	Safety Sheet Polycarbonate 55"	Safety Sheet Polycarbonate 65"
EAN:	735010521 4035	735010521 4905	735010521 4042	735010521 4912
For screen size:	43"	50"	55"	65"
Material:	Plastic	Plastic	Plastic	Plastic
Color:	Transparent	Transparent	Transparent	Transparent

Model:	Safety Sheet Polycarbonate 75"
EAN:	735010521 4929
For screen size:	75"
Material:	Plastic
Color:	Transparent

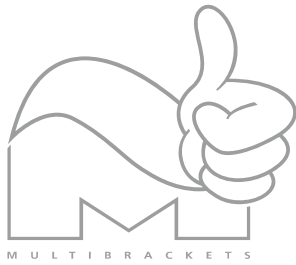

**Everything starts with you.
For us to create great products it always
begins with putting you the user at the heart
of everything we do."**

Mission

We are on a mission to create products that are simple to install and use, that excites and solves our clients daily needs - everyday, all year around. Based in Stockholm, Sweden we design, develop and market AV Equipment. But we do it our way. Armed with a genuine passion for new technology and user centric innovation, we take a product and give it a little bit of Multibrackets magic!

About us

Founded in year 2000 we are a family owned business and represented in over 30 countries. Today we are considered one of the leaders in the rapidly changing environment of digital signage technology – together with our distributors we are providing hardware and services to enable the full value from idea to a ready product. With one of the most comprehensive product lines in EU we supply Audio Visual Equipment for every need. Multibrackets reputation for innovative products is well known.

Become a partner

Stay ahead of your competition – Let us help you become a partner. Simply send us an email on support@multibrackets.com or go to our webpage <https://products.multibrackets.com/en/contact> for a contact with us at Multibrackets and we will help you with a distributor's contact. We look forward to your email.

Contact details

Multibrackets Europe AB
Döbelnsgatan 21, 11th floor
SE-111 40 Stockholm
SWEDEN

Reach us on email support@multibrackets.com or phone +46 (0)8 - 615 04 00

Sustainability

At Multibrackets we see sustainability like a journey. Being in the AV business means we have a responsibility to take care of the environment and everybody who plays a part in making our products. We are working hard to design sustainable products, minimize our impact on the environment, improve our sourcing and create a great workplace for our employees. Find out more about what we are doing and what we've already achieved on our web.

Copyright

This catalogue is protected by copyright laws. The graphic design, content, and images in this catalogue may not be reproduced, published displayed, or reproduced in any way, in whole or in part. This catalogue is considered the intellectual property of Multibrackets Europe AB, and we respectfully ask that you not copy, transmit, distribute, or create a derivative work based upon the content and materials of this catalogue. The content is also subject to the copyright laws of EU and the US (Act of 1976, Title 17 of the United States Code) and may not be copied for use in your publications or newsletters without prior written consent of Multibrackets Europe AB. If you are a customer of Multibrackets Europe AB and would like permission to use one of our articles in your company publication, please email and we would be happy to consider giving you permission to do so, as long as you would be willing to credit your source (Multibrackets Europe AB).

We reserve ourselves for printing errors

Printing errors. While we strive to display all our information as correct as possible, there sometimes occurs misprinting's and faulty information in catalogues. If this happens, and it should affect in any way the forms of, for example faulty product information, or the alike, we will inform you as soon as we notice, and amend it. Please note that we reserve ourselves the right to cancel any order that has been sold presented with a misprinted information. Editing, deleting, or modification of this catalogue: We reserve the right, for any reason, to edit this catalogue. That means, without advance notice, we may suspend, discontinue, edit, or delete current information, products, services, or any other content appearing in this catalogue.

Again, Welcome to Multibrackets Europe, one of the leading manufacturers of Audio Visual Equipment in Europe.



Multibrackets Europe AB

Phone: +46(0)8- 615 04 00 Mail: support@multibrackets.com

Postal address: Döbelnsgatan 21, 11th floor SE-111 40 Stockholm Sweden

