

8CH Digital SR Amplifier

DSA-300E



8CH DIGITAL SR AMPLIFIER DSA-300E



DSA-300E is a multi-channel amplifier for pro audio that is made based on technology from the Best Patent awarded DPA digital amplifier technology. It provides an optimum solution for distributed control system in a multi-broadcast system as it can output a maximum of 300 W×8CH(4 Ω) or 600 W×4CH(8 Ω) by connecting the output in Bridge mode. When a user wants to broadcast different sound sources to each individual places such as hotels and conference rooms the DSA-300E will offer pro audio broadcasting with S/N above 100 dB. Now experience highly efficient DSA-300E!

Educational facilities

Classroom, Seminar room etc.



Religious facilities

church, Buddhist temple etc.



Commercial facility

Hotel, Cafe, restaurant etc.



FEATURE

Digital Amplifier Maximum of 300 W×8CH

All new DSA-300E is a multi-channel power amplifier of 300 W×8CH(4 Ω)/150 W×8CH(8 Ω) or high output of 600 W×4CH(8 Ω) when used in Bridge mode. It is particularly suitable for venues that require high-quality BGM such as restaurant, hotel and conference centers. You can build a much more cost and space-efficient system as compare to previous 8CH analog amplifiers as it is lightweight and low heat. 2 U-sized.

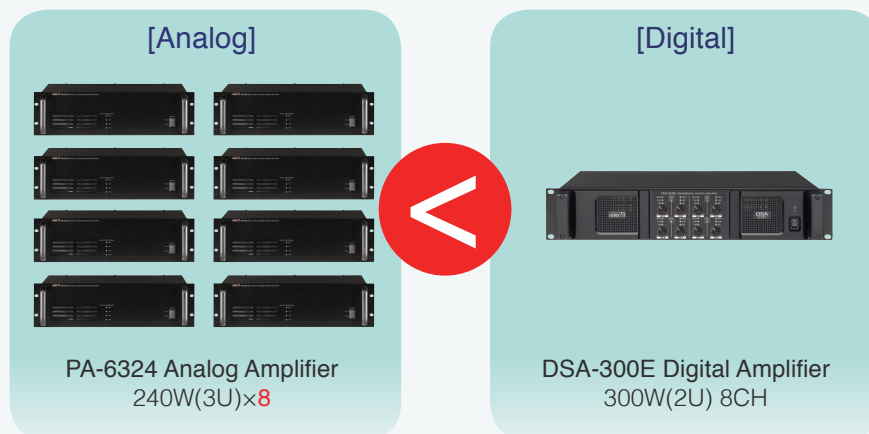

Simultaneous Broadcast

DSA-300E can send 8 different sound sources to 8 outputs simultaneously. For instance, it can send sound sources of the CD Player to the exhibition hall A and broadcast microphone to the exhibition hall B. This function can be utilized from small-sized venues like café and stores to large-sized venues like exhibition hall and department store.

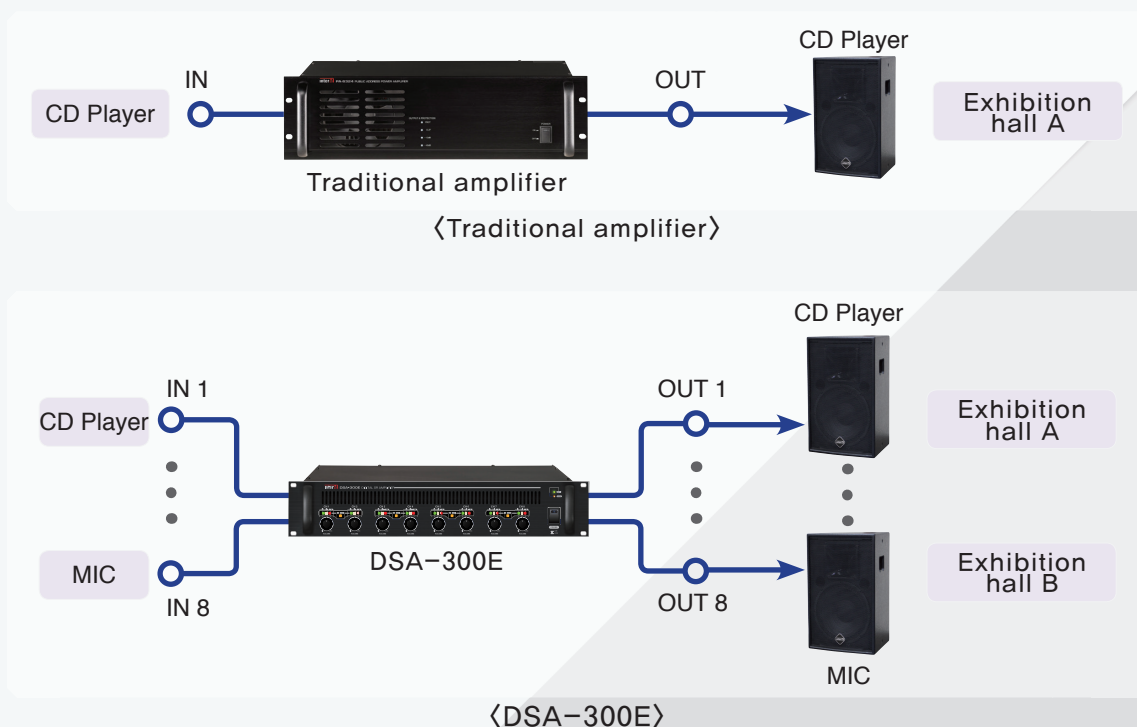

FEATURE

Maximum of 600W Output per Channel in Bridge Mode

DSA-300E provides Bridge mode which enables two connected channels to be one output. When used with Bridge mode, output of 600 W is possible. Place 'MODE SWITCH' on the rear panel to 'BRIDGED' and Bridge mode LED on the front panel lights up. If every channel is on Bridge mode, maximum of 600 Wx4CH(8 Ω) is available. Connect two adjacent even and odd channels to utilize Bridge mode. Insert audio signal to odd channel.

- * Bridge mode connection channel :
CH 1-CH 2/CH 3-CH 4/CH 5-CH 6/CH 7-CH 8

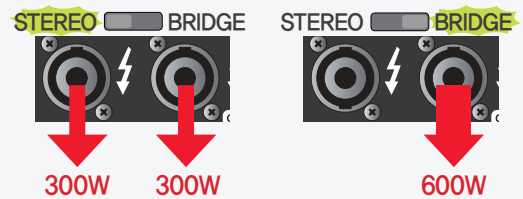

High-quality Sound of High S/N and Low THD

DSA-300E is a high-quality pro audio power amplifier with S/N over 100 dB and THD below 0.1 %. It perfectly suits for hotels', conference centers' and restaurants' the venues in need of supreme quality BGM play.

- * S/N : This is Signal to Noise value. Higher the value, clearer the sound.
- * THD : This is an acronym of Total Harmonics Distortion. Lower the value, better the sound.



LED Indicators

The backlit LED enables to monitor AC/DC power, STBY status, SIG -30 dB output level of each channel, Clip and Protect status. Also, with the volumes of each channel on the front panel, separate volume control is possible.

FRONT/REAR PANEL

FRONT PANEL

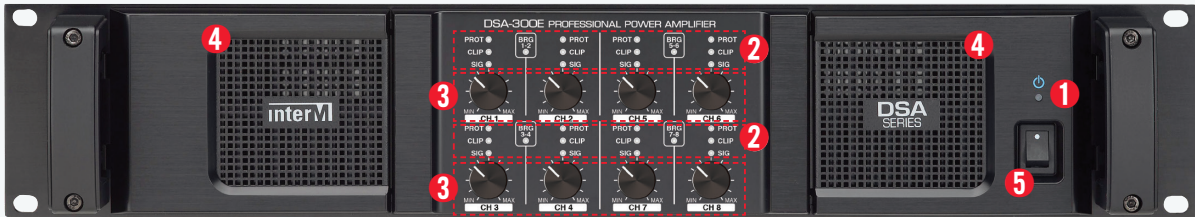

- 1 POWER LED
- 2 OUTPUT LEVEL, BRIDGED MODE INDICATOR (CH 1 ~ CH 8)
- 3 VOLUME CONTROL
- 4 FAN VENTS
- 5 POWER SWITCH

REAR PANEL

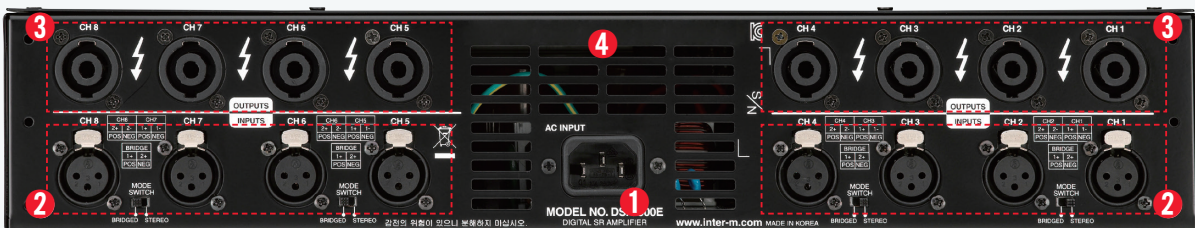

- 1 AC INPUT
- 2 XLR INPUT TERMINAL
- 3 OUTPUT TERMINAL
- 4 FAN VENTS

CONNECTION

· 다양한 동작모드 선택과 어플리케이션

STEREO MODE

INPUTS CH1, CH2로 입력된 신호가 각각 독립적으로 증폭되어 OUTPUTS CH1, CH2로 출력되는 모드

INPUTS CH1과 CH2 각각에 4Pole Speaker Socket을 사용하여 스피커에 연결

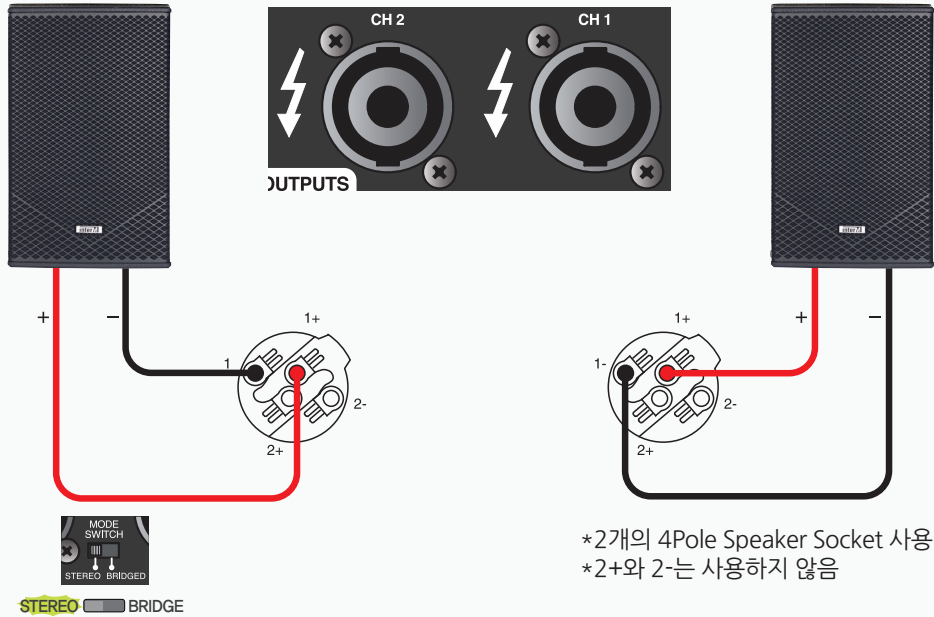

BRIDGE MODE

INPUTS CH 1로 입력된 신호를, 두 개의 앰프 모듈을 하나로 합쳐 두 배의 출력으로 만들어내는 모드

OUTPUTS CH1에 4Pole Speaker Socket 하나만을 사용하여 하나의 스피커에 연결

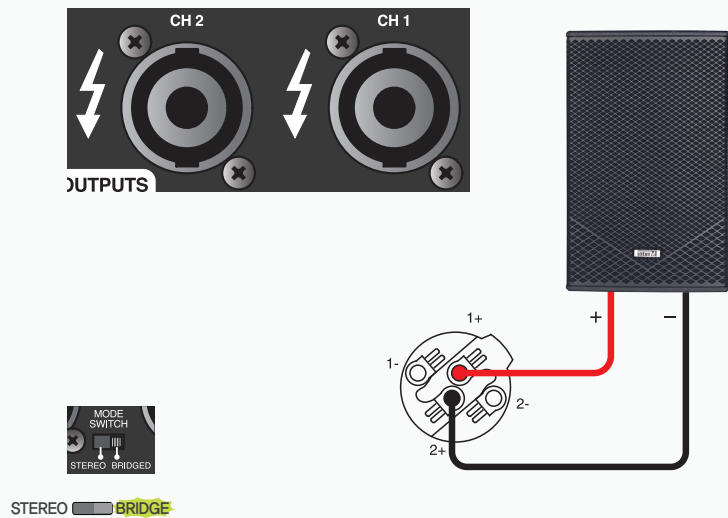

STEREO MODE를 이용해서 Bi-amp 형 스피커를 구동할 때

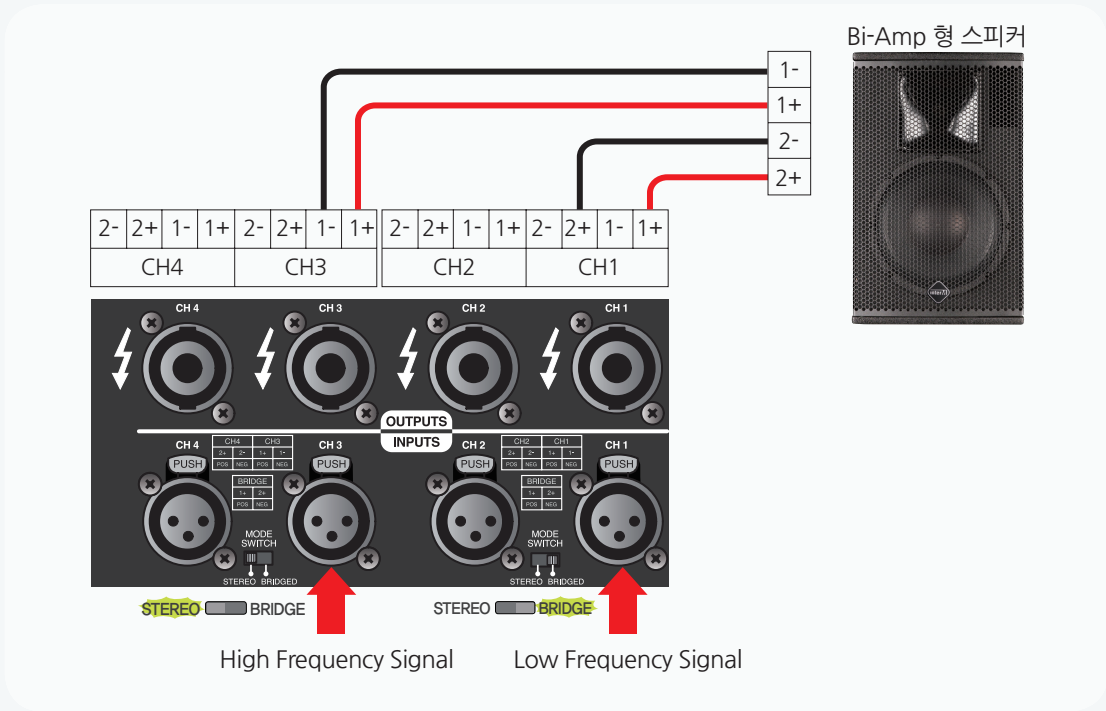

BRIDGE MODE를 이용해서 서브우퍼 스피커를 구동할 때

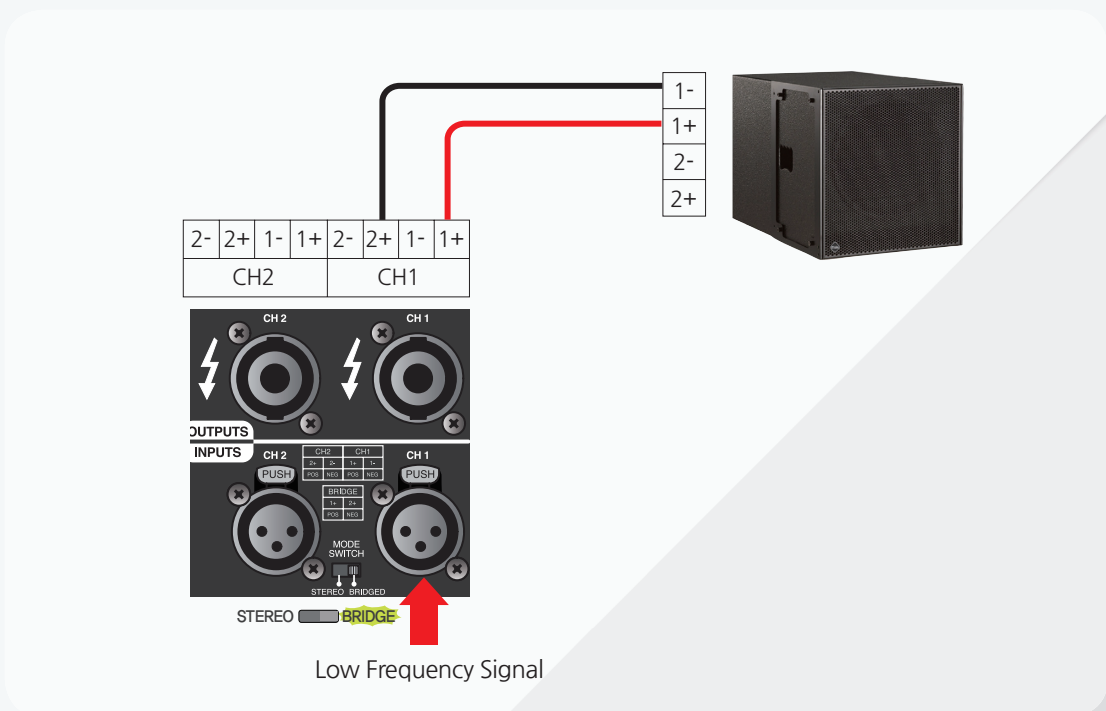

APPLICATION

Applications for Medium-sized Venues like Auditorium

With 8 channel amplifier DSA-300E, configure professional sound system conveniently! Through a single amplifier you can effectively configure the main speakers and monitors.

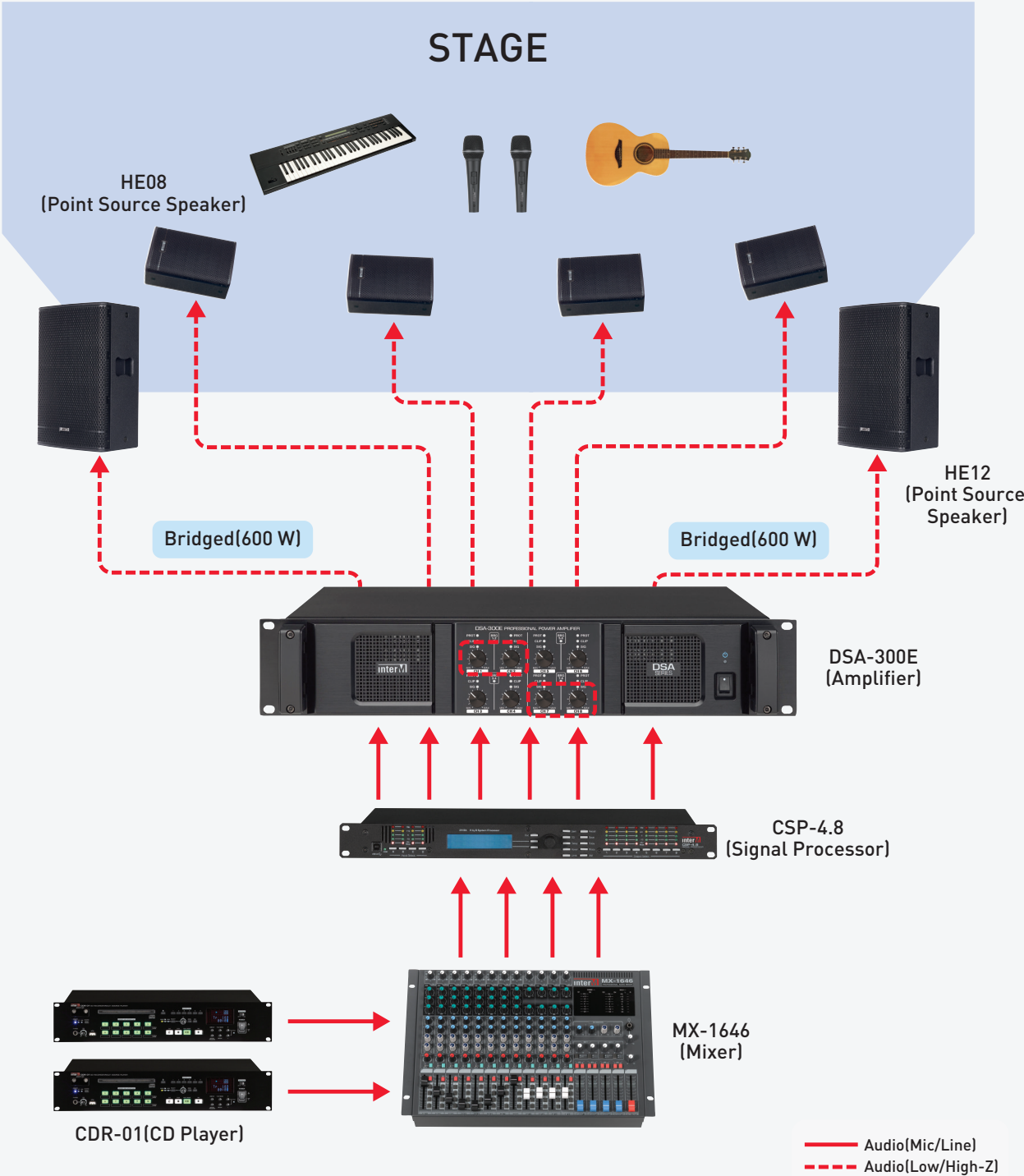

SPECIFICATIONS

		DSA-300E
Rated Output Power	8Ω per channel (STEREO)	150W
	4Ω per channel (STEREO)	300W
	8Ω per channel (BRIDGED)	600W
Input Sensitivity		1.23Vrms (4dBu)
Voltage Gain (STEREO)		29dB
Voltage Gain (BRIDGED)		35dB
THD (AES17, 1/3 rated output power)		Less than 0.3% (20kHz LPF)
S/N (20kHz LPF)		More than 100dB (20kHz LPF)
Frequency Response (1W, ±3dB)		20Hz ~ 20kHz
Output Circuit		Class D
Input Impedance		10kΩ Balanced
Indicator		SIG, CLIP, PROT, BRIDGED
Protection Circuit		Full Short Circuit, Thermal Protection Power ON/OFF Muting, DC Output Protection
Input Terminal		XLR Female
Output Terminal		4 Pole Speaker Socket
Operating Temperature		-10°C ~ +40°C/0% ~ 90%
Power Source		AC 220-240V, 50/60Hz
Power Consumption		480W (1/8W)
Weight (Set)		7.7kg/16.97lb
Dimensions (Set)		482×88×367mm/19×3.5×14.4in

NOTE

NOTE

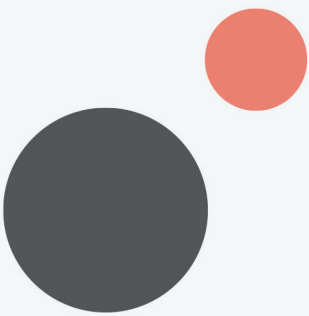

Inter-M Corp. (IMK)

719, Dobong-ro, Dobong-gu, Seoul, Korea
Overseas Sales Team

Tel_ +82-2-2289-8141~7 **Fax_** +82-2-2289-8149 **E-mail_** overseas@inter-m.com

www.inter-m.com

※ Design and specification are subject to be changed for the improvement of product quality without pre notice.

2017. 11. V5