

Synergy™ 2-Input 4K60Hz HDBaseT™ 3.0 In-Wall Transmitter

SW-120-TX3-US | SW-120-TX3-UK



Quickstart Guide

! WyreStorm recommends reading through this document in its entirety to become familiar with the product's features prior to starting the installation process.



! IMPORTANT! Installation Requirements

- Visit the product page to download the latest firmware, document version, additional documentation, and configuration tools.
- Read through the [Wiring and Connections](#) section for important wiring guidelines before creating or choosing premade cables.
- While this product supports CEC, WyreStorm cannot guarantee compatibility with all forms of CEC communication.

In the Box

- 1x SW-120-TX3-US/SW-120-TX3-UK In-Wall Transmitter
- 1x 1.8m USB2.0 Type-B to Type-A cable
- 1x 2m USB-C to USB-C Cable with Locking Connector (5Gbps)
- 1x 3-pin Terminal Block
- 1x 2-pin Terminal Block
- 1x Wall Plate (2-gang US) - (US model only)
- 4x Mounting Screws
- 1x Quickstart Guide (This Document)
- *20v 6a PSU Sold Separately

Basic Wiring Diagram

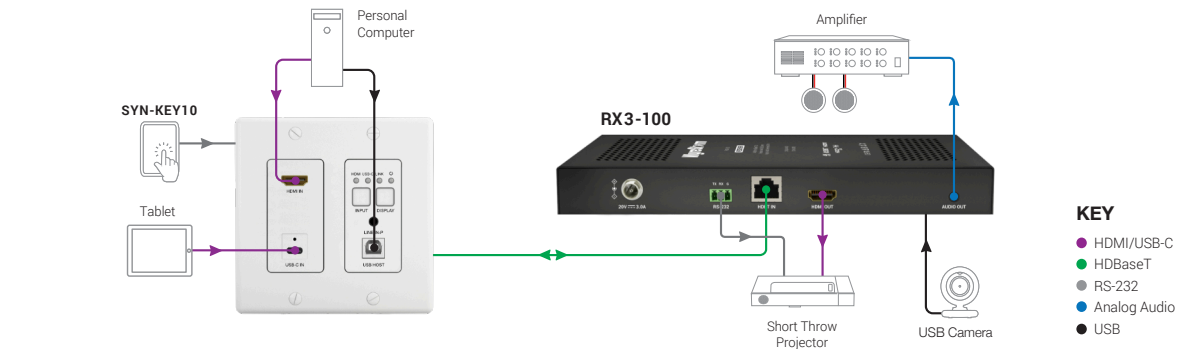

- KEY**
- HDMI/USB-C
 - HDBaseT
 - RS-232
 - Analog Audio
 - USB

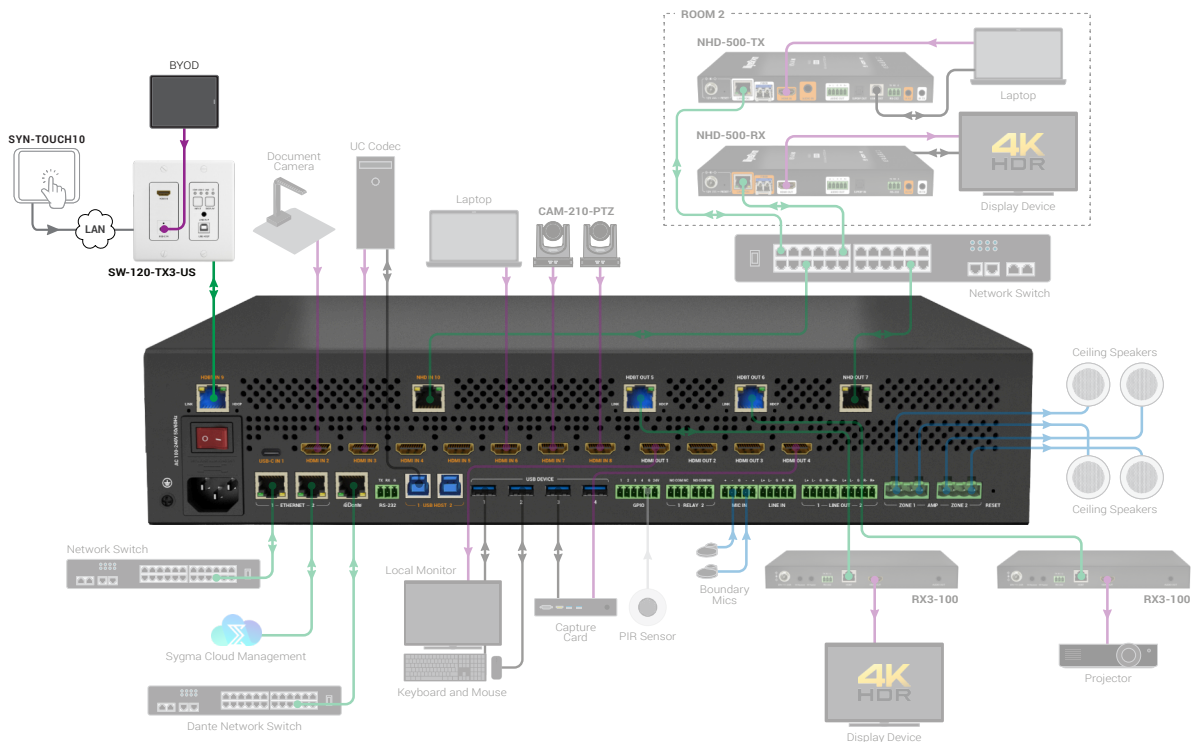

SW-120-TX3-US (Front/Rear)

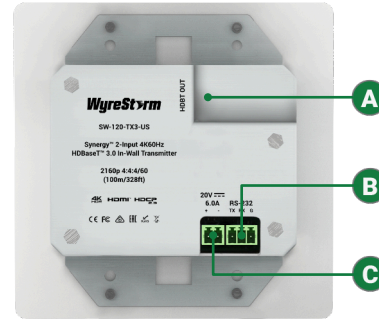
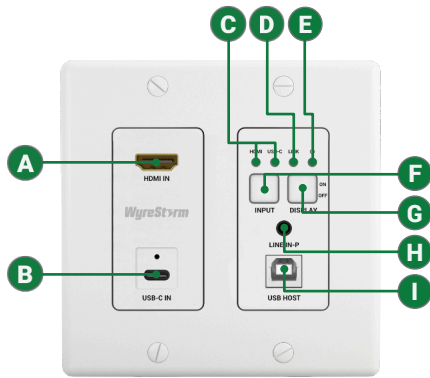

SW-120-TX3-UK (Front/Rear)

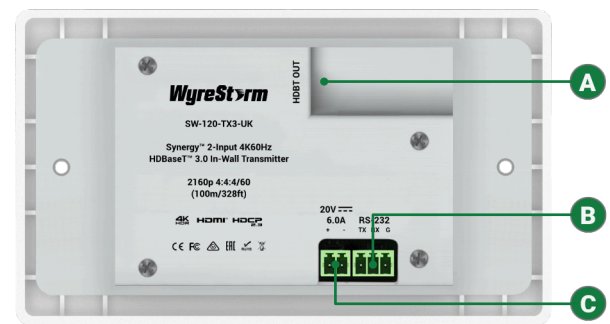
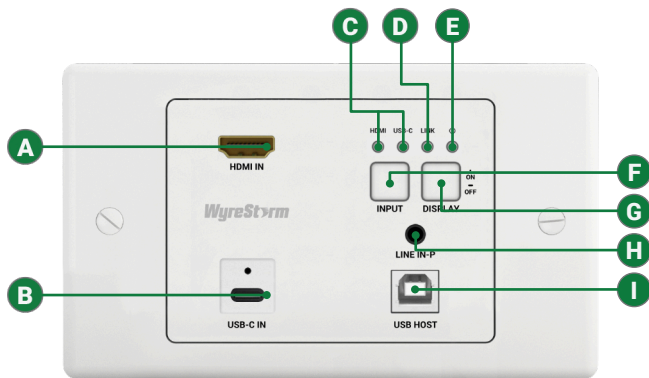

A HDMI Input	19-pin type A HDMI female Supports HDMI and DVI/D with adapter
B USB-C Input	USB3.1C port Supports alt-mode and device charging
C Source LED	On: Indicates the selected source
D Link LED	On: Indicates link with receiving device Off: No link with receiver/powerd off
E Power LED	Solid: The unit is powered On Off: The unit is powered Off
F Input Select	Press to manually change input
G Display Trigger	Short Press: Send power on trigger Long Press: Send power off trigger
H Audio Line In	3.5mm jack: 2ch analog audio input
I USB Host	USB Type B female Connection of USB Host device

A HDBT Output	8-pin RJ-45 female Connect the transmitter's HDBT OUT to receiver's HDBT IN .
B RS-232	3-pin Phoenix: Serial input for API control and 20v input
C Power Input	2-pin Phoenix: 20v 6A input

Wiring and Connections

WyreStorm recommends that all wiring for the installation is run and terminated prior to making connections to the switcher. Read through this section in its entirety before running or terminating the wires to ensure proper operation and to avoid damaging equipment.

IMPORTANT! Wiring Guidelines

- The use of patch panels, wall plates, cable extenders, kinks in cables, and electrical or environmental interference will have an adverse effect on signal transmission which may limit performance. Steps should be taken to minimize or remove these factors completely during installation for best results.
- WyreStorm recommends using pre-terminated HDMI and USB cables due to the complexity of these connector types. Using pre-terminated cables will ensure that these connections are accurate and will not interfere with the performance of the product.

- This product contains a USB-C connection that can be used as an audio/video input. When using this connection verify that the USB-C cable used supports audio/video functionality as not all USB-C cables support this requirement.

Cat6 Cable Performance Guide

0m	10m	20m	30m	40m	50m	60m	70m	80m	90m	100m
0ft	32ft	65ft	98ft	131ft	164ft	197ft	230ft	262ft	295ft	328ft

 4K/HD Transmission

WyreStorm recommends the use of shielded cable to minimize signal noise and interference

RS-232 Wiring

The SW-120-TX3-Ux uses a 3-pin RS-232 with no hardware flow control. Most control systems and computers are DTE where pin 2 is RX, this can vary from device to device. Refer to the documentation for the connected device for pin functionality to ensure that the correct connections can be made.

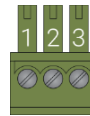

WyreStorm Connector		3rd Party Device
Pin 1	TX (Transmit)	---> To ---> RX (Receive)
Pin 2	RX (Receive)	---> To ---> TX (Transmit)
Pin 3	G (Ground)	---> To ---> G (Ground)

Baud Rate: 115200

Byte: 8bits

Parity: No

Stop Bit: 1

Note: The RS-232 port is software driven which allows the SW-120-TX3-Ux to distinguish between a self-switching command or whether a routed, device control command is being sent over HDBaseT

Power Wiring

The SW-120-TX3-Ux uses a 2-pin Terminal Connector if 60w USB-C device charging is required (20v 6a PSU not included)

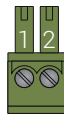

WyreStorm Connector	
Pin 1	PWR + (Positive)
Pin 2	PWR - (Negative)

Audio Connections

The audio connections use a 3.5mm (1/8in) TRS Stereo Jack.

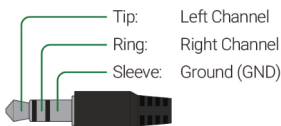

Troubleshooting

No or Poor Quality Picture (snow or noisy image)

- Verify that power is being supplied to the transmitter and receiving device.
- Verify that all HDMI, USB and HDBaseT connections are not loose and are functioning properly.
- Verify that the HDBaseT cable is properly terminated following EIA568B standard.
- Verify that the output resolution of the source and display is supported by this extender.
- If transmitting 4K, verify that the HDMI cables used are 4K rated.

No or Intermittent 3rd party Device Control

- Verify that the RS-232 cables are properly terminated following the [Wiring and Connections](#) section.

Troubleshooting Tips:

- WyreStorm recommends using a cable tester or connecting the cable to other devices to verify functionality.

Note: WyreStorm reserves the right to change product specification, appearance or dimensions of this product at any time without prior notice.

Warranty Information

WyreStorm Technologies LLC warrants that its products to be free from defects in material and workmanship under normal use for a period of five (5) years from the date of purchase. Refer to the Product Warranty page on wyrestorm.com for more details on our limited product warranty.



