



DLP® Projector

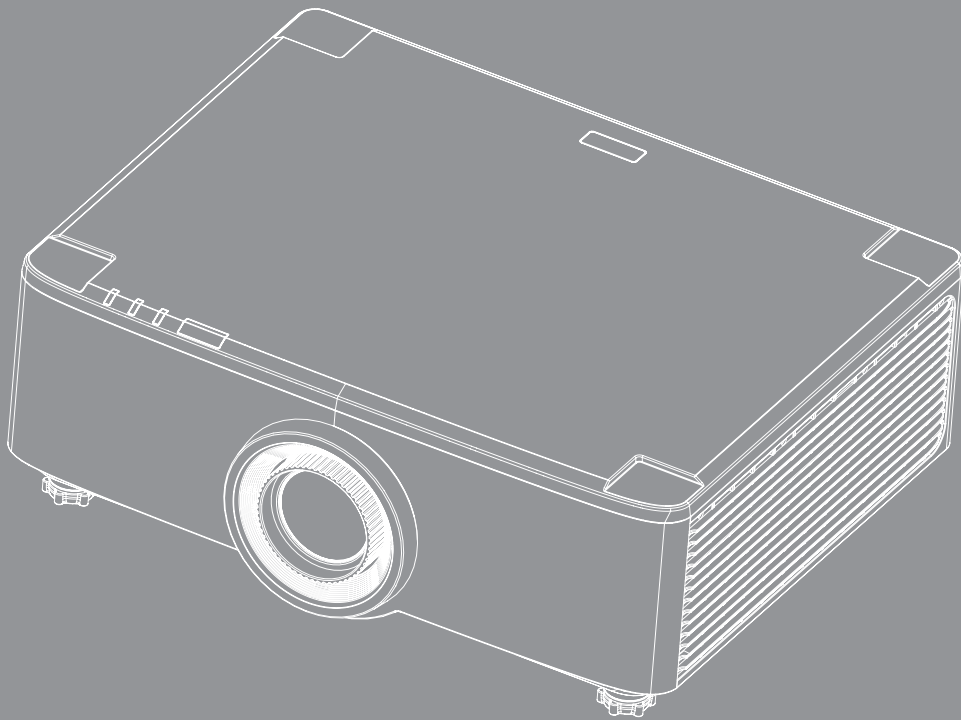

TABLE OF CONTENTS

SAFETY	4
<i>Important Safety Instruction</i>	4
<i>Cleaning the Lens</i>	5
<i>Laser Safety Information</i>	6
<i>3D Safety Information</i>	7
<i>Copyright</i>	7
<i>Disclaimer</i>	7
<i>Trademark Recognition</i>	8
<i>FCC Notice</i>	8
<i>Declaration of Conformity for EU countries</i>	8
<i>WEEE</i>	9
INTRODUCTION	10
<i>Package Overview</i>	10
<i>Standard Accessories</i>	10
<i>Product Overview</i>	11
<i>Connections</i>	12
<i>Keypad and LED Indicators</i>	13
<i>Remote Control</i>	14
SETUP AND INSTALLATION	16
<i>Connecting Sources to the Projector</i>	16
<i>Adjusting the Projector Image</i>	17
<i>Adjusting the Projection Image Shift</i>	18
<i>Adjusting the Projector's Zoom and Focus</i>	21
<i>Adjusting the Projector Position</i>	22
<i>Remote Setup</i>	23
USING THE PROJECTOR	25
<i>Powering On / Off the Projector</i>	25
<i>Home Screen Overview</i>	28
<i>System Date and Time</i>	28
<i>Projector Settings Menu (OSD)</i>	29
<i>System Settings Menu</i>	47
<i>Selecting an Input Source</i>	56
<i>Selecting an App</i>	57
<i>Multimedia mode and supported multimedia format</i>	58
<i>Viewing the status bar</i>	63

ADDITIONAL INFORMATION..... 64

Compatible Resolutions..... 64
RS232 Port Setting and Signals Connection..... 66
Installing and Cleaning the Dust Filter..... 67
Image Size and Projection Distance..... 68
Ceiling Mount Installation 70
Troubleshooting..... 71
LED Lightning Messages..... 73
Specifications 74
Optoma global offices..... 75

SAFETY

	The lightning flash with arrow head within an equilateral triangle is intended to alert the user to the presence of uninsulated "dangerous voltage" within the product's enclosure that may be of sufficient magnitude to constitute a risk of electric shock to persons.
	The exclamation point within an equilateral triangle is intended to alert the user to the presence of important operating and maintenance (servicing) instructions in the literature accompanying the appliance.

This product is herewith confirmed to comply with the requirements set out in the Council Directives on the Approximation of the laws of the Member States relating to Electromagnetic Compatibility Directive 2004/108/EEC.



Warning

- This product must not be used in residential areas.
- This product may cause interference if used in residential areas.

Such use must be avoided unless the user takes special measures to reduce electromagnetic emissions to prevent interference to the reception of radio and television broadcasts.

Important Safety Instruction



- Do not stare into the beam, RG2.
As with any bright source, do not stare into the direct beam, RG2 IEC 62471-5:2015.
- Do not block any ventilation openings. To ensure reliable operation of the projector and to protect from over heating, it is recommended to install the projector in a location that does not block ventilation. As an example, do not place the projector on a crowded coffee table, sofa, bed, etc. Do not put the projector in an enclosure such as a book case or a cabinet that restricts air flow.
- To reduce the risk of fire and/or electric shock, do not expose the projector to rain or moisture. Do not install near heat sources such as radiators, heaters, stoves or any other apparatus such as amplifiers that emits heat.
- Do not let objects or liquids enter the projector. They may touch dangerous voltage points and short out parts that could result in fire or electric shock.
- Do not use under the following conditions:
 - In extremely hot, cold or humid environments.
 - (i) Ensure that the ambient room temperature is within 5°C ~ 40°C (41°F ~ 104°F)
 - (ii) Relative humidity is 10% ~ 85%
 - In areas susceptible to excessive dust and dirt.
 - Near any appliance generating a strong magnetic field.
 - In direct sunlight.
- Do not use the unit if it has been physically damaged or abused. Physical damage/abuse would be (but not limited to):
 - Unit has been dropped.
 - Power supply cord or plug has been damaged.
 - Liquid has been spilled on to the projector.
 - Projector has been exposed to rain or moisture.
 - Something has fallen in the projector or something is loose inside.
- Do not place the projector on an unstable surface. The projector may fall over resulting in injury or the

projector may become damaged.

- Do not block the light coming out of the projector lens when in operation. The light will heat the object and could melt, cause burns or start a fire.
- Please do not open or disassemble the projector as this may cause electric shock.
- Do not attempt to service the unit yourself. Opening or removing covers may expose you to dangerous voltages or other hazards. Please call Optoma before you send the unit for repair.
- See projector enclosure for safety related markings.
- The unit should only be repaired by appropriate service personnel.
- Only use attachments/accessories specified by the manufacturer.
- Do not look into straight into the projector lens during operation. The bright light may harm your eyes.
- When switching the projector off, please ensure the cooling cycle has been completed before disconnecting power. Allow 90 seconds for the projector to cool down.
- Turn off and unplug the power plug from the AC outlet before cleaning the product.
- Use a soft dry cloth with mild detergent to clean the display housing. Do not use abrasive cleaners, waxes or solvents to clean the unit.
- Disconnect the power plug from AC outlet if the product is not being used for a long period of time.
- Do not setup the projector in places where it might be subjected to vibration or shock.
- Do not touch the lens with bare hands.
- Remove battery/batteries from remote control before storage. If the battery/batteries are left in the remote for long periods, they may leak.
- Do not use or store the projector in places where smoke from oil or cigarettes may be present, as it can adversely affect the quality of the projector performance.
- Please follow the correct projector orientation installation as non standard installation may affect the projector performance.
- Use a power strip and or surge protector. As power outages and brown-outs can KILL devices.

Cleaning the Lens

- Before cleaning the lens, be sure to turn off the projector and unplug the power cord to allow it to completely cool down.
- Use a compressed air tank to remove the dust.
- Use a special cloth for cleaning lens and gently wipe the lens. Do not touch the lens with your fingers.
- Do not use alkaline/acid detergents or volatile solvents such as alcohol for cleaning lens. If the lens is damaged due to the cleaning process, it is not covered by the warranty.



Warning

- Do not use a spray containing flammable gases to remove dust or dirt from the lens. This may cause a fire due to excessive heat inside the projector.
- Do not clean the lens if the projector is warming up as this may cause the lens' surface film to peel off.
- Do not wipe or tap the lens with a hard object.
- MOUNT ABOVE THE HEADS OF CHILDREN. The use of a ceiling mount is recommended with this product to place it above the eyes of children.

“WARNING: MOUNT ABOVE THE HEADS OF CHILDREN.”
Additional warning against eye exposure for close exposures less than 1 m.
 “AVERTISSEMENT : INSTALLER AU-DESSUS DE LA TÊTE DES ENFANTS.”
 Avertissement supplémentaire contre l'exposition oculaire pour des expositions à une distance de moins de 1 m.
 “警告:安装在高于孩童头顶处”
 关于小于1 m近距离眼睛暴露的附加警告
 「警告：安裝在高於兒童頭部處」
 針對1 m 以下近距離眼睛接觸的額外警告

Laser Safety Information

- Complies with 21 CFR 1040.10 and 1040.11 except for conformance as a Risk Group 2 LIP as defined in IEC 62471-5:Ed. 1.0. For more information see Laser Notice No. 57, dated May 8, 2019. IEC 60825-1:2014: CLASS 1 LASER PRODUCT - RISK GROUP 2

	<p>IEC/EN 60825-1:2014 CLASS 1 LASER PRODUCT RISK GROUP 2 Complies with 21 CFR 1040.10 and 1040.11 except for conformance as a Risk Group 2 LIP as defined in IEC 62471-5:Ed. 1.0. For more information see Laser Notice No. 57, dated May 8, 2019.</p>
	<p>IEC/EN 60825-1:2014 PRODUIT LASER DE CLASSE 1 GROUPE DE RISQUE 2 Conforme aux normes 21 CFR 1040.10 et 1040.11, à l'exception de la conformité en tant que LIP du groupe de risque 2 définie dans la CEI 62471-5: Ed. 1.0. Pour plus d'informations, voir l'avis au laser n° 57 du 8 mai 2019.</p>
	<p>IEC/EN 60825-1:2014 1類激光產品RG2危險等級 除了IEC 62471-5:Ed.1.0中定義的RG2 LIP 危險等級以外，要符合21 CFR 1040.10和1040.11，更多相關資訊，請參閱2019年5月8日的第57號激光公告。</p>
	<p>IEC/EN 60825-1:2014 1類激光產品RG2危險等級 除了IEC 62471-5:Ed.1.0中定義的RG2 LIP 危險等級以外，要符合21 CFR 1040.10和1040.11，更多相關資訊，請參閱2019年5月8日的第57號激光公告。</p>

- This projector has built-in Class 4 laser module. Disassembly or modification is very dangerous and should never be attempted.
- Any operation or adjustment not specifically instructed by the user's guide creates the risk of hazardous laser radiation exposure.
- Do not open or disassemble the projector as this may cause damage by the exposure of laser radiation.
- Do not stare into beam when the projector is on. The bright light may result in permanent eye damage.
- When turning on the projector, make sure no one within projection range is looking at the lens.
- Without following the control, adjustment or operation procedure may cause damage by the exposure of laser radiation.
- Adequate instructions for assembly, operation, and maintenance, including clear warnings concerning precautions to avoid possible exposure to laser and collateral radiation in excess of the accessible emission limits in Class 2.
- The Class A digital apparatus meets all requirements of the Canadian Interference-Causing Equipment Regulation. Interference-Causing Equipment Regulation.
- Cet appareil numérique de la class A respecte toutes les exigences du Règlement sur le matériel brouilleur du Canada.
- Notice is given to supervise children and to never allow them to stare into the projector beam at any distance from the projector.
- Notice is given to use caution when using the remote control for starting the projector while in front of the projection lens.
- Notice is given to the user to avoid the use of optical aids such as binoculars or telescopes inside the beam

3D Safety Information

Please follow all warnings and precautions as recommended before you or your child use the 3D function.

Warning

Children and teenagers may be more susceptible to health issues associated with viewing in 3D and should be closely supervised when viewing these images.

Photosensitive Seizure Warning and Other Health Risks

- Some viewers may experience an epileptic seizure or stroke when exposed to certain flashing images or lights contained in certain Projector pictures or video games. If you suffer from, or have a family history of epilepsy or strokes, please consult with a medical specialist before using the 3D function.
- Even those without a personal or family history of epilepsy or stroke may have an undiagnosed condition that can cause photosensitive epileptic seizures.
- Pregnant women, the elderly, sufferers of serious medical conditions, those who are sleep deprived or under the influence of alcohol should avoid utilizing the unit's 3D functionality.
- If you experience any of the following symptoms, stop viewing 3D pictures immediately and consult a medical specialist: (1) altered vision; (2) light-headedness; (3) dizziness; (4) involuntary movements such as eye or muscle twitching; (5) confusion; (6) nausea; (7) loss of awareness; (8) convulsions; (9) cramps; and/ or (10) disorientation. Children and teenagers may be more likely than adults to experience these symptoms. Parents should monitor their children and ask whether they are experiencing these symptoms.
- Watching 3D projection may also cause motion sickness, perceptual after effects, disorientation, eye strain and decreased postural stability. It is recommended that users take frequent breaks to lessen the potential of these effects. If your eyes show signs of fatigue or dryness or if you have any of the above symptoms, immediately discontinue use of this device and do not resume using it for at least thirty minutes after the symptoms have subsided.
- Watching 3D projection while sitting too close to the screen for an extended period of time may damage your eyesight. The ideal viewing distance should be at least three times the screen height. It is recommended that the viewer's eyes are level with the screen.
- Watching 3D projection while wearing 3D glasses for an extended period of time may cause a headache or fatigue. If you experience a headache, fatigue or dizziness, stop viewing the 3D projection and rest.
- Do not use the 3D glasses for any other purpose than for watching 3D projection.
- Wearing the 3D glasses for any other purpose (as general spectacles, sunglasses, protective goggles, etc.) may be physically harmful to you and may weaken your eyesight.
- Viewing in 3D projection may cause disorientation for some viewers. Accordingly, DO NOT place your 3D PROJECTOR near open stairwells, cables, balconies, or other objects that can be tripped over, run into, knocked down, broken or fallen over.

Copyright

This publication, including all photographs, illustrations and software, is protected under international copyright laws, with all rights reserved. Neither this manual, nor any of the material contained herein, may be reproduced without written consent of the author.

© Copyright 2020

Disclaimer

The information in this document is subject to change without notice. The manufacturer makes no representations or warranties with respect to the contents hereof and specifically disclaims any implied warranties of merchantability or fitness for any particular purpose. The manufacturer reserves the right to revise this publication and to make changes from time to time in the content hereof without obligation of the manufacturer to notify any person of such revision or changes.

Trademark Recognition

Kensington is a U.S. registered trademark of ACCO Brand Corporation with issued registrations and pending applications in other countries throughout the world.

HDMI, the HDMI Logo, and High-Definition Multimedia Interface are trademarks or registered trademarks of HDMI Licensing LLC in the United States and other countries.

DLP®, DLP Link and the DLP logo are registered trademarks of Texas Instruments and BrilliantColor™ is a trademark of Texas Instruments.

IBM is a trademark or registered trademark of International Business Machines, Inc.

Microsoft, PowerPoint, and Windows are trademarks or registered trademarks of Microsoft Corporation.

HDBaseT™ and the HDBaseT Alliance logo are trademarks of the HDBaseT Alliance.

Adobe and Acrobat are trademarks or registered trademarks of Adobe Systems Incorporated.

All other product names used in this manual are the properties of their respective owners and are Acknowledged.

FCC Notice

This device complies with Part 15 of the FCC rules. Operation is subject to the following two conditions

(1) This device may not cause harmful interference,

(2) This device must accept any interference received; including interference that may cause undesired operation.

This Equipment has been tested and found to comply with the limits for a Class A digital device, pursuant to part 15 of the FCC Rules. These limits are designed to provide reasonable protection against harmful interference when the equipment is operated in a commercial environment. This equipment generates, uses, and can radiate radio frequency energy and, if not installed and used in accordance with the instruction manual, may cause harmful interference to radio communications.

Operation of this equipment in a residential area is likely to cause harmful interference in which case the user will be required to correct the interference at his own expense.

Notice: Shielded cables

All connections to other computing devices must be made using shielded cables to maintain compliance with FCC regulations.

Caution

Changes or modifications not expressly approved by the manufacturer could void the user's authority, which is granted by the Federal Communications Commission, to operate this projector.

Operation Conditions

This device complies with Part 15 of the FCC Rules. Operation is subject to the following two conditions:

1. This device may not cause harmful interference and
2. This device must accept any interference received, including interference that may cause undesired operation.

Notice: Canadian users

This Class B digital apparatus complies with Canadian ICES-003.

Remarque à l'intention des utilisateurs canadiens

Cet appareil numérique de la classe B est conforme à la norme NMB-003 du Canada.

Declaration of Conformity for EU countries

- EMC Directive 2014/30/EC (including amendments)
- Low Voltage Directive 2014/35/EC
- RED 2014/53/EU (if product has RF function)

WEEE



Disposal instructions

Do not throw this electronic device into the trash when discarding. To minimize pollution and ensure utmost protection of the global environment, please recycle it.

CAUTION: This equipment is equipped with a three-pin grounding-type power plug. Do not remove the grounding pin on the power plug. This plug will only fit a grounding-type power outlet. This is a safety feature. If you are unable to insert the plug into the outlet, contact an electrician. Do not defeat the purpose of the grounding plug.



INTRODUCTION

Package Overview

Carefully unpack and verify that you have the items listed below under standard accessories. Some of the items under optional accessories may not be available depending on the model, specification and your region of purchase. Please check with your place of purchase. Some accessories may vary from region to region.

The warranty card is only supplied in some specific regions. Please consult your dealer for detailed information.

Standard Accessories

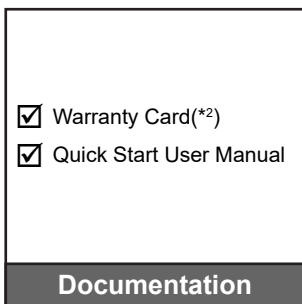
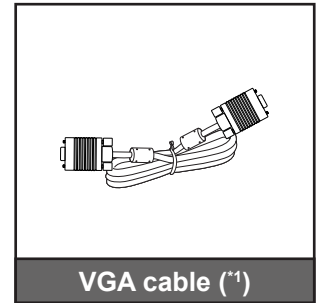
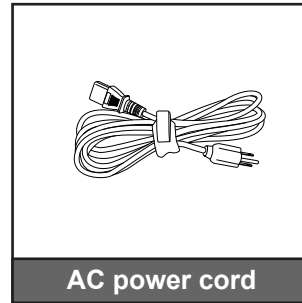
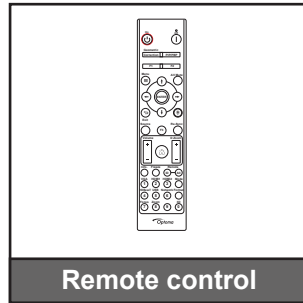
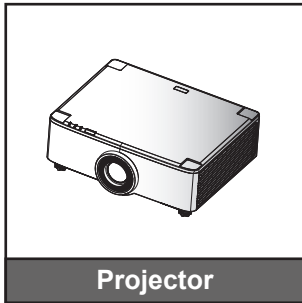

Note:

- The actual remote control may vary depending on the region.
- (*1) The VGA cable is only supplied in some specific regions.
- (*2) For European warranty information, please visit www.optoma.com.



Please scan the OPAM warranty QR code or visit the following URL:
<https://www.optoma.com/us/support/warranty-and-return-policy/>



Please scan the QR code or visit the following URL: <https://www.optoma.com/support/download>

INTRODUCTION

Product Overview

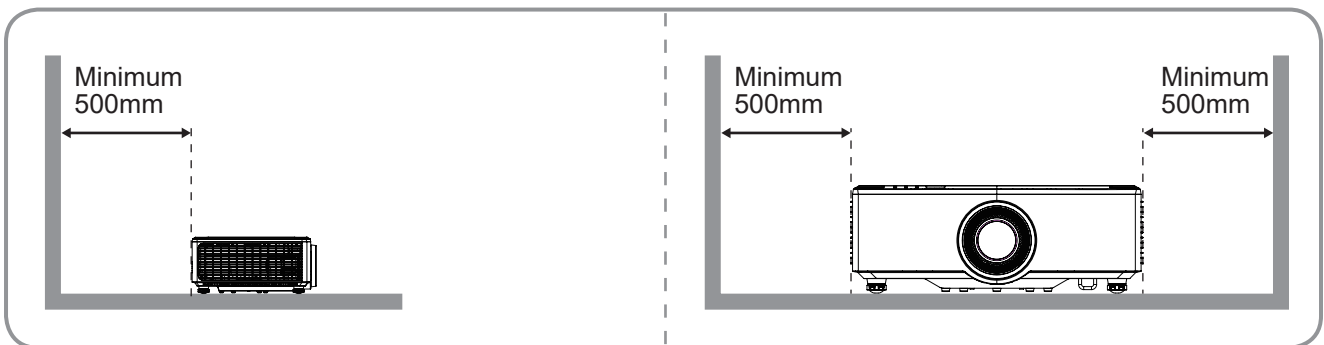
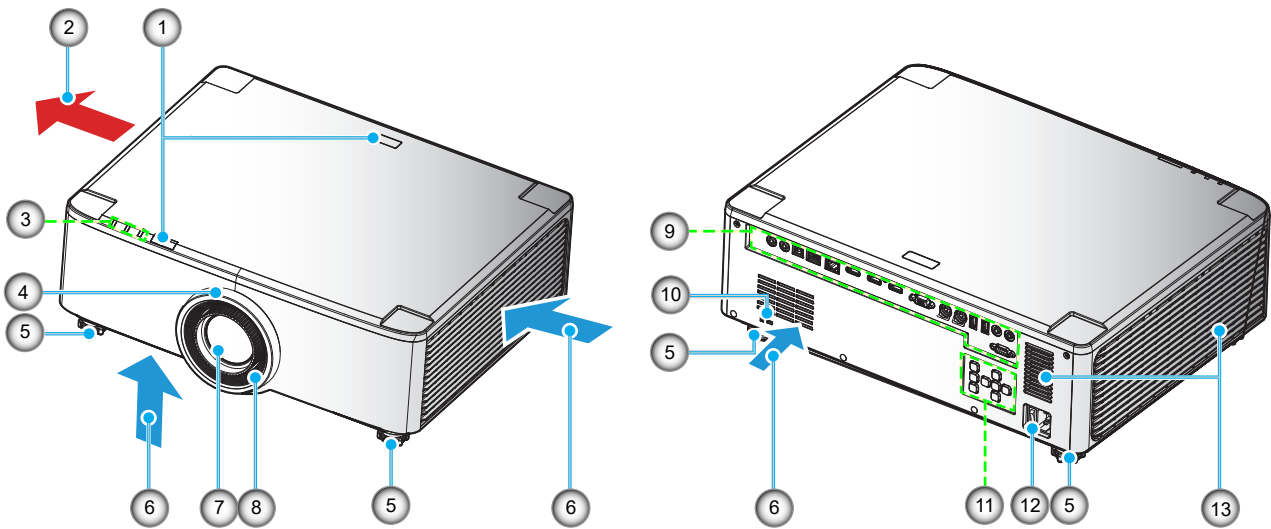

Note:

- Do not block projector intake and exhaust vents.
- When operating the projector in an enclosed space, allow at least 50cm (19") clearance around the intake and exhaust vents.
- The 1.25x lens/ Short Throw lens models does not have a focus ring.

No.	Item	No.	Item
1.	IR Receiver	8.	Focus Ring (1.8x lens model)
2.	Ventilation (Outlet)	9.	Input / Output
3.	LED Indicators	10.	Kensington™ Lock Port
4.	Zoom Ring (1.8x lens model) Deco Ring (1.25x lens/ Short Throw lens models)	11.	Control Panel
5.	Tilt-Adjustment Foot	12.	Power Socket / Power Switch
6.	Ventilation (Inlet)	13.	Speakers
7.	Projection Lens		

INTRODUCTION

Connections

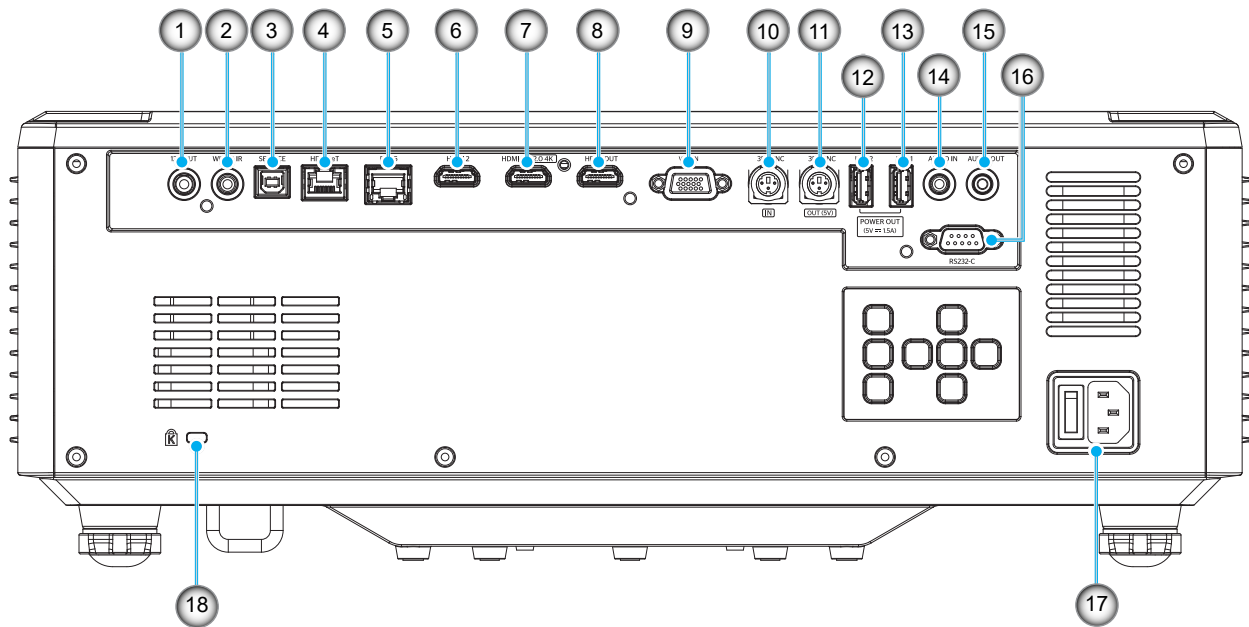

No.	Item	No.	Item
1.	12V OUT Connector	10.	3D SYNC IN Connector
2.	Wired IR Connector	11.	3D SYNC OUT Connector
3.	Service Connector (for firmware upgrade only)	12.	USB 2 Connector (Power 5V---1.5A)(*)
4.	HDBaseT Connector	13.	USB 1 Connector (Power 5V---1.5A)(*)
5.	RJ-45 Connector	14.	Audio IN Connector
6.	HDMI 2 Connector	15.	Audio OUT Connector
7.	HDMI 1 Connector (HDMI v2.0 4K)	16.	RS232 Connector
8.	HDMI OUT Connector(**)	17.	Power Socket / Power Switch
9.	VGA-IN Connector	18.	Kensington™ Lock Port

Note: (*) Not recommended for charging a cell phone.

(**) HDMI Out loop through HDMI1 only.

INTRODUCTION

Keypad and LED Indicators

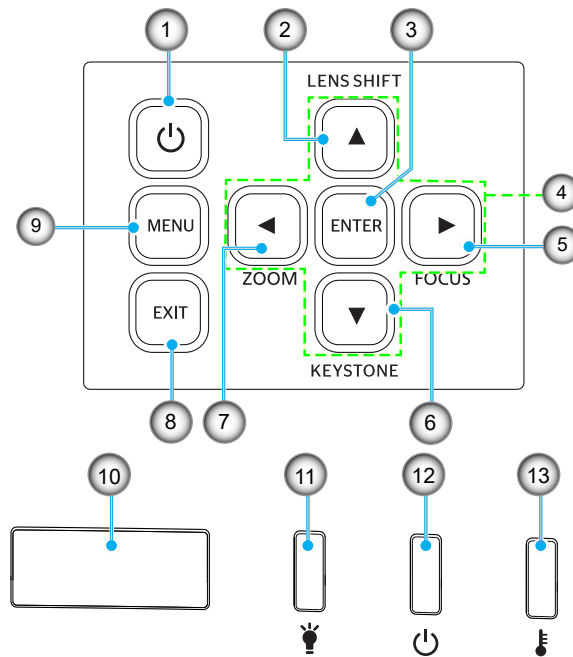

No.	Item	No.	Item
1.	Power Button	8.	Exit
2.	Lens Shift	9.	Menu
3.	Enter	10.	IR Receiver
4.	Four Directional Select Keys	11.	Light LED
5.	Focus (support 1.25x lens/ Short Throw lens models)	12.	Power LED
6.	Keystone Correction	13.	Temp LED
7.	Zoom (support 1.25x lens/ Short Throw lens models)		



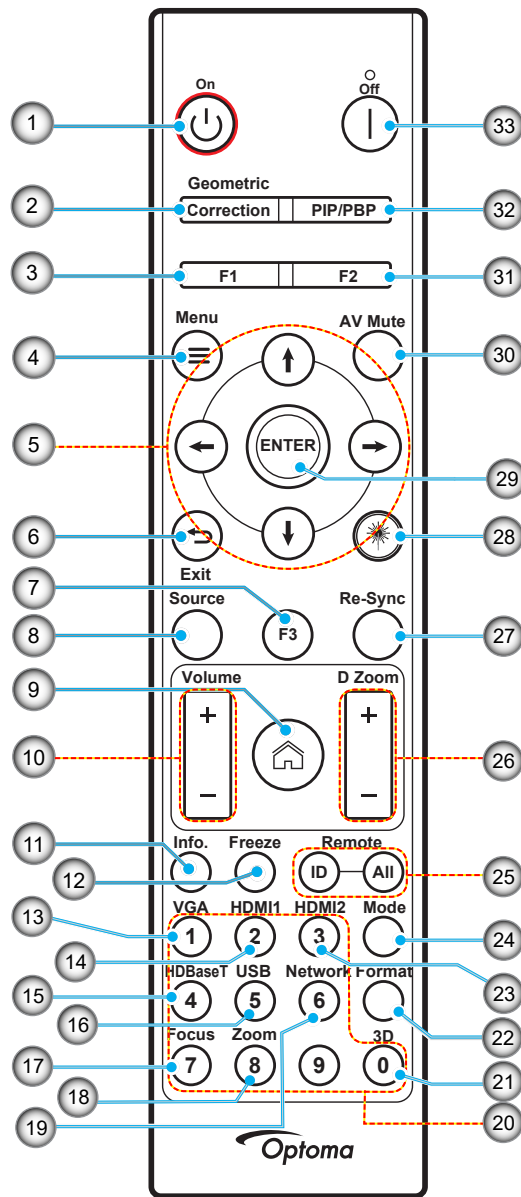

INTRODUCTION

Remote Control



No	Item	Item
1.	Power On	Refer to the “Powering On / Off the Projector” section on page 25-27.
2.	Geometric Correction	Press “Geometric Correction” to launch the Geometric Correction menu. H. Keystone/ V. Keystone / 4 corner / Reset, use the four directional select keys.
3.	Function Button (F1) (Assignable)	Press “F1” to activate a function.
4.	Menu	Press “” to launch the on-screen display (OSD) menu.
5.	Four Directional Select Keys	Use to select items or make adjustments to your selection.
6.	Exit	Exit the current page and return to the previous page.
7.	Function Button (F3) (Assignable)	Press “F3” to activate a function.
8.	Source	Press “Source” to select an input signal.

INTRODUCTION

No	Item	Item
9.	Home 	Press “  ” to switch to the launcher home.
10.	Volume +/-	Adjust to increase / decrease the volume.
11.	Information	Display the projector information.
12.	Freeze	Pause the screen image. Press again to resume the screen image.
13.	VGA	Press “VGA” to switch to the VGA IN source.
14.	HDMI1	Press “HDMI1” to switch to the HDMI 1 source.
15.	HDBaseT	Press “HDBaseT” to switch to the HDBaseT source.
16.	USB	Press “USB” to switch to the USB source.
17.	Focus	Press “Focus” and ← or → buttons on the remote control to focus the projected image (Support 1.25x /ST models only).
18.	Zoom	Press “Zoom” and ← or → buttons on the remote control to zoom the projected image size (image (Support 1.25x /ST models only).
19.	Network	Press “Network” to configure network settings.
20.	Numeric Keypad (0~9)	Use as numeric keypad number “0~9”.
21.	3D	Press “3D” to switch to the 3D source.
22.	Format	Press “Format” to set different aspect ratio.
23.	HDMI2	Press “HDMI2” to switch to the HDMI 2 source.
24.	Mode	Press “Mode” to select the display mode.
25.	Remote ID / Remote All	Press and Hold Remote ID key for 3 Sec into ID setting mode, than enter numeric keypad to set Remote ID.
26.	Digital Zoom +/-	Zoom in/out the projected image.
27.	Re-Sync	Automatically synchronize the projector to the input source.
28.	Laser 	Point the remote control at the screen, press and hold the “laser” key to activate the laser light.  WARNING: Do not look at the laser when it is active. Avoid pointing the laser at your eyes.
29.	Enter	Confirm your item selection.
30.	AV Mute	Press “AV Mute” to momentarily turn off/on the audio and video.
31.	Function Button (F2) (Assignable)	Press “F2” to activate a function.
32.	PIP/PBP Menu	Press “PIP/PBP” to launch PIP/PBP menu.
33.	Power Off	Refer to the “Powering On / Off the Projector” section on page 25-27.

Note: Some keys may have no function for models that do not support these features.

SETUP AND INSTALLATION

Connecting Sources to the Projector

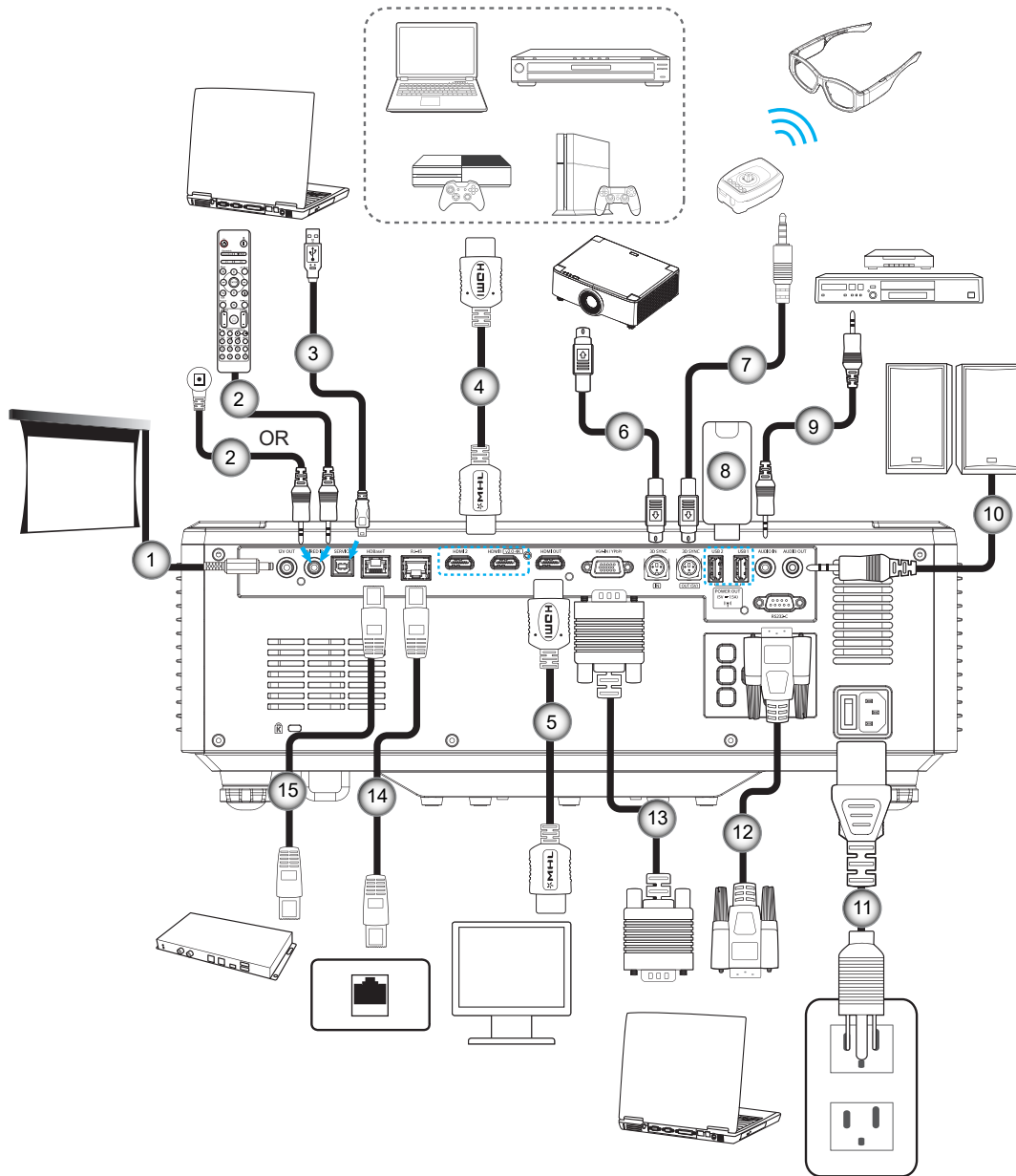

No.	Item
1.	12V DC Jack
2.	Wired Remote Control Cable or IR Receiver Cable
3.	USB (A to B) Cable (Service only)
4.	HDMI Cable
5.	HDMI Cable

No.	Item
6.	Mini Din 3-pin Cable
7.	Mini Din 3-pin Cable
8.	USB Flash Drive
9.	Audio In Cable
10.	Audio Out Cable

No.	Item
11.	Power Cord
12.	RS232 Cable
13.	VGA Cable
14.	RJ-45 Cable
15.	RJ-45 Cable

SETUP AND INSTALLATION

Adjusting the Projector Image

Adjusting the Projector's Height

The projector is equipped with elevator feet for adjusting the image height.

1. Locate the adjustable foot you wish to adjust on the underside of the projector.
2. Rotate the adjustable foot clockwise or counterclockwise to raise or lower the projector.

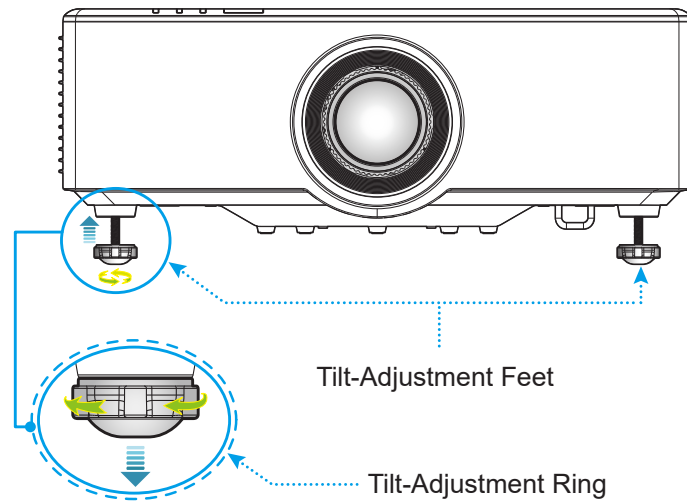

SETUP AND INSTALLATION

Adjusting the Projection Image Shift

The projection lens can be moved up, down, right, and left with the motor-driven lens shift function. This function makes the positioning of images easy on the screen. Lens shift is generally expressed as a percentage of the image height or width, see below illustration.

Vertical / Horizontal Lens Shift

When the lens is shifted to top:

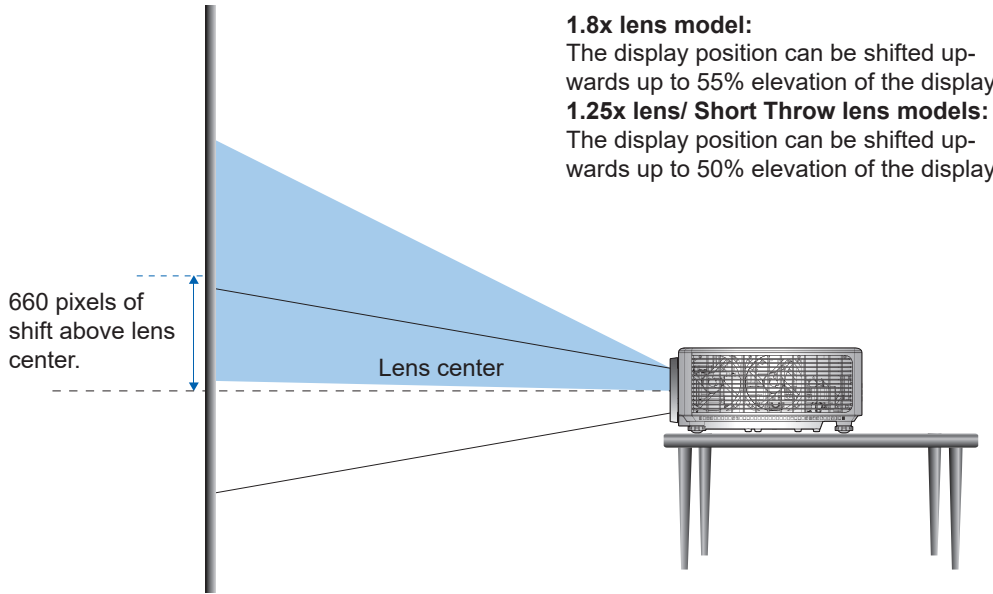

When the lens is shifted to bottom:

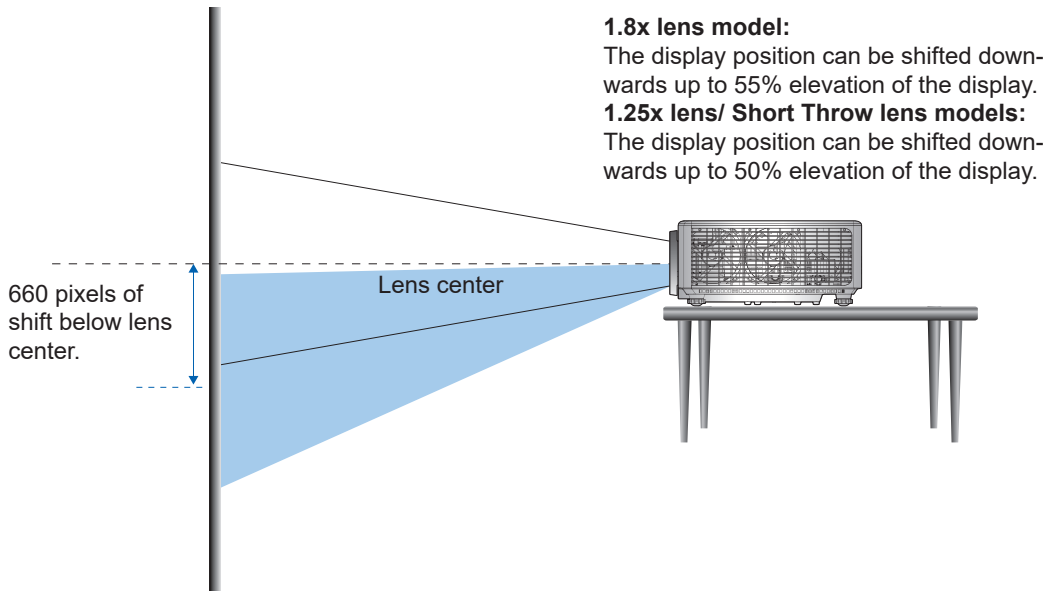

SETUP AND INSTALLATION

When the lens is shifted to the leftmost:

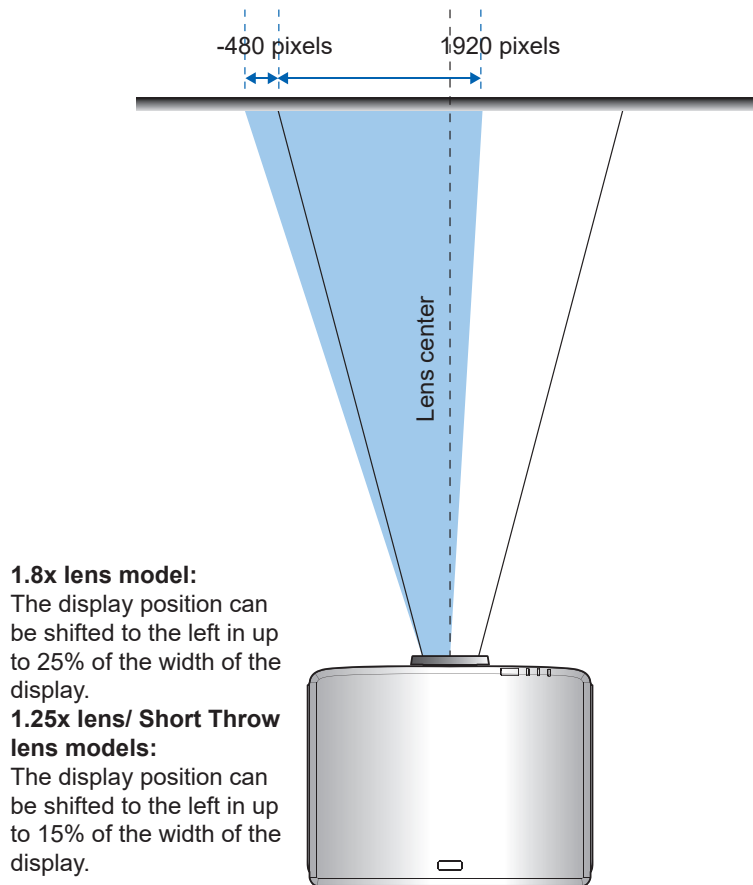

When the lens is shifted to the rightmost:

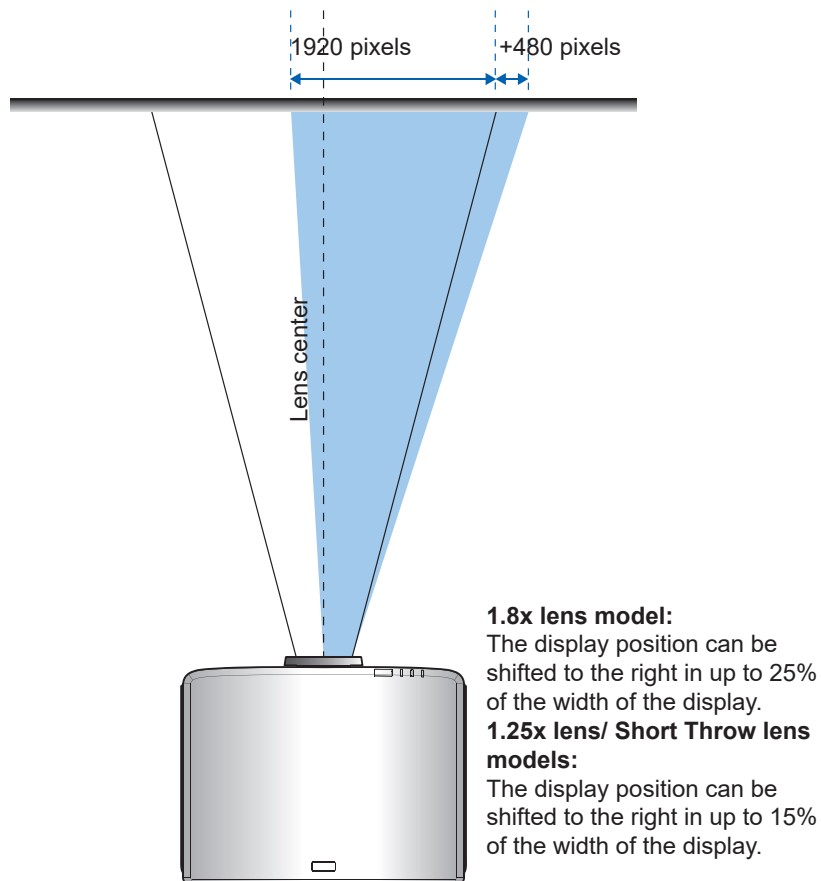

SETUP AND INSTALLATION

Lens Shift Range

WUXGA	Lens Shift Range			
	ΔH	ΔV	ΔHo	ΔVo
1.8x lens model	25%	55%	4%	12%
1.25x lens model	15%	50%	0%	20%
Short Throw model	15%	50%	0%	20%

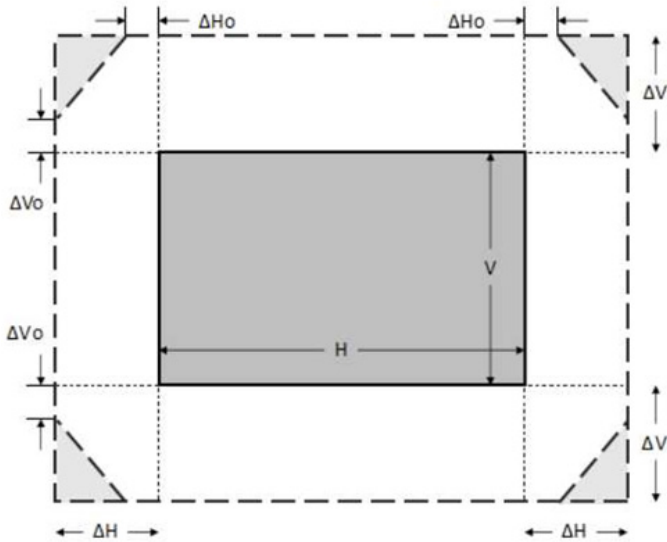

Note:

- ΔH : The lens shift range in horizontal direction when the lens is at the center.
- ΔV : The lens shift range in vertical direction when the lens is at the center.
- ΔHo : The lens shift range without vignetting in horizontal direction when the lens is at the top center or the bottom center.
- ΔVo : The lens shift range without vignetting in vertical direction when the lens is at the middle right or the middle left.

SETUP AND INSTALLATION

Adjusting the Projector's Zoom and Focus

For 1.8x lens model:

- To adjust the focus, manually turn the focus ring clockwise or counterclockwise until the image is sharp and legible. The projector focuses at distances ranging between 46.1 to 648.4 inches (1.17 m to 16.47 m).
- To adjust the image size, manually turn the zoom lever clockwise or counterclockwise to increase or decrease the projected image size.

For 1.25x lens/ Short Throw lens models:

- To adjust the focus and image size is by motorized, please use remote or keypad to zoom ring to zoom in and out, and control the focus ring until the image is sharp and legible.
- The 1.25x lens models projector focuses at distances ranging between 51.1 to 386.6 inches (1.30 m to 9.96 m).
- The Short Throw lens models projector focuses at distances ranging between 31.2 to 244.7 inches (0.79 m to 6.21 m).

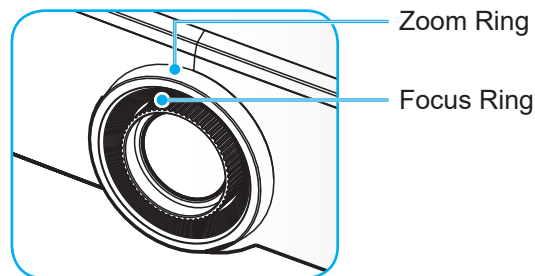

Note: The 1.25x lens/ Short Throw lens models does not have a focus ring.

SETUP AND INSTALLATION

Adjusting the Projector Position

When you select a position for the projector, consider the size and shape of your screen, the location of your power outlets, and the distance between the projector and the rest of your equipment.

Follow these general guidelines:

- Position the projector on a flat surface at a right angle to the screen. The 1.8x lens model projector (with the standard lens) must be at least 40 inch (1.02m) from the projection screen. The 1.25x lens/ Short Throw lens models projector (with the standard lens) must be at least 50 inch (1.27m) from the projection screen.
- Position the projector to the desired distance from the screen. The distance from the lens of the projector to the screen, the zoom setting, and the video format determine the size of the projected image.
- Lens throw ratio:
1.8x lens model: 1.44 ~ 2.59
1.25x lens model: 1.22 ~ 1.52
Short Throw model: 0.75 ~ 0.95
- 360 degrees free orientation operation.

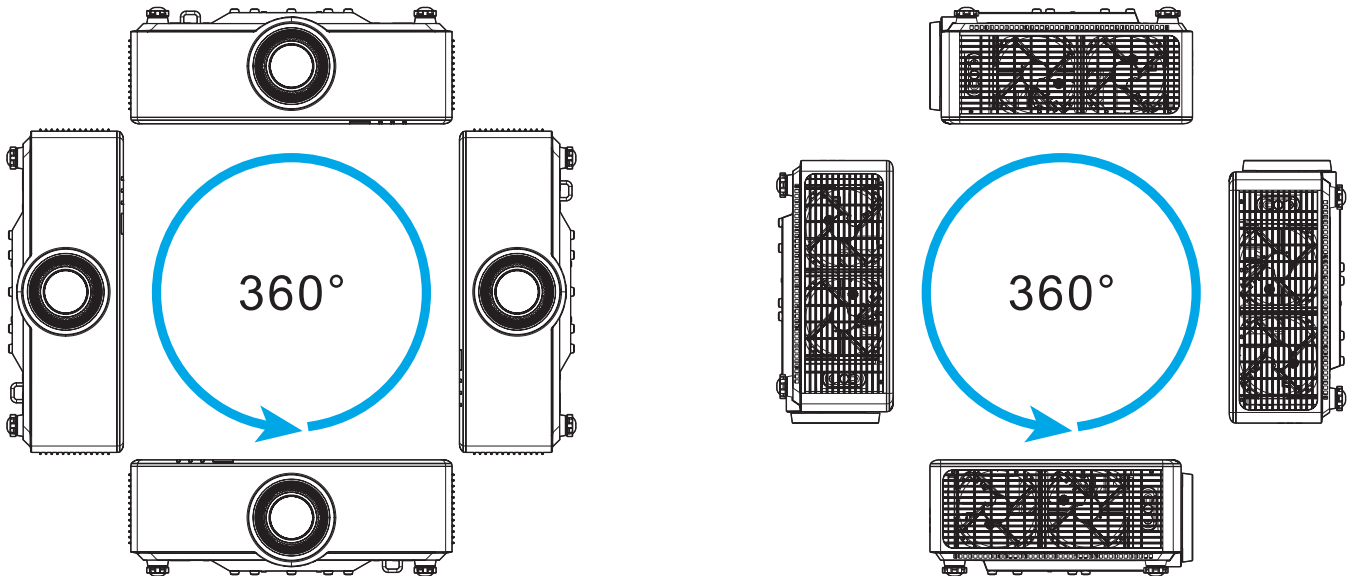

- When installing multiple projectors, keep at least 1m space between the adjacent projectors.
- For ceiling/wall mount installations, make sure to leave 15 mm (0.6") between the ceiling mount and the bottom intake vents of the projector.

SETUP AND INSTALLATION

Remote Setup

Install / Replacing Remote Control Batteries

Two AAA size batteries are supplied for the remote control.

1. Remove the battery cover on the back of the remote control.
2. Insert AAA batteries in the battery compartment as illustrated.
3. Replace back cover on remote control.

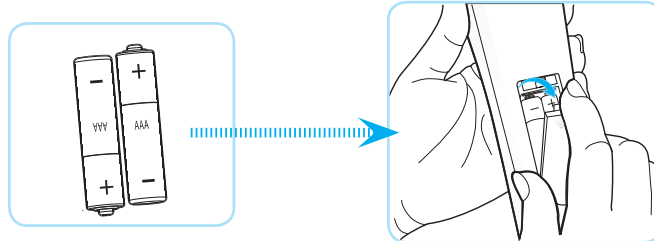

Note: Replace only with the same or equivalent type batteries.

CAUTION

Improper use of batteries can result in chemical leakage or explosion. Be sure to follow the instructions below.

- Do not mix batteries of different types. Different types of batteries have different characteristics.
- Do not mix old and new batteries. Mixing old and new batteries can shorten the life of new batteries or cause chemical leakage in old batteries.
- Remove batteries as soon as they are depleted. Chemicals that leak from batteries that come in contact with skin can cause a rash. If you find any chemical leakage, wipe thoroughly with a cloth.
- The batteries supplied with this product may have a shorter life expectancy due to storage conditions.
- If you will not be using the remote control for an extended period of time, remove the batteries.
- When you dispose of the batteries, you must obey the law in the relative area or country.

SETUP AND INSTALLATION

Remote Control Effective Range

Infra-Red (IR) remote control sensor is located on the top and front sides of the projector. Ensure to hold the remote control at an angle within 30 degrees perpendicular to the projector's IR remote control sensor to function correctly. The distance between the remote control and the sensor should not be longer than 6 meters (19.7 feet) when holding in an angle $\pm 15^\circ$ and not longer than 8 meters (26.2 feet) when aiming the sensor at 0° .

- Make sure that there are no obstacles between the remote control and the IR sensor on the projector that might obstruct the infra-red beam.
- Make sure the IR transmitter of the remote control is not being shined by sunlight or fluorescent lamps directly.
- Please keep the remote controller away from fluorescent lamps for over 2 m or the remote controller might become malfunction.
- If the remote control is close to Inverter-Type fluorescent lamps, it might become ineffective from time to time.
- If the remote control and the projector are within a very short distance, the remote control might become ineffective.
- When you aim at the screen, the effective distance is less than 5 m from the remote control to the screen and reflecting the IR beams back to the projector. However, the effective range might change according to screens.

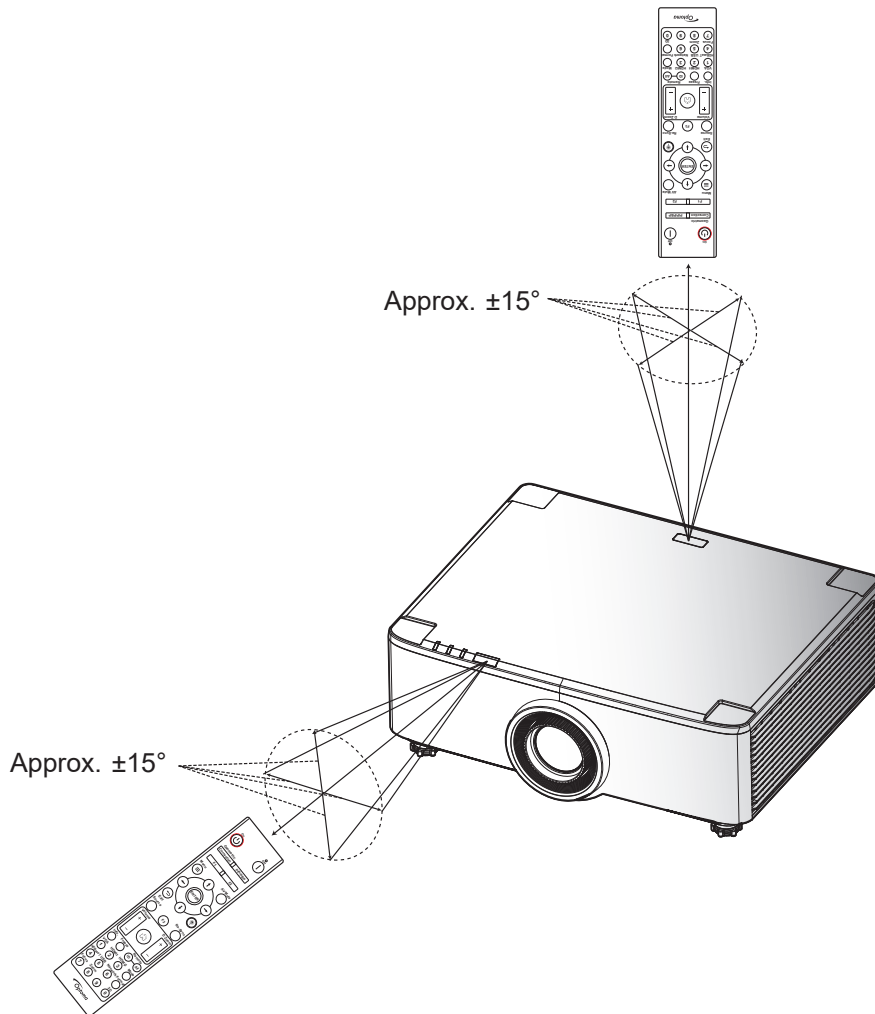

USING THE PROJECTOR

Powering On / Off the Projector

Powering On

1. Securely connect the power lead and signal/source cable. When connected, the power LED will turn red.
2. Set the power switch to the “I” (On) position and wait until the “⏻” button on the projector keypad is solid red.

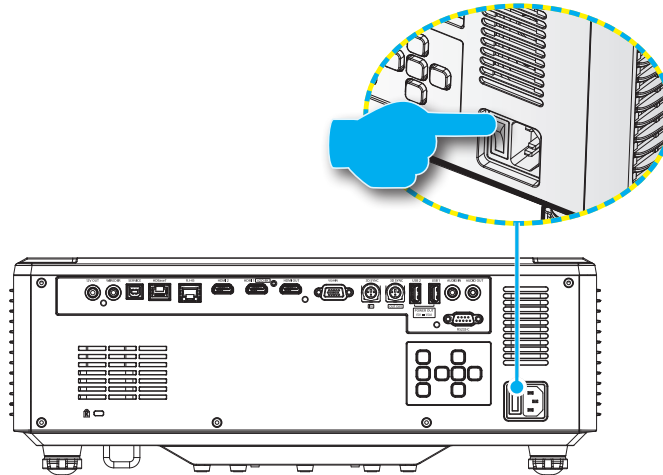

3. Turn on the projector by pressing the “⏻” button on the projector keypad or remote control. During startup the power LED is flashing red and during normal operation, the power LED is solid green.

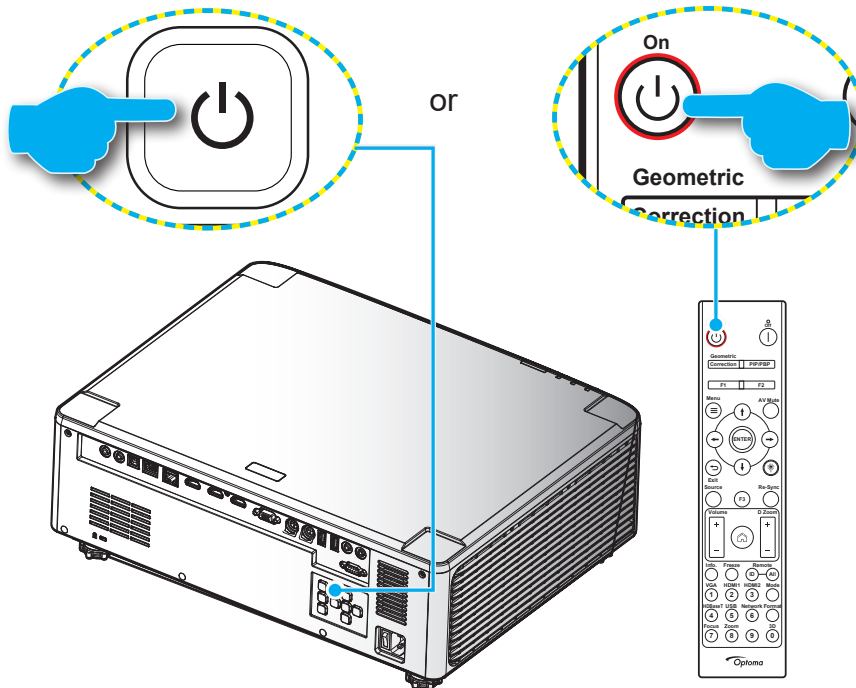

USING THE PROJECTOR

The first time the projector is turned on, you will be prompted to complete the initial setup including selecting the projection orientation, preferred language, and more. Once the **Setup Complete!** screen appears, it indicates the projector is ready to use.

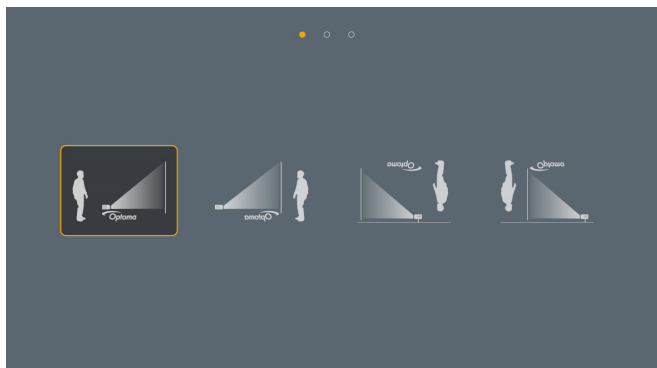

[Projection screen]

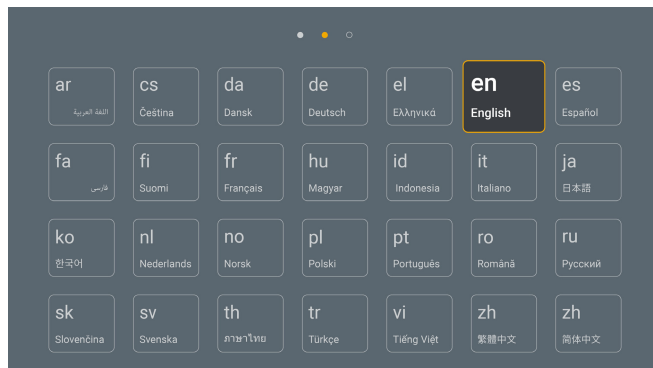

[Language screen]

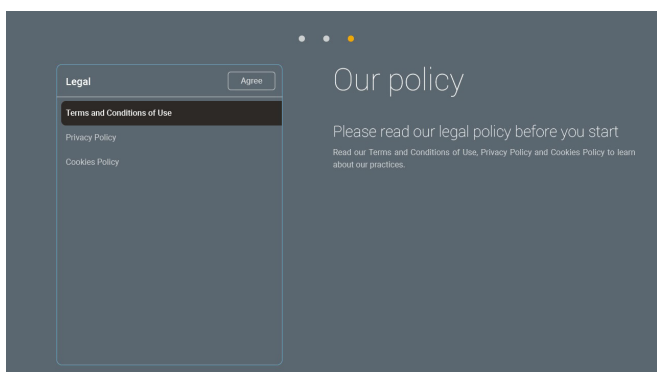

[Regulation screen]

USING THE PROJECTOR

Powering Off

1. Turn off the projector by pressing the “⏻” button on the projector keypad or the | button on the remote control. The following message will be displayed:



2. Press the ⏻ or | button again to confirm, otherwise the message will disappear after 15 seconds. When you press the ⏻ or | button for the second time, the projector will shut down.
3. During the cooling cycle, the power LED is flashing green. When the power LED turns solid red, this indicates the projector has entered standby mode. If you wish to turn the projector back on, you must wait until the cooling cycle has finished and the projector has entered standby mode. When the projector is in standby mode, simply press the “⏻” button on the projector or the remote control again to turn on the projector.
4. Disconnect the power cord from the electrical outlet and the projector.

Note:

- *It is not recommended that the projector is turned on immediately, right after a power off procedure.*
- *By default, the projector turns off automatically after 20 minutes of inactivity. You can modify the idle time length in “Auto Power off (min.)” menu in “System Settings → Power”. If you want the projector to enter standby mode instead, disable auto power off and set the sleep time interval in “System Settings → Power → Sleep Timer (min.)”.*

USING THE PROJECTOR

Home Screen Overview

The Home screen is displayed every time you start the projector. It contains system date and time, system status, icons to access OSD menu, projector settings menu, apps, input sources, and more.

To navigate the Home screen, simply use the buttons on the remote control.

You can return to the Home screen at any time by pressing “” on the remote control, regardless of your position in the user interface.

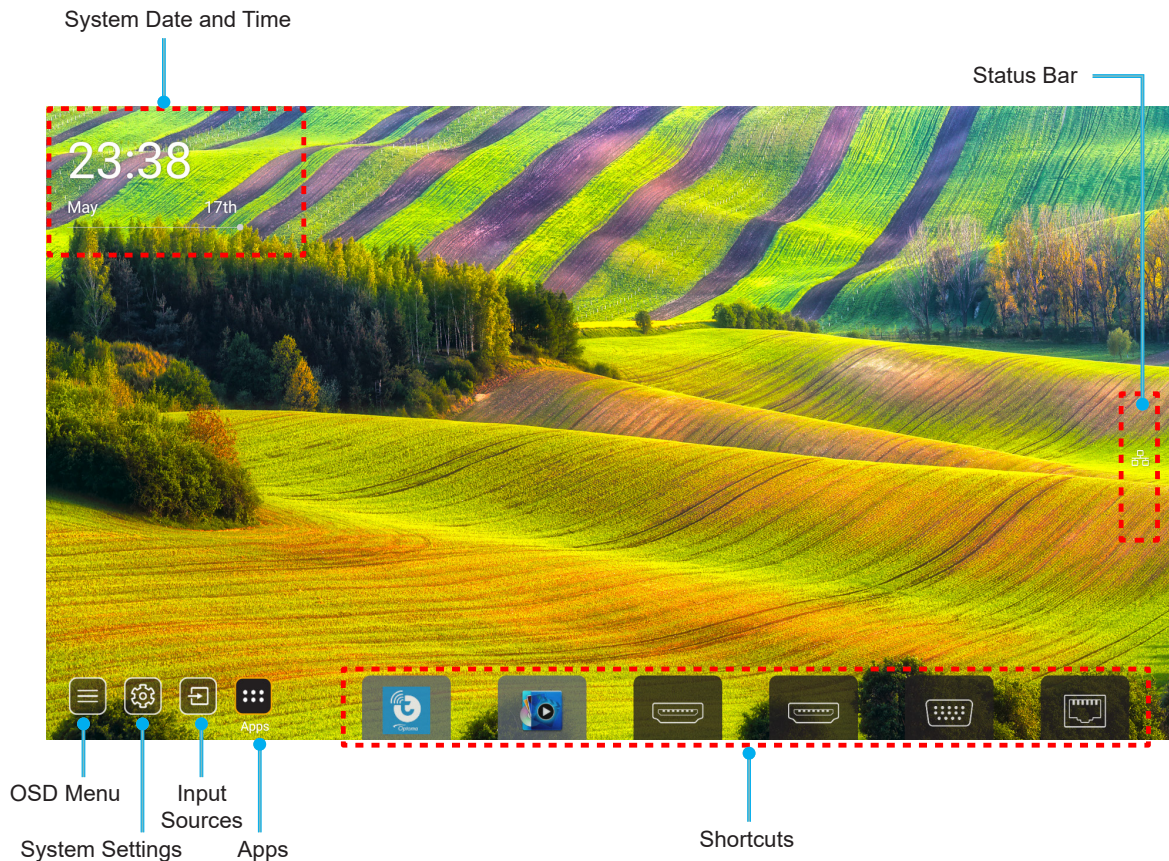

Note: The selected menu or item is highlighted in orange color, for example “Apps” on the image above.

Note: You can personalize shortcut settings in “System Settings menu  → Personalize → Home Shortcut”. You can also modify the shortcut order on the Home screen.

System Date and Time

Date and time is displayed on the Home screen if the projector is connected to the network. The default setting is 10:00am, 2019/01/01. AM/PM will appear only if the 24-hour format is off.

To modify date and time parameters, select the respective field on the screen. The Date and Time settings page opens automatically. Then perform the modifications.

USING THE PROJECTOR

Projector Settings Menu (OSD)

Press “≡” on the remote control or on the Home screen, select the OSD menu “⊞” to review projector information or manage various settings related to the image, display, 3D, audio, and setup.

General Menu Navigation

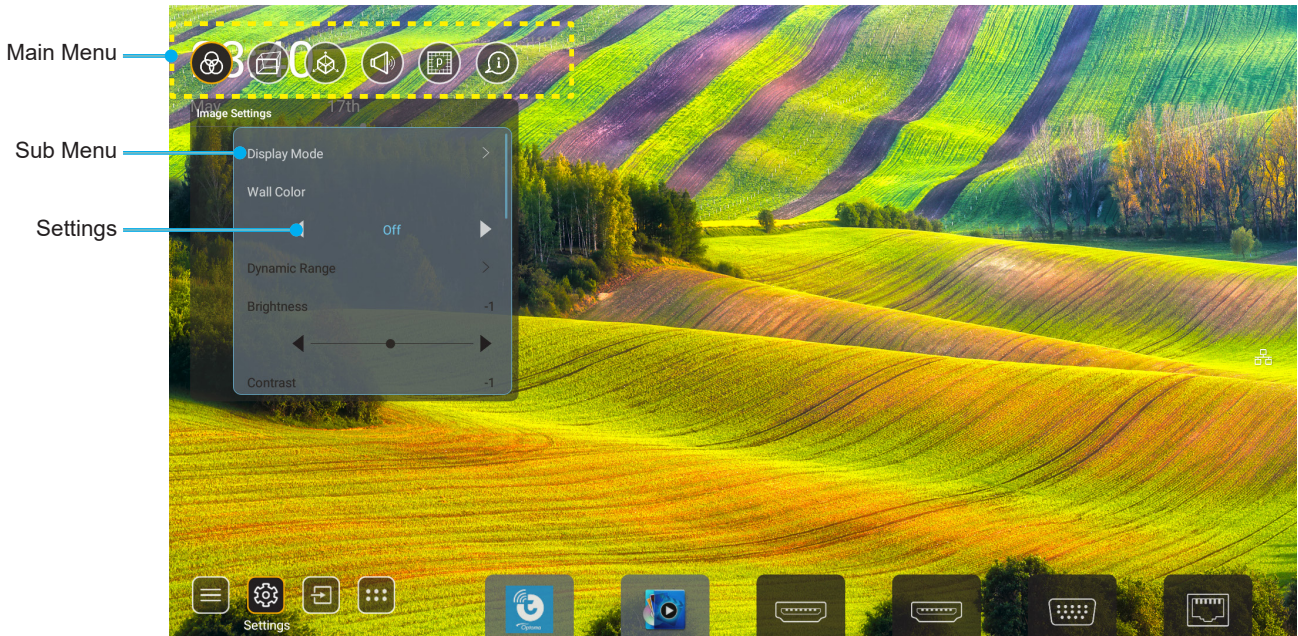

1. When OSD is displayed, use the up and down navigation buttons to select any item in the main menu. While making a selection on a particular page, press “OK” to enter submenu.
2. Press the “Left” and “Right” button to select the desired menu item. Then press “OK” to open its sub menu.
3. Press the “Up” and “Down” button to select the desired item in the sub menu.
4. Press the “OK” button to enable or disable a setting or press the “Left” and “Right” button to adjust a value.
5. Select the next item to be adjusted in the sub menu and modify as described above.
6. To exit, press “←” (repeatedly if necessary). The OSD menu will close and the projector will automatically save the new settings.

USING THE PROJECTOR

OSD Menu tree

Note: The OSD menu appears in the same language as the system. If needed, change the language in the System Settings menu.

Level 1	Level 2	Level 3	Level 4	Value
Image Settings	Display Mode			Presentation
				Bright
				HDR
				Cinema
				sRGB
				DICOM SIM.
				Blending
				User
				3D
	Wall Color			Off
				Blackboard
				Light Yellow
				Light Green
				Light Blue
				Pink
				Gray
	Dynamic Range	HDR		Auto [Default]
				Off
		HDR Picture Mode		Bright
				Standard [Default]
				Film
			Detail	
	Brightness			-50 ~ +50
	Contrast			-50 ~ +50
	Sharpness			1 ~ 15
	Color			-50 ~ +50
	Tint			-50 ~ +50
	Gamma		Film	
			Video	
			Graphics	
			Standard(2.2)	
			1.8	
			2.0	
		2.4		
	2.6			
Color Settings		BrilliantColor™		1 ~ 10
	Color Temperature			Standard
				Cool
				Cold











USING THE PROJECTOR

Level 1	Level 2	Level 3	Level 4	Value
Image Settings	Color Settings	Color Matching	Color	R [Default]
				G
				B
				C
				Y
				M
				W
		Hue	0 ~ 199	
		Saturation	0 ~ 199	
		Gain	0 ~ 199	
		Reset	Cancel [Default]	
			Yes	
		RGB Gain/Bias	Red Gain	0 ~ 100
			Green Gain	0 ~ 100
	Blue Gain		0 ~ 100	
	Red Bias		0 ~ 100	
	Green Bias		0 ~ 100	
	Blue Bias		0 ~ 100	
	Reset		Cancel [Default]	
		Yes		
	Dynamic Black		Off [Default]	
			On	
	Extreme Black		Off [Default]	
		On		
	Constant Power	100% [Default], 80%, 65%, 50%		
	Constant Luminance	Off [Default]		
		85%, 80%, 75%, 70%		
Reset		Cancel [Default]		
		Yes		
Display	Aspect Ratio		Auto	
			4:3	
			16:9	
			16:10	
	Edge Mask		0 ~ 10 [Default: 0]	
	Digital Zoom	Zoom	-5 ~ +25 [Default: 0]	
		Reset	No [Default]	
			Yes	
Image Shift		(Image Shift for adjust)		











USING THE PROJECTOR

Level 1	Level 2	Level 3	Level 4	Value	
Display	Geometric Correction	Four Corner Control		Off	
				On [Default]	
		Four Corner Adjustment		(Pattern for adjust)	
		H Keystone		-40 ~ +40 [Default: 0]	
		V Keystone		-40 ~ +40 [Default: 0]	
		Warp/Blend Control		Off [Default]	
				OSD	
		Warp/Blend Memory	Apply	1 ~ 5 [Default: 1]	
			Save Current	1 ~ 5 [Default: 1]	
		Warp/Blend Cursor Color		Green	
				Magenta [Default]	
				Red	
				Cyan	
		Warp/Blend Grid Color		Green [Default]	
				Magenta	
				Red	
				Cyan	
		Warp/Blend Background Color		None	
				Black [Default]	
		Warp Setting	Warp Calibration		(Pattern for adjust)
					2x2 [Default]
			Grid Points		3x3
					5x5
					9x9
					17x17
		Warp Inner	Off [Default]		
			On		
		Warp Sharpness	0 ~ 9 [Default: 9]		
		Blend Setting	Blend Width		(Pattern for adjust)
					4 [Default]
			Overlap Grid Number		6
					8
					10
					12
			Blend Gamma		1.8
					2.0
					2.2 [Default]
				2.4	
				2.6	
		Reset		Cancel [Default]	
	Yes				





USING THE PROJECTOR

Level 1	Level 2	Level 3	Level 4	Value	
Display	Signal	Automatic		Off [Default]	
				On	
		Frequency		-50 ~ +50 (depend on signal)	
		Phase		0 ~ 31 (depend on signal)	
		H. Position		-30 ~ +10 (depend on signal)	
	V. Position		-10 ~ +10 (depend on signal)		
	PIP/PBP	Screen			None
					PIP 
					PBP 
		PIP Location			
					
					
					
		PBP Location			
					
					
					
		Size			Large
					Medium
					Small
		Main Source			HDMI 1
					HDMI 2
					VGA
					HDBaseT
					USB
					Home
		Sub Source			HDMI 1
					HDMI 2
					VGA
					HDBaseT
				USB	
				Home	

USING THE PROJECTOR

Level 1	Level 2	Level 3	Level 4	Value
Display	PIP/PBP	Swap		Off [Default]
				On
	Menu Setting	Menu Location		 [Default]
				
				
				
				
	Menu Timer		Off	
			5sec	
		10sec [Default]		
3D	3D Mode		Off [Default]	
			On	
	3D Tech.		DLP-Link [Default]	
			3D Sync	
	3D Format		Auto [Default] 	
			SBS 	
			Top and Bottom 	
			Frame Sequential 	
			Frame Packing 	
	3D Sync Invert		Off [Default]	
			On	
	3D Sync Out		To Emitter [Default]	
			To Next Projector	
	L/R Reference		Field GPIO	
			1ST Frame [Default]	
3D Frame Delay		0 ~ 200		
Reset		Cancel [Default]		
		Yes		
Audio	Mute		Off [Default]	
			On	
	Volume		0 ~ 100 [Default: 50]	

USING THE PROJECTOR

Level 1	Level 2	Level 3	Level 4	Value	
Setup	Projection Mode			 [Default]	
					
					
					
	Screen Type				4:3
					16:9
					16:10 [Default]
	Filter Settings	Filter Usage Hours			"Read Only [Range 0 ~ 99999]"
		Optional Filter Installed			No [Default]
					Yes
		Filter Reminder			Off
					300hr
					500hr [Default]
					800hr
		Filter Reset			1000hr
				Cancel [Default]	
	Lens Settings				Yes
		Zoom (1.25x lens/ Short Throw lens models only)			(Zoom for adjust)
		Focus (1.25x lens/ Short Throw lens models only)			(Focus for adjust)
		Lens Function			Unlock [Default]
					Lock
		Lens Shift			(Pattern for adjust)
		Lens Calibration			(Lens calibration for adjust)
		Lens Memory	Apply Position		
	Save Current Position				1 ~ 5
	Reset				Cancel [Default]
				Yes	
	Test Pattern				Green Grid
					Magenta Grid
					White Grid
					White
					Off
	High Altitude				Off [Default]
				On	
Display Mode Lock				Off [Default]	
				On	
Keypad Lock				Off [Default]	
				On	

USING THE PROJECTOR

Level 1	Level 2	Level 3	Level 4	Value
Information	Display	Display Mode		
		Brightness Mode	Constant Power	
	Hardware	Power Mode (Standby)		
		High Altitude		
		Filter Usage Hours		Read Only [Range 0~99999 hr]
		Projection Hours		Read Only [Range 0~99999 hr]
		System Temperature		Read Only
	Input Source	Main Source	Source	
			Resolution	
			Refresh Rate	
			Color Depth	
		Sub Source	Source	
			Resolution	
			Refresh Rate	
			Color Depth	
	Network	LAN Control	LAN Status	
			IP Address	
			Subnet Mask	
			Gateway	
			DNS	
			MAC Address	
	About	Regulatory		
		Serial Number		
		FW Version	System	
			LAN	
			MCU	
	DDP			
Control	Projector ID		0~99	
	Remote Code		0~99	

USING THE PROJECTOR

Image Settings Menu

Display Mode

There are many factory presets optimized for various types of images.

- **Presentation:** This mode is suitable for showing in front of public in connection to the PC.
- **Bright:** Maximum brightness from PC input.
- **HDR:** Decodes and displays High Dynamic Range (HDR) content for the deepest blacks, brightest whites, and vivid cinematic color using REC.2020 color gamut. This mode will be automatically enabled if HDR is set to ON (and HDR Content is sent to projector – 4K UHD Blu-ray, 1080p/4K UHD HDR Games, 4K UHD Streaming Video). While HDR mode is active, other display modes (Cinema, Reference, etc.) cannot be selected as HDR delivers color that is highly accurate, exceeding the color performance of the other display modes.
- **Cinema:** Provides the best colors for watching movies.
- **sRGB:** Standardized accurate color.
- **DICOM SIM.:** This mode can project a monochrome medical image such as an X ray radiography, MRI, etc.
- **Blending:** When using multiple projectors, this mode can eliminate the visible banding and create a single bright, high resolution image across the screen.
- **User:** Memorize user's settings.
- **3D:** To experience the 3D effect, you need to have 3D glasses. Make sure a Blu-ray 3D DVD player is installed.

Note:

- *The 3D mode is off by default.*
- *When the Display Mode Lock function is turned on, the Presentation, Bright, Cinema, sRGB, DICOM SIM., Blending, and User mode will be unavailable.*
- *When the 3D or HDR function is turned on, the Presentation, Bright, Cinema, sRGB, DICOM SIM., Blending, and User mode will be unavailable.*

Wall Color

Use this function to obtain an optimized screen image according to the wall color. Select between off, blackboard, light yellow, light green, light blue, pink, and gray.

Note: *When the Display Mode Lock or 3D function is turned on, the Wall Color will be unavailable.*

Dynamic Range

Configure the High Dynamic Range (HDR) setting and its effect when displaying video from 4K HDR Blu-ray players, 1080p HDR and 4K HDR Game Consoles, 4K HDR Streaming Set-top boxes and 4K HDR streaming services.

Note: *HDMI 2 and VGA source do not support Dynamic Range.*

➤ **HDR (High Dynamic Range)**

- **Auto:** Auto detect HDR signal.
- **Off:** Turn off HDR Processing. When set to Off, the projector will NOT decode HDR content.

➤ **HDR Picture Mode**

- **Bright:** Choose this mode for brighter more saturated colors.
- **Standard:** Choose this mode for natural looking colors with a balance of warm and cool tones.
- **Film:** Choose this mode for improved detail and image sharpness.
- **Detail:** Choose this mode for improved detail and image sharpness in dark scenes.

USING THE PROJECTOR

Brightness

Adjust the brightness of the image.

Note:

- *When the Display Mode Lock function is turned on, the Brightness will be unavailable.*
- *When the input source switch to Home, the Brightness will be unavailable.*

Contrast

The contrast controls the degree of difference between the lightest and darkest parts of the picture.

Note:

- *When the Display Mode Lock function is turned on, the Contrast will be unavailable.*
- *When the input source switch to Home, the Contrast will be unavailable.*

Sharpness

Adjust the sharpness of the image.

Color

Adjust a video image from black and white to fully saturated color.

Note: *When the input source VGA, HDMI 1, HDMI 2 and HDBaseT color formats are RGB, the Color will be unavailable.*

Tint

Adjust the color balance of red and green.

Note: *When the input source VGA, HDMI 1, HDMI 2 and HDBaseT color formats are RGB, the Tint will be unavailable.*

Gamma

Set up gamma curve type. After the initial setup and fine tuning is completed, utilize the Gamma Adjustment steps to optimize your image output.

- **Film:** For home theater.
- **Video:** For video or TV source.
- **Graphics:** For PC / Photo source.
- **Standard(2.2):** For standardized setting.
- **1.8/2.0/2.4/2.6:** For specific PC / Photo source.

Note:

- *These options are only available if the 3D mode function is disabled, the **Wall Color** setting is not set to **Blackboard**, and the **Display Mode** setting is not set to **DICOM SIM.** or **HDR.***
- *When **Display Mode** is **HDR, 3D, Blackboard** and **DICOM SIM.**, Gamma will be unavailable.*
- *When the **Display Mode Lock, DICOM SIM mode, Wall Color, 3D, or HDR** function is turned on, the Gamma will be unavailable.*

Color Settings

Configure the color settings.

- **BrilliantColor™:** This adjustable item utilizes a new color-processing algorithm and enhancements to enable higher brightness while providing true, more vibrant colors in picture.

Note: *When the Display Mode Lock, Blending mode, or 3D function is turned on, the BrilliantColor will be unavailable.*

USING THE PROJECTOR

- **Color Temperature:** Select a color temperature from Warm, Standard, Cool, or Cold.
Note: *When the Display Mode Lock, sRGB, Blending, User or 3D mode function is turned on, the Color Temperature will be unavailable.*
- **Color Matching:** Adjust hue, saturation, and gain for the R (red), G (green), B (blue), C (cyan), Y (yellow), M (magenta), or (W) white color.
Note:
 - *Select "Reset" to reset the Color Matching settings and/or select "Exit" to exit the Color Matching menu.*
 - *When the Display Mode Lock function is turned on, the Color Matching will be unavailable.*
- **RGB Gain/Bias:** This settings allows to configure the brightness (gain) and contrast (bias) of an image.
Note:
 - *Select "Reset" to reset the RGB Gain/Bias settings and/or select "Exit" to exit the RGB Gain/Bias menu.*
 - *When the Display Mode Lock function is turned on, the RGB Gain/Bias will be unavailable.*

Dynamic Black

Auto adjust the contrast ratio for video contents.

Note: *When the Display Mode Lock function is turned on, the Dynamic Black will be unavailable.*

Extreme Black

Auto increase contrast when a blank (black) image is displayed.

Note: *When the Display Mode Lock function is turned on, the Extreme Black will be unavailable.*

Brightness Mode

Select the brightness mode setting.

- **Constant Power:** Choose the constant power percentage for brightness mode.
- **Constant Luminance:** Choose the constant luminance percentage for brightness mode.
Note: *When the Display Mode Lock or Dynamic Black function is turned on, the Brightness Mode will be unavailable.*

Reset

Return the factory default settings for image settings.

Note: *When the Display Mode Lock function is turned on, the Reset will be unavailable.*

USING THE PROJECTOR

Display Menu

Aspect Ratio

Select the aspect ratio of the displayed image between the following options:

- **Auto:** Automatically select the appropriate display format.
- **4:3:** This format is for 4:3 input sources.
- **16:9:** This format is for 16:9 input sources, like HDTV and DVD enhanced for Wide screen TV.
- **16:10:** This format is for 16:10 input sources, like widescreen laptops.

Note: When the input source switch to Home, the Aspect Ratio will be unavailable.

4K UHD scaling table:

16 : 9 screen	480i/p	576i/p	720p	1080i/p	2160p
Auto	- If source is 4:3, the screen type will be scaled to 2880 x 2160. - If source is 16:9, the screen type will be scaled to 3840 x 2160. - If source is 15:9, the screen type will be scaled to 3600 x 2160. - If source is 16:10, the screen type will be scaled to 3456 x 2160.				
4x3	Scale to 2880 x 2160.				
16x9	Scale to 3840 x 2160.				
16x10	Scale to 3456 x 2160.				

Auto mapping rule:

	Input resolution		Auto/Scale	
	H-resolution	V-resolution	3840	2160
4:3	640	480	2880	2160
	800	600	2880	2160
	1024	768	2880	2160
	1280	1024	2880	2160
	1400	1050	2880	2160
	1600	1200	2880	2160
Wide Laptop	1280	720	3840	2160
	1280	768	3600	2160
	1280	800	3456	2160
SDTV	720	576	2700	2160
	720	480	3240	2160
HDTV	1280	720	3840	2160
	1920	1080	3840	2160

Edge Mask

Use this function to remove the video encoding noise on the edge of video source.

Note: When the input source switch to USB or Home, the Edge Mask will be unavailable.

Digital Zoom

Adjust the image size on the projection screen.

USING THE PROJECTOR

Note: When the input source switch to USB or Home, the Digital Zoom will be unavailable.

Image Shift

Adjust the projected image position horizontally (H) or vertically (V).

Note: When the input source switch to USB or Home, the Image Shift will be unavailable.

Geometric Correction

Adjust the image's projection to match a specific projection surface or shape.

- **Four Corner Control:** Allows you to adjust the four corner controls.
- **Four Corner Adjustment:** Allow the image to be squeezed to fit an area defined by moving each of the four corners' x and y position.
Note: When the Four Corner Control function is turned off, the Four Corner Adjustment will be unavailable.
- **H Keystone:** Adjust image distortion horizontally and make a squarer image. Horizontal keystone is used to correct a keystone image shape in which the left and right borders of the image are unequal in length. This is intended for use with horizontally on-axis applications.
- **V Keystone:** Adjust image distortion vertically and make a squarer image. Vertical keystone is used to correct a keystone image shape in which the top and bottom are slanted to one of the sides. This is intended when for use with vertically on-axis applications.
- **Warp/Blend Control:** Set to "OSD" to use warp/blend settings to customize the projection image or set to "Off" to project native projection image.
- **Warp/Blend Memory:** Save the warp/blend data after warp/blend settings. Apply warp/blend data to the chosen set of warp/blend memory. The warp/blend memory can save up to five settings data.
- **Warp/Blend Cursor Color:** Allow you to select the Warp/Blend cursor color. Options include: Green, Magenta (default), Red, and Cyan.
- **Warp/Blend Grid Color:** Allow you to select the Warp/Blend grid color. Options include: Green (default), Magenta, Red, and Cyan.
- **Warp/Blend Background Color:** Allow you to select Warp/Blend background color. Options include None and Black (default).
- **Warp Setting:** Configure the warp setting.
 - **Warp Calibration:** Press **↑**, **↓**, **←**, or **→** to focus the point. Press Enter to select the point. Then press **↑**, **↓**, **←**, or **→** to shift the selected point location. Press **↵** to return to the previous page.
 - **Grid Points:** Set the grid points of warp pattern. Options include: 2x2 (default), 3x3, 5x5, 9x9, and 17x17.
 - **Warp Inner:** Turn On inner control. Turn Off inner control.
Note: The warp inner does not support 2x2 grid points.
 - **Warp Sharpness:** When the grid lines are warped from straight into curve, the grid lines will be distorted and become jagged.
To avoid the line jagged are too obvious, users can adjust the warp sharpness to blur or sharpen the edge of the images.
- **Blend Setting:** Configure the blend setting.
 - **Blend Width:** Set the blend pattern width. The effective range of overlap size as below:
 - (1) **Left:** 0(0%) / 192(10%) ~ 960(50%)
 - (2) **Right:** 0(0%) / 192(10%) ~ 960(50%)
 - (3) **Top:** 0(0%) / 120(10%) ~ 600(50%)
 - (4) **Down:** 0(0%) / 120(10%) ~ 600(50%)
 - **Overlap Grid Number:** Set the blend overlap grid number. Options include: 4 (default), 6, 8, 10, and 12.

USING THE PROJECTOR

- **Blend Gamma:** Set the blend gamma. Options include: 1.8, 2.0, 2.2 (default), 2.4, and 2.6.
- **Reset:** Return the factory default settings for geometric correction settings.

Signal

Adjust the signal options.

- **Automatic:** Configure automatically the signal (the frequency and phase items are grayed out). If automatic is disabled, the frequency and phase items will appear for tuning and saving the settings.
- **Frequency:** Change the display data frequency to match the frequency of your computer's graphic card. Use this function only if the image appears to flicker vertically.
- **Phase:** Synchronize the signal timing of the display with the graphic card. If the image appears to be unstable or flickers, use this function to correct it.
- **H. Position:** Adjust the horizontal positioning of the image.
- **V. Position:** Adjust the vertical positioning of the image.

Note: This menu is only available if the input source is RGB/Component.

PIP/PBP

Display an image with two sources in PIP mode or PBP mode.

Note: PIP/PBP function does not support 3D.

- **Screen:** Toggle between displaying two sources at once (Main and PIP/PBP images) or one source only.
 - **None:** Display image from the main source only.
 - **PIP:** Display images from two sources by separating the screen into two parts. One source is displayed on the main screen and another source is displayed in an inset window.
 - **PBP:** Display images from two sources by separating the screen into half. One source is displayed on the left side of the screen and the other source on the right side of the screen.
- **PIP Location:** Set the PIP location from top left, top right, bottom top, and bottom right.
- **PBP Location:** Set the PBP location from main left, main top, main right, and main bottom.
- **Size:** Set the PIP sub source size from Large, Medium, and Small.
- **Main Source:** Select an active input to be used as the main image. The available inputs include HDMI 1, HDMI 2, VGA, HDBaseT, USB, and Home.
- **Sub Source:** Select an active input to be used as the sub image. The available inputs include HDMI 1, HDMI 2, VGA, HDBaseT, USB, and Home.
- **Swap:** Change the location of the PIP/PBP, and the PIP/PBP to main image. Swapping is available only when PIP/PBP is enabled.

Note:

























A) PIP/PBP compatibility table as described below:

PIP/PBP			Main					
			VGA	HDMI 2	HDMI 1		HDBaseT	USB
				v1.4	v1.4	v2.0		
Sub	VGA		-	-	-	-	-	
	HDMI 2	v1.4	v	-	v	v	v	
	HDMI 1	v1.4	v	v	-	-	v	
		v2.0	-	-	-	-	-	
	HDBaseT		v	v	v	v	-	
USB		-	-	-	-	-		

1. Flashing lines may occur if the bandwidth of both inputs are too high, please try to reduce the resolution.

USING THE PROJECTOR

2. Frame tearing may occur due to a difference in frame rate between the Main and the Sub picture, please try to match the frame rate for each input.
- B) PIP/PBP layout and size table as described below:
- P: indicates primary source region (lighter color).

PIP/PBP Layout	PIP/PBP Size		
	Small	Medium	Large
PIP, Top Left			
PIP, Top Right			
PIP, Bottom Left			
PIP, Bottom Right			
PBP, Main Left			
PBP, Main Top			
PBP, Main Right			
PBP, Main Bottom			

Menu Settings

Set the menu location on the screen and configure menu timer settings.

- **Menu Location:** Select the menu location on the display screen.
- **Menu Timer:** Set the duration where the OSD menu stays visible on the screen.

Note: When the PIP or PBP function is turned on, the Menu Location will be unavailable.

3D Menu

Note:

- This projector is a 3D ready projector.
- Please make sure your 3D glasses are use for DLP-Link 3D or VESA 3D.
- This projector supports frame sequential 3D via the HDMI 1 and HDMI 2 ports.
- The maximum resolution is 1080P (4K 3D resolution is not supported).

3D Mode

Use this option to enable or disable the 3D function.

- **Off:** Select the “Off” to turn off 3D mode.
- **On:** Select the “On” to turn on 3D mode.

USING THE PROJECTOR

Note:

- *When the PIP or PBP function is turned on, the 3D Mode will be unavailable.*
- *When the input source switch to Home, the 3D Mode will be unavailable.*

3D Tech.

Set the 3D tech. parameter to “DLP-Link” or “3D-Sync”.

3D Format

Use this option to select the appropriate 3D format content.

- **Auto:** When a 3D identification signal is detected, the 3D format is selected automatically.
- **SBS:** Display 3D signal in “Side-by-Side” format.
- **Top and Bottom:** Display 3D signal in “Top and Bottom” format.
- **Frame Sequential:** Display 3D signal in “Frame Sequential” format. Frame Sequential encoding method is commonly used on PC content.
- **Frame Packing:** Display 3D signal in “Frame Packing” format. Frame Packing encoding method is primarily used with 1080p Blu-ray.

Note:

- *When the PIP or PBP function is turned on, the 3D Format will be unavailable.*
- *When the 3D Mode function is turned off, the 3D Format will be unavailable.*
- *When the input source switch to Home, the 3D Format will be unavailable.*

3D Sync Invert

Use this option to enable/disable the 3D sync invert function.

3D Sync Out

Transmit a 3D sync signal by the 3D sync output corrector to the emitter or to the next projector for 3D blending purposes.

L/R Reference

Source of the left or right reference.

- **Field GPIO:** Select Field GPIO to make the first 3D output signal the same for multiprojectors application.
- **1ST Frame:** This is used for single 3D projector.

3D Frame Delay

Correct asynchronous displaying of images under 3D blending.

Reset

Return the factory default settings for 3D settings.

Note:

- *When the PIP or PBP function is turned on, the Reset will be unavailable.*
- *When the 3D mode function is turned off, the Reset will be unavailable.*
- *When the input source switch to Home, the Reset will be unavailable.*

Audio Menu

Mute

Use this option to temporarily turn off the sound.

- **On:** Choose “On” to turn mute on.
- **Off:** Choose “Off” to turn mute off.

USING THE PROJECTOR

Volume

Adjust the audio volume level.

Setup Menu

Projection Mode

Select the preferred projection between Front, Rear, Ceiling-Top, and Rear-Top.

Screen Type

Select the screen type between auto, 4:3, 16:9, and 16:10.

Filter Settings

Configure the filter settings.

Note: *Only in China is equipped with a filter cover.*

- **Filter Usage Hours:** Display the filter time.
- **Optional Filter Installed:** Set the warning message setting.
 - **Yes:** Display warning message after 500 hours of use.
 - Note:** *“Filter Usage Hours / Filter Reminder / Filter Reset” will only appear when “Optional Filter Installed” is “Yes”.*
 - **No:** Turn off warning message.
- **Filter Reminder:** Choose this function to show or hide the warning message when the changing filter message is displayed. The available options include Off, 300hr, 500hr, 800hr, and 1000hr.
- **Filter Reset:** Reset the dust filter counter after replacing or cleaning the dust filter.

Lens Settings

Configure the lens function related settings.

- **Zoom:** Use to reduce or magnify an image on the projection screen.
- **Focus:** Press the “Left” or “Right” button to focus the projected image.
 - Note:**
 - *The Zoom and Focus function only support 1.25x lens/ Short Throw lens models.*
 - *When the Lens Function switch to Lock, the Zoom and Focus will be unavailable.*
- **Lens Function:** Prevent all lens motors from moving.
- **Lens Shift:** Shift the lens up and down, or left and right.
- **Lens Calibration:** Calibrate to move the lens back to center.
- **Lens Memory:** Save the current lens position after doing lens shift. Apply lens position to the chosen set of lens memory. The lens memory can save up to five locations.
 - Note:**
 - *Before process lens memory, lens calibration has to be completed.*
 - *When the Lens Function switch to Lock, the Lens Shift, Lens Calibration, and Lens Memory will be unavailable.*

Test Pattern

Select the test pattern from green grid, magenta grid, white grid, white, or disable this function (off).

High Altitude

When “On” is selected, the fans will spin faster. This feature is useful in high altitude areas where the air is thin.

USING THE PROJECTOR

Display Mode Lock

Choose “Off” or “On” to lock or unlock adjusting the display mode settings.

Keypad Lock

When the keypad lock function is “On”, the Keypad will be locked. However, the projector can be operated by the remote control. By selecting “Off”, you will be able to reuse the Keypad.

Information menu

View the projector information as listed below:

- Display
- Hardware
- Input Source
- Network
- About
- Control

USING THE PROJECTOR

System Settings Menu

On the Home screen, select the system settings menu “” to configure various system settings.

General Menu Navigation

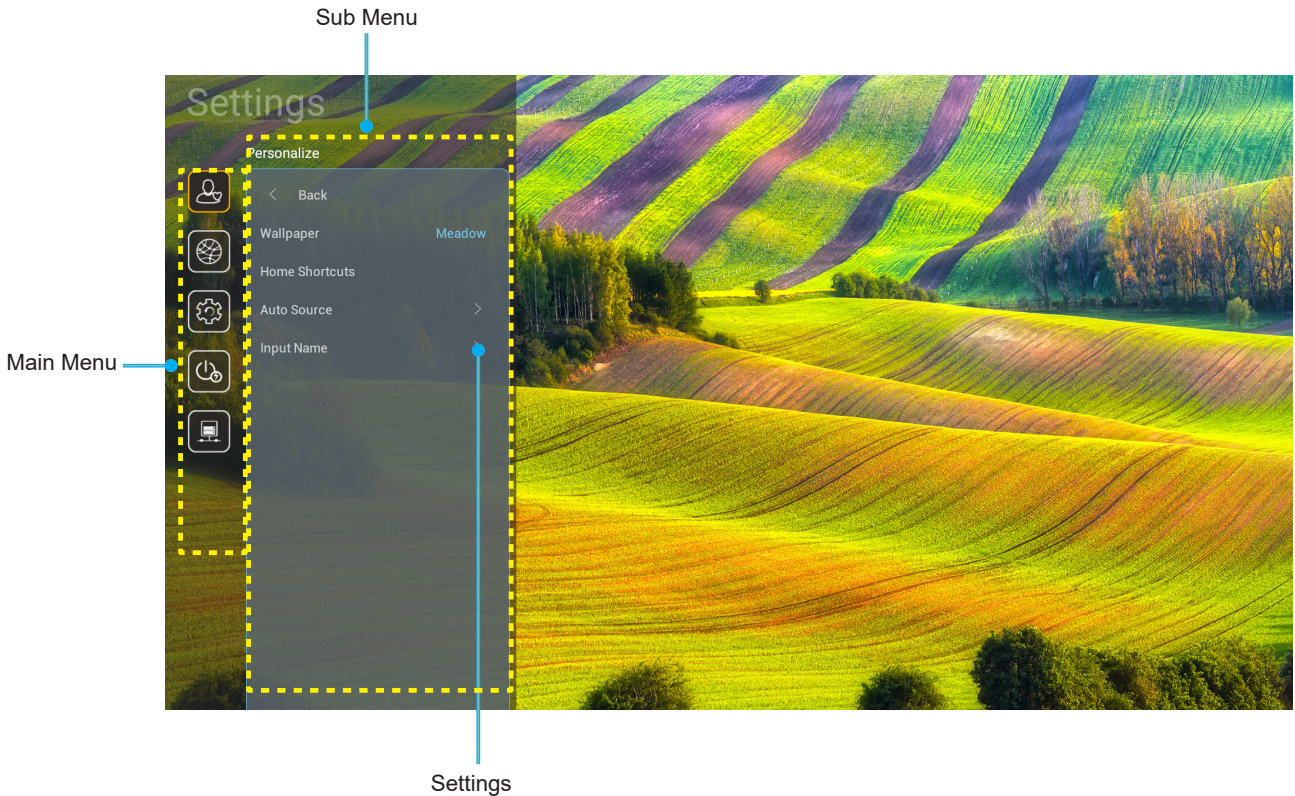

1. When system settings menu is displayed, use the up and down navigation buttons to select any item in the main menu. While making a selection on a particular page, press the “**OK**” or the “**Right**” button on the remote control to enter the submenu.
2. Press the “**Left**” and “**Right**” button to select the desired menu item. Then press “**OK**” to open its sub menu.
3. Press the “**Up**” and “**Down**” button to select the desired item in the sub menu.
4. Press the “**OK**” or “**Right**” button to access the selected sub menu item settings.
5. Press the “**Up**”, “**Down**”, “**Left**”, or “**Right**” button to select the setting or press the “**Left**” and “**Right**” button to adjust the value (if necessary).
6. Press “**OK**” to confirm the setting.
7. Select the next item to be adjusted in the sub menu and modify as described above.
8. To exit, press “**↶**” (repeatedly if necessary). The settings menu will close and the projector will automatically save the new settings.

USING THE PROJECTOR

System Settings Menu Tree

Level 1	Level 2	Level 3	Level 4	Value	
Personalize	Wallpaper			(Wallpaper selections)	
	Home Shortcut	Short Cut 1:TapCastPro			APP/Input Source
		Short Cut 2:LocalMM			APP/Input Source
		Short Cut 3			APP/Input Source
		Short Cut 4			APP/Input Source
		Short Cut 5			APP/Input Source
		Short Cut 6			APP/Input Source
	Auto Source	Auto Source			Off [Default]
					On
	Input Name		HDMI 1		[Default]
			HDMI 2		[Default]
			VGA		[Default]
			HDBaseT		[Default]
			USB		[Default]
			Home		[Default]
	Network	Ethernet	Network Status		Read Only
IP Address				Read Only	
Mac Address				Read Only	
Proxy Settings			None		
			Manuel		Proxy Hostname
					Proxy Port
				Bypass Proxy Domains	
IP Settings			DHCP		Off
					On
			Static		IP Address
					Gateway
					Network Prefix Length
					DNS 1
Reset					Cancel [Default]
					Yes
Network			LAN Control	Network Status	
	Mac Address			Read Only	
	DHCP			Off	
				On [Default]	
	IP Address	Editable		192.168.10.100	
	Subnet Mask	Editable		255.255.0.0	
	Gateway	Editable		192.168.0.254	
	DNS	Editable		168.95.1.1	
Reset			Cancel [Default]		
			Yes		

USING THE PROJECTOR

Level 1	Level 2	Level 3	Level 4	Value
System	Language			English
				Deutsch
				Français
				Italiano
				Español
				Português
				Polski
				Nederlands
				Svenska
				Norsk
				Dansk
				Suomi
				ελληνικά
				繁體中文
				简体中文
				日本語
				한국어
				Русский
				Magyar
				Čeština
			عربي	
			ไทย	
			Türkçe	
		فارسی		
		Tiếng Việt		
		Bahasa Indonesia		
		Română		
	Keyboard	Current Keyboard		
		Manage Keyboard		

USING THE PROJECTOR

Level 1	Level 2	Level 3	Level 4	Value
System	Date and Time	Date		Read Only
		Time		Read Only
		Select Time Zone		
		Daylight Saving Time		Off [Default]
				On
	Use 24-hour Format		Off [Default]	
			On	
	System Update	Auto		Off [Default]
				On
	Update			
	Internal Storage			
	Apps			TapCast Pro, Browser, LocalMM
	Legal	Terms and Conditions of Use		
		Privacy Policy		
		Cookies Policy		
Reset			Cancel [Default]	
			Reset all Settings	
			Reset to Default	
Power	Direct Power On			Off [Default]
				On
	Signal Power On			Off [Default]
				On
	Auto Power Off (min.)			0 ~ 180 (5 min increments) [Default: 20]
	Sleep Timer (min.)			Off ~ 990 (30 min increments) [Default: Off]
		Always On		On [Default]
				Yes
Power Mode (Standby)			Active	
			Eco. [Default]	
			Communication	

USING THE PROJECTOR

Level 1	Level 2	Level 3	Level 4	Value	
Control	12V Trigger			Off	
				On [Default]	
	Remote Settings	IR Function			Off
					On [Default]
		Remote Code			00 ~ 99
			F1		
					Contrast
					Color Matching
					Color Temp
					Gamma [Default]
					Projection
					Lens Shift
		F2			
					Contrast [Default]
					Color Matching
					Color Temp
					Gamma
					Projection
		F3			Lens Shift
					Brightness [Default]
					Contrast
					Color Matching
				Color Temp	
				Gamma	
	Projector ID				00 ~ 99
		HDBaseT Control	RS232		
					On

USING THE PROJECTOR

Personalize menu

Wallpaper

Allow you to change the launcher home wallpaper.

Note: *Adding custom wallpapers is not supported.*

Home Shortcut

Review Home screen shortcuts of all opened apps in each input source. The items cannot repeat except for “Automatic” option which means the system will remember up to six latest apps that have been opened and then will replace app shortcuts so that the latest app will be the first app in the apps list while other apps in the list are shifted by one position.

Auto Source

Choose this option to let the projector automatically find an available input source.

Input Name

Use to rename the input function for easier identification. The available options include HDMI 1, HDMI 2, VGA, HDBaseT, USB, and Home.

Network menu

Ethernet

Configure wired network settings.

Note:

- *Make sure you have connected the projector to local area network (LAN).*
- *When using Tapcast Pro, Browser, System update (FOTA), and Date and Time functions, make sure that Ethernet is connected.*
- **Network Status:** Display the network connection status (read-only).
- **IP Address:** Display the IP address (read-only).
- **Mac Address:** Display the MAC address (read-only).
- **Proxy Settings:** Provide proxy hostname, connection port and bypass proxy domains information manually if requested.
- **IP Settings:** Enable DHCP if you want the projector to obtain IP address and other connection parameters automatically from your network. Disable DHCP if you want to assign IP address, gateway, network prefix length, and DNS parameters manually.
- **Reset:** Return the factory default settings for network settings.

LAN Control

Configure the local area network (LAN) settings.

Note: *Before using ProService Local, Crestron, Extron, PJLink, Tenlet and Web management, please make sure you are connected to the LAN and set Password by Web browser.*

- **Network Status:** Display the network connection status (read-only).
- **Mac Address:** Display the MAC address (read-only).
- **DHCP:** Use this option to enable and disable the DHCP function.
 - **Off:** To assign IP, subnet mask, gateway, and DNS configuration manually.
 - **On:** Projector will obtain an IP address automatically from your network.

USING THE PROJECTOR

Note: *Exiting OSD will automatically apply the entered values.*

- **IP Address:** Display the IP address.
- **Subnet Mask:** Display subnet mask number.
- **Gateway:** Display the default gateway of the network connected to the projector.
- **DHS:** Display the DNS number.
- **Reset:** Reset all values for LAN parameters.

System menu

Language

Select your preferred system language between English, French, German, Spanish, Italian, Portuguese, Dutch, Swedish, Finnish, Greek, Danish, Norwegian, Polish, Russian, Simplified Chinese, Traditional Chinese, Korean, Arabic, Japanese, Thai, Hungarian, Czechoslovak, Turkish, Farsi, Vietnamese, Indonesian, and Romanian.

Keyboard

Select the keyboard language.

Date and Time

Configure the date and time settings.

- **Date:** Display the date (read-only).
- **Time:** Display the time (read-only).
- **Select Time Zone:** Select the time zone in your location.
- **Daylight Saving Time:** Set the daylight saving time.
- **Use 24-hour Format:** Set to “On” to display time in 24-hour format. Set to “Off” to display time in 12-hour format (AM/PM).

System Update

System will look for updates automatically every time the projector is connected to the Internet (OTA).

Internal Storage

View the internal storage usage.

Apps

Configure the apps. Options include: TapCast Pro, Browser, and LocalMM.

Note: *Adding apps to the projector by user is not supported.*

Legal

Review legal documents including “Terms and Conditions of Use”, “Privacy Policy”, and “Cookies Policy”.

Note: *You can review legal documents online as well. Please refer to the following web addresses:*

- **Terms and Conditions of Use:** <https://www.optoma.com/terms-conditions/>
- **Privacy Policy:** <https://www.optoma.com/cookies-policy/>
- **Cookies Policy:** <https://www.optoma.com/software-privacy-policy/>

Reset

Reset all settings including data (“Reset all settings”) or reset settings to the factory defaults only (“Reset to Default”). Select “Cancel” to exit the menu and keep the current configuration.

Note: *After you select “Reset to Default”, the projector will automatically turn off. To start the recovery procedure, turn on the projector.*

USING THE PROJECTOR

Power menu

Direct Power On

Choose “On” to activate Direct Power mode. The projector will automatically power on when AC power is supplied, without pressing the “Power” button on the projector keypad or on the remote control.

Signal Power On

Choose “On” to activate Signal Power mode. The projector will automatically power on when a signal is detected, without pressing the “Power” key on the projector Keypad or on the remote control.

Auto Power Off (min.)

Set the countdown timer interval. The countdown timer will start, when there is no signal being sent to the projector. The projector will automatically power off when the countdown has finished (in minutes).

Sleep Timer (min.)

Set the countdown timer interval. The countdown timer will start, with or without a signal being sent to the projector. The projector will automatically power off when the countdown has finished (in minutes).

Power Mode (Standby)

Configure power mode settings in standby.

- **Active:** Choose “Active” to return to normal standby.
- **Eco:** Choose “Eco.” to save power dissipation further < 0.5W.
- **Communication:** The projector can be controlled via the LAN terminal during power standby.

Note: *The differences between these three power mode settings are as follows:*

Standby Mode	Active	Eco	Communication
RS232 Power Status	O	O	O
RS232 Info/Lamp/Hours	O	O	O
Power ON (Command)			
Keypad ON	O	O	O
IR ON	O	O	O
RS232 ON	O	O	O
LAN (Browser)	O	X	O
HDBaseT (RS232 ON)	X	X	O
Signal Power ON (Video Signal)			
HDBaseT	X	X	X
HDMI 1/2	O	O	O
VGA	O	O	O
Other	X	X	X
LAN/Ethernet ON	O	X	O
HDMI Out (Loop through)	X	X	X
HDMI AMP (Loop through W/O projector is ON)	X	X	X
Audio Out (Loop through)	X	X	X
Projector can provide EDID information to external derive	X	X	X
Direct Power ON	O	O	O

USING THE PROJECTOR

Control menu

12V Trigger

Use this function to enable or disable the trigger.

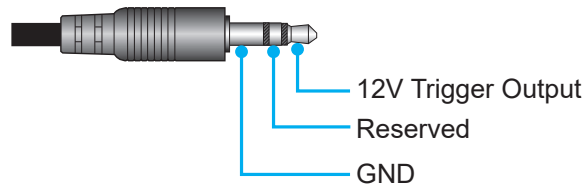

- **Off:** Choose “Off” to disable the trigger.
- **On:** Choose “On” to enable the trigger.

Remote Settings

- **IR Function:** Set the IR function setting.
 - **Off:** Choose “Off”, the projector can’t be operated by the remote control. By selecting “Off”, you will be able to use the Keypad keys.
 - **On:** Choose “On”, the projector can be operated by the remote control from the top and front IR receivers.
- **Remote Code:** Set the remote custom code by pressing the remote ID button for 3 seconds and you will notice the remote indicator (above the Off button) starts blinking. Then, input a number between 00-99 using the keyboard numbered keys. After inserting the number, the remote indicator blinks twice quickly indicating that the remote code has changed.
- **F1/F2/F3:** Assign the default function for F1, F2, or F3 between Brightness (F3 default), Contrast (F2 default), Color Matching, Color Temp, Gamma (F1 default), Projection, or Lens Shift.
- **Projector ID:** ID definition can be set up by menu (range 0-99), and allow user control an individual projector by using RS232 command.
- **HDBaseT Control:** Choose “On” to set the serial port path to RS232.

USING THE PROJECTOR

Selecting an Input Source

You can select any input source directly on the Home screen using an input shortcut.

Note: You can personalize shortcut settings in “System Settings menu  → Personalize → Home Shortcut”. You can also modify the shortcut order on the Home screen.

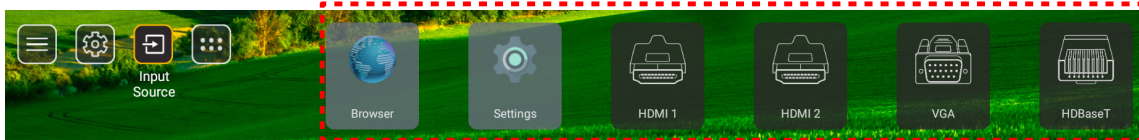

If the desired input source is not visible on the Home screen, select “” to view all input options. Then select your input source or select “HOME” to return to the Home screen.

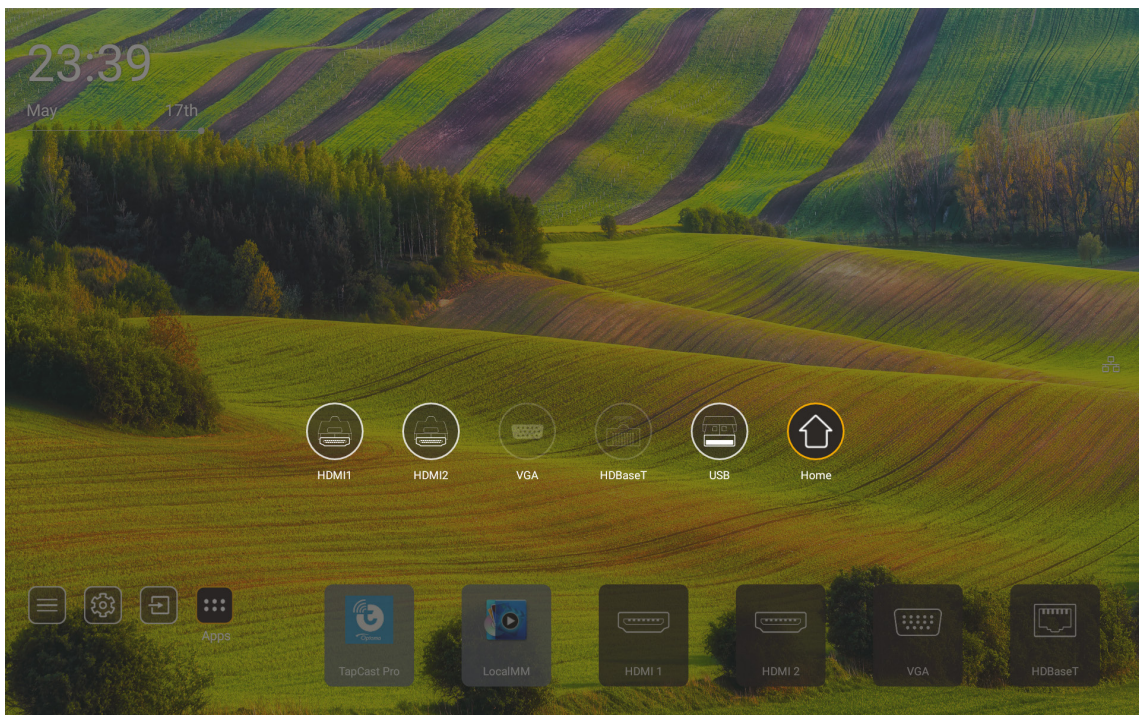

Note: The projector can be set to notify the input switching confirmation message when an input source is detected and automatically or manually switch to the currently detected input source. Refer to page 52. The hot key that exit in keypad control. Press it to view all input source when input source without OSD menu tree.

USING THE PROJECTOR

Selecting an App

You can select any app directly on the Home screen using an app shortcut.

Note: You can personalize shortcut settings in “System Settings menu → Personalize → Home Shortcut”.

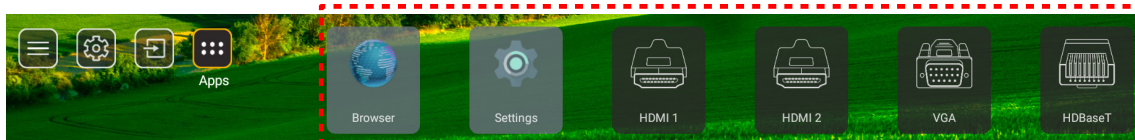

If the desired app is not visible on the Home screen, select “” to view all installed apps. Then select your desired app.

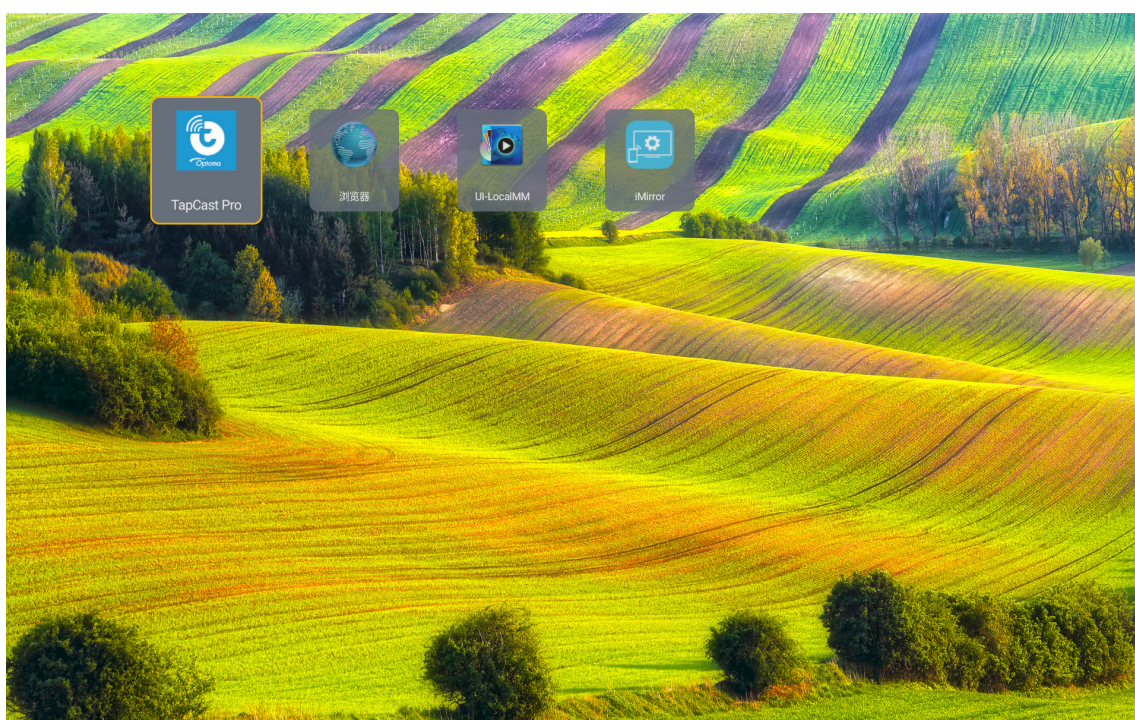

USING THE PROJECTOR

Multimedia mode and supported multimedia format

To play multimedia files, connect a USB storage with multimedia content to the projector. Then open the multimedia player and select the desired files to play.

1. Press the “USB” button on the remote control or you can press the “Source” button to display source menu and then select the USB icon to access.
2. Press the “Home” button to return to multimedia main menu.
3. Press the ↑, ↓, ←, →, ↶, and Enter buttons to select/execute the function.’

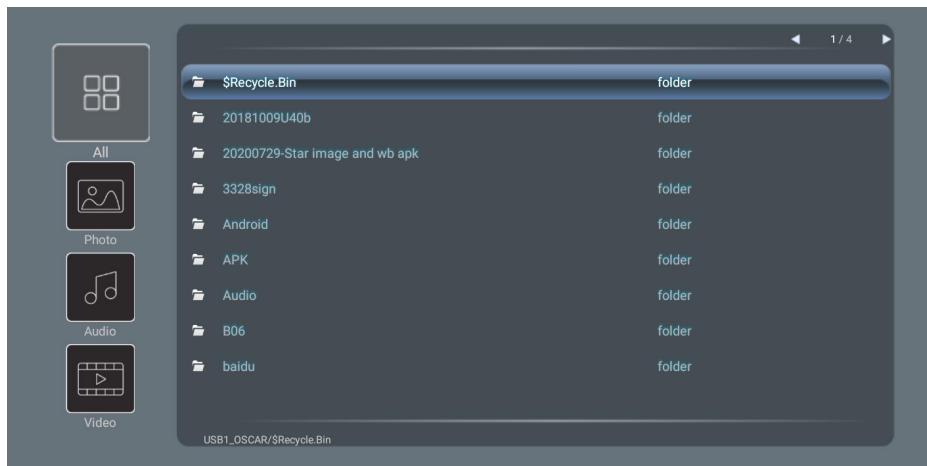

Classification:

Item		Description
	All	Display all files stored in USB device
	Photo	Display only photo files stored in USB device
	Audio	Display only audio files stored in USB device
	Video	Display only video files stored in USB device

Note: Multimedia mode is not applicable for VGA and HDMI input source.

USING THE PROJECTOR

Photo Playback:













Item	Description	
	Back	Skip to the previous file in the playlist.
	Play	Start or restart playback. The icon becomes the  icon when activated.
	Pause	Pause playback. The icon becomes the  icon when activated.
	Forward	Skip to the next file.
	Zoom In	Zoom in on a photo.
	Zoom Out	Zoom out on a photo.
	Rotate Left	Rotate a photo by 90 degrees counterclockwise.
	Rotate Right	Rotate a photo by 90 degrees clockwise.
	Info	Open the photo information of the current file.









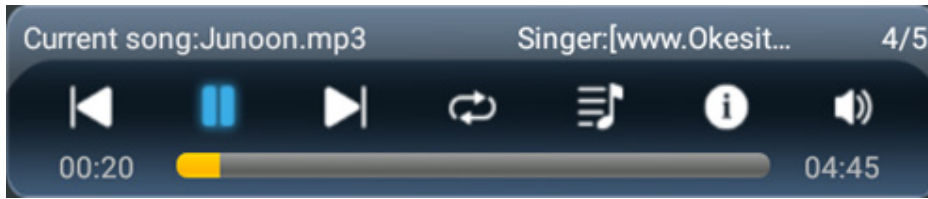







Photo Support List:

Image Type (Ext Name)	Sub Type	Maximum Pixels
JPEG	Base-line	8000 x 8000
	Progressive	6000 x 4000
BMP		6000 x 4000

USING THE PROJECTOR

Audio Playback:



Item	Description	
	Back	Skip to the previous file in the playlist.
	Play	Start or restart playback. The icon becomes the  icon when activated.
	Pause	Pause playback. The icon becomes the  icon when activated.
	Forward	Skip to the next file.
	Cycle	Toggle the playback cycle mode: Repeat all/ Repeat Once/Random
	Playlist	Open the playlist. <ul style="list-style-type: none"> Press the  /  buttons to select a file in the Playlist, and press the "Enter" button to execute. Press the  button to exit the playlist.
	Info	Open the audio information of the current file.
	Volume	Open the volume bar for adjusting the playback volume output.
	Volume Bar	Press the  /  buttons to increase/decrease the volume level.

USING THE PROJECTOR









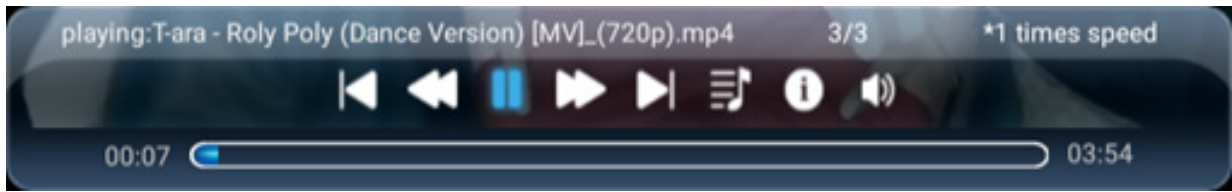







Audio Support List:

Media Category	Decoder	Supported File Formats
Audio	MPEG1/2 Layer1	MP3 (.mp3)
		AVI (.avi)
		MP4 (.mp4, .mov, .m4a)
		MPEG transport stream (.ts, .trp, .tp)
		MPEG program stream (.DAT, .VOB, .MPG, .MPEG)
	MPEG1/2 Layer2	MP3 (.mp3)
		AVI (.avi)
		Matroska (.mkv, .mka)
		MP4 (.mp4, .mov, .m4a)
		MPEG transport stream (.ts, .trp, .tp)
		MPEG program stream (.DAT, .VOB, .MPG, .MPEG)
	MPEG1/2/2.5 Layer3	MP3 (.mp3)
		Matroska (.mkv, .mka)
		MP4 (.mp4, .mov, .m4a)
		MPEG transport stream (.ts, .trp, .tp)
		MPEG program stream (.DAT, .VOB, .MPG, .MPEG)
	AAC, HEAAC	AAC (.aac)
		MP4 (.mp4, .mov, .m4a)
		MPEG transport stream (.ts, .trp, .tp)
		MPEG program stream (.DAT, .VOB, .MPG, .MPEG)
	LPCM	WAV (.wav)
		AVI (.avi)
		Matroska (.mkv, .mka)
		MP4 (.mp4, .mov, .m4a)
MPEG transport stream (.ts, .trp, .tp)		
MPEG program stream (.DAT, .VOB, .MPG, .MPEG)		
IMA-ADPCM MS-ADPCM	WAV (.wav)	
	AVI (.avi)	
	Matroska (.mkv, .mka)	
	MP4 (.mp4, .mov, .m4a)	

USING THE PROJECTOR

Video Playback:



Item	Description	
	Back	Skip to the previous file in the playlist.
	Fast Rewind	Fast rewind at 1x/2x/4x/8x/16x/32x playback speed.
	Play	Start or restart playback. The icon becomes the  icon when activated.
	Pause	Pause playback. The icon becomes the  icon when activated.
	Fast Forward	Fast forward at 1x/2x/4x/8x/16x/32x playback speed.
	Forward	Skip to the next file.
	Playlist	Open the playlist. <ul style="list-style-type: none"> Press the  /  buttons to select a file in the Playlist, and press the "Enter" button to execute. Press the  button to exit the playlist.
	Info	Open the audio information of the current file.
	Volume	Open the volume bar for adjusting the playback volume output.
	Volume Bar	Press the  /  buttons to increase/decrease the volume level.

Video Support List:

Image Type (Ext Name)	Sub Type	Maximum Pixels
Video	MPEG1/2	MPEG program stream (.DAT, .VOB, .MPG, .MPEG)
	MPEG4	MP4 (.mp4, .mov)
		AVI (.avi)
	H.264	MP4 (.mp4, .mov)
		AVI (.avi)
	VC1	WMV (.wmv)
Motion JPEG	AVI (.avi)	

USING THE PROJECTOR

Viewing the status bar

By default, the Status Bar on the Home screen contains icons indicating connection status regarding wired network, and USB (if applicable). You can select any of the icons to open the associated menu. Selecting wired status icon results in opening the network configuration menu, while selecting the USB status icon results in opening the browser and displaying the content of the connected USB device.

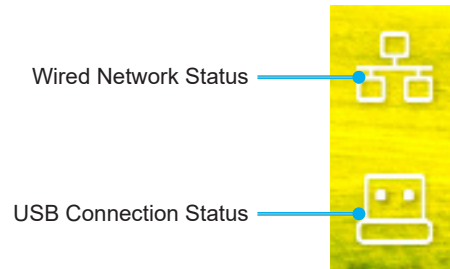

ADDITIONAL INFORMATION

Compatible Resolutions

Digital

Established Timing	Standard Timing	Descriptor Timing	Supported Video Mode	Detail Timing
720 x 400 @ 70Hz	1280 x 800 @ 60Hz 16:10	WU: 1920x1200 @ 60Hz	640 x 480p @ 60Hz 4:3	1280 x 720P @ 60Hz
640 x 480 @ 60Hz	1280 x 960 @ 60Hz 4:3		720 x 480p @ 60Hz 4:3	720 x 480P @60
640 x 480 @ 72Hz	1400 x 1050 @ 60Hz 4:3		720 x 480p @ 60Hz 16:9	1920 x 1080P @ 60H
640 x 480 @ 75Hz	1600 x 1200 @ 60Hz 4:3		1280 x 720p @ 60Hz 16:9	720 x 576P @50
800 x 600 @ 56Hz	1440 x 900 @ 60Hz 16:10		1920 x 1080p @ 60Hz 16: 9	
800 x 600 @ 60Hz	1280 x 720 @ 120Hz 16:9		720 x 576p @ 50Hz 4:3	HDMI 2.0 ONLY
800 x 600 @ 72Hz	1024 x 768 @ 120Hz 4:3		720 x 576p @ 50Hz 16:9	3840 x 2160P @ 60 Hz
800 x 600 @ 75Hz	1680 x 1050 @ 60Hz 16:10		1280 x 720p @ 50Hz 16:9	
832 x 624 @ 75Hz			1920 x 1080P @ 50Hz 16.9	
1024 x 768 @ 60Hz			1920 x 1080p @ 24Hz 16:9	
1024 x 768 @ 70Hz			1280 x 720p @ 120Hz 16:9	
1024 x 768 @ 75Hz				
1280 x 1024 @ 75Hz			HDMI 2.0 ONLY	
1152 x 870 @ 75Hz			3840 x 2160p @ 24 Hz 16:9	
			3840 x 2160p @ 25 Hz 16:9	
			3840 x 2160p @ 30 Hz 16:9	
			3840 x 2160p @ 50 Hz 16:9	
			3840 x 2160p @ 60 Hz 16:9	
			4096 x 2160p @ 24 Hz 256:135	
			4096 x 2160p @ 25 Hz 256:135	
			4096 x 2160p @ 30 Hz 256:135	
			4096 x 2160p @ 50 Hz 256:135	
			4096 x 2160p @ 60 Hz 256:135	

ADDITIONAL INFORMATION

Analog

Established Timing	Standard Timing	Descriptor Timing	Supported Video Mode	Detail Timing
720 x 400 @ 70Hz	1080P/UW:	WU: 1920x1200 @ 60Hz		
640 x 480 @ 60Hz	1280 x 800 @ 60Hz 16:10			
640 x 480 @ 72Hz	1280 x 960 @ 60Hz 4:3			
640 x 480 @ 75Hz	1400 x 1050 @ 60Hz 4:3			
800 x 600 @ 56Hz	1600 x 1200 @ 60Hz 4:3			
800 x 600 @ 60Hz	1440 x 900 @ 60Hz 16:10			
800 x 600 @ 72Hz	1280 x 720 @ 120Hz 16:9			
800 x 600 @ 75Hz	1024 x 768 @ 120Hz 4:3			
832 x 624 @ 75Hz	1680 x 1050 @ 60Hz 16:10			
1024 x 768 @ 60Hz				
1024 x 768 @ 70Hz				
1024 x 768 @ 75Hz				
1280 x 1024 @ 75Hz				
1152 x 870 @ 75Hz				

Note: Support 1920 x 1080 @ 50Hz.

ADDITIONAL INFORMATION

RS232 Port Setting and Signals Connection

RS232 Port Setting

Items	Method
Communication Method	Asynchronous Communication
Bits Per Seconds	9600
Data Bits	8 bits
Parity	None
Stop Bits	1
Flow Control	None

RS232 Signals Connection

Computer COM Port
(D-Sub 9-pin conner)

Porjector COM Port
(D-Sub 9-pin conner)

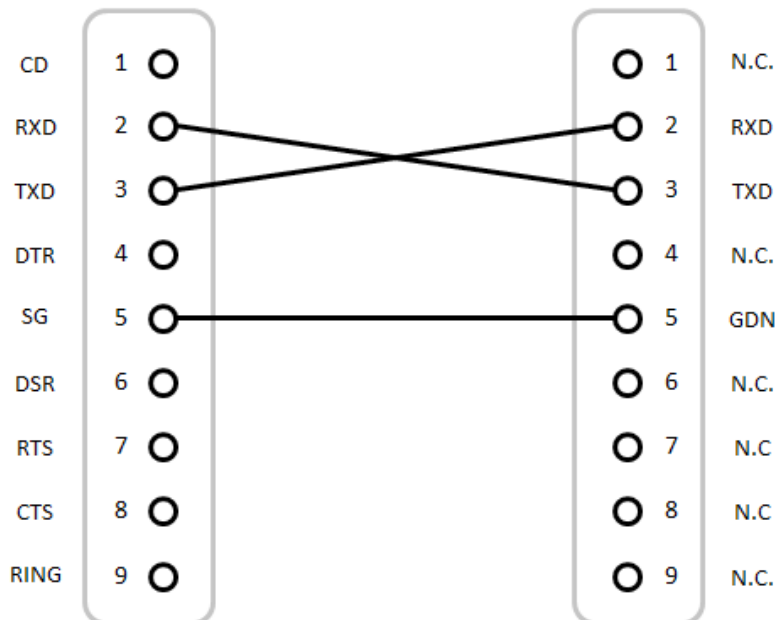

Note: RS232 shell is grounded.

ADDITIONAL INFORMATION

Installing and Cleaning the Dust Filter

Installing the Dust Filter

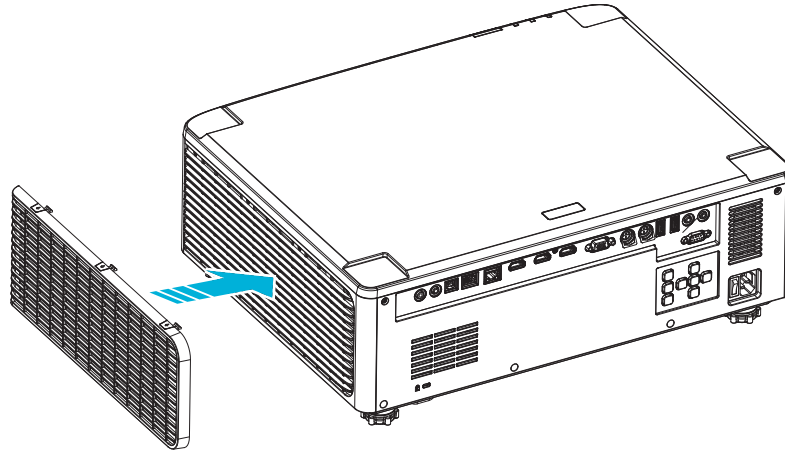

Note: Dust filters are only required/supplied in the selected regions with excessive dust.

Cleaning the Dust Filter

We recommend you to clean the dust filter every three months. Clean it more often if the projector is used in a dusty environment.

Proce

1. Switch off the power to the projector by pressing the “ ” button on the projector keypad or the “ ” button on the remote control.
2. Disconnect the power cord.
3. Remove the dust filter compartment from the left side of the projector. **1**
4. Carefully remove the air filter. Then clean or replace the dust filter. **2**
5. To install the dust filter, reverse the previous steps.

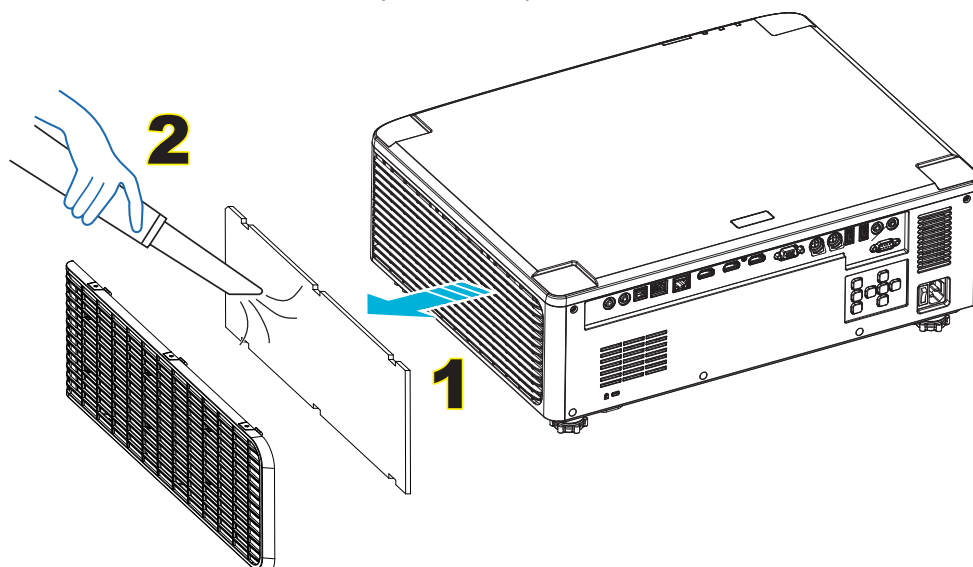

ADDITIONAL INFORMATION

Image Size and Projection Distance

1.8x lens model

The size of projected images is 40 ~ 300 inches (1.02 ~ 7.62 m)

Screen Size 16:10 (Wx H)						Throw Ratio		Projector Distance			
Diagonal Length of Image		Width		Height				Wide		Tele	
inch	m	inch	m	inch	m	Wide	Tele	inch	m	inch	m
40	1.02	33.9	0.86	21.2	0.54	1.36	2.51	46.1	1.17	85.0	2.16
50	1.27	42.4	1.08	26.5	0.67	1.36	2.51	57.9	1.47	106.7	2.71
60	1.52	50.9	1.29	31.8	0.81	1.38	2.52	70.1	1.78	128.3	3.26
70	1.78	59.4	1.51	37.1	0.94	1.38	2.52	81.9	2.08	150.0	3.81
80	2.03	67.8	1.72	42.4	1.08	1.38	2.53	93.7	2.38	171.7	4.36
90	2.29	76.3	1.94	47.7	1.21	1.38	2.53	105.9	2.69	193.3	4.91
100	2.54	84.8	2.15	53.0	1.35	1.39	2.54	117.7	2.99	215.0	5.46
120	3.05	101.8	2.58	63.6	1.62	1.39	2.54	141.7	3.60	258.3	6.56
150	3.81	127.2	3.23	79.5	2.02	1.4	2.54	177.6	4.51	323.2	8.21
180	4.57	152.6	3.88	95.4	2.42	1.4	2.54	213.4	5.42	388.2	9.86
200	5.08	169.6	4.31	106.0	2.69	1.4	2.54	37.0	6.02	431.5	10.96
250	6.35	212.0	5.38	132.5	3.37	1.4	2.55	296.8	7.54	540.2	13.72
300	7.62	254.4	6.46	159.0	4.04	1.4	2.55	356.7	9.06	648.4	16.47

1.25x lens models

The size of projected images is 50 ~ 300 inches (1.27 ~ 7.62 m)

Screen Size 16:10 (Wx H)						Throw Ratio		Projector Distance			
Diagonal Length of Image		Width		Height				Wide		Tele	
inch	m	inch	m	inch	m	Wide	Tele	inch	m	inch	m
50	1.27	42.4	1.08	26.5	0.67	1.21	1.52	51.1	1.30	64.4	1.63
60	1.52	50.7	1.29	31.7	0.81	1.21	1.52	61.6	1.57	77.5	1.97
70	1.78	59.4	1.51	37.1	0.94	1.21	1.53	72.1	1.83	90.6	2.30
80	2.03	67.8	1.72	42.4	1.08	1.22	1.53	82.6	2.10	103.7	2.63
90	2.29	76.5	1.94	47.8	1.21	1.22	1.53	93.0	2.36	116.8	3.97
100	2.54	84.8	2.15	53.0	1.35	1.22	1.53	103.5	2.63	129.9	3.30
120	3.05	101.8	2.59	63.6	1.62	1.22	1.53	124.5	3.16	156.1	3.97
150	3.81	127.2	3.23	79.5	2.02	1.23	1.54	155.9	3.96	195.5	4.96
180	4.57	152.6	3.88	95.4	2.42	1.23	1.54	187.3	4.76	234.8	5.96
200	5.08	169.6	4.31	106.0	2.69	1.23	1.54	208.2	5.29	261.0	6.63
250	6.35	212.0	5.38	132.5	3.37	1.23	1.54	260.6	6.62	326.6	8.29
300	7.62	254.4	6.46	159.0	4.04	1.23	1.54	313.0	7.95	386.6	9.96

ADDITIONAL INFORMATION

Short Throw lens models

The size of projected images is 50 ~ 300 inches (1.27 ~ 7.62 m)

Screen Size 16:10 (Wx H)						Throw Ratio		Projector Distance			
Diagonal Length of Image		Width		Height				Wide		Tele	
inch	m	inch	m	inch	m	Wide	Tele	inch	m	inch	m
50	1.27	42.4	1.08	26.5	0.67	0.74	0.94	31.2	0.79	39.9	1.01
60	1.52	50.7	1.29	31.7	0.81	0.74	0.95	37.7	0.96	48.1	1.22
70	1.78	59.4	1.51	37.1	0.94	0.74	0.95	44.1	1.12	56.3	1.43
80	2.03	67.8	1.72	42.4	1.08	0.75	0.95	50.6	1.28	64.5	1.64
90	2.29	76.5	1.94	47.8	1.21	0.75	0.95	57.0	1.45	72.7	1.85
100	2.54	84.8	2.15	53.0	1.35	0.75	0.95	63.5	1.61	80.8	2.05
120	3.05	101.8	2.59	63.6	1.62	0.75	0.96	76.4	1.94	97.2	2.47
150	3.81	127.2	3.23	79.5	2.02	0.75	0.96	95.8	2.43	121.8	3.09
180	4.57	152.6	3.88	95.4	2.42	0.75	0.96	115.1	2.92	146.4	3.72
200	5.08	169.6	4.31	106.0	2.69	0.75	0.96	128.0	3.25	162.8	4.13
250	6.35	212.0	5.38	132.5	3.37	0.76	0.96	160.3	4.07	203.7	5.17
300	7.62	254.4	6.46	159.0	4.04	0.76	0.96	192.6	4.89	244.7	6.21

ADDITIONAL INFORMATION

Ceiling Mount Installation

1. To prevent damage to your projector, please use the Optoma ceiling mount.
2. If you wish to use a third party ceiling mount kit, please ensure the screws used to attach a mount to the projector meet the following specifications:
 - Screw type: M4*4
 - Minimum screw length: 10 mm

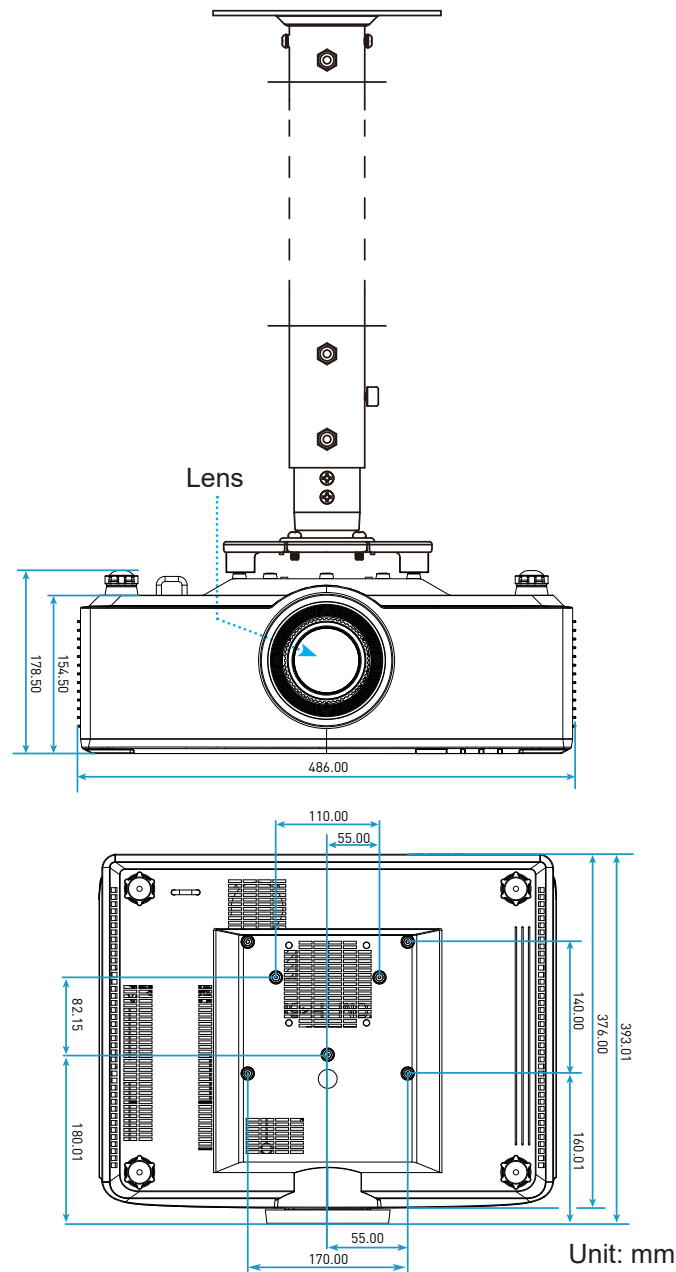

Note: Please note that damage resulting from incorrect installation will void the warranty.

ADDITIONAL INFORMATION

Troubleshooting

If you experience a problem with your projector, please refer to the following information. If a problem persists, please contact your local reseller or service center.

Image problems

- ❓ *No image appears on-screen*
 - Ensure all the cables and power connections are correctly and securely connected as described on page 16.
 - Ensure the pins of connectors are not crooked or broken.

- ❓ *Image is out of focus*
 - Make sure the projection screen is between the required distance from the projector. Refer to page 68.
 - Turn the focus ring clockwise or counterclockwise until the image is sharp and legible. Refer to page 21.

- ❓ *The image is stretched when displaying 16:9 DVD title*
 - When you play anamorphic DVD or 16:9 DVD, the projector will show the best image in 16: 9 format on projector side.
 - If you play 4:3 format DVD title, please change the format as 4:3 in projector OSD.
 - Please setup the display format as 16:9 (wide) aspect ratio type on your DVD player.

- ❓ *Image is too small or too large*
 - Move the projector closer to or further from the screen.
 - Press "≡" on the remote control, go to "OSD menu → Display → Aspect Ratio". Try the different settings.
 - Press "≡" on the remote control, go to "OSD menu → Display → Geometric Correction → Warp Calibration". Try the different settings.

- ❓ *Image has slanted sides:*
 - If possible, reposition the projector so that it is centered on the screen and below the bottom of the screen.

- ❓ *Image is reversed*
 - Select "OSD menu → Setup → Projection Mode" and adjust the projection direction.

- ❓ *No sound*
 - Please refer to the supported audio file format on page 58.
 - Ensure that the "Mute" feature is not turned on.
 - Ensure that the "Internal Speaker" feature is turned on. Refer to page 42.

- ❓ *No sound from HDMI ARC source*
 - Select "OSD menu → Audio → Digital Output → Bitstream/ PCM/ Auto". Try the different settings.

ADDITIONAL INFORMATION

- ❓ *Abnormal HDMI image*
 - Select “OSD menu → Display → HDMI 1 EDID/ HDMI 2 EDID/ HDMI 3 EDID” to “1.4” or “2.2”.
- ❓ *Blurry double image*
 - Make sure “OSD menu → 3D → 3D Tech.” is not on to avoid normal 2D image appear blurry double image.
- ❓ *Two images, side-by-side format*
 - Set the “OSD menu → 3D → “3D Format” to “SBS”.

Other problems

- ❓ *The projector stops responding to all controls*
 - If possible, turn off the projector, then unplug the power cord and wait at least 20 seconds before reconnecting power.

Remote control problems

- ❓ *If the remote control does not work*
 - Check the operating angle of the remote control is pointed within $\pm 15^\circ$ to the IR receiver on the projector.
 - Make sure batteries are inserted correctly.
 - Try to operate the remote control by pointing it to the projected image.
 - Charge battery if it is exhausted.

ADDITIONAL INFORMATION

LED Lightning Messages

Status	Light LED	Power		Temp LED
	Red	Red	Green	Red
Standby	N/A	Steady light	N/A	N/A
Power On	N/A	N/A	Steady light	N/A
Warning Up Start	N/A	Flashing (1 sec off / 1 sec on)	N/A	N/A
Cooling Down Start	N/A	N/A	Flashing (0.5 sec off / 0.5 sec on)	N/A
AV Mute	Flashing (1 sec off / 1 sec on)	N/A	Steady light	N/A
Error (Power Failure)	Steady light	N/A	N/A	Steady light
Error (Fan Failure)	N/A	N/A	N/A	Flashing (3 sec on / 3 sec off)
Error (Color Wheel Breakdown)	N/A	N/A	N/A	Flashing (0.5 sec off / 0.5 sec on)
Error (Over Temp)	N/A	N/A	N/A	Steady light
Error (LD Over Temp)	N/A	N/A	N/A	Steady light
Error (LD Voltage Failure)	Steady light	N/A	N/A	N/A
Error (Temp Sensor Disconnect)	Flashing (0.5 sec off / 0.5 sec on)	Flashing (0.5 sec off / 0.5 sec on)	N/A	N/A
Error (LD Failure)	Steady light	N/A	Steady light	N/A
Upgrade Process	Flashing (3 sec off / 3 sec on)	Flashing (3 sec off / 3 sec on)	Flashing (3 sec off / 3 sec on)	Flashing (3 sec off / 3 sec on)

Note: The light off for 10min when projector into upgrade process and All LED Flashing (3 sec off/ 3 sec on)

ADDITIONAL INFORMATION

Specifications

Optical	Description		
Lens type	1.8x	1.25x	Short Throw
Throw ratio	1.44~2.59	1.22~1.52	0.75~0.95
Maximum resolution	WUXGA	WUXGA	WUXGA
Zoom & focus adjustment	Manual	Power	Power
Image size (diagonal)	40"~300"	50"~300"	50"~300"
Projection distance	1.2 m to 16.5 m	1.31 m to 9.82 m	0.81 m to 6.13 m

Electrical	Description
Inputs	<ul style="list-style-type: none"> - HDMI 1 v2.0/4K - HDMI 2 v1.4a - VGA-IN - 3D SYNC IN - USB Type-A x2 for power USB 5V/1.8A - USB Type-B for service - AUDIO-IN 3.5mm
Outputs	<ul style="list-style-type: none"> - HDMI OUT - 3D SYNC OUT for power 5V - AUDIO-OUT 3.5mm - 12V OUT Trigger
Control	<ul style="list-style-type: none"> - Wired IR - HDBaseT - RJ-45 (support web control) - RS232
Color reproduction	1073.4 Million color
Scan rate	<ul style="list-style-type: none"> - Horizontal scan rate: 15.38 ~ 91.15 KHz - Vertical scan rate: 24 ~ 85 Hz (120 Hz for 3D feature)
Built-in speaker	2x 10W speakers
Power requirement	100 - 240V ±10%, AC 50/60Hz
Input current	6.3A (1.8x lens/ST 7K model) 5.5A (1.25x lens/ST 6K model)
Installation orientation	Front, Rear, Ceiling-top, and Rear-top
Dimensions (W x D x H)	<ul style="list-style-type: none"> - 486 x 376 x 154 mm (without feet) - 486 x 376 x 178 mm (with feet)
Weight	13 ± 0.5 Kg
Environmental conditions	Operating in 5 ~ 40°C , 10% to 85% humidity (non-condensing)

Note: All specifications are subject to change without notice.



ADDITIONAL INFORMATION

Optoma global offices

For service or support, please contact your local office.



USA

47697 Westinghouse Drive,
Fremont, CA 94539, USA
www.optomausa.com

 888-289-6786
 510-897-8601
 services@optoma.com



Canada

47697 Westinghouse Drive,
Fremont, CA 94539, USA
www.optomausa.com

 888-289-6786
 510-897-8601
 services@optoma.com

Latin America

47697 Westinghouse Drive,
Fremont, CA 94539, USA
www.optomausa.com

 888-289-6786
 510-897-8601
 services@optoma.com



Europe

Unit 1, Network 41, Bourne End Mills,
Hemel Hempstead, Herts,
HP1 2UJ, United Kingdom
www.optoma.eu
Service Tel : +44 (0)1923 691865

 +44 (0) 1923 691 800
 +44 (0) 1923 691 888
 service@tsc-europe.com



Benelux BV

Randstad 22-123
1316 BW Almere
The Netherlands
www.optoma.nl

 +31 (0) 36 820 0252
 +31 (0) 36 548 9052

France

Bâtiment E
81-83 avenue Edouard Vaillant
92100 Boulogne Billancourt, France

 +33 1 41 46 12 20
 +33 1 41 46 94 35
 savoptoma@optoma.fr



Spain

C/ José Hierro,36 Of. 1C
28522 Rivas VaciaMadrid,
Spain

 +34 91 499 06 06
 +34 91 670 08 32



Deutschland

Wiesenstrasse 21 W
D40549 Düsseldorf,
Germany

 +49 (0) 211 506 6670
 +49 (0) 211 506 66799
 info@optoma.de

Scandinavia



Lerpeveien 25
3040 Drammen
Norway

 +47 32 98 89 90
 +47 32 98 89 99
 info@optoma.no

PO.BOX 9515
3038 Drammen
Norway

Korea

WOOMI TECH.CO.,LTD.
4F, Minu Bldg.33-14, Kangnam-Ku,
Seoul,135-815, KOREA
korea.optoma.com

 +82+2+34430004
 +82+2+34430005



Japan

東京都足立区綾瀬3-25-18
株式会社オーエス
コンタクトセンター:0120-380-495

 info@os-worldwide.com
www.os-worldwide.com



Taiwan

12F., No.213, Sec. 3, Beixin Rd.,
Xindian Dist., New Taipei City 231,
Taiwan, R.O.C.
www.optoma.com.tw

 +886-2-8911-8600
 +886-2-8911-6550
 services@optoma.com.tw
asia.optoma.com



Hong Kong

Unit A, 27/F Dragon Centre,
79 Wing Hong Street,
Cheung Sha Wan,
Kowloon, Hong Kong

 +852-2396-8968
 +852-2370-1222
www.optoma.com.hk

China

5F, No. 1205, Kaixuan Rd.,
Changning District
Shanghai, 200052, China

 +86-21-62947376
 +86-21-62947375
www.optoma.com.cn

