

DLP® Projector

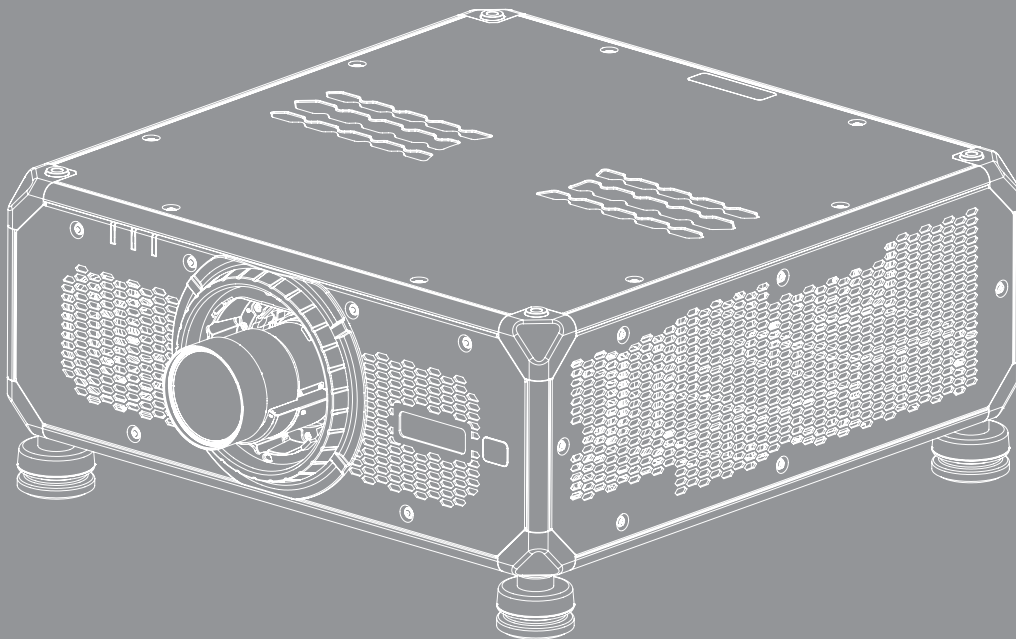

TABLE OF CONTENTS

SAFETY	5
<i>Important safety instructions</i>	5
<i>Light Intensity Hazard Distance</i>	6
<i>Laser radiation safety information</i>	6
<i>Product safety labels</i>	7
<i>Light beam related safety labels</i>	7
<i>Copyright</i>	8
<i>Disclaimer</i>	8
<i>Trademark recognition</i>	8
<i>FCC</i>	8
<i>Declaration of conformity for EU countries</i>	9
<i>WEEE</i>	9
INTRODUCTION	10
<i>Package overview</i>	10
<i>Standard accessories</i>	10
<i>Optional accessories</i>	10
<i>Product overview</i>	11
<i>Connections</i>	14
<i>Keypad</i>	15
<i>Remote control</i>	16
SETUP AND INSTALLATION	17
<i>Installing the projection lens</i>	17
<i>Adjusting the projector position</i>	18
<i>Hanging application</i>	19
<i>Boresight adjustment</i>	20
<i>Required tool</i>	20
<i>Setting the projector start mode</i>	20
<i>Performing the boresight adjustment</i>	20
<i>Connecting sources to the projector</i>	24
<i>Adjusting the projector image</i>	25
<i>Remote setup</i>	26
USING THE PROJECTOR	29
<i>Powering on / off the projector</i>	29
<i>Selecting an input source</i>	30
<i>Menu navigation and features</i>	31
<i>OSD menu tree</i>	32
<i>Image menu</i>	47
<i>Picture Mode</i>	47
<i>Dynamic Range</i>	48
<i>Brightness</i>	48



Contrast.....	48
Sharpness.....	48
Gamma.....	48
Dynamic Contrast.....	49
Color Settings.....	49
Wall Color.....	50
3D Setup.....	50
Save to User.....	52
Apply to User.....	52
Reset.....	52
Display menu.....	53
Aspect Ratio.....	53
Digital Zoom.....	53
Image Shift.....	53
Geometric Correction.....	54
Edge Mask.....	56
Freeze Screen.....	56
Test Pattern.....	56
PIP/PBP.....	56
Reset.....	57
Input Settings menu.....	58
Auto Source.....	58
Active Inputs.....	58
Latency Adjustment.....	58
Backup Input.....	58
VGA.....	59
HDMI.....	59
HDBaseT.....	59
Reset.....	59
Device Setup menu.....	60
Language.....	60
Projection.....	60
Lens Settings.....	60
Active Image Setup.....	61
Schedule.....	62
Date and Time.....	64
Power Settings.....	65
Light Source Settings.....	65
Shutter.....	66
Security.....	66
On Screen Display.....	66
Logo Setup.....	67
Backlight.....	67
High Altitude.....	67
User Data.....	67
System Update (FOTA).....	67
Reset.....	67
Communication menu.....	68
Projector ID.....	68
Remote Setup.....	68
Network Setup.....	69

<i>Email Notification</i>	69
<i>Control</i>	69
<i>Baud Rate</i>	70
<i>Reset</i>	70
<i>Using the web control panel</i>	71
<i>Using RS232 command by Telnet</i>	73
<i>Info menu</i>	73

ADDITIONAL INFORMATION..... 74

<i>Compatible resolutions</i>	74
<i>Image size and projection distance</i>	95
<i>Projector dimensions and ceiling mount installation</i>	98
<i>IR remote codes</i>	99
<i>Troubleshooting</i>	101
<i>LED status indicators</i>	102
<i>Specifications</i>	103
<i>Optoma global offices</i>	119
<i>RS232 protocol function list</i>	

SAFETY

	The lightning flash with arrow head within an equilateral triangle is intended to alert the user to the presence of uninsulated "dangerous voltage" within the product's enclosure that may be of sufficient magnitude to constitute a risk of electric shock to persons.
	The exclamation point within an equilateral triangle is intended to alert the user to the presence of important operating and maintenance (servicing) instructions in the literature accompanying the appliance.

Please follow all warnings, precautions and maintenance as recommended in this user manual.

Important safety instructions

- Do not block any ventilation openings. To ensure reliable operation of the projector and to protect from overheating, it is recommended to install the projector in a location that does not block ventilation. As an example, do not place the projector on a crowded surface. Do not put the projector in an enclosure such as a book case or a cabinet that restricts air flow.
- To reduce the risk of fire and/or electric shock, do not expose the projector to rain or moisture. Do not install near heat sources such as radiators, heaters, stoves or any other apparatus such as amplifiers that emits heat.
- Do not let objects or liquids enter the projector. They may touch dangerous voltage points and short out parts that could result in fire or electric shock.
- Do not use under the following conditions:
 - In extremely hot, cold or humid environments.
 - (i) Ensure that the ambient room temperature is within 0°C~50°C (32°F~122°F)
 - (ii) Relative humidity is 10% ~ 85%
 - In areas susceptible to excessive dust and dirt.
 - Near any appliance generating a strong magnetic field.
 - In direct sunlight.
- Do not use the unit if it has been physically damaged or abused. Physical damage/abuse would be (but not limited to):
 - Unit has been dropped.
 - Power supply cord or plug has been damaged.
 - Liquid has been spilled on to the projector.
 - Projector has been exposed to rain or moisture.
 - Something has fallen in the projector or something is loose inside.
- Do not place the projector on an unstable surface. The projector may fall over resulting in injury or the projector may become damaged.
- Do not block the light coming out of the projector lens when in operation. The light will heat the object and cause it to melt, burn or start a fire.
- Please do not open or disassemble the projector as this may cause electric shock.
- Do not attempt to service the unit yourself. Opening or removing covers may expose you to dangerous voltages or other hazards. Please call Optoma before you send the unit for repair.
- See projector enclosure for safety related markings.
- The unit should only be repaired by authorized service personnel.
- Only use attachments/accessories specified by the manufacturer.
- Do not look straight into the projector lens during operation. The bright light may harm your eyes.
- Turn off and unplug the power plug from the AC outlet before cleaning the product.
- Use a soft dry cloth with mild detergent to clean the projector housing. Do not use abrasive cleaners, waxes or solvents to clean the unit.

- Disconnect the power plug from the AC outlet if the product will not be used for a long period of time.
- Do not setup the projector in places where it might be subjected to vibration or shock.
- Do not touch the lens with bare hands.
- Do not clean the lens when the projector is turned on. Any damage resulting from doing so will void the warranty.
- Remove battery/batteries from remote control before storage. If the battery/batteries are left in the remote for long periods, they may leak.
- Do not use or store the projector in places where smoke from oil or cigarettes may be present, as it can adversely affect the quality of the projector performance.
- Please follow the correct projector orientation installation as non standard installation may affect the projector performance.
- Use a power strip and/or surge protector. As power outages and brown-outs can KILL devices.
- Warning: Do not remove the earthing pin on the mains plugs. This apparatus is equipped with a three prong earthing type mains plug. This plug will only fit an earthing-type mains socket. This is a safety feature. If you are unable to insert the plug into the mains socket, contact an electrician.
- Caution: This equipment is equipped with a three-pin grounding-type power plug. Do not remove the grounding pin on the power plug. This plug will only fit a grounding-type power outlet. This is a safety feature. If you are unable to insert the plug into the outlet, contact an electrician.

Light Intensity Hazard Distance

This product is classified as CLASS 1 LASER PRODUCT - RISK GROUP 2 of IEC 60825-1 : 2014 and also complies with 21 CFR 1040.10 and 1040.11 except for conformance as a Risk Group 2 LIP as defined in IEC 62471-5:Ed. 1.0. For more information, see Laser Notice No. 57, dated May 8, 2019.

When set up with A22, A23 and A27 lens (throw ratio greater than 2.0), this projector may become Class 1 Laser Product-Risk Group 3 (RG3); with other lens (throw ratio less than 2.0), this projector may become Class 1 Laser Product-Risk Group 2 (RG2) according to IEC 60825-1:2014 and IEC 62471-5: 2015, and also make a variance approvals under 21 CFR 1010.4 for RG3 LIP according to Classification and Requirements for Laser Illuminated Projectors (LIPs) (Laser Notice No. 57).

Projection Lens	Throw Ratio	Classification and Requirements for Laser Illuminated Projectors (LIPs)	
• A11	• 0.65-0.75	• HD: N/A	<ul style="list-style-type: none"> • IEC 62471-5: 2015 • IEC 60825-1: 2014 • CLASS 1 LASER PRODUCT RISK GROUP 2
• A18	• 0.84-1.02		
• A19	• 1.02-1.36		
• A20	• 1.2-1.5		
• A21	• 1.5-2.0		

Projection Lens	Throw Ratio	Classification and Requirements for Laser Illuminated Projectors (LIPs)	
• A22	• 2.0-4.0	• HD:1.165 meters	<ul style="list-style-type: none"> • IEC 62471-5: 2015 • IEC 60825-1: 2014 • CLASS 1 LASER PRODUCT RISK GROUP 3
• A23	• 4.0-7.2	• HD:4.12 meters	
• A27	• 7.2-10.8	• HD:6.4 meters	

Laser radiation safety information

To ensure safe operation, read all laser safety precautions before installing and operating the projector.

- This projector is class 1 laser product of IEC/EN 60825-1:2014 and risk group 2 with the requirements of IEC 62471-5:2015.
- This projector uses extremely high brightness laser. Do not stare directly into the light beam, as the extremely high brightness may cause permanent eye damage. (Risk Group 2 of IEC 62471-5:2015).
- No direct exposure to the beam shall be permitted. (Risk Group 3 of IEC 62471-5:2015).
- This product is not for household use.
- Possibly hazardous optical radiation emitted from this product.
- This projector has a built-in Class 4 laser module. Never attempt to disassemble or modify the laser module.

- Any operation or adjustment not specifically instructed in the User manual creates the risk of hazardous laser radiation exposure.
- Do not stare into beam when the projector is on. When turning on the projector, make sure no one within projection range is looking into the lens.
- Follow the control, adjustment, or operation procedures to avoid damage or injury from exposure to laser radiation.
- The instructions for the assembly, operation, and maintenance include clear warnings to avoid possible exposure to hazardous laser radiation.
- We recommend you install this projector above the reach of children.
- Notice is given to supervise children and to never allow them to stare into the projector beam at any distance from the projector.
- Notice is given to use caution when using the remote control for starting the projector while in front of the projection lens.
- Notice is given to the user to avoid the use of optical aids such as binoculars or telescopes inside the beam.

Product safety labels

Light beam related safety labels

Label image

Label description

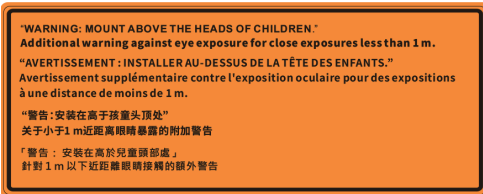

“WARNING: MOUNT ABOVE THE REACH AND SIGHT OF CHILDREN.”
The use of a ceiling mount is recommended with this product to place it above the eye level of children.
Additional warning against eye exposure for close exposures less than 1 m.

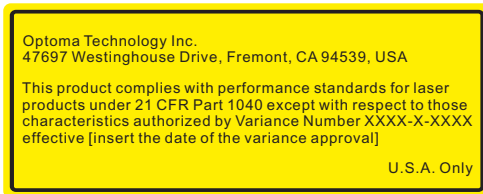

FDA laser variance (US projectors only)

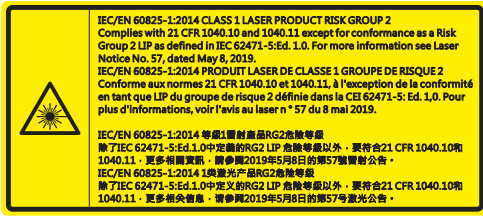

This product is classified as Class 1 Laser Product-Risk Group 2 of IEC 60825-1:2014 and also complies with 21 CFR 1040.10 and 1040.11 as a Risk Group 2, LIP (Laser Illuminated Projector) as defined in IEC 62471-5:Ed.1.0. For more information, see Laser Notice No. 57, dated May 8, 2019.



This projector may become Risk Group 3 product when an interchangeable lens with throw ratio greater than 2.0 is installed. Refer to the manual for the lens list and hazard distance before operation. Such combinations of projector and lens are intended for professional use only, and are not intended for consumer use.
Not for household use.
No direct exposure to beam shall be permitted, which can cause injury to the retina in the back of the eye.
As with any bright light source, do not stare into the beam, RG2 IEC 62471-5:2015

Copyright

This publication, including all photographs, illustrations and software, is protected under international copyright laws, with all rights reserved. Neither this manual, nor any of the material contained herein, may be reproduced without written consent of the author.

© Copyright 2021

Disclaimer

The information in this document is subject to change without notice. The manufacturer makes no representations or warranties with respect to the contents hereof and specifically disclaims any implied warranties of merchantability or fitness for any particular purpose. The manufacturer reserves the right to revise this publication and to make changes from time to time in the content hereof without obligation of the manufacturer to notify any person of such revision or changes.

Trademark recognition

Kensington is a U.S. registered trademark of ACCO Brand Corporation with issued registrations and pending applications in other countries throughout the world.

HDMI, the HDMI Logo, and High-Definition Multimedia Interface are trademarks or registered trademarks of HDMI Licensing LLC in the United States and other countries.

DLP®, DLP Link and the DLP logo are registered trademarks of Texas Instruments and BrilliantColor™ is a trademark of Texas Instruments.

HDBaseT™ and the HDBaseT Alliance logo are trademarks of the HDBaseT Alliance.

All other product names used in this manual are the properties of their respective owners and are Acknowledged.

FCC

This device has been tested and found to comply with the limits for a Class A digital device pursuant to Part 15 of the FCC rules. These limits are designed to provide reasonable protection against harmful interference in a residential installation. This device generates, uses and can radiate radio frequency energy and, if not installed and used in accordance with the instructions, may cause harmful interference to radio communications.

However, there is no guarantee that interference will not occur in a particular installation. If this device does cause harmful interference to radio or television reception, which can be determined by turning the device off and on is encouraged to try to correct the interference by one or more of the following measures:

- Reorient or relocate the receiving antenna.
- Increase the separation between the device and receiver.
- Connect the device into an outlet on a circuit different from that to which the receiver is connected.
- Consult the dealer or an experienced radio/television technician for help.

Notice: Shielded cables

All connections to other computing devices must be made using shielded cables to maintain compliance with FCC regulations.

Caution

Changes or modifications not expressly approved by the manufacturer could void the user's authority, which is granted by the Federal Communications Commission, to operate this projector.

Operation conditions

This device complies with Part 15 of the FCC Rules. Operation is subject to the following two conditions:

1. This device may not cause harmful interference and
2. This device must accept any interference received, including interference that may cause undesired operation.

Notice: Canadian users

This Class A digital apparatus complies with Canadian ICES-003.

Remarque à l'intention des utilisateurs canadiens

Cet appareil numérique de la classe A est conforme à la norme NMB-003 du Canada.

Declaration of conformity for EU countries

- EMC Directive 2014/30/EU (including amendments)
- Low Voltage Directive 2014/35/EU
- Radio Equipment Directive 2014/53/EU (if product has RF function)
- RoHS Directive 2011/65/EU

WEEE



Disposal instructions

Do not throw this electronic device into the trash when discarding. To minimize pollution and ensure utmost protection of the global environment, please recycle it.

INTRODUCTION

Package overview

Carefully unpack and verify that the projector comes with all the standard accessories shown below. Some accessories may not be available depending on the projector model, specification and your region of purchase. The warranty card is only supplied in specific regions. Please check with your place of purchase or consult your dealer for more information.

Standard accessories

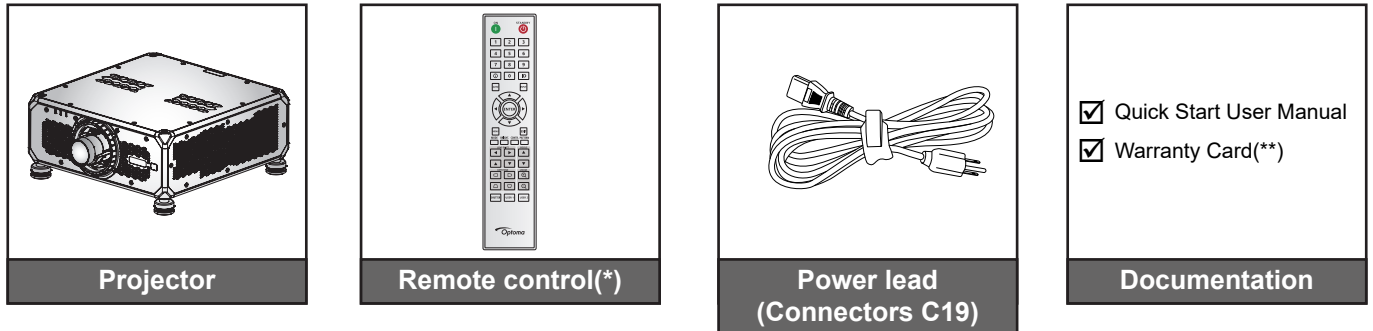

Note:

- (*)The remote control requires two AAA batteries. See *Installing/replacing the batteries* on page 26 for more information.
- (**) For European warranty Information, please visit www.optoma.com.



Please scan the OPAM warranty QR code or visit the following URL:
<https://www.optoma.com/us/support/warranty-and-return-policy/>



Please scan the QR code or visit the following URL: <https://www.optoma.com/support/download>

Optional accessories

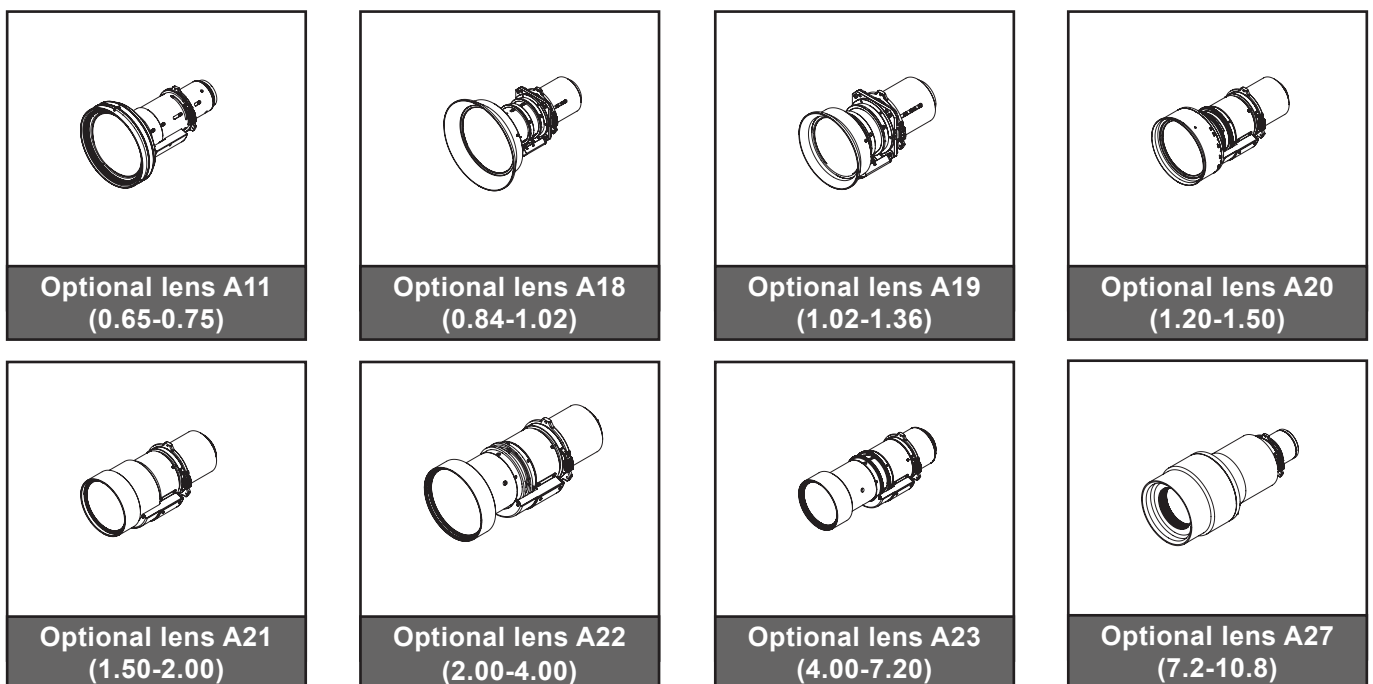

Note: The accessories may vary depending on model, specification and region.

INTRODUCTION

Product overview

Front view

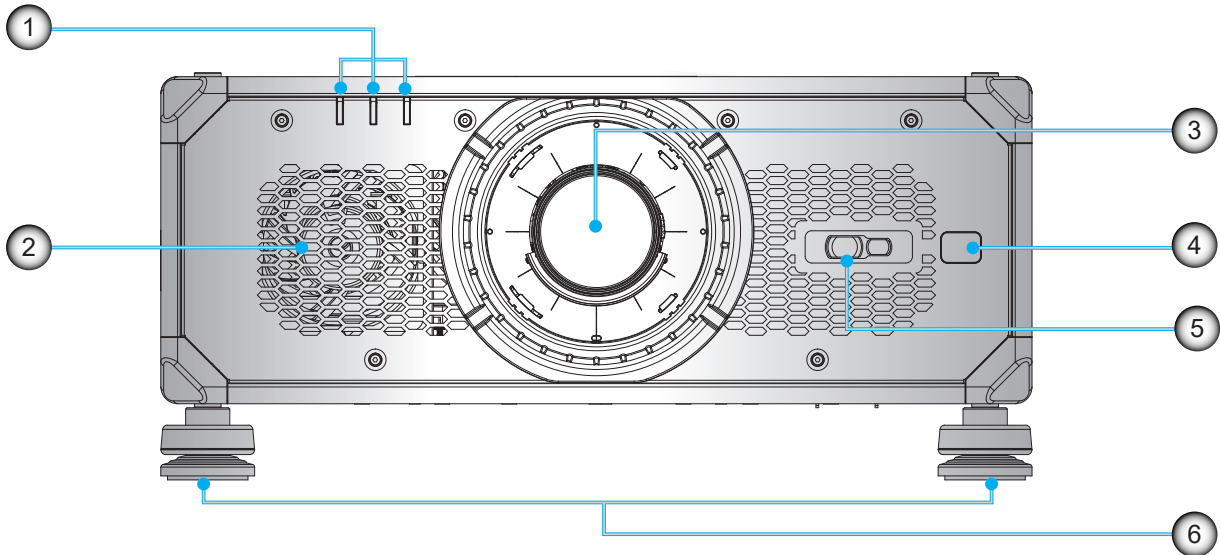

No	Item	No	Item
1.	Status LED	4.	Front IR sensor
2.	Cooling air vents (intake)	5.	Camera window
3.	Projection lens	6.	Adjustment feet

Rear view

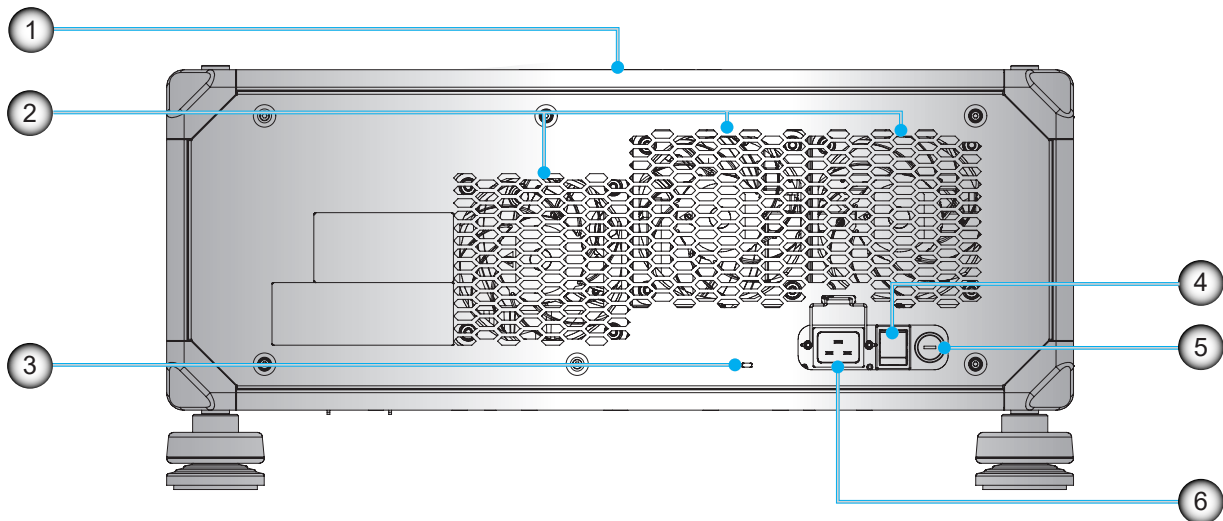

No	Item	No	Item
1.	Top IR sensor	4.	Power switch
2.	Cooling air vents (exhaust)	5.	Fuse
3.	Kensington lock	6.	AC input (C20 inlets)

INTRODUCTION

Bottom view

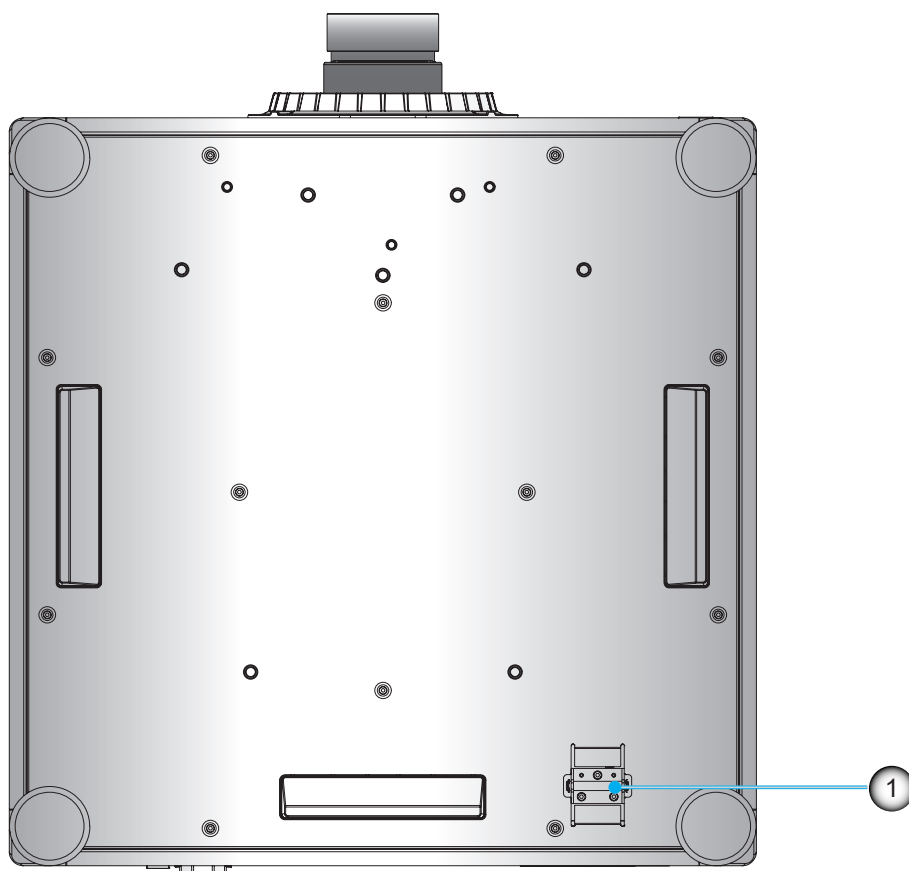

No	Item
1.	Security bar

INTRODUCTION

Side view

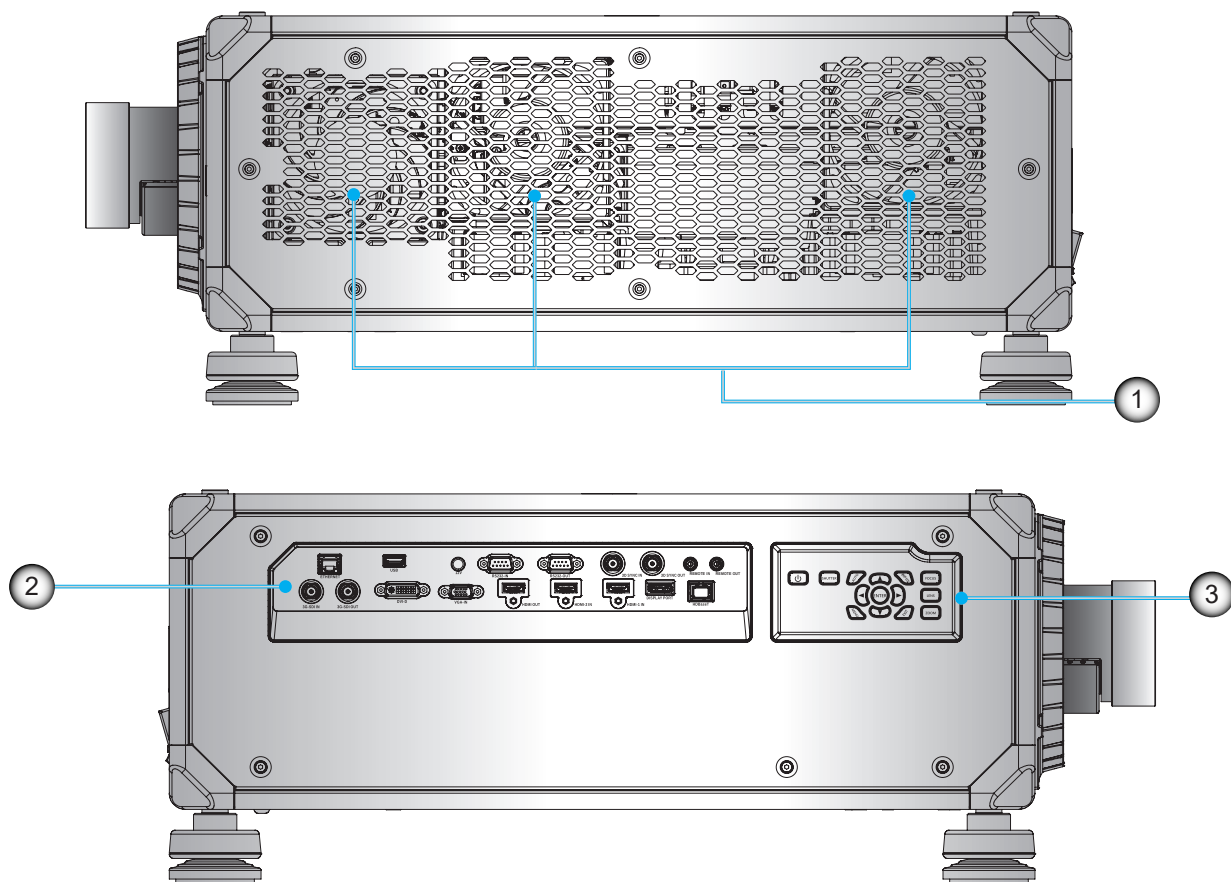

No	Item	No	Item
1.	Cooling air vents (intake)	3.	Built-in keypad
2.	Input/Output (I/O) panel		

Note: Do not block projector intake or outlet air vents.

INTRODUCTION

Connections

Side I/O panel

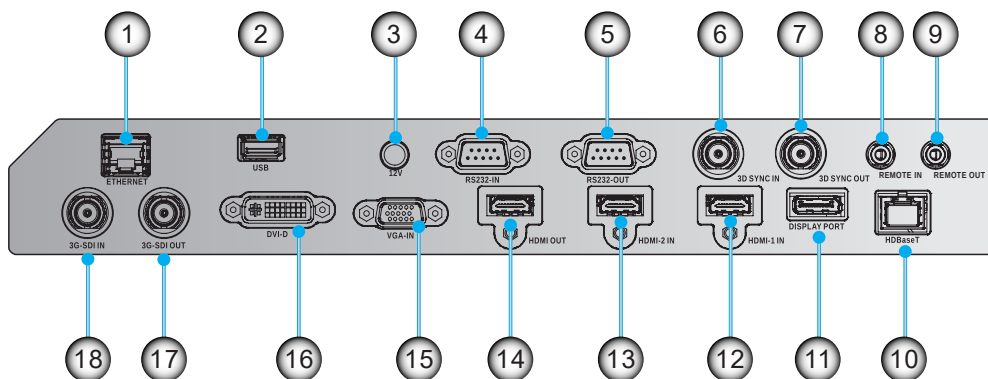

No	Item	No	Item
1.	ETHERNET	10.	HDBaseT
2.	USB	11.	DISPLAYPORT
3.	12V	12.	HDMI-1 IN
4.	RS232-IN	13.	HDMI-2 IN
5.	RS232-OUT	14.	HDMI OUT
6.	3D SYNC IN	15.	VGA-IN
7.	3D SYNC OUT	16.	DVI-D
8.	REMOTE IN	17.	3G-SDI OUT
9.	REMOTE OUT	18.	3G-SDI IN

Note: The USB port is for power (5V; 0.5A) delivery only.

INTRODUCTION

Keypad

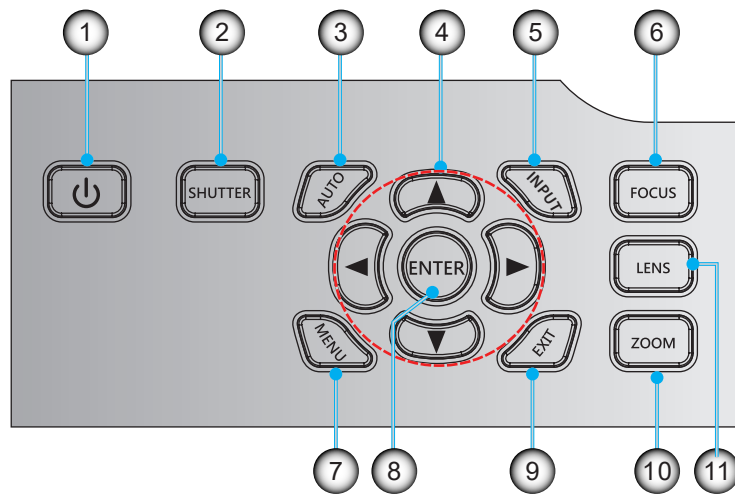

No	Item	No	Item
1.	Power key	7.	MENU
2.	SHUTTER	8.	ENTER
3.	AUTO	9.	EXIT
4.	Arrow keys	10.	ZOOM
5.	INPUT	11.	LENS
6.	FOCUS		

INTRODUCTION

Remote control

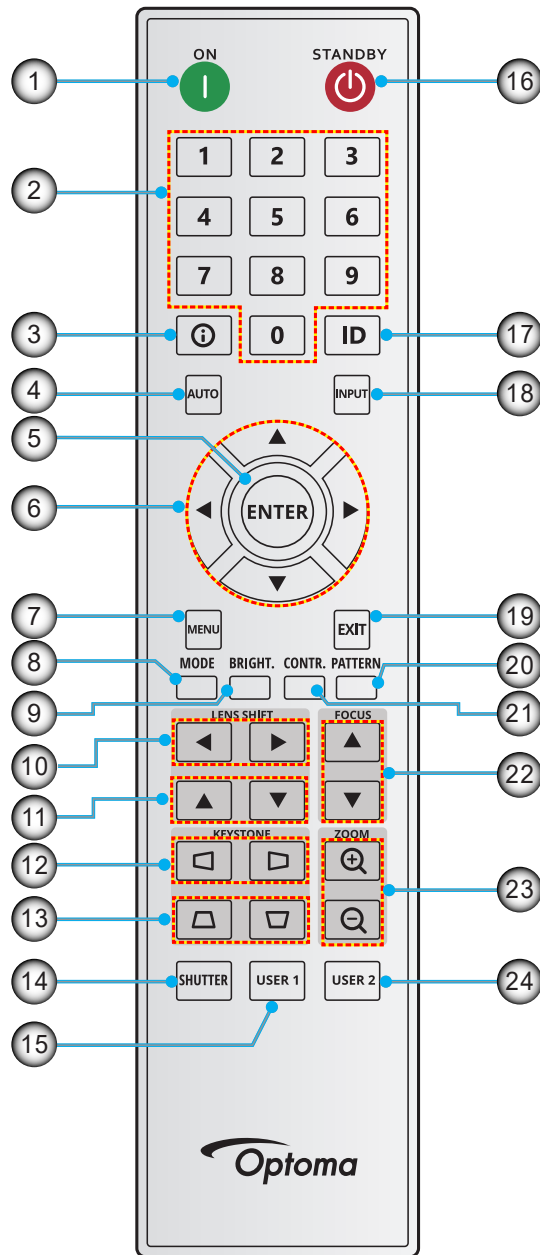

No	Item	No	Item	No	Item
1.	Power On	9.	Bright. (brightness)	17.	ID
2.	Number Keys	10.	Left Shift (horizontal)	18.	Input
3.	Info	11.	Left Shift (vertical)	19.	Exit
4.	Auto	12.	Keystone (horizontal)	20.	Pattern
5.	Enter	13.	Keystone (vertical)	21.	Contr. (Contrast)
6.	Arrow Keys	14.	Shutter	22.	Focus
7.	Menu	15.	User 1	23.	Zoom In/Zoom Out
8.	Mode	16.	Standby	24.	User 2

SETUP AND INSTALLATION

Installing the projection lens

Before setting up the projector, install the projection lens in to the projector.

在安装或替换镜头前，关掉投影机的电源。

在镜头安装联接过程中，避免使用遥控器或投影机按键板的按钮调节侧平移镜头或缩放/聚焦。

Before installing or replacing the lens, switch off the power to the projector.

Avoid using the remote control or projector keypad button to adjust the lens shift or zoom/focus while the lens attachment process is carried out.

IMPORTANT!

- Before installing or replacing the lens, make sure the projector's power switch is turned off.
- During lens installation, do not adjust the lens shift, zoom, or focus either using the remote control or the projector keypad.
- To prevent damage to the lens and avoid personal injury, do not clean the lens when the projector is turned on. Any damage resulting from doing so will void the warranty.

Procedure:

1. Rotate the lens cap counterclockwise and then remove it from the projector.

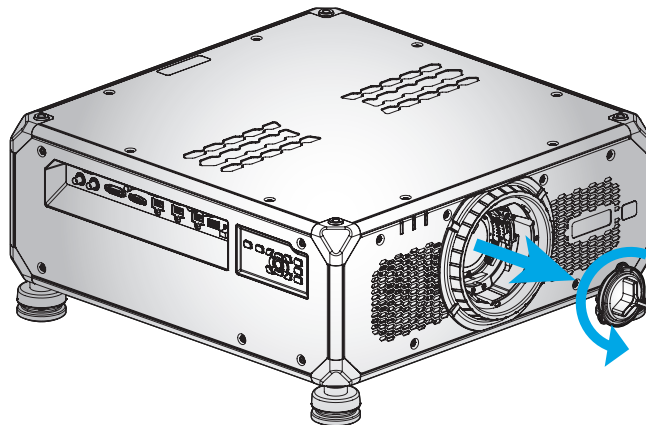

2. Insert the lens to the projector. Then rotate the lens clockwise to lock the lens in place.

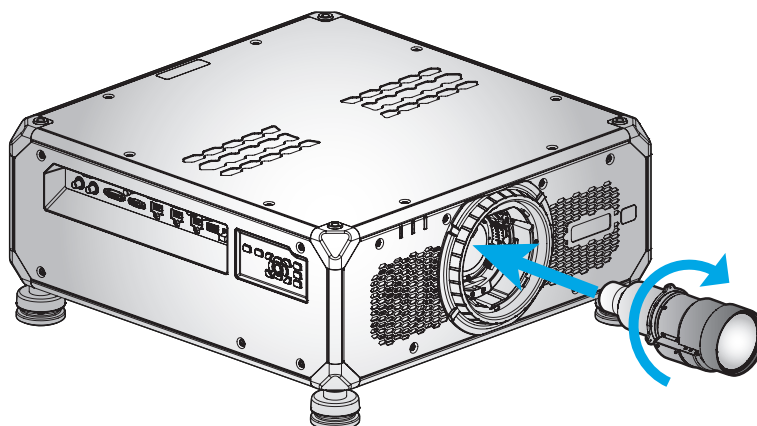

SETUP AND INSTALLATION

Adjusting the projector position

When you select a position for the projector, consider the size and shape of your screen, the location of your power outlets, and the distance between the projector and the rest of your equipment. Follow these general guidelines:

- Position the projector on a flat surface at a right angle to the screen.
- Position the projector to the desired distance from the screen. The distance from the lens of the projector to the screen, the zoom setting, and the video format determine the size of the projected image.
- 360 degree free orientation operation

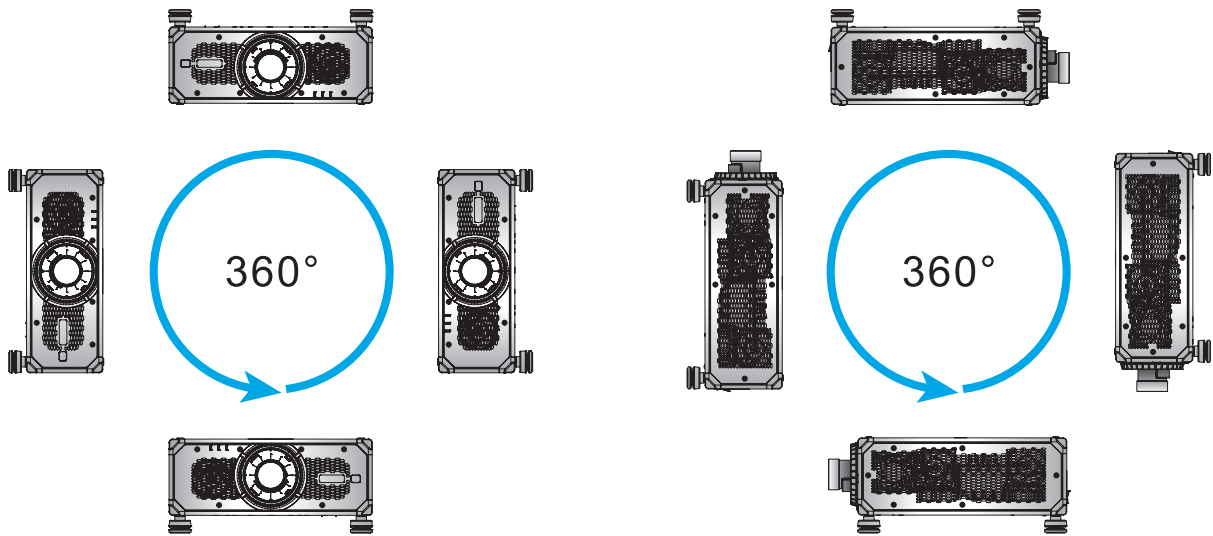

- For ceiling mount installations, make sure to leave 10 mm (0.4") between the ceiling mount and the bottom intake vents of the projector.

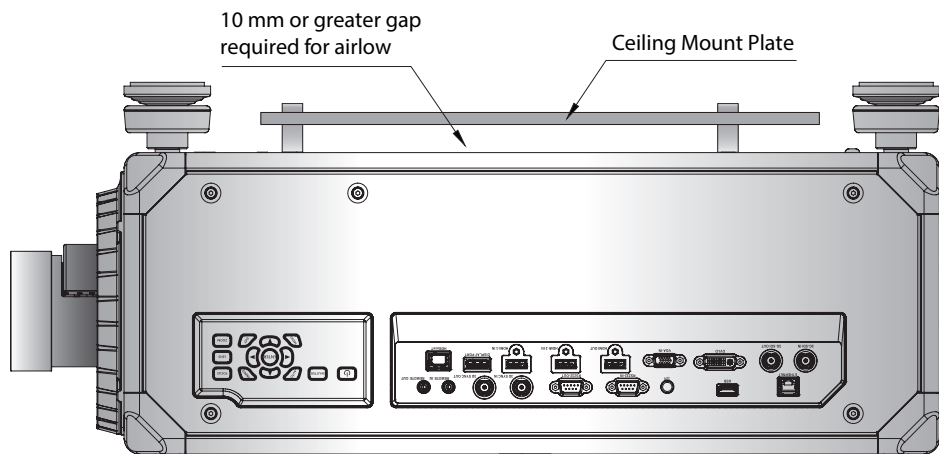

SETUP AND INSTALLATION

- Allowing proper space around the projector is critical for air circulation and cooling. For 360° installations and multiple projectors, make sure to leave at least 600mm (23.6") space around the air intakes and outlet of the projector.

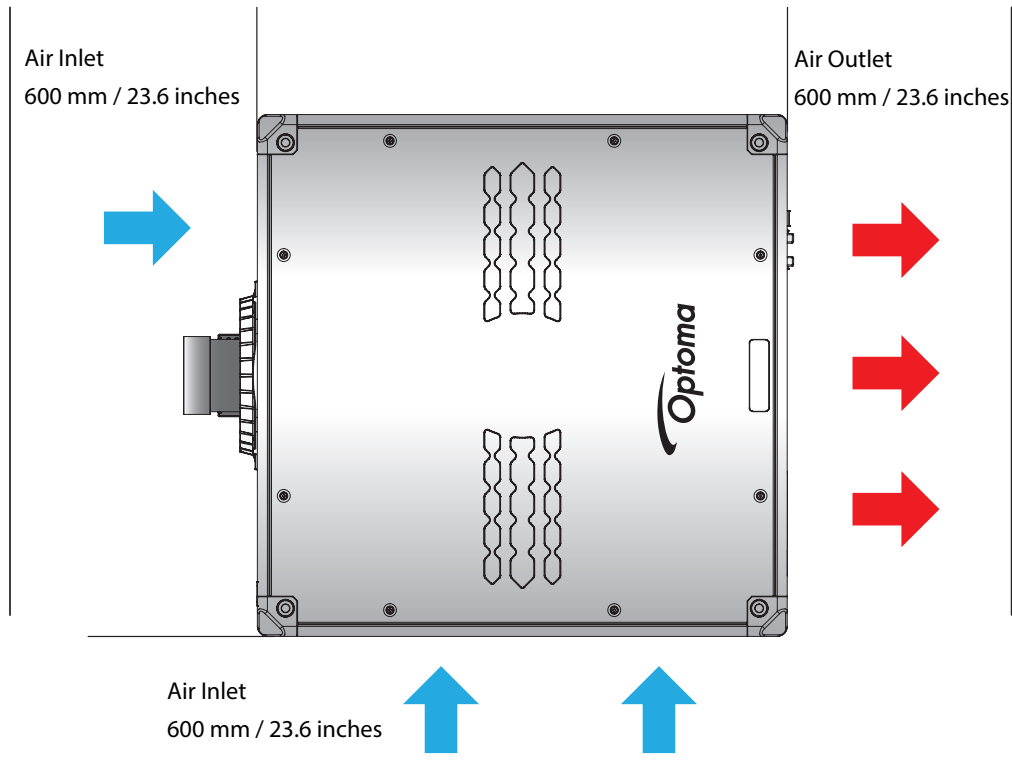

Hanging application

For hanging application, attach four eyebolts to the designated locations on the projector as shown below. Then use the adjustable wires to hang the projector on the ceiling. For more information on hanging application, please contact the vendor. Screw type: M10*P1.5*L20mm x 4.

IMPORTANT! To avoid damage to the projector, use one hanging application to hang a single projector only.

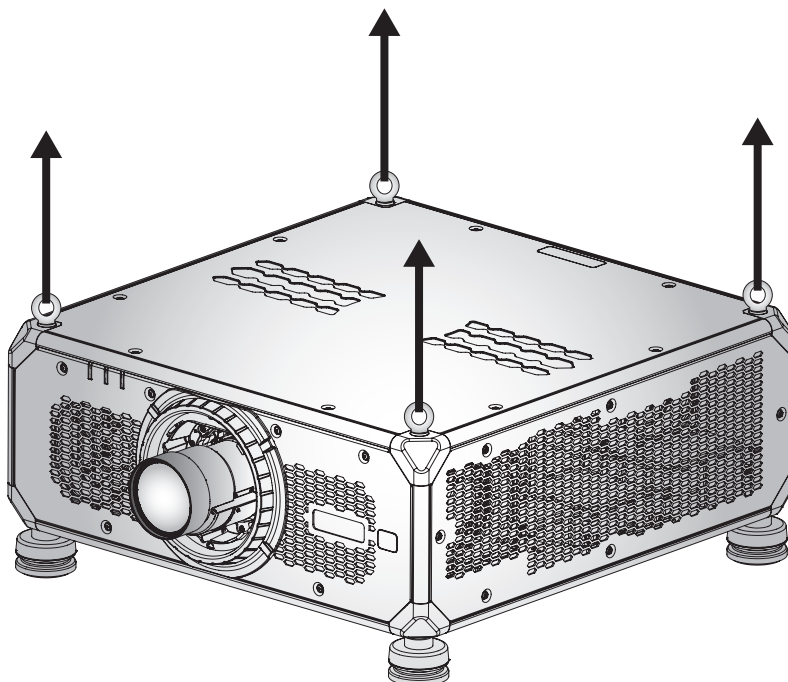

SETUP AND INSTALLATION

Boresight adjustment

Only apply a boresight adjustment in case the overall focus of the projected image is not equally sharp. The boresight adjustment helps to balance the tilt of the lens mount to sharpen the unfocused sections of the image. It tilts the lens holder to parallel the lens plane and the DMD plane.

Note: *This boresight adjustment process may cause the other areas of the image to slide out of focus. This is totally normal.*

Required tool

The following tools are required for boresight adjustment:

- Allen key, hex 4mm

For A11/A18/A27 lens, the following tools are required:

- Boresight extender with red rubber ring
- L-shape socket tool

Setting the projector start mode

1. Choose the test pattern of the OSD. Switch to full screen mode.
2. Prepare the test area. Verify that the throw ratio of the installed lens matches the requirements of the installation area (projection distance and screen size).
3. Check that the lens is correctly installed.

Performing the boresight adjustment

Use the Allen key screwdriver to clockwise or counter-clockwise adjust the three boresight screws.

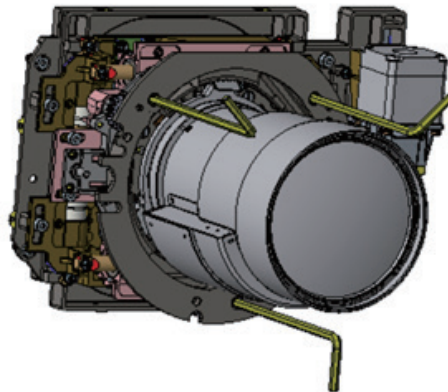

For A11/A18/A27 lens

The boresight extenders must be installed before installing the A11/A27/A18 lens.

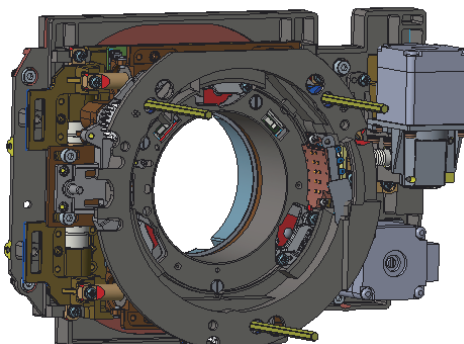

SETUP AND INSTALLATION

1. Use the L-shape screwdriver to adjust the three boresight screws.

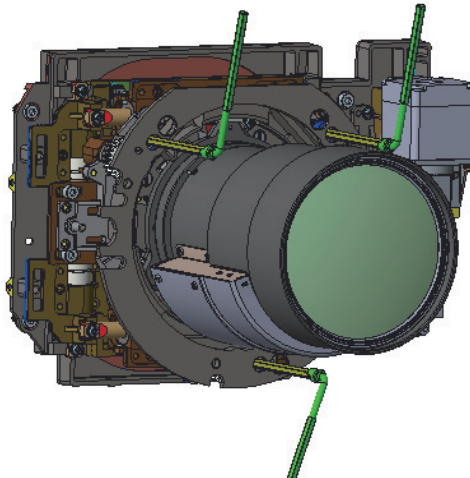

2. Zoom the lens to its widest opening.
3. Adjust the focus control to search for the best sharpness of the projected image.
4. Zone A/C boresight adjustment.

If zone A is in focus on the screen, please check the focal plane of zone C.

- If clear position is just on the screen then no need to adjust.
- If clear position is out of the screen (Close to the projector), rotate screw ① CCW and then screw ② & ③ CW for half amount that ① rotated. Then repeat until both A and C are clear. For example, turn ① CCW in a circle, then turn ② & ③ CW in half circle).
- If clear position is in the screen (away from the projector), rotate screw ① CW and then screw ② & ③ CCW for half amount that ① rotated. Then repeat until both A and C are clear.

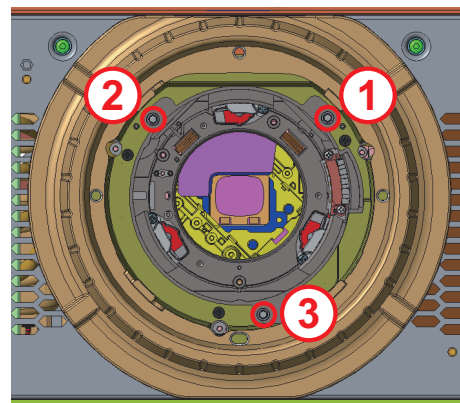
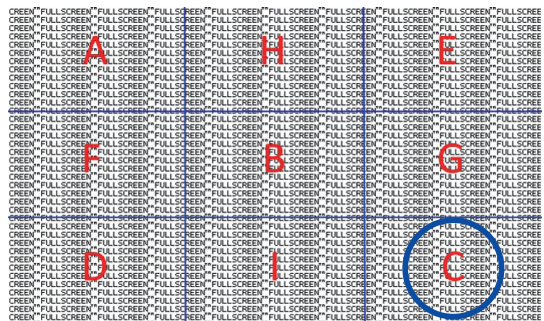
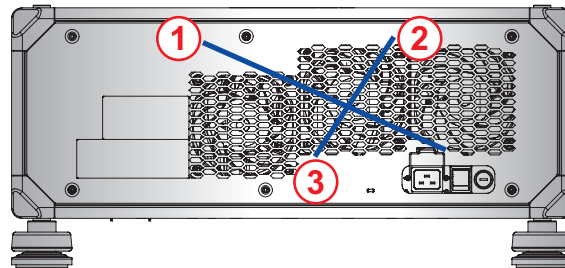

SETUP AND INSTALLATION

5. Zone D/E boresight adjustment.

If zone E is in focus on the screen, please check the focal plane of zone D.

- If clear position is just on the screen then no need to adjust.
- If clear position is out of the screen (close to the projector), rotate screw ② CCW and then screw ① & ③ CW for half amount that ② rotated. Then repeat until both D and E are clear. For example, turn ② CCW in a circle, then turn ① & ③ CW in half circle).
- If clear position is in the screen (away from the projector), rotate screw ② CW and then screw ① & ③ CCW for half amount that ② rotated. Then repeat until both D and E are clear.

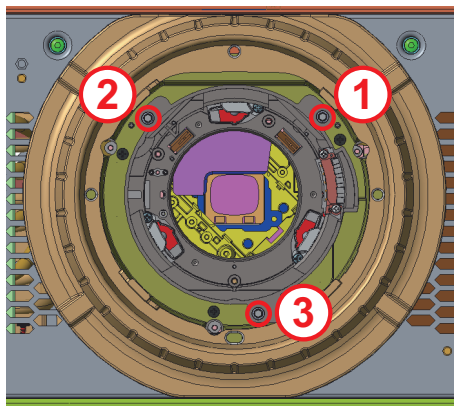
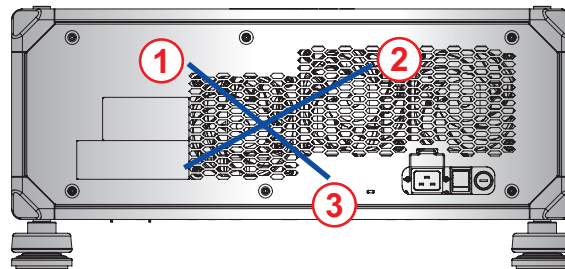
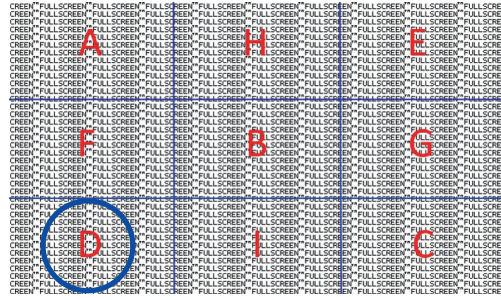

6. Zone H/I boresight adjustment.

If zone I is in focus on the screen, please check the focal plane of zone H.

- If clear position is just on the screen then no need to adjust.
- If clear position is out of the screen (close to the projector), rotate screw ③ CCW and then screw ① & ② CW for half amount that ③ rotated. Then repeat until both H and I are clear. For example, turn ③ CCW in a circle, then turn ① & ② CW in half circle).
- If clear position is in the screen (away from the projector), rotate screw ③ CW and then screw ① & ② CCW for half amount that ③ rotated. Then repeat until both H and I are clear.

SETUP AND INSTALLATION

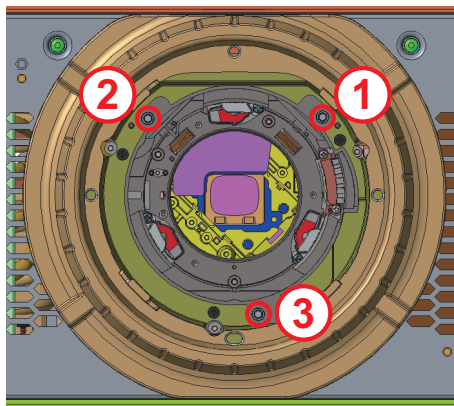
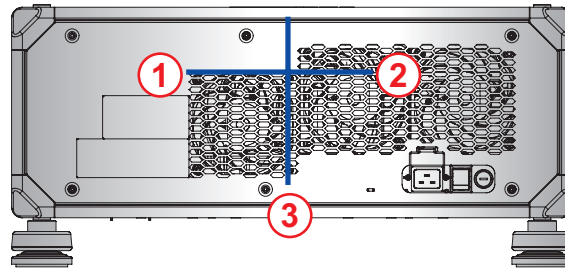
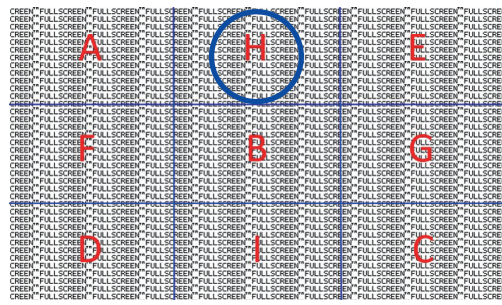

- After the above adjustment of the viewing axis, the projected image from zone A to zone I still cannot achieve a clear focus on the screen. Please remove the PJ-lens then turn the boresight screws ① to ③ counterclockwise to the end (STOP), and then turn clockwise 2 circles to the design value position.

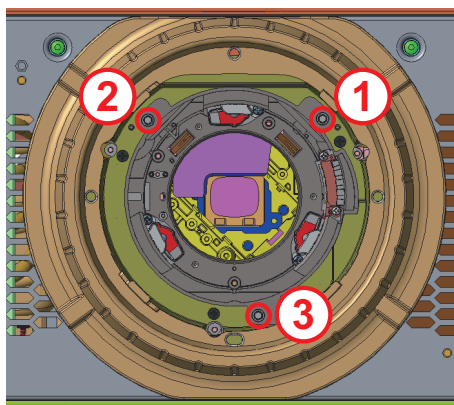

- Repeat steps 2 to 6 above to adjust.

SETUP AND INSTALLATION

Connecting sources to the projector

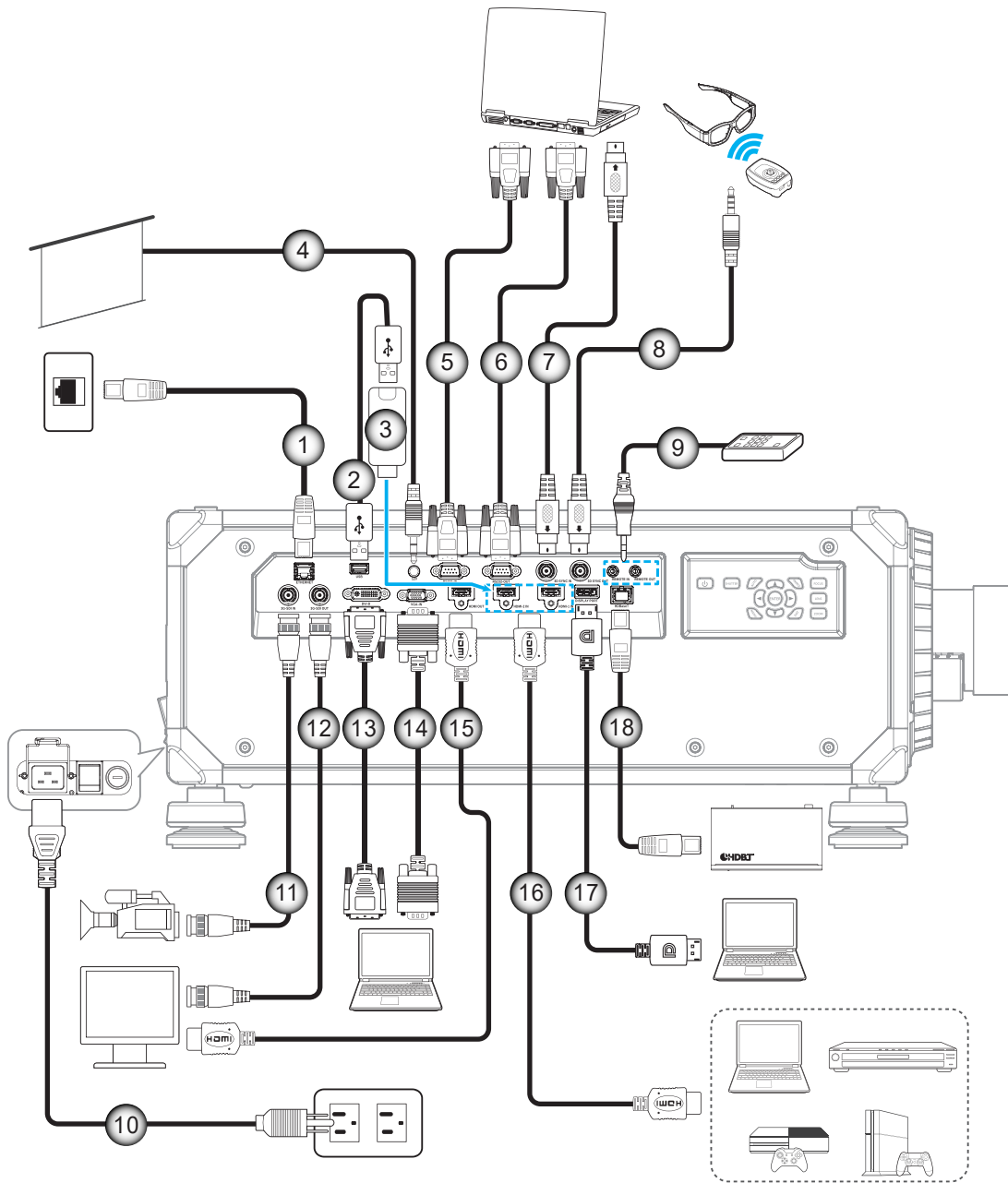

No	Item	No	Item
1.	RJ-45 Cable	10.	Power Cord
2.	USB Power Cable	11.	3G-SDI Cable
3.	HDMI Dongle	12.	3G-SDI Cable
4.	12V Trigger Cable	13.	DVI-D Cable
5.	RS-232 Cable	14.	VGA Cable
6.	RS-232 Cable	15.	HDMI Cable
7.	3D Sync Cable	16.	HDMI Cable
8.	3D Emitter Cable	17.	DisplayPort Cable
9.	Wired Remote-In/Out Cable	18.	RJ-45 Cable

SETUP AND INSTALLATION

RS232 Pin assignments

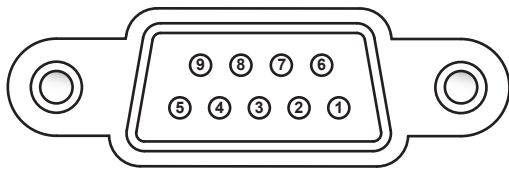

Pin No.	Signal	Pin No.	Signal
1	N/A	6	N/A
2	RXD	7	N/A
3	TXD	8	N/A
4	N/A	9	N/A
5	GND		

Adjusting the projector image

Image height

The projector is equipped with adjustable feet to change the image height.

1. Locate the adjustable foot you wish to adjust on the underside of the projector.
2. Rotate the adjustable foot clockwise or counterclockwise to raise or lower the projector.

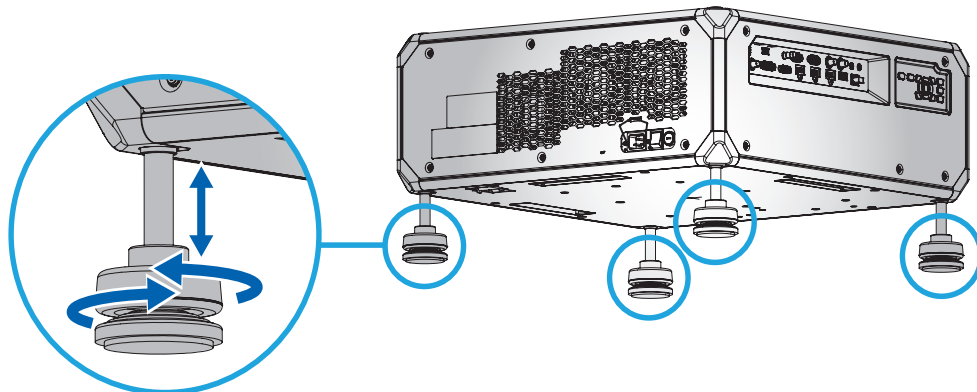

Note: The adjustable feet can be raised up to 50mm, or may be removed for certain installations. Please ensure sufficient space around projector for proper air flow.

Zoom and Focus

Use the remote control or projector keypad to adjust the zoom and focus of the projected image.

- To adjust the image focus, press **Focus** and the ▲▼ buttons to improve the image quality. (A)
- To adjust the image size, press **Zoom** and the ⊕⊖ buttons to get the required image size. (B)

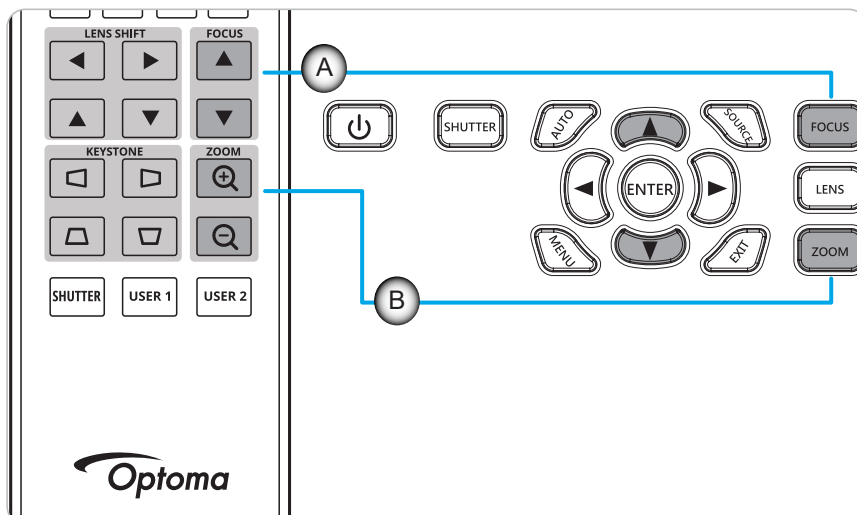

SETUP AND INSTALLATION

Remote setup

Installing / replacing the batteries

Two AAA size batteries are supplied for the remote control.

1. Remove the battery cover on the back of the remote control.
2. Insert AAA batteries in the battery compartment as illustrated.
3. Replace back cover on remote control.

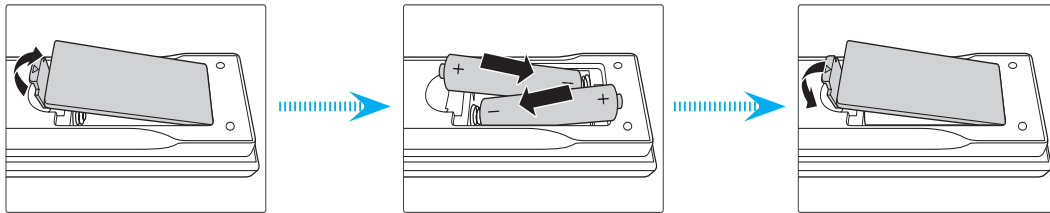

Note: Replace only with the same or equivalent type batteries.

CAUTION

Improper use of batteries can result in chemical leakage or explosion. Be sure to follow the instructions below.

- Do not mix batteries of different types. Different types of batteries have different characteristics.
- Do not mix old and new batteries. Mixing old and new batteries can shorten the life of new batteries or cause chemical leakage in old batteries.
- Remove batteries as soon as they are depleted. Chemicals that leak from batteries that come in contact with skin can cause a rash. If you find any chemical leakage, wipe thoroughly with a cloth.
- The batteries supplied with this product may have a shorter life expectancy due to storage conditions.
- If you will not be using the remote control for an extended period of time, remove the batteries.
- When you dispose of the batteries, you must obey the law in the relative area or country.

Remote control ID setup

The Infra-Red (IR) remote control supports individual addressing of projectors. The remote receiver on the projector can be set with a specific number from 00 to 99, and the projector only responds to the IR remote set to the same number. The default ID code of the IR remote is 00, allowing it to control all projectors within its effective range.

Follow below methods to set up the ID code for the IR remote control:

ID Code	Change method	Customer code
01	Press the ID button for 3 seconds, and press 0 then 1 within 2 seconds.	3201
02	Press the ID button for 3 seconds, and press 0 then 2 within 2 seconds.	3202
03	Press the ID button for 3 seconds, and press 0 then 3 within 2 seconds.	3203
...
10	Press the ID button for 3 seconds, and press 1 then 0 within 2 seconds.	3210
11	Press the ID button for 3 seconds, and press 1 then 1 within 2 seconds.	3211
...
98	Press the ID button for 3 seconds, and press 9 then 8 within 2 seconds.	3298
99	Press the ID button for 3 seconds, and press 9 then 9 within 2 seconds.	3299

To have the IR remote control return to default value 00 where all projectors can be controlled, press the **ID button** for 3 seconds, and press **0** twice within 2 seconds.

For more information on setting the remote receivers on the projector, refer to “Remote Setup” on page 68.

SETUP AND INSTALLATION

Effective range

The Infra-Red (IR) remote control sensors are located on the front and top sides of the projector. To have the remote control function correctly, be sure to hold the remote control at an angle of $\pm 30^\circ$ horizontally or angle of $\pm 20^\circ$ vertically within the distance of 20m (65.6 ft) or at an angle of 0° within the distance of 30m (98.4 ft) to the projector's IR remote control sensor.

- Make sure that there are no obstacles between the remote control and the IR sensor on the projector.
- Make sure the IR transmitter of the remote control is not being obstructed by direct light from sunlight or fluorescent lamps.
- Keep the remote control away from fluorescent lamps for at least 2m or it may malfunction.
- If the remote control is near Inverter-Type fluorescent lamps, it may operate ineffectively at times.
- If the remote control and the projector are within a very short distance, it may operate ineffectively.
- When aiming at a screen, the effective distance is less than 5m from the remote control to the screen and reflects the IR beams back to the projector. However, the effective range may vary between screens.

IMPORTANT! If you want to use the 3D IR emitter, refer to "IR Control setup when using the 3D IR emitter" on page 51.

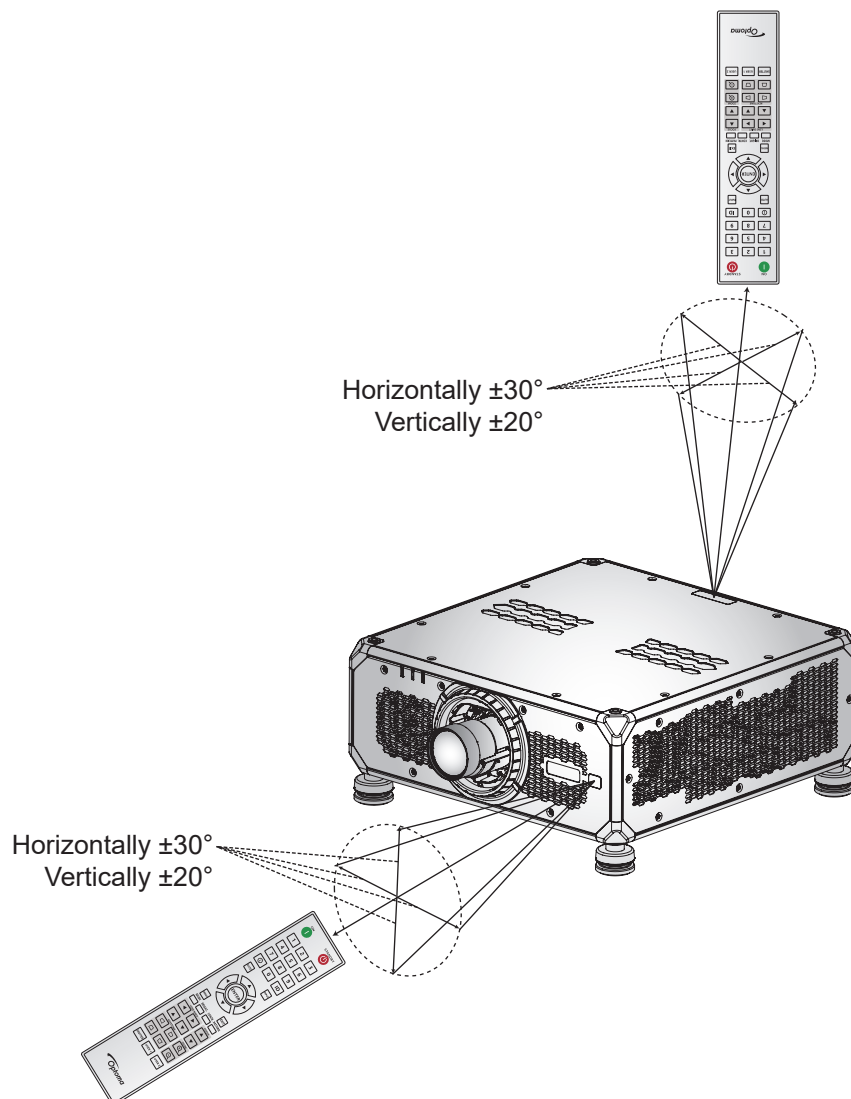

SETUP AND INSTALLATION

Wired remote

Remote In connector is designed to work with Wired Remote or IR Keypad with longer range and provides fast, easy set-up and reliable individual control of a specific projector. Remote Out connector sends the IR control signal to the next projector when using multiple projectors.

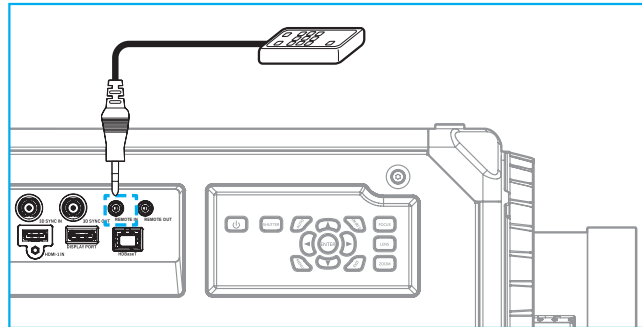

The connector type is 3.5mm Phone Jack connector:

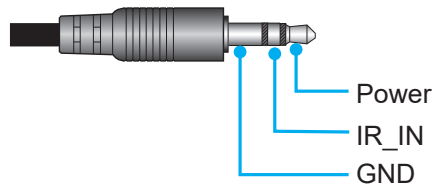

USING THE PROJECTOR

Powering on / off the projector

Powering on

1. Securely connect the AC power cord and signal/source cable to the projector.
2. Set the power switch to the "I" (ON) position and wait until the power button "⏻" on the projector keypad is solid orange.
3. Turn on the projector by pressing the ON button "I" on the remote control or the power button "⏻" on the projector keypad.

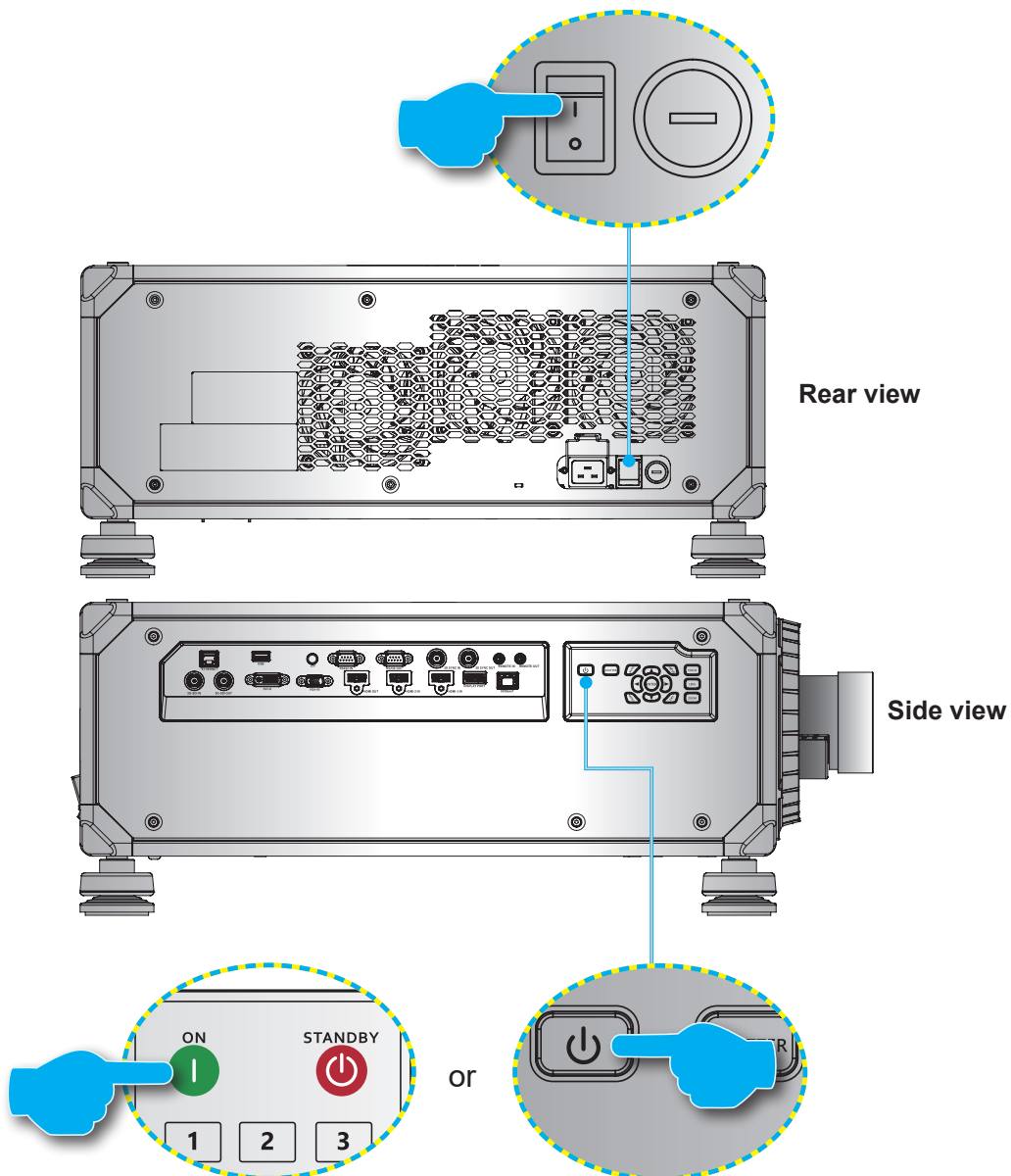

The status LED is orange with a long blink and the status LED will turn to solid green.



Note: If the projector is turned on for the first time, you will be prompted to select the projector language, projection orientation, and other settings.

USING THE PROJECTOR

Powering off

1. Turn off the projector by pressing the power button “” on the projector keypad or the **OFF** button “” on the remote control.
A message will pop up to confirm that you want to turn off the projector.
2. Press the power button or the **OFF** button again to confirm, otherwise the warning message disappears after 10 seconds and the projector remains on.
3. Set the Power switch to the “” (OFF) position.
The status LED turns from blinking orange to solid orange and the keypad also turns to solid orange.
4. Disconnect the power cord from both the projector and the electrical outlet.

Note: *It is not recommended to turn on the projector immediately after powering it off. Wait for 10 seconds until you power it on again.*

Selecting an input source

Turn on the connected source that you want to display on the screen, such as computer, notebook, and/or video player. The projector will automatically detect the input source. If multiple sources are connected, press the **Input** button on the remote control or **Input** key on the projector keypad to select an input source.

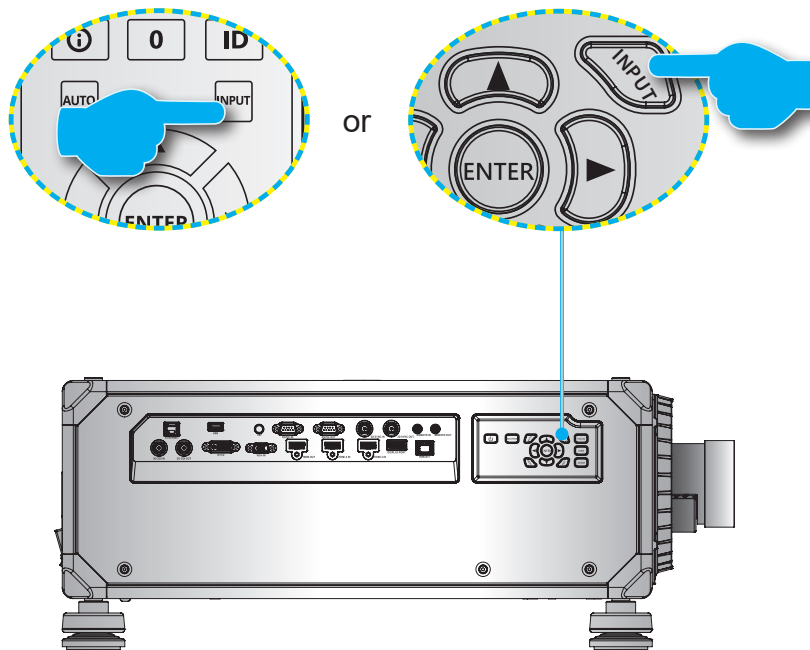

USING THE PROJECTOR

Menu navigation and features

The projector has multilingual on-screen display (OSD) menus that allow you to make image adjustments and change a variety of settings.

1. To open the OSD menu, press the **Menu** key on the remote control or projector keypad.
2. To select a main menu or submenu, use the **▲** and **▼** buttons to highlight it. Then, press the **Enter** key to enter the submenu.
3. Press the **Exit** key to return to the previous menu or exit the OSD menu if at top level.
4. Setting methods to adjust the function value or selection an option.
 - To adjust the slide bar values, highlight the function, and use the **◀▶** buttons to change value.
 - To check or uncheck a checkbox, highlight the function, and press **Enter**.
 - To input a number or symbol, highlight the number or symbol, and use the **▲** and **▼** buttons to make a selection. You can also use the number keys on the remote control or keypad.
 - To select a function option, use the **▲▼◀▶** buttons to make the selection. If no **Enter** icon shows at the navigation bar, the highlighted option is automatically applied. If there is an **Enter** icon at the navigation bar, press **Enter** to confirm your selection.

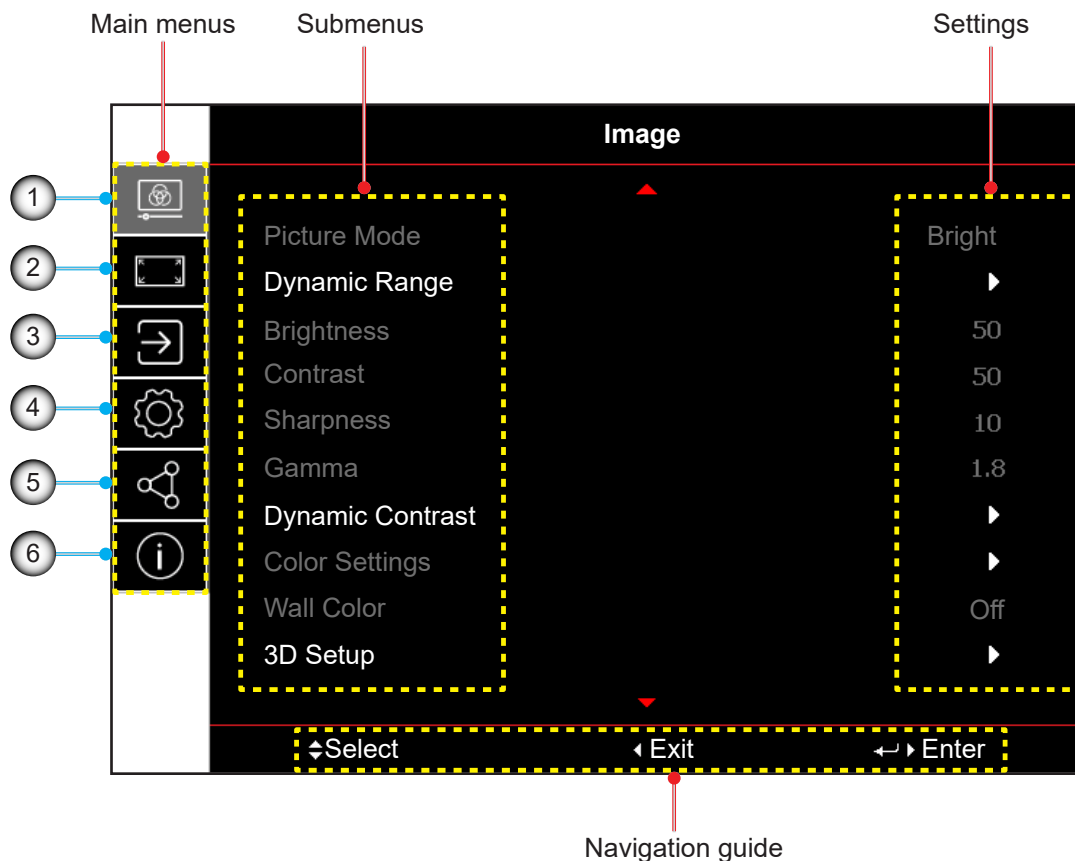

No	Item	No	Item
1.	Image menu	4.	Device setup menu
2.	Display menu	5.	Communication menu
3.	Input settings menu	6.	Information menu

USING THE PROJECTOR

OSD menu tree

Main Menu	Sub Menu 2	Sub Menu 3	Sub Menu 4	Sub Menu 5	Sub Menu 6	Values	
Image	Picture Mode					Presentation	
						Bright	
						Super Bright (depends on model)	
						Cinema	
						HDR	
						sRGB	
						DICOM SIM.	
						Blending	
						3D	
						2D High Speed	
						User	
			Dynamic Range	HDR			Off
							Auto
				HDR Picture Mode			Bright
							Standard
					Film		
					Detail		
	Brightness				0~100		
	Contrast				0~100		
	Sharpness				1-15		
	Gamma				Film		
					Graphics		
					Standard(2.2)		
					Vivid		
					3D		
					Blackboard		
					DICOM SIM.		
					1.8		
					2.0		
					2.4		
					2.6		
	Dynamic Contrast	Dynamic Black			Off		
					On		
		Speed			1~15		
		Strength			0~3		
		Level			50%~100%		
		Extreme Black			Off		
					On		
		AV Mute Timer			0s~10s		
		Black Signal Level			0~5		

USING THE PROJECTOR

Main Menu	Sub Menu 2	Sub Menu 3	Sub Menu 4	Sub Menu 5	Sub Menu 6	Values	
Image	Color Settings	Color				0~100	
		Tint				0~100	
		Color Temperature				Warm	
							Standard
							Cool
		White Balance	Red Gain				0-100
			Green Gain				0-100
			Blue Gain				0-100
			Red Offset				0-100
			Green Offset				0-100
			Blue Offset				0-100
		White Enhancement					0-10
		Color Space					Auto
							RGB (0-255)
							RGB (16-235)
							REC709
							REC601
		Color Matching	Auto Test Pattern				Off
							On
			Red	Hue			0~254
				Saturation			0~254
				Luminance			0~254
			Green	Hue			0~254
				Saturation			0~254
				Luminance			0~254
			Blue	Hue			0~254
				Saturation			0~254
				Luminance			0~254
			Cyan	Hue			0~254
				Saturation			0~254
				Luminance			0~254
			Magenta	Hue			0~254
				Saturation			0~254
		Luminance			0~254		
	Yellow	Hue			0~254		
		Saturation			0~254		
		Luminance			0~254		
	White	Red			0~254		
		Green			0~254		
		Blue			0~254		
	Reset				Yes / Cancel (Dialog box)		

USING THE PROJECTOR

Main Menu	Sub Menu 2	Sub Menu 3	Sub Menu 4	Sub Menu 5	Sub Menu 6	Values		
Image	Wall Color					Off		
						Blackboard		
						Light Yellow		
						Light Green		
						Light Blue		
						Pink		
						Gray		
	3D Setup	3D Mode					Off	
							Active 3D	
							Passive 3D	
		3D Format						Auto
								Frame Packing
								Side by Side
								Top and Bottom
								Frame Sequential
		3D Tech						DLP-link
								3D Sync
		3D-2D						3D
								L
								R
		3D Sync Out						To Emitter
								To Next Projector
		3D Invert						Off
								On
			Frame Delay					1~200
			Reset					Yes / Cancel (Dialog box)
		Save to User					Yes / Cancel (Dialog box)	
Apply to User						User-Presentation		
						User-Bright		
						User-Super Bright		
						User-Cinema		
						User-HDR		
						User-sRGB		
						User-DICOM SIM.		
						User-Blending		
						User-3D		
						User-2D High Speed		
	Reset					Yes / Cancel (Dialog box)		

USING THE PROJECTOR

Main Menu	Sub Menu 2	Sub Menu 3	Sub Menu 4	Sub Menu 5	Sub Menu 6	Values			
Display	Aspect Ratio					Auto			
						4:3			
							16:9		
							16:10		
							LBX		
							Native		
	Digital Zoom	Proportional					Off		
							On		
		Horizontal				50%~400%			
		Vertical				50%~400%			
		Horizontal Shift				0~100			
		Vertical Shift				0~100			
		Reset					Yes / Cancel (Dialog box)		
	Image Shift	H. Position					0~100		
		V. Position					0~100		
		Reset					Yes / Cancel (Dialog box)		
	Geometric Correction	Warp Control					Basic		
							Advanced		
								AP	
		Basic Warp	Keystone		Horizontal			0~40	
					Vertical			0~40	
			Pincushion		Horizontal			0~100	
					Vertical			0~100	
			4-Corner		Top Left				
					Top Right				
		Bottom Left							
		Bottom Right							
Advanced Warp		Grid Color					Green		
							Magenta		
							Red		
							Cyan		
		Grid Background						Black	
								Transparent	
		Warp Setting	Grid Points					2x2	
								3x3	
								5x5	
							9x9		
							17x17		
	Warp Inner						Off		
							On		
	Warp Sharpness					0~9			
Blend Setting	Blend Width								
	Overlap Grid Number					4 / 6 / 8 / 10 / 12			
	Gamma					1.8 / 1.9 / 2 / 2.1 / 2.2 / 2.3 / 2.4			

USING THE PROJECTOR

Main Menu	Sub Menu 2	Sub Menu 3	Sub Menu 4	Sub Menu 5	Sub Menu 6	Values				
Display	Geometric Correction	Advanced Warp	Black Level	Area		Bottom				
						Top				
					Enable	Off				
						On				
					Edit Area					
					Add Point					
					Remove Point					
					Brightness	Brightness				
						Red	0~255			
						Green	0~255			
						Blue	0~255			
					Exit					
					Red	0~255				
					Green	0~255				
					Blue	0~255				
					Reset	Bottom	Yes / Cancel (Dialog box)			
						Top	Yes / Cancel (Dialog box)			
						All	Yes / Cancel (Dialog box)			
					Memory	Save Memory	Memory 1~Memory 5			
						Apply Memory	Memory 1~Memory 5			
						Clear Memory	Yes / Cancel (Dialog box)			
					Reset		Yes / Cancel (Dialog box)			
				Edge Mask						0~10
				Freeze Screen						Unfreeze
										Freeze
				Test Pattern						Off
										Green Grid
						Magenta Grid				
						White Grid				
						White				
						Black				
						Red				
						Green				
						Blue				
						Yellow				
						Magenta				
						Cyan				
						ANSI Contrast 4x4				
						Color bar				
					Full screen					

USING THE PROJECTOR

Main Menu	Sub Menu 2	Sub Menu 3	Sub Menu 4	Sub Menu 5	Sub Menu 6	Values	
Display	PIP/PBP	Screen				Off	
						PIP	
						PBP	
			Main Source				VGA
						HDMI1	
						HDMI2	
						DVI-D	
						DisplayPort	
						3G-SDI	
						HDBaseT	
			Sub Source				VGA
							HDMI1
							HDMI2
							DVI-D
							DisplayPort
							3G-SDI
							HDBaseT
			Swap				
			Size				Small
							Medium
							Large
			Location				PBP, Main Left
							PBP, Main Top
							PBP, Main Right
							PBP, Main Bottom
							PIP, Bottom Right
							PIP, Bottom Left
					PIP, Top Left		
				PIP, Top Right			
	Reset				Yes / Cancel (Dialog box)		
Input Settings	Auto Source				Off		
					On		
	Active Inputs				VGA		
					HDMI1		
					HDMI2		
					DVI-D		
					DisplayPort		
					3G-SDI		
					HDBaseT		
	Latency Adjustment				Normal		
				2D Ultra			

USING THE PROJECTOR

Main Menu	Sub Menu 2	Sub Menu 3	Sub Menu 4	Sub Menu 5	Sub Menu 6	Values	
Input Settings	Backup Input	Auto Switch				Off	
						On	
		Current Signal				(read only)	
		First Input				HDMI1	
						HDMI2	
						HDBaseT	
						DisplayPort	
		Second Input				HDMI1	
						HDMI2	
						HDBaseT	
						DisplayPort	
		Backup Input Status				Active/Inactive (read only)	
		Backup Input Change				Changed/No Change (read only)	
		Backup Input Info.	Current Signal				(read only)
				Backup Input Status			Active/Inactive (read only)
				Backup Input Change			Changed/No Change (read only)
				First Input			By First Input (read only)
				Resolution			(read only)
				Horz Refresh			(read only)
				Color Space			(read only)
				HDR			Yes/No (read only)
				Second Input			By Second Input (read only)
				Resolution			(read only)
				Horz Refresh			(read only)
				Color Space			(read only)
				HDR			Yes/No (read only)
				VGA	Phase		
Resolution			(read only)				
HDMI	Output				HDMI 1		
					HDMI 2		
	HDMI 1 EDID				1.4		
					2.0		
					2.0		
HDMI 2 EDID				1.4			
				2.0			
HDBaseT	EDID				1.4		
					2.0		
Reset					Yes / Cancel (Dialog box)		

USING THE PROJECTOR

Main Menu	Sub Menu 2	Sub Menu 3	Sub Menu 4	Sub Menu 5	Sub Menu 6	Values	
Device Setup	Language					English	
						Deutsch	
						Français	
						Italiano	
						Español	
						Português	
						Polski	
						Nederlands	
						Norsk	
						繁體中文	
						簡體中文	
						日本語	
						한국어	
						Русский	
				Magyar			
				ไทย			
Projection	Ceiling					Auto	
						On	
							Off
	Rear					Off	
						On	
Lens Settings	Focus					+	
						-	
	Zoom						⊕
							⊖
	Lens Shift						▲
							▼
							◀
							▶
	Lens Memory	Save Memory					Memory 1~Memory 5
							Apply Memory
							Clear Memory
						Yes / Cancel (Dialog box)	
						Yes / Cancel (Dialog box)	
						Lock	
						Unlock	
						Reset	
						Yes / Cancel (Dialog box)	
Active Image Setup	Active Focus					Yes / Cancel (Dialog box)	
		Active Color Uniformity	Calibration			Yes / Cancel (Dialog box)	
			Target Selection			Pop-up pattern	
			Reset			Yes / Cancel (Dialog box)	
Schedule	Date and Time					----/--/-- --:--	
	Schedule Mode					Off / On	
	View Today					Monday / Tuesday / Wednesday / Thursday / Friday / Saturday / Sunday	

USING THE PROJECTOR

Main Menu	Sub Menu 2	Sub Menu 3	Sub Menu 4	Sub Menu 5	Sub Menu 6	Values	
Device Setup	Schedule	Monday / Tuesday / Wednesday / Thursday / Friday / Saturday / Sunday	Schedule Enable			Off	
						On	
			Event 01-16	Time			00:00 ~ 23:59
				Function			Off / Power Settings / Input Source / Light Source Mode / Shutter
				Event			Off
				(Function = Power Settings)			Power On / Eco / Active / Communication
				(Function = Input Source)			VGA / HDMI1 / HDMI2 / DVI-D / DisplayPort / 3G-SDI / HDBaseT
				(Function = Light Source Mode)			Normal Mode / Eco Mode / Custom Brightness
				(Function = Shutter)			Shutter On / Shutter Off
			Reset			Yes / Cancel (Dialog box)	
			Copy Events To			Monday / Tuesday / Wednesday / Thursday / Friday / Saturday / Sunday	
	Reset the Day			Yes / Cancel (Dialog box)			
	Reset Schedule			Yes / Cancel (Dialog box)			
	Date and Time	Clock Mode			Use NTP Server		
					Manual		
		Date			2000 ~ 2037 (Year)		
					01 ~ 12 (Month)		
					01 ~ 31 (Day)		
		Time			00 ~ 23 (Hour)		
					00 ~ 59 (Minute)		
		Daylight Saving Time			Off		
					On		
		NTP Server			time.google.com		
				asia.pool.ntp.org			
				europa.pool.ntp.org			
			north-america.pool.ntp.org				
Time Zone			UTC+14:00				
			UTC+13:00				
			UTC+12:45				
			UTC+12:00				
			UTC+11:00				
			UTC+10:30				
			UTC+10:00				
			UTC+09:30				
			UTC+09:00				
			UTC+08:45				
		UTC+08:00					
		UTC+07:00					

USING THE PROJECTOR

Main Menu	Sub Menu 2	Sub Menu 3	Sub Menu 4	Sub Menu 5	Sub Menu 6	Values
Device Setup	Date and Time	Time Zone				UTC+06:30
						UTC+06:00
						UTC+05:45
						UTC+05:30
						UTC+05:00
						UTC+04:30
						UTC+04:00
						UTC+03:30
						UTC+03:00
						UTC+02:00
						UTC+01:00
						UTC+00:00
						UTC-01:00
						UTC-02:00
						UTC-03:00
						UTC-03:30
						UTC-04:00
						UTC-05:00
						UTC-06:00
						UTC-07:00
			UTC-08:00			
			UTC-09:00			
			UTC-09:30			
			UTC-10:00			
			UTC-11:00			
			UTC-12:00			
		Update Interval				Hourly
						Daily
		Apply				Yes / Cancel (Dialog box)
Power Settings	Power Mode (Standby)					Eco
						Active
						Communication
		Signal Power On				Off
						On
		Auto Power Off				0~180 m
		Sleep Timer				0~16 h
		12V Trigger				Off
				On		
		Reset				Yes / Cancel (Dialog box)
Light Source Settings	Light Source Mode					Normal
						Eco Mode
						Custom Power
		Custom Brightness	Brightness Level			30%~100%
			Constant Brightness			Off
				On		

USING THE PROJECTOR

Main Menu	Sub Menu 2	Sub Menu 3	Sub Menu 4	Sub Menu 5	Sub Menu 6	Values
Device Setup	Shutter	Fade-In				0.5~5s
		Fade-Out				0.5~5s
		Startup				Shutter Off
						Shutter On
Security	Security					Off
						On
	Security Timer	Month				0-35
		Day				0-29
		Hour				0-23
		Change Password				
On Screen Display	Menu Location					Top Left
						Top Right
						Center
						Bottom Left
						Bottom Right
		Menu Transparency				0~9
	Menu Timer					Off
						5s
						10s
						15s
						30s
	Information Hide					60s
						Off
	Background					On
					Blue	
					Black	
					White	
Logo Setup	Change Logo					Logo
						Default Logo
						Neutral
						User Logo
	Logo Capture					Captured Logo
						Yes / Cancel (Dialog box)
Delete Logo	Captured Logo				Yes / Cancel (Dialog box)	
	User Logo				Yes / Cancel (Dialog box)	
Backlight	Keypad					Off
						On
	Power key					Off
						On
High Altitude					Off	
					On	
User Data	Save all settings					Memory 1~Memory 5
	Load all settings					Memory 1~Memory 5
System Update (FOTA)	Auto					On
						Off
	Update					Yes / Cancel (Dialog box)

USING THE PROJECTOR

Main Menu	Sub Menu 2	Sub Menu 3	Sub Menu 4	Sub Menu 5	Sub Menu 6	Values		
Device Setup	Reset	Reset OSD				Yes / Cancel (Dialog box)		
		Reset to default				Yes / Cancel (Dialog box)		
	Reset Selective	Image				Yes / Cancel (Dialog box)		
		Display				Yes / Cancel (Dialog box)		
		Input				Yes / Cancel (Dialog box)		
		Communication				Yes / Cancel (Dialog box)		
Setup				Yes / Cancel (Dialog box)				
Communication	Projector ID					0~99		
	Remote Setup	Remote Code					0~99	
		Quick Switch Code					Off	
							1~9	
		IR Function	Front					Off
								On
			Top					Off
								On
		HDBaseT					Off	
							On	
		User 1					Freeze Screen	
							Blank Screen	
						PIP/PBP		
						Aspect Ratio		
						Information Hide		
						Network setup		
						Projector ID		
						Color Matching		
						Reset Selective		
	User 2					Freeze Screen		
						Blank Screen		
						PIP/PBP		
						Aspect Ratio		
						Information Hide		
						Network setup		
						Projector ID		
						Color Matching		
					Reset Selective			
Network Setup		LAN Interface				RJ-45		
						HDBaseT		
		MAC Address				(read only)		
		Network Status				(read only) Connected / Disconnected		
		DHCP				Off		
						On		
		IP Address					
		Subnet Mask					
		Gateway					
		DNS					
		Apply				Yes / Cancel (Dialog box)		
		Network Reset				Yes / Cancel (Dialog box)		

USING THE PROJECTOR

Main Menu	Sub Menu 2	Sub Menu 3	Sub Menu 4	Sub Menu 5	Sub Menu 6	Values	
Communication	Email Notification	Email 1				Email 1 Address (read only)	
		Email 2				Email 1 Address (read only)	
		Event					
		Fan Error				Off/Email	
		Power On/Off				Off/Email	
		Video Loss				Off/Email	
		Laser				Off/Email	
		Reset				Yes / Cancel (Dialog box)	
	Control	Crestron					Off
							On
		IP Address					---.---.---.---
		IPID					2~255
		Port					0~65535
		Crestron Setup Apply					Yes / Cancel (Dialog box)
		PJ Link					Off
							On
		Authentication					Off
							On
		Password					(read only)
Service					---.---.---.---		
PJ Link Setup Apply					Yes / Cancel (Dialog box)		
	Extron					Off	
						On	
	AMX					Off	
						On	
	Telnet					Off	
						On	
	HTTP					Off	
						On	
	Reset					Yes / Cancel (Dialog box)	
	Baud Rate	Serial Port In					1200
							2400
						4800	
						9600	
						19200	
						38400	
						57600	
					115200		
Serial Port Out							1200
							2400
							4800
							9600
							19200
							38400
						38400	

USING THE PROJECTOR

Main Menu	Sub Menu 2	Sub Menu 3	Sub Menu 4	Sub Menu 5	Sub Menu 6	Values	
Communication	Baud Rate	Serial Port Out				57600	
						115200	
	Reset					Yes / Cancel (Dialog box)	
Information	Device	Regulatory					
		Serial Number					
		Projection Hours					
	System Status	Standby Mode					
		Light Source Mode					
		Light Source Hours					
		Total Hours					
		Normal					
		Eco Mode					
		Custom Power					
		Temperature					
		AC Voltage					
		Communication	Projector ID				
	Remote Code						
	LAN Interface						
	MAC Address						
	Network Status						
	DHCP						
	IP Address						
	Subnet Mask						
	Gateway						
	DNS						
	Crestron						
	Extron						
	PJ Link						
	AMX						
	Telnet						
	HTTP						
	Signal	Input Signal					
		Resolution					
		Signal Format					
		Pixel Clock					
		Horz Refresh					
		Vert Refresh					
		Color Space					
		Picture Mode					
		Second Signal					
		Resolution					
		Signal Format					
Pixel Clock							
Horz Refresh							
Vert Refresh							
Color Space							

USING THE PROJECTOR

Main Menu	Sub Menu 2	Sub Menu 3	Sub Menu 4	Sub Menu 5	Sub Menu 6	Values
Information	Backup Input	Current Signal				
		Backup Input Status				
		Backup Input Change				
		First Input				
		Resolution				
		Horz Refresh				
		Color Space				
		HDR				
		Second Input				
		Resolution				
		Horz Refresh				
		Color Space				
		HDR				
		Firmware Version	Main Version			
	I-SCALER Version					
	F-MCU Version					
	M-MCU Version					
	L-MCU Version					
	A-MCU Version					
	K-MCU Version					
	LAN Version					
	Formatter Version					
	FPGA0 Version					
	FPGA1 Version					
	FPGA2 Version					
	XFPGA Version					
HDBaseT Version						
Camera Version						

USING THE PROJECTOR

Image menu

Learn how to configure image settings.

Submenus

- Picture Mode
- Dynamic Range
- Brightness
- Contrast
- Sharpness
- Gamma
- Dynamic Contrast
- Color Settings
- Wall Color
- 3D Setup

Picture Mode

Picture Mode menu provides various functions to optimize the projected image to achieve the best image quality in all kinds of surroundings, in consideration of factors such as input source, screen color, and ambient lighting.

Presentation

Best for displaying presentation slides in a bright room.

Bright/Super Bright

Best for the installations requiring high brightness images.

Note: *Super Bright is supported only by specific model. When AC input is 100-120V, the super bright mode option will be gray out.*

Cinema

Best for videos projected in a dark room.

HDR

Best for displaying High Dynamic Range (HDR) content.

sRGB

Standardized image color that matches the sRGB color standard.

DICOM SIM.

Best for projecting monochrome medical images, such as X-ray diagram.

Blending

Best for multiple projector installations.

3D

Best for playing 3D videos.

2D High Speed

Display the status of 2D High Speed mode (This mode should not be used for medical diagnosis).

Note: *If the resolution of the input source is 800 x 600 @120Hz, 1024 x 768 @120Hz, or 1280 x 720 @120Hz, then the display mode will automatically switch to 2D High Speed then the 3D mode, PIP/PBP modes are not supported.*

USING THE PROJECTOR

User

Image settings saved by the user.

Dynamic Range

Configure the HDR setting and its effect when displaying video from 4K Blu-ray players and streaming devices.

HDR

Enable or disable HDR processing.

HDR Picture Mode

- **Bright:** Select this mode for more saturated colors.
- **Standard:** Select this mode for natural looking images.
- **Film:** Select this mode for improved detail.
- **Detail:** Select this mode for more detail in dark scenes.

Brightness

Adjust the luminous brightness of the projected image to adapt to different ambient light.

Contrast

Adjust the contrast ratio of the projected image. The contrast controls the degree of difference between the lightest and darkest parts of the image.

Sharpness

Adjust the clarity of details in the projected image to make the image clearer and sharper.

Gamma

Select an appropriate gamma value to optimize the image conformance to different input sources.

Film

Best for home theater setting.

Graphics

Best for projecting photos from PC input.

Standard (2.2)

Standard gamma value.

Vivid

Best for playing games. In this mode, color saturation and brightness are well-balanced.

3D

Best for playing 3D videos.

Blackboard

Best for projecting on to a blackboard.

DICOM SIM.

Best for projecting monochrome medical images, such as X-ray diagram.

1.8 / 2.0 / 2.4 / 2.6

Select a preset gamma value to adjust the image performance. In general, the smaller the value, the brighter the dark areas of the image will become.

USING THE PROJECTOR

Dynamic Contrast

Set up Dynamic Contrast to maximize the contrast for dark content.

Dynamic Black

Enable this function to automatically adjust the contrast ratio for video sources. It improves the black level in dark scenes by reducing the light output.

- **Speed:** Adjust the speed of the light source correction. The value ranges from 1 to 15. A lower value makes the correction slower and less aggressive while a higher value results in the faster correction.
- **Strength:** Set the strength of the dynamic contrast adjustment. The value ranges from 0 to 3, the higher the value the stronger the correction.
- **Level:** Adjust the light source when the brightness level of the current content gets lower than the set value. The value ranges from 50% to 100%. The higher the value, the larger the range to adjust the light source.

Extreme Black

Enable this function to automatically increase the contrast ratio by turning off the laser light when black image is detected.

- **AV Mute Timer:** Set a timer for the laser light to turn off after detecting black content. The set value ranges from 0s to 10s.
- **Black Signal Level:** Set a black level value as the threshold for the Real Black function. The value can be adjusted from 0% to 5%, with 0 being the darkest black and 5 being the brightest.

Color Settings

Configure the color settings of the projected image to improve the color performance.

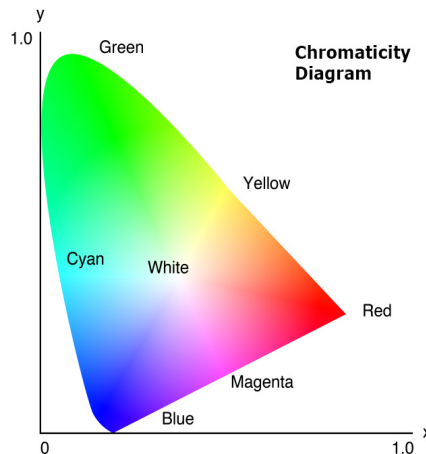

Color

Adjust the saturation of the selected color. The value indicates the color shifts from or towards the white in the center of the chromaticity diagram.

Tint

Adjust the color balance of red and green in video images.

Color Temperature

Adjust the color temperature of the projected image. The available options are Warm, Standard, and Cool.

USING THE PROJECTOR

White Balance

Adjust the white balance of the projected image via gain and offset. Gain and offset are individual controls for each RGB channels used to set greyscale. The Gains calibrate the color of the dark parts and Bias calibrate the white parts.

- **Red / Green / Blue Gain:** Adjust the color of the image's bright areas.
- **Red / Green / Blue Offset:** Adjust the color of the image's dark areas.

White Enhancement

Adjust the image color brightness while providing more vibrant colors, in increments from 0 to 10.

Color Space

Select a color space that has been specifically tuned for the input signal. The available options are Auto, RGB (0~255), RGB (16~235), REC709, and REC601.

Note: *The Color Space function is grayed out if the Picture Mode is sRGB or without any source input.*

Color Matching

Change the color of a projected image by adjusting each color component in the image. The adjustable color includes Red, Green, Blue, Cyan, Yellow, and Magenta (R / G / B / C / Y / M).

- **Auto Test Pattern:** Enable the function to view a specific color pattern while adjusting.
- **Red / Green / Blue / Cyan / Magenta / Yellow:** Select a color for further adjustment.
 - **Hue:** Adjust the hue of the selected color. The value reflects the number of degrees of rotation around the chromaticity diagram from the original color. Increasing value indicates counterclockwise rotation, and decreasing value, clockwise rotation.
 - **Saturation:** Adjust the saturation of the selected color. The value reflects the color shifts from or towards the white in the center of the chromaticity diagram.
 - **Luminance:** Adjust the luminance of the selected color. Increase the value to brighten the image (add white to a color) or decrease the value to darken the image (add black to a color).
- **White:** Adjust the white color performance via setting the Red, Green, and Blue values.
 - **Red / Green / Blue:** Adjust the red, green, and blue colors to optimize the white color performance.
- **Reset:** Reset the function settings to factory default values.

Wall Color

Set the wall color of the projector to achieve best color performance for a specific wall. The available options are Off, Blackboard, Light Yellow, Light Green, Light Blue, Pink, and Gray.

3D Setup

3D video file combines two slightly different images (frames) of the same scene representing the different views that the left and right eyes see. When these frames are displayed fast enough and viewed with 3D glasses synchronized with the left and right frames, the viewer's brain then assemble the separate images into a single 3D image. 3D Menu provides options to set up the 3D functions to correctly display 3D videos.

3D Mode

Enable or disable the 3D function.

3D Format

Select a proper 3D format for the 3D input signal. The available options are Auto, Frame Packing, Side by Side, Top and Bottom, and Frame Sequential.

USING THE PROJECTOR

3D Tech

Select a proper 3D technology according to how the 3D sync signal is processed.

- **DLP-Link:** Select DLP-Link when the 3D sync signal is generated by the DLP Link technology built into the projector. DLP Link works only with the glasses that are compatible with DLP 3D technology and the 3D function is enabled
- **3D Sync:** Select 3D Sync when the 3D sync out signal is sent to an emitter or another projector through the 3D sync out port.

3D-2D

Transform the 3D content to 2D images.

- **3D:** Play the 3D content normally.
- **L:** Play the left images of the 3D content.
- **R:** Play the right images of the 3D content.

3D Sync Out

Set up the transmission of the 3D sync output signal.

- **To Emitter:** Send the 3D sync signal to the emitter connected to the 3D sync out port.
- **To Next Projector:** Send the 3D sync signal to next projector when using multiple projectors.

IR Control setup when using the 3D IR emitter

Infrared devices interfere with each other if placed in the same sensing angle. If you want to use the 3D IR emitter and the IR remote function, do any of the following:

- Place the 3D IR emitter outside the IR remote control sensing angle as shown below:

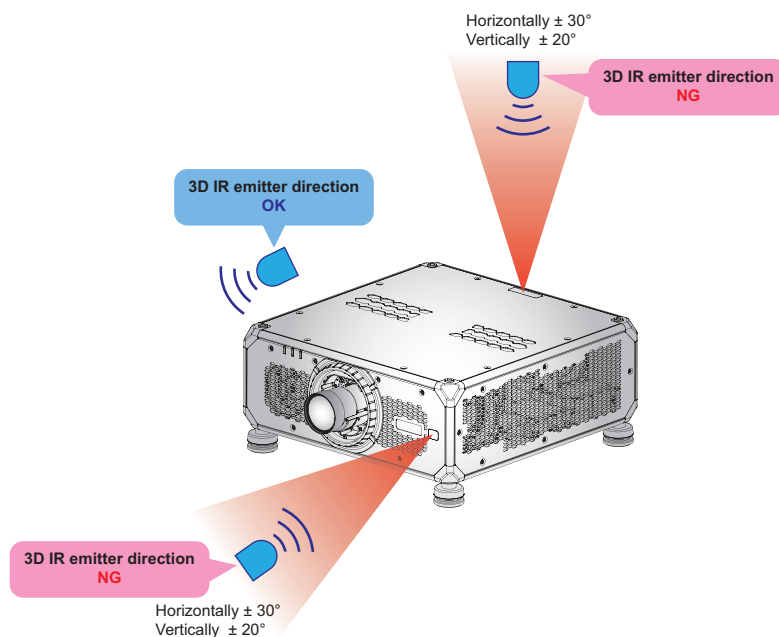

- Based on the room layout, disable either the front or the top remote receiver in the OSD menu > Communication > Remote Setup > IR Function menu to avoid the 3D IR emitter interference, yet allowing to use the IR remote control function.

USING THE PROJECTOR

If neither of the two methods described above solved the problem, please use another 3D IR emitter/3D RF emitter or try any of the following two methods.

- Use a wired remote-in cable for the IR control.

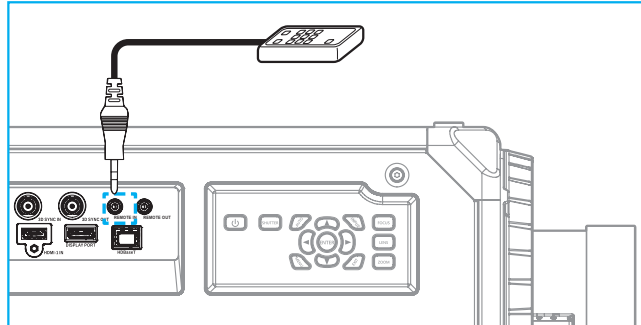

- Use the IR control via the HDBaseT device (not supplied).

Note: *Disable the Front/Top remote receivers and enable the HDBaseT for IR control in the OSD menu > Communication > Remote Setup > IR Function.*

3D Invert

When the 3D video does not appear correctly, use this function to invert the 3D left and right frames.

Frame Delay

Set a frame delay value for the projector to correct the time difference between the 3D signal being given and the result being executed. This function works only when L/R Reference is set to Field GPIO. When performing 3D blending on multiple projectors, set the frame delay for each projector to correct the non-synchronous images.

Reset

Reset the function settings to factory default values.

Save to User

Save the image settings to the User mode.

Apply to User

Apply the image settings to User-Presentation, User-Bright, User-Super Bright, User-Cinema, User-HDR, User sRGB, User-DICOM SIM., User-Blending, User-3D, or User-2D High Speed.

Reset

Reset all 3D settings.

USING THE PROJECTOR

Display menu

Learn how to configure the settings to properly project images according to your installation circumstances.

Submenus

- Aspect Ratio
- Digital Zoom
- Image Shift
- Geometric Correction
- Edge Mask
- Freeze Screen
- Test Pattern
- PIP/PBP

Aspect Ratio

Set the aspect ratio of the projected image. The available options are Auto, 4:3, 16:9, 16:10, LBX, or Native. Select Auto to display the detected image size.

Digital Zoom

Digitally adjust the size of the projected image.

Note: *Image projection on the screen depends on the signal source..*

Proportional

Enable the function to have the image's height and width changed at the same ratio.

Horizontal

Use the ◀ and ▶ buttons to change the width of the projected image.

Vertical

Use the ▲ and ▼ buttons to change the height of the projected image.

Horizontal Shift

Use the ◀ and ▶ buttons to horizontally shift the image.

Vertical Shift

Use the ▲ and ▼ buttons to vertically shift the image.

Reset

Reset digital zoom settings to factory default values.

Image Shift

Adjust the projected image position.

Note: *Different signal sources have different range of image displacement.*

H. Position

Use the ◀ and ▶ buttons to adjust the projected image position horizontally.

V. Position

Use the ▲ and ▼ buttons to adjust the projected image position vertically.

Reset

Reset image shift settings to factory default values.

USING THE PROJECTOR

Geometric Correction

Configure the geometric settings to reshape the image for different projection surfaces.

Warp Control

Configure warp settings. Select between Basic, Advanced, and AP.

- **Basic:** Configure keystone, pincushion, 4-corner settings.
- **Advanced:** Set the grid color and grid background, as well as configure warp and blend settings.
- **AP:** Use the warp and blend software tools to control the projector. When the software warp and blend control is enabled, the projector's built in geometry functions are disabled.

Basic Warp

Configure basic warp settings.

- **Keystone:** Keystone function is used to adjust the images in asymmetric rectangle shape.
 - **Horizontal:** Adjust the left and right side of the projected image to make it an even rectangle. It is used for the images with unequal left and right sides.

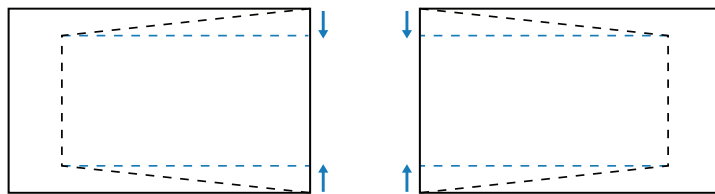

- **Vertical:** Adjust the top and bottom side of the projected image to make it an even rectangle. It is used for the images with unequal top and bottom sides.

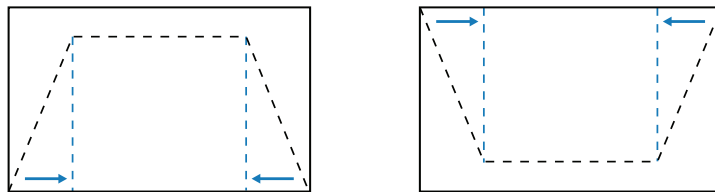

- **Pincushion:** Pincushion function is used to adjust the image with barrel or pincushion distortion.
 - **Horizontal:** Correct the projected image with horizontal barrel or pincushion distortion.

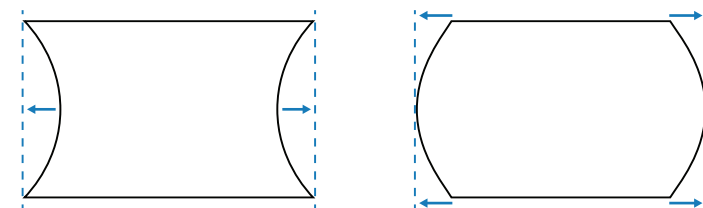

- **Vertical:** Correct the projected image with vertical barrel or pincushion distortion.

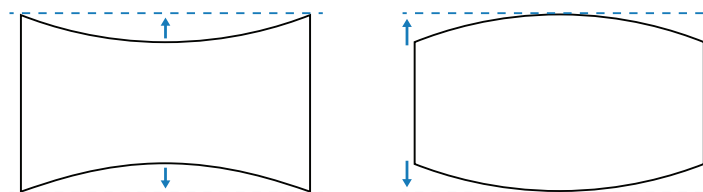

USING THE PROJECTOR

- **4-Corner:** Reshape the image by moving the 4 corners of the image to have it fit a specific projection surface.

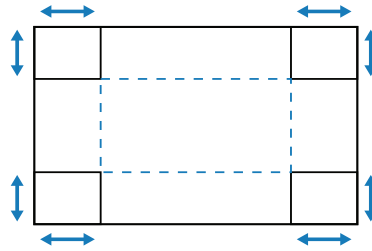

Advanced Warp

Configure advanced warp settings.

- **Grid Color:** Select a grid color for warp and blend pattern between Green, Magenta, Red, and Cyan.
- **Grid Background:** Select the grid background between Black and Transparent.
- **Warp Setting:** Configure warp settings.
 - **Grid Point:** Adjust flat and curved surfaces.
 - **Warp Inner:** Turn on to adjust the inner grid.
 - **Warp Sharpness:** When the grid lines are warped from straight into curve, the grid lines will be distorted and become jagged. To avoid the line jaggging, adjust the warp sharpness to blur or sharpen the edge of the images.
- **Blend Setting:** Configure the blend settings directly on the projector to merge two or more adjacent images into one larger and seamless image.
 - **Blend Width:** Set the blend pattern width.
 - **Overlap Grid Number:** Set the blend overlap grid number.
 - **Gamma:** Select the gamma value of the blend area to adjust the curvature of the blending effect.

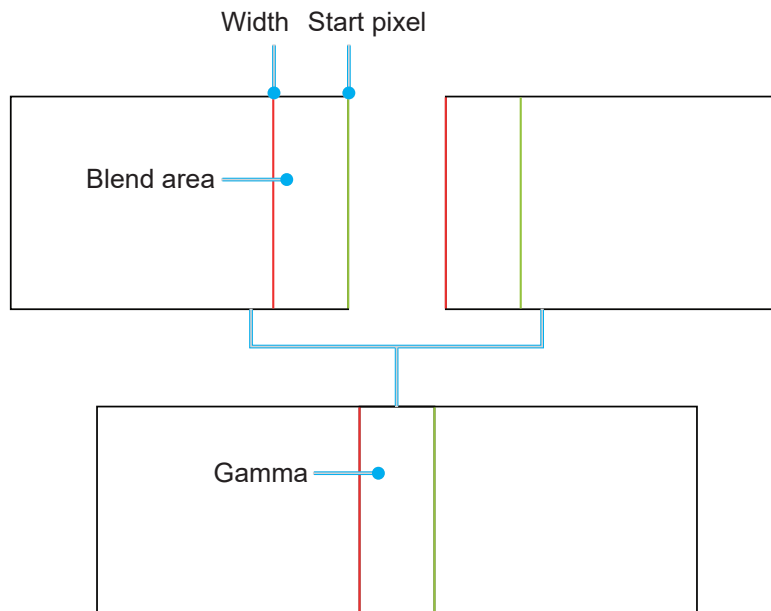

- **Black Level:** Manually adjust the black level of the projected image.
 - **Area:** Mark the area that needs adjusting.
 - **Enable:** Enable or disable the black level adjustment in the selected area.
 - **Edit Area:** Modify the black level of the selected area.
 - **Add Point:** Add up to 32 area control points for black level adjustment.
 - **Remove Point:** Remove at least 4 control points from the selected area.

USING THE PROJECTOR

Note: After adding or removing a control point, press **Enter** to move to the next point counterclockwise.

- **Brightness:** Adjust the brightness of the selected area.
- **Red/Green/Blue:** Adjust each color individually of the selected area.
- **Reset:** Reset the black level to factory default values either on the Bottom or on the Top area or on both areas.

Memory

The projector allows the user to save up to five geometry memories, including the ones set directly on the projector and the ones configured via external software tools. The available options are Save Memory, Apply Memory, and Clear Memory.

Reset

Reset geometric settings to factory default values.

Edge Mask

The edge blending function allows you to hide one or multiple edges of the projected image. You can use this function to remove the video encoding noise on the edges of the video images.

Freeze Screen

Select to pause the display screen despite any change in the source device.

Test Pattern

Select a test pattern. The available options are Off, Green Grid, Magenta Grid, White Grid, White, Black, Red, Green, Blue, Yellow, Magenta, Cyan, ANSI Contrast 4x4, Color bar, and Full screen.

PIP/PBP

PIP/PBP (picture in picture/picture by picture) allows simultaneously displaying two images from two input sources.

Screen

Select the appropriate PIP/PBP mode or disable the function.

- **Off:** Disable PIP/PBP mode.
- **PIP:** Display one input source on the main screen and the other input source in an inset window.
- **PBP:** Display two images of the same size on the screen.

Main Source

Select an input source for the main image. The available input sources are VGA, HDMI1, HDMI2, DVI-D, DisplayPort, 3G-SDI, and HDBaseT.

Sub Source

Select an input source for the second image. The available input sources are VGA, HDMI1, HDMI2, DVI-D, DisplayPort, 3G-SDI, and HDBaseT.

Swap

Swap the main source and sub source.

Size

Change the display size of the sub source in PIP mode.

USING THE PROJECTOR







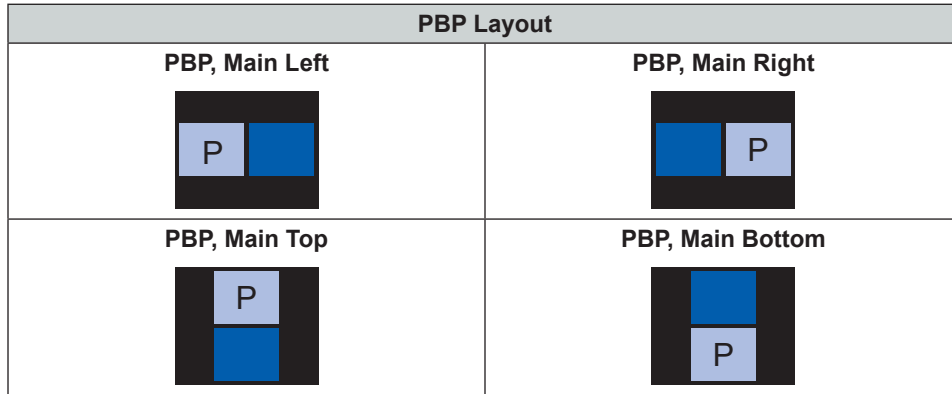





Location

Adjust the location of the sub image. In the layout chart below, the “P” indicates the main image:

- **PBP Layout**



- **PIP Layout**

PIP Layout	PIP Size		
	Small	Medium	Large
PIP, Bottom Right			
PIP, Bottom Left			
PIP, Top Left			
PIP, Top Right			

Note: Refer to the table below for PIP/PBP compatibility.

PIP/PBP Compatibility

PIP/PBP Matrix	VGA	DVI-D	HDMI-1	HDMI-2	3G-SDI	HDBaseT	DP
VGA	—	—	V	V	V	V	V
DVI-D	—	—	V	V	V	V	V
HDMI-1	V	V	—	V	V	V	V
HDMI-2	V	V	V	—	V	V	V
3G-SDI	V	V	V	V	—	V	V
HDBaseT	V	V	V	V	V	—	V
DP	V	V	V	V	V	V	—

Reset

Reset all the display settings to factory default values.

USING THE PROJECTOR

Input Settings menu

Learn how to configure the projector input settings.

Submenus

- Auto Source
- Active Inputs
- Latency Adjustment
- Backup Input
- VGA
- HDMI
- HDBaseT

Auto Source

When Auto Source is enabled, the projector automatically detects and selects the input signal. Once an input source is selected, press the Input button on the remote control or keypad to switch to other available sources. When the function is disabled, pressing Input will bring up the Active Inputs submenu.

Active Inputs

Select an input signal from the source list. The available input sources are VGA, HDMI1, HDMI2, DVI-D, DisplayPort, 3G-SDI, and HDBaseT.

Latency Adjustment

Enable this feature to reduce response time.

Note: *If the latency adjustment is set to 2D Ultra then the 3D mode, PIP modes, and 4K 30Hz resolution are not supported.*

Backup Input

Backup Input function allows the user to set up two input sources with the same timing specification. Upon loss of one input source, the projector automatically switches to the other source.

This function can be useful for the installations requiring uninterruptedly displaying the content source, such as live show, exhibition, and critical control room. The available input sources are HDMI1, HDMI2, DisplayPort, and HDBaseT.

Auto Switch

Check the box to enable automatically switching to the backup input source when the current source fails.

Current Signal

Displays the current active signal.

First Input

Select a signal as the first input source. Once the selected source is activated, the OSD menu lists out the signal's Resolution, Horz Refresh (horizontal refresh rate), and Color Space.

Second Input

Select a signal as the second input source. Once the selected source is activated, the OSD menu lists out the signal's Resolution, Horz Refresh (horizontal refresh rate), and Color Space.

USING THE PROJECTOR

Backup Input Status

Display the function status. The Backup Input Status is active when meeting the following conditions:

- Auto Switch is checked.
- The two sources are with the same timing specification.
- The two sources are active.
- Projector is displaying one of the two sources.

Backup Input Change

Display the function change.

Backup Input Info.

Display the function information, including Current Signal, Back Input Status, Backup Input Change, First Input and its Resolution, Horz Refresh, Color Space, HDR, Second Input and its Resolution, Horz Refresh, Color Space, and HDR.

VGA

Setup the VGA source by selecting the proper Phase and Resolution.

HDMI

Setup the projector's HDMI ports.

Output

Select a HDMI port to output the signal.

HDMI 1 EDID/HDMI 2 EDID

When receiving a HDMI signal, set the projector's EDID compatibility to display the signal correctly. Select **1.4** for the input devices with HDMI 1.4, or **2.0** for HDMI 2.0 devices.

HDBaseT

Configure the HDBaseT settings to correctly display the HDMI signal transferred via the HDBaseT port.

EDID

When receiving a HDMI signal via HDBaseT, set the projector's EDID compatibility to display the signal correctly. Select **1.4** for the input devices with HDMI 1.4, or **2.0** for HDMI 2.0 devices.

Reset

Reset all the input settings to factory default values.

USING THE PROJECTOR

Device Setup menu

Learn how to configure the system settings for the projector.

Submenus

- Language
- Projection
- Lens Settings
- Auto Image Setup
- Schedule
- Date and Time
- Power Settings
- Light Source Settings
- Shutter
- Security
- On Screen Display
- Logo Setup
- Backlight
- High Altitude
- User Data
- System Update

Language

Select a language for the OSD menu. The available languages are English, German, French, Italian, Spanish, Portuguese, Polish, Dutch, Norwegian, Traditional Chinese, Simplified Chinese, Japanese, Korean, Russian, Hungarian, and Thai.

Projection

Change the image direction by selecting a proper projection mode.

Ceiling

Enable the function for ceiling mount installation.

Rear

Check the function for rear projection.

Lens Settings

Configure the lens settings to adjust the image quality and position.

Focus

Use the ▲ and ▼ buttons to adjust the focus of the projected image.

Zoom

Use the ⊕ and ⊖ buttons to adjust the size of the projected image.

Lens Shift

Use the ▲ ▼ ◀ ▶ buttons to adjust the lens position to shift the projected area.

USING THE PROJECTOR

Note: A11 floating ring

- For better optical performance, manually adjust the floating ring before adjusting Zoom & Focus.
- Floating ring's label scale shows the projection distance.
- The projection distance is from the projector lens to the screen. For example, if the distance between the screen and the projector lens is 2.1m, adjust the floating ring scale to "2.10" for better performance.

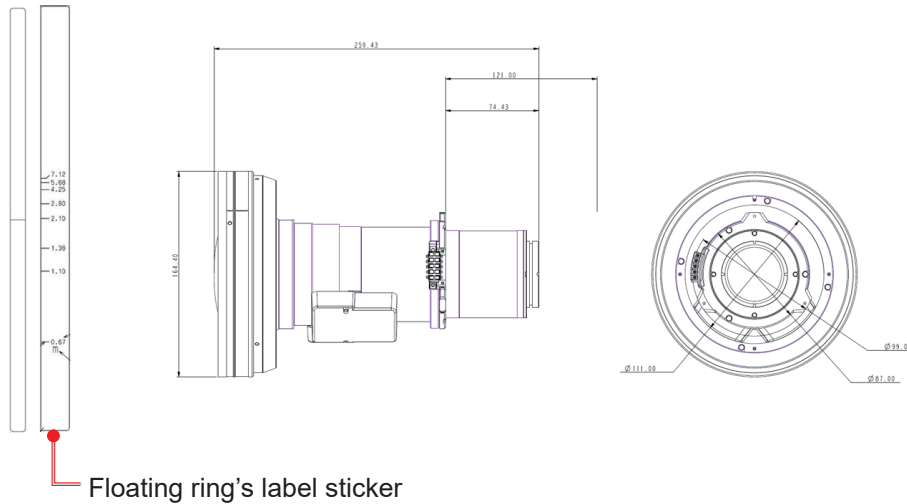

Lens Memory

This projector can save up to five lens settings, which records the lens position, zoom and focus. To record correct data, please perform lens calibration at first time processing lens memory.

- **Save Memory:** Select a record from 1 to 5 to save the current lens settings.
- **Apply Memory:** Select a record from 1 to 5 to apply the lens settings.
- **Clear Memory:** Clear the saved lens records.

Note:

- Performing a lens calibration will clear the saved lens records.
- The A18 and A19 lens do not support saving Zoom and Focus locations.
- The A22 lens restrains Zoom and Focus functions that may result in synchronization inaccuracy.

Lens Calibration

Calibrate the lens position to return it to the center. To prevent damage to the projector and the lens, always perform lens calibration before replacing the lens.

Lens Lock

Lock the lens to prevent the lens motors from moving, which disables all lens functions.

Reset

Reset the lens settings to factory default values.

Active Image Setup

Automatically adjust the image to achieve better performance.

- **Active Focus:** Automatically adjust the image focus.

Note:

- Before adjusting the Active Focus, make sure the boresight has been adjusted to the best position.
- When the remote control performs focus adjustment, pressing the **Enter** key can also trigger the Active Focus function.

USING THE PROJECTOR

- **Active Color Uniformity:** Automatically adjust the image color to fit the color of the projection screen. To maintain the optimum focus-level, the brightness of the original content may be decreased.
 - **Calibration:** Perform the calibration process. If the target content is outside the color range of the projector, the color will not be projected correctly.
 - **Target Selection:** Select the target area for calibration. The default area is the center of the content. Press **Enter** to return to the OSD menu after the selection is completed.
 - **Reset:** Clear the calibration result.

Note:

- *The Active Image Setup functions are performed via the built-in camera. Please make sure the camera is not covered or blocked by any objects. The auto adjustment process might take more than one minute to complete.*
- *The functions in the Active Image Setup menu are available for the projections from 100" to 300" and imaging range needs to cover the entire projection screen. It is recommended to use the Optoma Visual Suite software for seamless setups and calibration.*
- *For A11 lens the Active Image Setup functions can be applied only if the lens position is centred with the screen.*

Schedule

Schedule the projector functions to operate automatically at the set time.

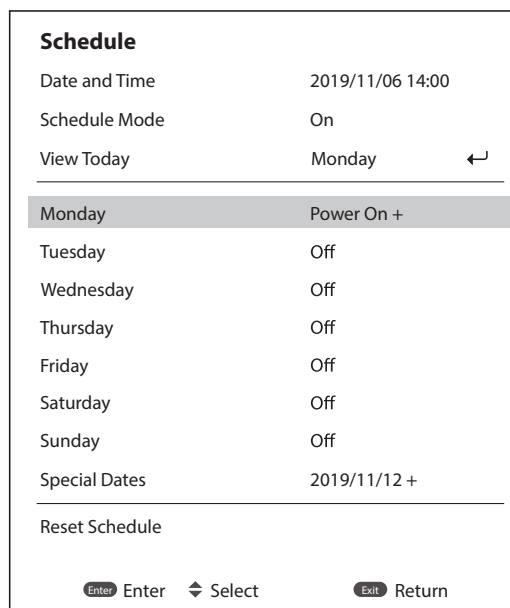

Date and Time

Before setting a schedule, setup the date and time settings. Refer to “Date and Time” on page 64.

Schedule Mode

Enable or disable the schedule function. If the projector is controlled via external devices or software, the Schedule Mode displays AP Mode, and the projector’s schedule functions are grayed out.

View Today

View the event list scheduled for today.

Note: After the schedule is set up, make sure to save all the settings.

Monday to Sunday

Set up the schedule for days of a week. On the Schedule menu page, select a day and configure the schedule settings.

USING THE PROJECTOR

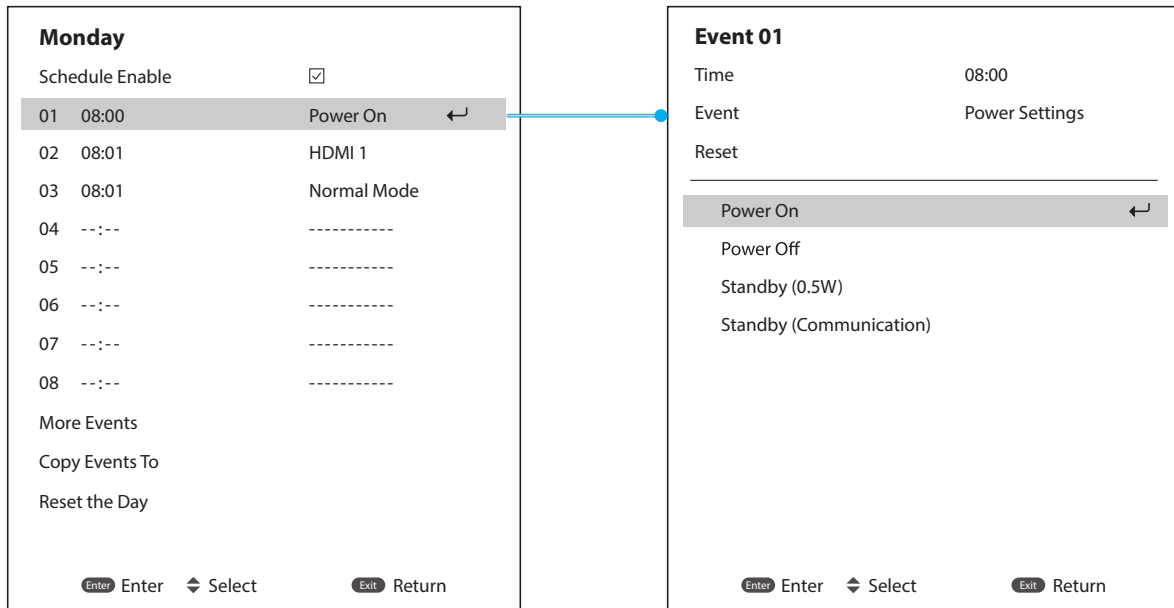

- **Schedule Enable:** Enable or disable the schedule function for the selected day.
- **Event 01-16:** Select an event record number, and set up the schedule details.
 - **Time:** Set the time for the event.
 - **Function:** Select the function. The available functions are Power Settings, Input Source, Light Source Mode, and Shutter
 - **Note:** *If the Power Setting is set to Eco or Active, then the projector cannot boot up again.*
 - **Event:** Select a function for the event, which operates automatically at the set time.
 - **Reset:** Reset the event settings.

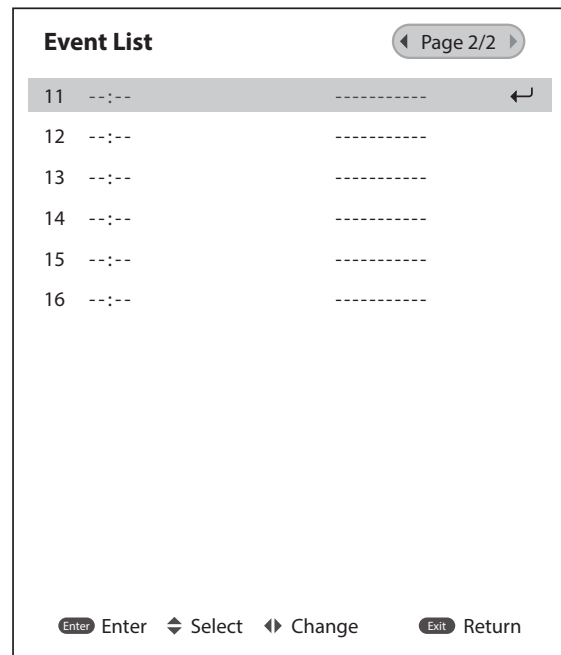
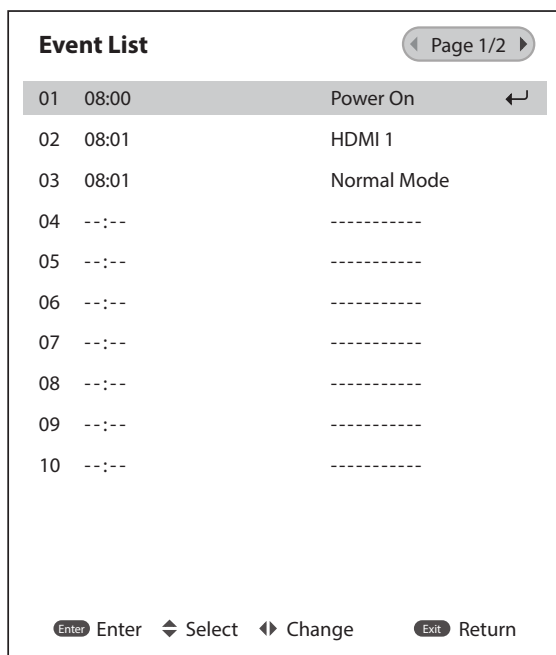

USING THE PROJECTOR

- **Copy Events To:** Copy the events setup for the day to another day.

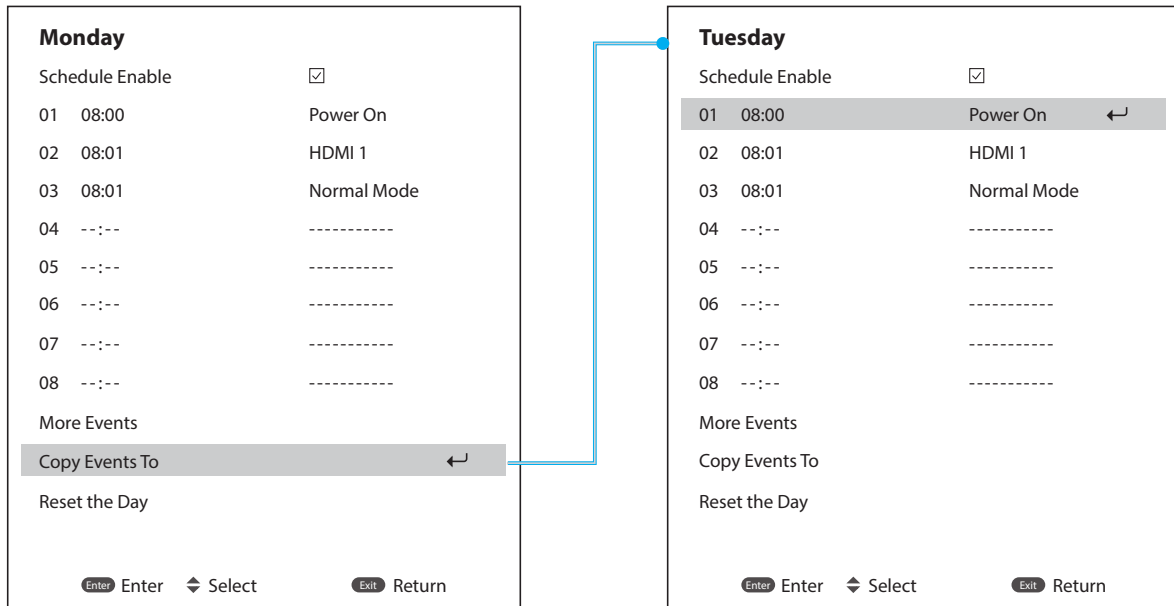

- **Reset the Day:** Reset the schedule settings for the day.

Reset Schedule

Reset all of the schedule settings.

Date and Time

Set up the projector's date and time.

Clock Mode

Set the clock mode to NTP Server or Manual.

Note: To use NTP Server, make sure the projector is connected to the Internet.

Date

Set a date for the projector. The date format is in Year/Month/Date.

Time

Set the time for the projector.

Daylight Saving Time

Enable or disable the daylight savings function.

NTP Server

Select a NTP Server for the network clock mode.

Time Zone

Set a time zone for the network clock mode.

Update Interval

Set the date and time update interval.

Apply

Apply date and time modifications.

USING THE PROJECTOR

Power Settings

Configure the projector's power settings.

Power Mode (Standby)

Setup the projector's standby mode.

- **Eco:** Minimum power consumption (< 0.5 Watt) which does not allow network control.
- **Active:** Low power consumption (< 2 Watt) which allows the LAN module to enter sleep mode and supports to be woken by Wake on LAN (WoL). When the LAN module is woken by WoL, the projector is ready to receive commands over the network.
- **Communication:** More power consumption that allows controlling the projector over the network.

Signal Power On

Turn on this function to have the projector automatically turning on when connected to HDMI input sources. It only applies to the standby projector set to Communication mode.

Auto Power Off

Set an interval timer for the projector to automatically turn off if no signal is detected within the specified time period. Press the ◀ and ▶ buttons to add or reduce time, 5 minutes for each press.

Sleep Timer

Set an interval timer for the projector to automatically turn off after operating for the specified amount of time.

12V Trigger

When enabled, the projector screen is automatically raised or lowered when the projector is turned on or off. This function only works when the projector is connected to an electrical projector screen.

Note: 3.5mm mini jack that outputs 12V 500mA (max.) for relay system control.

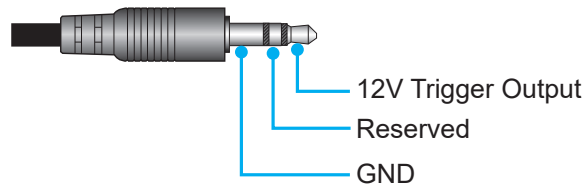

- **On:** Choose "On" to enable the trigger.
- **Off:** Choose "Off" to disable the trigger.

Reset

Reset the power settings to factory default values.

Light Source Settings

Set up the light source to control the projector brightness.

Light Source Mode

Select a light source mode depending on the installation requirements. The available options are Normal, Eco Mode, and Custom Power.

Custom Brightness

When the Light Source Mode is set to Custom Mode, set up the custom brightness level.

Set up the Constant Brightness to maintain the image brightness at a specified level. A special algorithm is designed to compensate for the natural decay of brightness so that the image can be maintained at a fixed brightness level.

- **Brightness Level:** Adjust the brightness level from 30% to 100%.
- **Constant Brightness:** Enable to maintain the image brightness at the set brightness level. A special algorithm is designed to compensate for the natural decay of brightness so that the image can be maintained at a fixed brightness level.

USING THE PROJECTOR

Shutter

Set up the shutter behavior.

Fade-In

This function allows the fading-in effect when turning off the shutter. The length of the fading effect can be adjusted from 0s to 5s.

Fade-Out

This function allows the fading-out effect when turning on the shutter. The length of the fading effect can be adjusted from 0s to 5s.

Startup

Select the shutter behavior when turning on the projector.

- **Shutter Off:** Projector projects images normally after being powered on.
- **Shutter On:** Projector automatically turns on shutter after being powered on.

Security

Set up security verification to protect the projector.

Security

Select On to protect the projector with a password. If the user enters incorrect password three times, a message will pop up warning that the projector shuts down in 10 seconds.

Security Timer

Specify the length of time the projector can be used without the password. Once the timer counts to 0, the user must enter a password to use the projector. The timer restarts every time the projector is turned on.

Change Password

Change the projector password.

Note: *In the last minute before reaching a specified timer, including Auto Power Off, Sleep Timer, and Security Timer, an on-screen message will pop up warning that the projector shuts down in 60 seconds. Press any button on the remote control or projector keypad to reset the timer and the projector remains on.*

On Screen Display

Set up the on screen display menus.

Menu Location

Select the menu location from Top Left, Top Right, Center, Bottom Left, and Bottom Right.

Menu Transparency

Set the menu transparency level.

Menu Timer

Set the length of time the menu displays on the screen.

Information Hide

Enable or disable the corner information messages, such as input source, IP address, and so on.

Background

Set a background color to display when no input signal is detected. The available options are Blue, Black, White, and Logo.

USING THE PROJECTOR

Logo Setup

Set up the logo for the startup screen.

Change Logo

Change the logo for the startup screen. Apart from the Default logo, user can select from Neutral, User Logo, and Captured Logo.

- **Default:** The projector default logo.
- **Neutral:** The logo is not displayed on the startup screen.
- **User Logo:** User customized logo.
- **Captured Logo:** The logo saved via the Logo Capture function.

Note: *The supported logo format is PNG and size is 1920 x 1200 pixels.*

Logo Capture

Capture part of the projected image and save it as a customized logo.

Delete Logo

Delete the saved customized logo, including the Captured Logo and User Logo.

Backlight

Set up the projector backlight options.

Keypad

Enable or disable the keypad backlight.

Power Key

Enable or disable the backlight for the power key.

High Altitude

Select On to increase the fan speed. To ensure the image quality and prevent damage to the projector, enable High Altitude mode in high temperature, high humidity, or high altitude environment.

User Data

User can save the projector settings as user data and reload the settings later.

- **Save all settings:** Save all of the projector settings as user data. User can save up to 5 records.
- **Load all settings:** Load the previously saved user data.

System Update (FOTA)

Update the system automatically or manually.

- **Auto:** System checks for new updates automatically every time it is connected to the Internet.
- **Auto Download:** System will download the firmware upgrade file in the background and starts the upgrade process when you power off the projector. When the upgrade is done, the projector will power off.
- **Update:** Manually update the system firmware.

Reset

Reset the settings to factory default values.

- **Reset OSD:** Reset OSD settings to default values.
- **Reset to Default:** Reset all projector settings to default values.
- **Reset Selective:** Reset the settings of one of the main menus. User can choose from Image, Display, Advanced, Input, Communication, and Setup.

USING THE PROJECTOR

Communication menu

Communication menu is used to configure the settings that allow the projector to communicate with other projectors or control devices.

Submenus

- Projector ID
- Remote Setup
- Network Setup
- Email Notification
- Control
- Baud Rate

Supplemental information

- Using the web control panel
- Using RS232 command by Telnet

Projector ID

Assign an ID code for the projector from 00 to 99. Use this code as the projector ID when controlling the projector by RS232, HDBaseT, Telnet or other control methods.

Remote Setup

Configure the settings of the Infra-Red (IR) remote control.

Remote Code

Set the remote custom code by pressing the remote ID button for 3 seconds and you will notice the remote indicator (above the Off button) starts blinking. Then, input a number between 00-99 using the keyboard numbered keys. After inserting the number, the remote indicator blinks twice quickly indicating that the remote code has changed. For more information on remote codes, refer to "Remote control ID setup" on page 26.

Quick Switch Code

The IR receiving function of the projector can be temporarily deactivated by hot key(0~9) to avoid the IR interference between projectors. The remote ID needs to be set to **All**.

Note: *When hotkey is on, the default functions are inactive temporarily.*

IR Function

Set the remote receiver for the projector to control the communication between the projector and the IR remote.

- **Front:** Enable or disable the front remote receiver.
- **Top:** Enable or disable the top remote receiver.
- **HDBaseT:** Select On to set the HDBaseT terminal as the remote receiver.

User 1 / User 2

Assign a function to the User 1 and User 2 buttons on the remote control. It allows you to use the function easily without going through the OSD menus. The available functions are Freeze Screen, Blank Screen, PIP/PBP, Aspect Ratio, Information Hide, Network Setup, Projector ID, Color Matching, and Reset Selective.

USING THE PROJECTOR

Network Setup

Configure the projector's network settings.

LAN Interface

To avoid clash, specify the LAN interface to RJ-45 or HDBaseT.

MAC Address

Display the MAC address. (Read only)

Network Status

Display the network connection status. (Read only)

DHCP

Turn on DHCP to automatically acquire IP address, subnet mask, gateway, and DNS.

IP Address

Assign the projector's IP address.

Subnet Mask

Assign the projector's subnet mask.

Gateway

Assign the projector's gateway.

DNS

Assign the projector's DNS.

Apply

Apply the wired network settings.

Network Reset

Reset the network settings to default factory values.

Email Notification

Set up email notifications for some events, which allows them to be received as early alerts via emails.

Control

This projector can be controlled remotely by a computer or other external devices through wireless or wired network connection. It allows the user to control one or more projectors from a remote control center, such as powering the projector on or off, and adjusting the image brightness or contrast.

Use the Control submenu to select a control device for the projector.

Crestron

Control the projector with Crestron controller and related software. (Port: 41794)

For more information, please visit <http://www.crestron.com>.

- **Crestron Setup:** Setup the Crestron IP Address, IPID, and Port. Then select **Crestron Setup Apply** to save the modifications.

PJ Link

Control the projector with PJLink v2.0 commands. (Port: 4352)

For more information, please visit <http://pjlink.jbmia.or.jp/english>.

- **PJ Link Service:** Setup the address for the PJ Link service and the related settings. Then select **PJ Link Setup Apply** to save the modifications.

Extron

Control the projector with Extron devices. (Port: 2023)

For more information, please visit <http://www.extron.com>.

USING THE PROJECTOR

AMX

Control the projector with AMX devices. (Port: 9131)
For more information, please visit <http://www.amx.com>.

Telnet

Control the projector using RS232 commands though Telnet connection. (Port: 23)
For more information, refer to “Using RS232 command by Telnet” on page 73.

HTTP

Control the projector with web browser. (Port: 80)
For more information, refer to “Using the web control panel” on page 71.

Optoma Management Suite (OMS)

Control the projector with OMS.
For more information, please visit <https://www.optoma.com>.

Reset

Reset the control functions to default factory values.

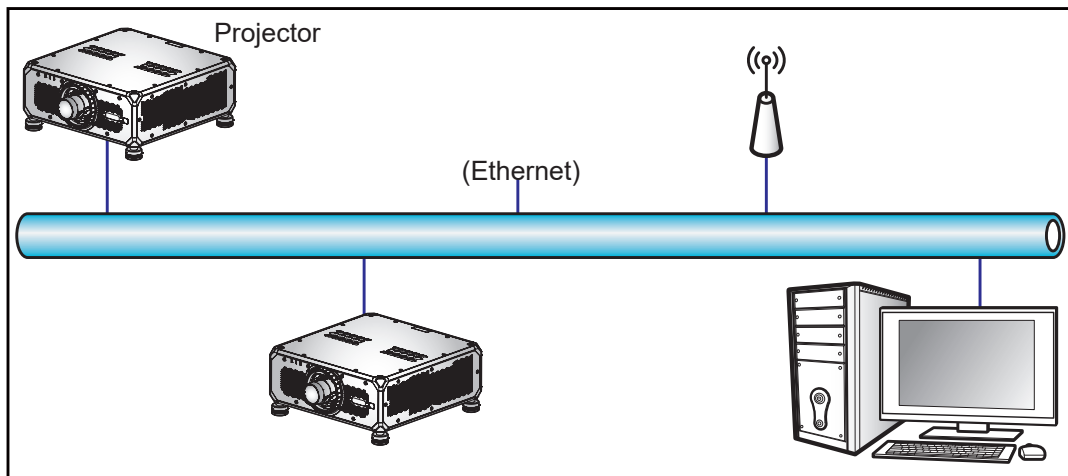

Note:

- *Crestron is a registered trademark of Crestron Electronics, Inc. of the United States.*
- *Extron is a registered trademark of Extron Electronics, Inc. of the United States.*
- *AMX is a registered trademark of AMX LLC of the United States.*
- *PJLink applied for trademark and logo registration in Japan, the United States of America, and other countries by JBMIA.*
- *For more information about the various types of external devices which can be connected to the LAN / RJ45 port and remotely control the projector, as well as the supported commands for these external devices, please contact the Support-Service directly.*

Baud Rate

Set the baud rate for Serial Port In and Serial Port Out. The available options are 1200, 2400, 4800, 9600, 19200, 38400, 57600, and 115200.

Reset

Reset all network settings to default factory values.

USING THE PROJECTOR

Using the web control panel

The Web control panel allows the user to configure various projector settings using a web browser from any personal computer or mobile devices.

System Requirements

To use the web control panel, make sure your devices and software meet the minimum system requirements.

- RJ45 cable (CAT-5e) or wireless dongle
- PC, laptop, mobile phone, or tablet installed with a web browser
- Compatible web browsers:
 - Microsoft Edge 40 or higher version
 - Firefox 57 or higher version
 - Chrome 63 or higher version

Overview of the web control panel

Configure the projector settings using web browser.

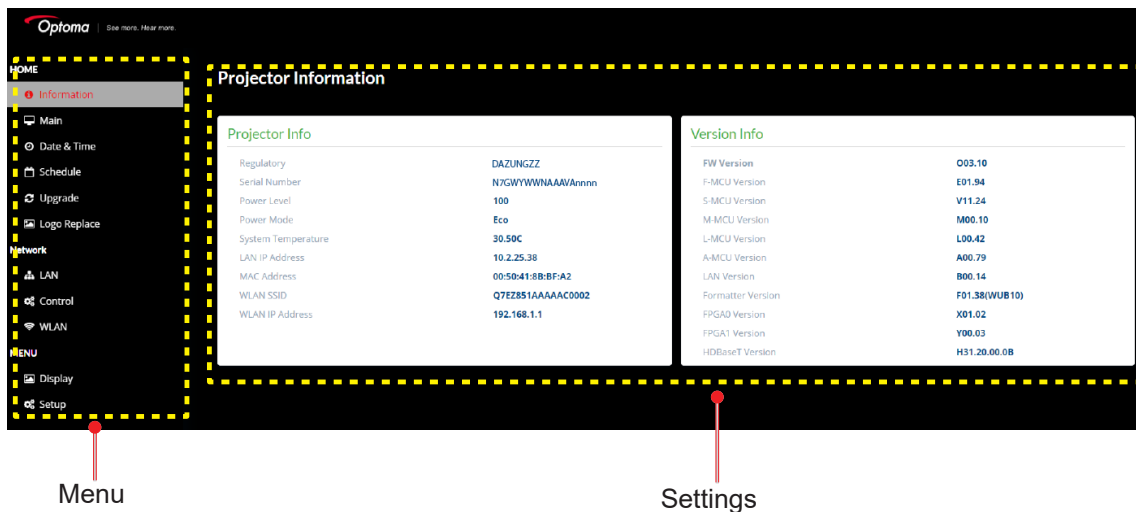

Menu	Description
HOME	View the projector information and firmware version details.
IMAGE	To configure image settings.
DISPLAY	To configure the settings to properly project images according to your installation circumstances.
INPUT SETTINGS	To configure the projector input settings.
DEVICE SETUP	To configure the system settings for the projector.
COMMUNICATION	Communication menu is used to configure the settings that allow the projector to communicate with other projectors or control devices.
INFORMATION	View the projector information about its status and settings. The projector information is read only.

USING THE PROJECTOR

Accessing the web control panel

When network is available, connect the projector and the computer to the same network. Use the projector address as the web URL to open the web control panel in a browser.

1. Check the projector address using the OSD menu.
 - On a wired network, select **Network > LAN > IP Address**.

Note: Make sure DHCP is enabled.

 - On a wireless network, select **Network > WLAN > Gateway**.
2. Open a web browser and type the projector address in the address bar.
3. The web page redirects to the web control panel.
4. In the Username field, type the username: admin(default) In the Password field, type the password.: Device serial number(default)

Note: It is needed to change the username and password once you have logged in. It is also advised to use a strong password.

When network is not available, refer to “Directly connect the projector to a computer” on page 72.

Directly connect the projector to a computer

When network is not available, connect the projector to the computer directly using a RJ-45 cable, and configure the network settings manually.

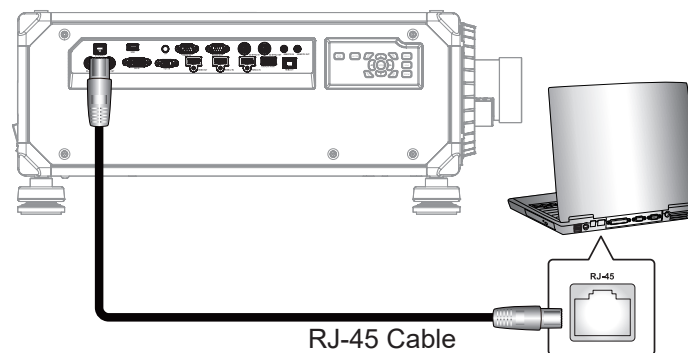

1. Assign IP address to the projector
 - From the OSD menu, select **Network > LAN**.
 - Turn off DHCP, and manually set the projector's IP Address, Subnet Mask, and Gateway.
 - Press **Enter** to confirm the settings.
2. Assign IP address to the computer
 - Set the Default Gateway and Subnet Mask of the computer to match the projector.
 - Set the IP address of the computer to match the first three numbers of the projector.
For example, if the projector IP address is 192.168.000.100, set the computer IP address to 192.168.000.xxx, where xxx is not 100.
3. Open a web browser and type the projector address in the address bar.
4. The web page redirects to the web control panel.

USING THE PROJECTOR

Using RS232 command by Telnet

This projector supports using RS232 commands through Telnet connection.

1. Set up a direct connection between the projector and computer. Refer to *Directly connect the projector to a computer* on page 72.
2. Disable the firewall on the computer.
3. Open the command dialogue on the computer. For Windows 7 operating system, select **Start > All Programs > Accessories > Command Prompt**.
4. Input the command "telnet ttt.xxx.yyy.zzz 23".
Replace "ttt.xxx.yyy.zzz" with the projector IP address.
5. Press **Enter** on the computer keyboard.

Specification for RS232 by Telnet

- Telnet: TCP
- Telnet port: 23 (contact service team for more details)
- Telnet utility: Windows "TELNET.exe" (console mode).
- Disconnection for RS232-by-Telnet control normally: Close
- Below are the limitations for using Windows Telnet utility directly after TELNET connection is ready:
 - There is less than 50 bytes for successive network payload for Telnet-Control application.
 - There is less than 26 bytes for one complete RS232 command for Telnet-Control.
 - Minimum delay for next RS232 command must be more than 200 (ms).Information menu.

Info menu

View the projector information about its status and settings. The projector information is read only.

Submenus

- Device
- System Status
- Communication
- Signal
- Backup Input
- Firmware Version

ADDITIONAL INFORMATION

Compatible resolutions

Timing table

Signal Type	Signal Format	Resolution	Aspect Ratio		V Sync (Hz)	VGA	
						RGB	YPbPr
PC	VGA	640 x 350	1.33	16:10	85	V	NA
		640 x 400			85	NA	NA
		640 x 480			60	NA	NA
			72	V	NA		
			75	V	NA		
			85	V	NA		
			70	V	NA		
		720 x 400	1.8	9:5	85	V	NA
		SVGA	800 x 600	1.33	4:3	60	V
	72					V	NA
	75					V	NA
	85					V	NA
	120					NA	NA
	832 x 624		1.33	4:3	75	V	NA
	848 x 480	60			V	NA	
	XGA	1024 x 768	1.33	4:3	60	NA	NA
					70	V	NA
					75	V	NA
					85	V	NA
					120	NA	NA
	SXGA	1152 x 864	1.33	4:3	75	V	NA
		1152 x 870	1.32		75	V	NA
	WXGA	1280 x 768	1.67	5:3	60	V	NA
					75	V	NA
					85	V	NA
	WXGA	1280 x 800	1.6	16:10	60	V	NA
					75	V	NA
					85	V	NA
	SXGA	1280x960	1.33	4:3	60	NA	NA
					85	NA	NA
		1280 x 1024	1.25	5:4	60	V	NA
					75	V	NA
	WXGA	1360 x 765	1.78	16:9	85	NA	NA
		1360 x 768			60	V	NA
		1366 x 768			60	NA	NA
	SXGA+	1400 x 1050	1.33	4:3	60	NA	NA
WXGA+	1440 x 900	1.6	16:10	60	V	NA	
				75	V	NA	
				85	NA	NA	
WXGA++	1600 x 900	1.78	16:9	60	V	NA	
UXGA	1600 x 1200	1.33	4:3	50	NA	NA	
				60	NA	NA	
WSXGA+	1680 x 1050	1.6	16:10	60	NA	NA	

ADDITIONAL INFORMATION

Signal Type	Signal Format	Resolution	Aspect Ratio		V Sync (Hz)	VGA	
						RGB	YPbPr
PC	WUXGA RB	1920 x 1200RB	1.6	16:10	50	V	NA
					60	NA	NA
	2K	2560 x 1440RB	1.78	16:9	60	NA	NA
TV	SDTV (480i)	720 x 480	1.5	3:2	59.94	V	NA
	SDTV (480i)	720 x 480	1.5	3:2	60	V	NA
	SDTV (576i)	720 x 576	1.25	5:4	50	V	NA
	EDTV (480p)	720 x 480	1.5	3:2	59.94	V	NA
	EDTV (480p)	720 x 480	1.5	3:2	60	V	NA
	EDTV (576p)	720 x 576	1.25	5:4	50	V	NA
	HDTV (1080i)	1920 x 1080	1.78	16:9	50	V	NA
					59.94	V	NA
					60	V	NA
	HDTV (720p)	1280 x 720	1.78	16:9	50	V	NA
					59.94	V	NA
					60	V	NA
	HDTV (1080p)	1920 x 1080	1.78	16:9	120	NA	NA
					23.98	V	NA
					24	V	NA
					25	V	NA
					29.97	V	NA
					30	V	NA
50					NA	NA	
59.94	NA	NA					
60	NA	NA					
SD-SDI	SDTV (480i)	720 x 480	1.5	3:2	59.94	NA	NA
	SDTV (576i)	720 x 576	1.25	5:4	50	NA	NA
HD-SDI	HDTV (720p)	1280 x 720	1.78	16:9	50	NA	NA
					59.94	NA	NA
					60	NA	NA
	HDTV (1080i)	1920 x 1080	1.78	16:9	50	NA	NA
					59.94	NA	NA
					60	NA	NA
	HDTV (1080p)	1920 x 1080	1.78	16:9	23.98	NA	NA
					24	NA	NA
					25	NA	NA
					29.97	NA	NA
					30	NA	NA
	HDTV (1080sF)	1920 x 1080	1.78	16:9	25	NA	NA
29.97					NA	NA	
30					NA	NA	
3GA-SDI	HDTV (1080p)	1920 x 1080	1.78	16:9	50	NA	NA
					59.94	NA	NA
					60	NA	NA
3GB-SDI	HDTV (1080p)	1920x1080with 352M Payload ID	1.78	16:9	50	NA	NA
					59.94	NA	NA
					60	NA	NA
Mandatory 3D	Frame Packing (1080p)	1920 x 1080	1.78	16:9	23.98	NA	NA
					24	NA	NA

ADDITIONAL INFORMATION

Signal Type	Signal Format	Resolution	Aspect Ratio		V Sync (Hz)	VGA	
						RGB	YPbPr
Mandatory 3D	Frame Packing (720p)	1280 x 720	1.78	16:9	50	NA	NA
					59.94	NA	NA
					60	NA	NA
	Side by Side (1080i)	1920 x 1080	1.78	16:9	50	NA	NA
					59.94	NA	NA
					60	NA	NA
	Side by Side (1080p)	1920 x 1080	1.78	16:9	24	NA	NA
					50	NA	NA
					59.9	NA	NA
					60	NA	NA
	Top and Bottom (720p)	1280 x 720	1.78	16:9	50	NA	NA
					59.94	NA	NA
					60	NA	NA
	Top and Bottom (1080p)	1920 x 1080	1.78	16:9	23.98	NA	NA
					24	NA	NA
					59.9	NA	NA
60					NA	NA	
Frame Sequential 3D	SVGA	800 x 600	1.33	4:3	120	NA	NA
	XGA	1024 x 768	1.33	4:3	120	NA	NA
	HDTV	1280 x 720	1.78	16:9	120	NA	NA
	HDTV	1280 x 800	1.78	16:9	120	NA	NA
	1080p	1920 x 1080	1.78	16:9	120	NA	NA
					60	NA	NA
					50	NA	NA
	WUXGA	1920 x 1200	1.6	16:10	120	NA	NA
60					NA	NA	
4K	3840 x 2160	3840 x 2160	1.78	16:9	24	NA	NA
					25	NA	NA
					30	NA	NA
					50	NA	NA
	4096 x 2160 SMPTE	4096 x 2160	1.9	N/A	60	NA	NA
					24	NA	NA
					25	NA	NA
					30	NA	NA
					50	NA	NA
					60	NA	NA

Note:

- “V” means supported and “NA” means not supported.
- “RB” means “reduced blanking”.

ADDITIONAL INFORMATION

Signal Type	Signal Format	Resolution	Aspect Ratio		V Sync (Hz)	HDMI 1/HDMI 2								
						RGB			YCbCr 4:4:4			YCbCr 4:2:2		
						8 bit	10 bit	12 bit	8 bit	10 bit	12 bit	8 bit		
PC	VGA	640 x 350	1.33	16:10	85	V	V	V	V	V	V	V		
		640 x 400			85	V	V	V	V	V	V	V		
		640 x 480			4:3	60	V	V	V	V	V	V	V	
						72	V	V	V	V	V	V	V	
			75	V		V	V	V	V	V	V			
		720 x 400	1.8	9:5	85	V	V	V	V	V	V	V		
					70	V	V	V	V	V	V	V		
		SVGA	800 x 600	1.33	4:3	85	V	V	V	V	V	V	V	
	120					V	V	V	V	V	V	V		
	832 x 624					1.33	4:3	75	V	V	V	V	V	V
								60	V	V	V	V	V	V
	848 x 480		60	V	V	V	V	V	V					
	XGA		1024 x 768	1.33	4:3	60	V	V	V	V	V	V	V	
		70				V	V	V	V	V	V	V		
		75				V	V	V	V	V	V	V		
		85				V	V	V	V	V	V	V		
	SXGA	1152 x 864	1.33	4:3	120	V	V	V	V	V	V	V		
					75	V	V	V	V	V	V	V		
	1152 x 870	1.32	4:3	75	V	V	V	V	V	V	V			
				75	V	V	V	V	V	V	V			
	WXGA	1280 x 768	1.67	5:3	60	V	V	V	V	V	V	V		
					75	V	V	V	V	V	V	V		
					85	V	V	V	V	V	V	V		
	WXGA	1280 x 800	1.6	16:10	60	V	V	V	V	V	V	V		
					75	V	V	V	V	V	V	V		
					85	V	V	V	V	V	V	V		
	SXGA	1280x960	1.33	4:3	60	V	V	V	V	V	V	V		
					85	V	V	V	V	V	V	V		
		1280 x 1024	1.25	5:4	60	V	V	V	V	V	V	V		
					75	V	V	V	V	V	V	V		
	WXGA	1360 x 765	1.78	16:9	85	V	V	V	V	V	V	V		
					60	V	NA	NA	V	NA	NA	NA		
					60	V	V	V	V	V	V	V		
	1366 x 768	1.78	16:9	16:9	60	V	V	V	V	V	V	V		
					60	V	V	V	V	V	V	NA		
	SXGA+	1400 x 1050	1.33	4:3	60	V	V	V	V	V	V	V		
WXGA+	1440 x 900	1.6	16:10	60	V	V	V	V	V	V	V			
				75	V	V	V	V	V	V	V			
				85	V	V	V	V	V	V	V			
WXGA++	1600 x 900	1.78	16:9	60	V	V	V	V	V	V	V			
UXGA	1600 x 1200	1.33	4:3	60	V	V	V	V	V	V	V			
				50	V	V	V	V	V	V	V			
WSXGA+	1680 x 1050	1.6	16:10	60	V	V	V	V	V	V	V			
WUXGA RB	1920 x 1200RB	1.6	16:10	60	V	V	V	V	V	V	V			
				50	V	V	V	V	V	V	V			
60	V	V	V	V	V	V	V	V						

ADDITIONAL INFORMATION

Signal Type	Signal Format	Resolution	Aspect Ratio		V Sync (Hz)	HDMI 1/HDMI 2							
						RGB			YCbCr 4:4:4			YCbCr 4:2:2	
						8 bit	10 bit	12 bit	8 bit	10 bit	12 bit	8 bit	
PC	2K	2560 x 1440RB	1.78	16:9	60	V	V	V	V	V	V	V	
TV	SDTV (480i)	720 x 480	1.5	3:2	59.94	V	V	V	V	V	V	V	
	SDTV (480i)	720 x 480	1.5	3:2	60	V	V	V	V	V	V	V	
	SDTV (576i)	720 x 576	1.25	5:4	50	V	V	V	V	V	V	V	
	EDTV (480p)	720 x 480	1.5	3:2	59.94	V	V	V	V	V	V	V	
	EDTV (480p)	720 x 480	1.5	3:2	60	V	V	V	V	V	V	V	
	EDTV (576p)	720 x 576	1.25	5:4	50	V	V	V	V	V	V	V	
	HDTV (1080i)	1920 x 1080	1.78	16:9	50	V	V	V	V	V	V	V	V
					59.94	V	V	V	V	V	V	V	V
					60	V	V	V	V	V	V	V	V
	HDTV (720p)	1280 x 720	1.78	16:9	50	V	V	V	V	V	V	V	V
					59.94	V	V	V	V	V	V	V	V
					60	V	V	V	V	V	V	V	V
	HDTV (1080p)	1920 x 1080	1.78	16:9	120	V	V	V	V	V	V	V	V
					23.98	V	V	V	V	V	V	V	V
					24	V	V	V	V	V	V	V	V
25					V	V	V	V	V	V	V	V	
29.97					V	V	V	V	V	V	V	V	
30					V	V	V	V	V	V	V	V	
50					V	V	V	V	V	V	V	V	
59.94	V	V	V	V	V	V	V	V					
60	V	V	V	V	V	V	V	V					
SD-SDI	SDTV (480i)	720 x 480	1.5	3:2	59.94	NA	NA	NA	NA	NA	NA	NA	
	SDTV (576i)	720 x 576	1.25	5:4	50	NA	NA	NA	NA	NA	NA	NA	
HD-SDI	HDTV (720p)	1280 x 720	1.78	16:9	50	NA	NA	NA	NA	NA	NA	NA	
					59.94	NA	NA	NA	NA	NA	NA	NA	
					60	NA	NA	NA	NA	NA	NA	NA	
	HDTV (1080i)	1920 x 1080	1.78	16:9	50	NA	NA	NA	NA	NA	NA	NA	
					59.94	NA	NA	NA	NA	NA	NA	NA	
					60	NA	NA	NA	NA	NA	NA	NA	
	HDTV (1080p)	1920 x 1080	1.78	16:9	23.98	NA	NA	NA	NA	NA	NA	NA	
					24	NA	NA	NA	NA	NA	NA	NA	
					25	NA	NA	NA	NA	NA	NA	NA	
					29.97	NA	NA	NA	NA	NA	NA	NA	
					30	NA	NA	NA	NA	NA	NA	NA	
	HDTV (1080sF)	1920 x 1080	1.78	16:9	25	NA	NA	NA	NA	NA	NA	NA	
29.97					NA	NA	NA	NA	NA	NA	NA		
30					NA	NA	NA	NA	NA	NA	NA		
3GA-SDI	HDTV (1080p)	1920 x 1080	1.78	16:9	50	NA	NA	NA	NA	NA	NA	NA	
					59.94	NA	NA	NA	NA	NA	NA	NA	
					60	NA	NA	NA	NA	NA	NA	NA	
3GB-SDI	HDTV (1080p)	1920x1080 with 352M Payload ID	1.78	16:9	50	NA	NA	NA	NA	NA	NA	NA	
					59.94	NA	NA	NA	NA	NA	NA	NA	
					60	NA	NA	NA	NA	NA	NA	NA	
Mandatory 3D	Frame Packing (1080p)	1920 x 1080	1.78	16:9	23.98	V	V	V	V	V	V	V	
					24	V	V	V	V	V	V	V	V

ADDITIONAL INFORMATION

Signal Type	Signal Format	Resolution	Aspect Ratio		V Sync (Hz)	HDMI 1/HDMI 2							
						RGB			YCbCr 4:4:4			YCbCr 4:2:2	
						8 bit	10 bit	12 bit	8 bit	10 bit	12 bit	8 bit	
Mandatory 3D	Frame Packing (720p)	1280 x 720	1.78	16:9	50	V	V	V	V	V	V	V	
					59.94	V	V	V	V	V	V	V	
					60	V	V	V	V	V	V	V	
	Side by Side (1080i)	1920 x 1080	1.78	16:9	50	V	V	V	V	V	V	V	
					59.94	V	V	V	V	V	V	V	
					60	V	V	V	V	V	V	V	
	Side by Side (1080p)	1920 x 1080	1.78	16:9	24	V	V	V	V	V	V	V	
					50	V	V	V	V	V	V	V	
					59.9	V	V	V	V	V	V	V	
					60	V	V	V	V	V	V	V	
	Top and Bottom (720p)	1280 x 720	1.78	16:9	50	V	V	V	V	V	V	V	
					59.94	V	V	V	V	V	V	V	
					60	V	V	V	V	V	V	V	
	Top and Bottom (1080p)	1920 x 1080	1.78	16:9	23.98	V	V	V	V	V	V	V	
					24	V	V	V	V	V	V	V	
					59.9	V	V	V	V	V	V	V	
60					V	V	V	V	V	V	V		
Frame Sequential 3D	SVGA	800 x 600	1.33	4:3	120	V	V	V	V	V	V	V	
	XGA	1024 x 768	1.33	4:3	120	V	V	V	V	V	V	V	
	HDTV	1280 x 720	1.78	16:9	120	V	V	V	V	V	V	V	
	HDTV	1280 x 800	1.78	16:9	120	V	V	V	V	V	V	V	
	1080p	1920 x 1080	1.78	16:9	120	V	V	V	V	V	V	V	V
					60	V	V	V	NA	V	V	X	
					50	V	V	V	V	V	V	X	
	WUXGA	1920 x 1200	1.6	16:10	120	V	V	V	V	V	V	V	
60					V	V	V	V	V	V	V		
4K	3840 x 2160	3840 x 2160	1.78	16:9	24	V	V	V	V	V	V	V	
					25	V	V	V	V	V	V	V	
					30	V	V	V	V	V	V	V	
					50	V	NA	NA	V	NA	NA	V	
					60	V	NA	NA	V	NA	NA	V	
	4096 x 2160 SMPTE	4096 x 2160	1.9	N/A	24	V	V	V	V	V	V	V	
					25	V	V	V	V	V	V	V	
					30	V	V	V	V	V	V	V	
					50	V	NA	NA	V	NA	NA	V	
					60	V	NA	NA	V	NA	NA	V	

Note:

- "V" means supported and "NA" means not supported.
- "RB" means "reduced blanking".

ADDITIONAL INFORMATION

Signal Type	Signal Format	Resolution	Aspect Ratio		V Sync (Hz)	DVI						
						RGB			YCbCr 4:4:4			YCbCr 4:2:2
						8 bit	10 bit	12 bit	8 bit	10 bit	12 bit	8 bit
PC	VGA	640 x 350	1.33	16:10	85	V	V	V	V	V	V	V
		640 x 400			85	V	V	V	V	V	V	V
		640 x 480	4:3	60	V	V	V	V	V	V	V	
				72	V	V	V	V	V	V	V	
				75	V	V	V	V	V	V	V	
		720 x 400	1.8	9:5	85	V	V	V	V	V	V	V
					70	V	V	V	V	V	V	V
		SVGA	800 x 600	1.33	4:3	85	V	V	V	NA	NA	NA
	120					NA	NA	NA	NA	NA	NA	NA
	75					NA	NA	NA	NA	NA	NA	V
	60					V	V	V	NA	NA	NA	V
	832 x 624		1.33	4:3	60	V	V	V	V	V	V	V
					848 x 480	75	V	V	V	NA	NA	NA
	XGA	1024 x 768	1.33	4:3	60	V	V	V	V	V	V	V
					70	NA	NA	NA	NA	NA	NA	V
					75	NA	NA	NA	V	V	V	V
					85	V	V	V	V	V	V	V
					120	NA	NA	NA	NA	NA	NA	NA
	SXGA	1152 x 864	1.33	4:3	75	V	V	V	V	V	V	V
		1152 x 870	1.32		75	V	V	V	V	V	V	V
	WXGA	1280 x 768	1.67	5:3	60	NA	NA	NA	V	NA	NA	V
					75	V	V	V	V	V	V	V
					85	V	V	V	V	V	V	V
	WXGA	1280 x 800	1.6	16:10	60	NA	NA	NA	V	V	V	V
					75	V	V	V	V	V	V	V
					85	V	V	V	V	V	V	V
	SXGA	1280x960	1.33	4:3	60	V	V	V	V	V	V	V
					85	V	V	V	V	V	V	V
		1280 x 1024	1.25	5:4	60	V	V	V	V	V	V	V
					75	V	V	V	V	V	V	V
	WXGA	1360 x 765	1.78	16:9	60	V	NA	NA	V	NA	NA	NA
		1360 x 768			60	V	V	V	V	V	V	V
		1366 x 768			60	V	V	V	V	V	V	V
	SXGA+	1400 x 1050	1.33	4:3	60	V	V	V	V	V	V	V
	WXGA+	1440 x 900	1.6	16:10	60	V	V	V	V	V	V	V
					75	V	V	V	V	V	V	V
85					V	V	V	V	V	V	V	
WXGA++	1600 x 900	1.78	16:9	60	V	V	V	V	V	V	V	
UXGA	1600 x 1200	1.33	4:3	50	V	V	V	V	V	V	V	
				60	V	V	V	V	V	V	V	
WSXGA+	1680 x 1050	1.6	16:10	60	V	V	V	V	V	V	V	
WUXGA RB	1920 x 1200RB	1.6	16:10	50	V	V	V	V	V	V	V	
				60	V	V	V	V	V	V	V	

ADDITIONAL INFORMATION

Signal Type	Signal Format	Resolution	Aspect Ratio		V Sync (Hz)	DVI							
						RGB			YCbCr 4:4:4			YCbCr 4:2:2	
						8 bit	10 bit	12 bit	8 bit	10 bit	12 bit	8 bit	
PC	2K	2560 x 1440RB	1.78	16:9	60	NA	NA	NA	NA	NA	NA	NA	
TV	SDTV (480i)	720 x 480	1.5	3:2	59.94	V	V	V	V	V	V	V	
	SDTV (480i)	720 x 480	1.5	3:2	60	V	V	V	V	V	V	V	
	SDTV (576i)	720 x 576	1.25	5:4	50	V	V	V	V	V	V	V	
	EDTV (480p)	720 x 480	1.5	3:2	59.94	V	V	V	V	V	V	V	
	EDTV (480p)	720 x 480	1.5	3:2	60	V	V	V	V	V	V	V	
	EDTV (576p)	720 x 576	1.25	5:4	50	V	V	V	V	V	V	V	
	HDTV (1080i)	1920 x 1080	1.78	16:9	50	V	V	V	V	V	V	V	V
					59.94	V	V	V	V	V	V	V	V
					60	V	V	V	V	V	V	V	V
	HDTV (720p)	1280 x 720	1.78	16:9	50	V	V	V	V	V	V	V	V
					59.94	V	V	V	V	V	V	V	V
					60	V	V	V	V	V	V	V	V
	HDTV (1080p)	1920 x 1080	1.78	16:9	120	NA	NA	NA	NA	NA	NA	NA	NA
					23.98	V	V	V	V	V	V	V	V
					24	V	V	V	V	V	V	V	V
					25	V	V	V	V	V	V	V	V
29.97					V	V	V	V	V	V	V	V	
30					V	V	V	V	V	V	V	V	
50					V	V	V	V	V	V	V	V	
59.94	V	V	V	V	V	V	V	V					
60	V	V	V	V	V	V	V	V					
SD-SDI	SDTV (480i)	720 x 480	1.5	3:2	59.94	NA	NA	NA	NA	NA	NA	NA	
	SDTV (576i)	720 x 576	1.25	5:4	50	NA	NA	NA	NA	NA	NA	NA	
HD-SDI	HDTV (720p)	1280 x 720	1.78	16:9	50	NA	NA	NA	NA	NA	NA	NA	
					59.94	NA	NA	NA	NA	NA	NA	NA	
					60	NA	NA	NA	NA	NA	NA	NA	
	HDTV (1080i)	1920 x 1080	1.78	16:9	50	NA	NA	NA	NA	NA	NA	NA	
					59.94	NA	NA	NA	NA	NA	NA	NA	
					60	NA	NA	NA	NA	NA	NA	NA	
	HDTV (1080p)	1920 x 1080	1.78	16:9	23.98	NA	NA	NA	NA	NA	NA	NA	
					24	NA	NA	NA	NA	NA	NA	NA	
					25	NA	NA	NA	NA	NA	NA	NA	
					29.97	NA	NA	NA	NA	NA	NA	NA	
					30	NA	NA	NA	NA	NA	NA	NA	
	HDTV (1080sF)	1920 x 1080	1.78	16:9	25	NA	NA	NA	NA	NA	NA	NA	
29.97					NA	NA	NA	NA	NA	NA	NA		
30					NA	NA	NA	NA	NA	NA	NA		
3GA-SDI	HDTV (1080p)	1920 x 1080	1.78	16:9	50	NA	NA	NA	NA	NA	NA	NA	
					59.94	NA	NA	NA	NA	NA	NA	NA	
					60	NA	NA	NA	NA	NA	NA	NA	
3GB-SDI	HDTV (1080p)	1920x1080 with 352M Payload ID	1.78	16:9	50	NA	NA	NA	NA	NA	NA	NA	
					59.94	NA	NA	NA	NA	NA	NA	NA	
					60	NA	NA	NA	NA	NA	NA	NA	
Mandatory 3D	Frame Packing (1080p)	1920 x 1080	1.78	16:9	23.98	NA	NA	NA	NA	NA	NA	NA	
					24	NA	NA	NA	NA	NA	NA	NA	

ADDITIONAL INFORMATION

Signal Type	Signal Format	Resolution	Aspect Ratio		V Sync (Hz)	DVI							
						RGB			YCbCr 4:4:4			YCbCr 4:2:2	
						8 bit	10 bit	12 bit	8 bit	10 bit	12 bit	8 bit	
Mandatory 3D	Frame Packing (720p)	1280 x 720	1.78	16:9	50	NA	NA	NA	NA	NA	NA	NA	
					59.94	NA	NA	NA	NA	NA	NA	NA	
					60	NA	NA	NA	NA	NA	NA	NA	
	Side by Side (1080i)	1920 x 1080	1.78	16:9	50	NA	NA	NA	NA	NA	NA	NA	
					59.94	NA	NA	NA	NA	NA	NA	NA	
					60	NA	NA	NA	NA	NA	NA	NA	
	Side by Side (1080p)	1920 x 1080	1.78	16:9	24	NA	NA	NA	NA	NA	NA	NA	
					50	NA	NA	NA	NA	NA	NA	NA	
					59.9	NA	NA	NA	NA	NA	NA	NA	
	Top and Bottom (720p)	1280 x 720	1.78	16:9	50	NA	NA	NA	NA	NA	NA	NA	
					59.94	NA	NA	NA	NA	NA	NA	NA	
					60	NA	NA	NA	NA	NA	NA	NA	
	Top and Bottom (1080p)	1920 x 1080	1.78	16:9	23.98	NA	NA	NA	NA	NA	NA	NA	
					24	NA	NA	NA	NA	NA	NA	NA	
					59.9	NA	NA	NA	NA	NA	NA	NA	
	Frame Sequential 3D	SVGA	800 x 600	1.33	4:3	120	NA	NA	NA	NA	NA	NA	NA
XGA		1024 x 768	1.33	4:3	120	NA	NA	NA	NA	NA	NA	NA	
HDTV		1280 x 720	1.78	16:9	120	NA	NA	NA	NA	NA	NA	NA	
HDTV		1280 x 800	1.78	16:9	120	NA	NA	NA	NA	NA	NA	NA	
1080p		1920 x 1080	1.78	16:9	120	NA	NA	NA	NA	NA	NA	NA	NA
					60	NA	NA	NA	NA	NA	NA	NA	NA
					50	NA	NA	NA	NA	NA	NA	NA	NA
WUXGA		1920 x 1200	1.6	16:10	120	NA	NA	NA	NA	NA	NA	NA	
					60	NA	NA	NA	NA	NA	NA	NA	NA
4K	3840 x 2160	3840 x 2160	1.78	16:9	24	NA	NA	NA	NA	NA	NA	NA	
					25	NA	NA	NA	NA	NA	NA	NA	
					30	NA	NA	NA	NA	NA	NA	NA	
					50	NA	NA	NA	NA	NA	NA	NA	
					60	NA	NA	NA	NA	NA	NA	NA	
	4096 x 2160 SMPTE	4096 x 2160	1.9	N/A	24	NA	NA	NA	NA	NA	NA	NA	
					25	NA	NA	NA	NA	NA	NA	NA	
					30	NA	NA	NA	NA	NA	NA	NA	
					50	NA	NA	NA	NA	NA	NA	NA	
					60	NA	NA	NA	NA	NA	NA	NA	

Note:

- "V" means supported and "NA" means not supported.
- "RB" means "reduced blanking".

ADDITIONAL INFORMATION

Signal Type	Signal Format	Resolution	Aspect Ratio		V Sync (Hz)	3G-SDI				
						YCbCr 4:2:2				
						10 bit				
PC	VGA	640 x 350	1.33	16:10	85	NA				
		640 x 400			85	NA				
		640 x 480		4:3	60	NA				
					72	NA				
		720 x 400	1.8	9:5	75	NA				
					85	NA				
		70	85	NA	NA	NA				
							SVGA	800 x 600	1.33	4:3
	72	NA								
	75	NA								
	85	NA								
	120	85	NA	NA	NA					
						832 x 624	1.33	4:3	75	NA
	848 x 480	60	NA							
	XGA	1024 x 768	1.33	4:3	60	NA				
					70	NA				
					75	NA				
					85	NA				
					120	NA				
	SXGA	1152 x 864	1.33	4:3	75	NA				
		1152 x 870	1.32		75	NA				
	WXGA	1280 x 768	1.67	5:3	60	NA				
					75	NA				
					85	NA				
	WXGA	1280 x 800	1.6	16:10	60	NA				
					75	NA				
					85	NA				
	SXGA	1280x960	1.33	4:3	60	NA				
					85	NA				
		1280 x 1024	1.25	5:4	60	NA				
					75	NA				
	85	NA	NA	NA	NA					
WXGA						1360 x 765	1.78	16:9	60	NA
						1360 x 768			60	NA
	1366 x 768	60	NA							
SXGA+	1400 x 1050	1.33	4:3	60	NA					
WXGA+	1440 x 900	1.6	16:10	60	NA					
				75	NA					
				85	NA					
WXGA++	1600 x 900	1.78	16:9	60	NA					
UXGA	1600 x 1200	1.33	4:3	50	NA					
				60	NA					
WSXGA+	1680 x 1050	1.6	16:10	60	NA					
WUXGA RB	1920 x 1200RB	1.6	16:10	50	NA					
				60	NA					
2K	2560 x 1440RB	1.78	16:9	60	NA					

ADDITIONAL INFORMATION

Signal Type	Signal Format	Resolution	Aspect Ratio		V Sync (Hz)	3G-SDI
						YCbCr 4:2:2
						10 bit
TV	SDTV (480i)	720 x 480	1.5	3:2	59.94	NA
	SDTV (480i)	720 x 480	1.5	3:2	60	NA
	SDTV (576i)	720 x 576	1.25	5:4	50	NA
	EDTV (480p)	720 x 480	1.5	3:2	59.94	NA
	EDTV (480p)	720 x 480	1.5	3:2	60	NA
	EDTV (576p)	720 x 576	1.25	5:4	50	NA
	HDTV (1080i)	1920 x 1080	1.78	16:9	50	NA
					59.94	NA
					60	NA
	HDTV (720p)	1280 x 720	1.78	16:9	50	NA
					59.94	NA
					60	NA
	HDTV (1080p)	1920 x 1080	1.78	16:9	120	NA
					23.98	NA
					24	NA
					25	NA
					29.97	NA
					30	NA
50					NA	
59.94	NA					
60	NA					
SD-SDI	SDTV (480i)	720 x 480	1.5	3:2	59.94	V
	SDTV (576i)	720 x 576	1.25	5:4	50	V
HD-SDI	HDTV (720p)	1280 x 720	1.78	16:9	50	V
					59.94	V
					60	V
	HDTV (1080i)	1920 x 1080	1.78	16:9	50	V
					59.94	V
					60	V
	HDTV (1080p)	1920 x 1080	1.78	16:9	23.98	V
					24	V
					25	V
					29.97	V
					30	V
	HDTV (1080sF)	1920 x 1080	1.78	16:9	25	V
29.97					V	
30					V	
3GA-SDI	HDTV (1080p)	1920 x 1080	1.78	16:9	50	V
					59.94	V
					60	V
3GB-SDI	HDTV (1080p)	1920x1080 with 352M Payload ID	1.78	16:9	50	V
					59.94	V
					60	V
Mandatory 3D	Frame Packing (1080p)	1920 x 1080	1.78	16:9	23.98	NA
					24	NA

ADDITIONAL INFORMATION

Signal Type	Signal Format	Resolution	Aspect Ratio		V Sync (Hz)	3G-SDI
						YCbCr 4:2:2
						10 bit
Mandatory 3D	Frame Packing (720p)	1280 x 720	1.78	16:9	50	NA
					59.94	NA
					60	NA
	Side by Side (1080i)	1920 x 1080	1.78	16:9	50	NA
					59.94	NA
					60	NA
	Side by Side (1080p)	1920 x 1080	1.78	16:9	24	NA
					50	NA
					59.9	NA
					60	NA
	Top and Bottom (720p)	1280 x 720	1.78	16:9	50	NA
					59.94	NA
					60	NA
	Top and Bottom (1080p)	1920 x 1080	1.78	16:9	23.98	NA
					24	NA
					59.9	NA
60					NA	
Frame Sequential 3D	SVGA	800 x 600	1.33	4:3	120	NA
	XGA	1024 x 768	1.33	4:3	120	NA
	HDTV	1280 x 720	1.78	16:9	120	NA
	HDTV	1280 x 800	1.78	16:9	120	NA
	1080p	1920 x 1080	1.78	16:9	120	NA
					60	NA
					50	NA
	WUXGA	1920 x 1200	1.6	16:10	120	NA
60					NA	
4K	3840 x 2160	3840 x 2160	1.78	16:9	24	NA
					25	NA
					30	NA
					50	NA
					60	NA
	4096 x 2160 SMPTE	4096 x 2160	1.9	N/A	24	NA
					25	NA
					30	NA
					50	NA
					60	NA

Note:

- “V” means supported and “NA” means not supported.
- “RB” means “reduced blanking”.

ADDITIONAL INFORMATION

Signal Type	Signal Format	Resolution	Aspect Ratio		V Sync (Hz)	HDBaseT						
						RGB			YCbCr 4:4:4			YCbCr 4:2:2
						8 bit	10 bit	12 bit	8 bit	10 bit	12 bit	8 bit
PC	VGA	640 x 350	1.33	16:10	85	V	V	V	V	V	V	V
		640 x 400			85	V	V	V	V	V	V	V
		640 x 480		4:3	60	V	V	V	V	V	V	V
					72	V	V	V	V	V	V	V
			75		V	V	V	V	V	V	V	
		720 x 400	1.8	9:5	85	V	V	V	V	V	V	V
					70	V	V	V	V	V	V	V
		SVGA	800 x 600	1.33	4:3	85	V	V	V	V	V	V
	120					V	V	V	V	V	V	V
	75					V	V	V	V	V	V	V
	60					V	V	V	V	V	V	V
	832 x 624		1.33	4:3	75	V	V	V	V	V	V	V
					848 x 480	60	V	V	V	V	V	V
	XGA	1024 x 768	1.33	4:3	60	V	V	V	V	V	V	V
					70	V	V	V	V	V	V	V
					75	V	V	V	V	V	V	V
					85	V	V	V	V	V	V	V
	SXGA	1152 x 864	1.33	4:3	120	V	V	V	V	V	V	V
					1152 x 870	75	V	V	V	V	V	V
	WXGA	1280 x 768	1.67	5:3	75	V	V	V	V	V	V	V
					85	V	V	V	V	V	V	V
					60	V	V	V	V	V	V	V
	WXGA	1280 x 800	1.6	16:10	75	V	V	V	V	V	V	V
					85	V	V	V	V	V	V	V
					60	V	V	V	V	V	V	V
	SXGA	1280x960	1.33	4:3	60	V	V	V	V	V	V	V
					85	V	V	V	V	V	V	V
		1280 x 1024	1.25	5:4	60	V	V	V	V	V	V	V
					75	V	V	V	V	V	V	V
	WXGA	1360 x 765	1.78	16:9	85	V	V	V	V	V	V	V
					60	V	NA	NA	V	NA	NA	NA
					60	V	V	V	V	V	V	V
	SXGA+	1400 x 1050	1.33	4:3	60	V	V	V	V	V	V	V
					60	V	V	V	V	V	V	V
					85	V	V	V	V	V	V	V
	WXGA+	1440 x 900	1.6	16:10	60	V	V	V	V	V	V	V
					75	V	V	V	V	V	V	V
					85	V	V	V	V	V	V	V
	WXGA++	1600 x 900	1.78	16:9	60	V	V	V	V	V	V	V
					60	V	V	V	V	V	V	V
60					V	V	V	V	V	V	NA	
UXGA	1600 x 1200	1.33	4:3	50	V	V	V	V	V	V	V	
				60	V	V	V	V	V	NA	V	
WSXGA+	1680 x 1050	1.6	16:10	60	V	V	V	V	V	V	V	
WUXGA RB	1920 x 1200RB	1.6	16:10	50	V	V	V	V	V	V	V	
				60	V	V	V	V	V	NA	V	

ADDITIONAL INFORMATION

Signal Type	Signal Format	Resolution	Aspect Ratio		V Sync (Hz)	HDBaseT							
						RGB			YCbCr 4:4:4			YCbCr 4:2:2	
						8 bit	10 bit	12 bit	8 bit	10 bit	12 bit	8 bit	
PC	2K	2560 x 1440RB	1.78	16:9	60	V	NA	NA	V	NA	NA	V	
TV	SDTV (480i)	720 x 480	1.5	3:2	59.94	V	V	V	V	V	V	V	
	SDTV (480i)	720 x 480	1.5	3:2	60	V	V	V	V	V	V	V	
	SDTV (576i)	720 x 576	1.25	5:4	50	V	V	V	V	V	V	V	
	EDTV (480p)	720 x 480	1.5	3:2	59.94	V	V	V	V	V	V	V	
	EDTV (480p)	720 x 480	1.5	3:2	60	V	V	V	V	V	V	V	
	EDTV (576p)	720 x 576	1.25	5:4	50	V	V	V	V	V	V	V	
	HDTV (1080i)	1920 x 1080	1.78	16:9	50	V	V	V	V	V	V	V	V
					59.94	V	V	V	V	V	V	V	V
					60	V	V	V	V	V	V	V	V
	HDTV (720p)	1280 x 720	1.78	16:9	50	V	V	V	V	V	V	V	V
					59.94	V	V	V	V	V	V	V	V
					60	V	V	V	V	V	V	V	V
	HDTV (1080p)	1920 x 1080	1.78	16:9	120	V	V	V	V	V	V	V	V
					23.98	V	V	V	V	V	V	V	V
					24	V	V	V	V	V	V	V	V
					25	V	V	V	V	V	V	V	V
					29.97	V	V	V	V	V	V	V	V
					30	V	V	V	V	V	V	V	V
50					V	V	V	V	V	V	V	V	
59.94	V	V	V	V	V	V	V	V					
60	V	V	V	V	V	V	V	V	V				
SD-SDI	SDTV (480i)	720 x 480	1.5	3:2	59.94	NA	NA	NA	NA	NA	NA	NA	
	SDTV (576i)	720 x 576	1.25	5:4	50	NA	NA	NA	NA	NA	NA	NA	
HD-SDI	HDTV (720p)	1280 x 720	1.78	16:9	50	NA	NA	NA	NA	NA	NA	NA	
					59.94	NA	NA	NA	NA	NA	NA	NA	
					60	NA	NA	NA	NA	NA	NA	NA	
	HDTV (1080i)	1920 x 1080	1.78	16:9	50	NA	NA	NA	NA	NA	NA	NA	
					59.94	NA	NA	NA	NA	NA	NA	NA	
					60	NA	NA	NA	NA	NA	NA	NA	
	HDTV (1080p)	1920 x 1080	1.78	16:9	23.98	NA	NA	NA	NA	NA	NA	NA	
					24	NA	NA	NA	NA	NA	NA	NA	
					25	NA	NA	NA	NA	NA	NA	NA	
					29.97	NA	NA	NA	NA	NA	NA	NA	
					30	NA	NA	NA	NA	NA	NA	NA	
					50	NA	NA	NA	NA	NA	NA	NA	
HDTV (1080sF)	1920 x 1080	1.78	16:9	25	NA	NA	NA	NA	NA	NA	NA		
				29.97	NA	NA	NA	NA	NA	NA	NA		
				30	NA	NA	NA	NA	NA	NA	NA		
3GA-SDI	HDTV (1080p)	1920 x 1080	1.78	16:9	50	NA	NA	NA	NA	NA	NA	NA	
					59.94	NA	NA	NA	NA	NA	NA	NA	
					60	NA	NA	NA	NA	NA	NA	NA	
3GB-SDI	HDTV (1080p)	1920x1080 with 352M Payload ID	1.78	16:9	50	NA	NA	NA	NA	NA	NA	NA	
					59.94	NA	NA	NA	NA	NA	NA	NA	
					60	NA	NA	NA	NA	NA	NA	NA	
Mandatory 3D	Frame Packing (1080p)	1920 x 1080	1.78	16:9	23.98	V	V	V	V	V	V	V	
					24	V	V	V	V	V	V	V	

ADDITIONAL INFORMATION

Signal Type	Signal Format	Resolution	Aspect Ratio		V Sync (Hz)	HDBaseT						
						RGB			YCbCr 4:4:4			YCbCr 4:2:2
						8 bit	10 bit	12 bit	8 bit	10 bit	12 bit	8 bit
Mandatory 3D	Frame Packing (720p)	1280 x 720	1.78	16:9	50	V	V	V	V	V	V	V
					59.94	V	V	V	V	V	V	V
					60	V	V	V	V	V	V	V
	Side by Side (1080i)	1920 x 1080	1.78	16:9	50	V	V	V	V	V	V	V
					59.94	V	V	V	V	V	V	V
					60	V	V	V	V	V	V	V
	Side by Side (1080p)	1920 x 1080	1.78	16:9	24	V	V	V	V	V	V	V
					50	V	V	V	V	V	V	V
					59.9	V	V	V	V	V	V	V
					60	V	V	V	V	V	V	V
	Top and Bottom (720p)	1280 x 720	1.78	16:9	50	V	V	V	V	V	V	V
					59.94	V	V	V	V	V	V	V
					60	V	V	V	V	V	V	V
	Top and Bottom (1080p)	1920 x 1080	1.78	16:9	23.98	V	V	V	V	V	V	V
					24	V	V	V	V	V	V	V
					59.9	V	V	V	V	V	V	V
60					V	V	V	V	V	V	V	
Frame Sequential 3D	SVGA	800 x 600	1.33	4:3	120	V	V	V	V	V	V	V
	XGA	1024 x 768	1.33	4:3	120	V	V	V	V	V	V	V
	HDTV	1280 x 720	1.78	16:9	120	V	V	V	V	V	V	V
	HDTV	1280 x 800	1.78	16:9	120	V	V	V	V	V	V	V
	1080p	1920 x 1080	1.78	16:9	120	V	V	V	V	V	V	V
					60	V	V	V	V	V	V	V
					50	V	V	V	V	V	V	V
	WUXGA	1920 x 1200	1.6	16:10	120	V	V	V	V	V	V	V
60					V	V	V	V	V	V	V	
4K	3840 x 2160	3840 x 2160	1.78	16:9	24	V	V	V	V	V	V	V
					25	V	V	V	V	V	V	V
					30	V	V	V	V	V	V	V
					50	V	NA	NA	V	NA	NA	V
					60	V	NA	NA	V	NA	NA	V
	4096 x 2160 SMPTE	4096 x 2160	1.9	N/A	24	NA	NA	NA	NA	NA	NA	NA
					25	NA	NA	NA	NA	NA	NA	NA
					30	NA	NA	NA	NA	NA	NA	NA
					50	NA	NA	NA	NA	NA	NA	NA
					60	NA	NA	NA	NA	NA	NA	NA

Note:

- “V” means supported and “NA” means not supported.
- “RB” means “reduced blanking”.

ADDITIONAL INFORMATION

Signal Type	Signal Format	Resolution	Aspect Ratio		V Sync (Hz)	DisplayPort							
						RGB			YCbCr 4:4:4			YCbCr 4:2:2	
						8 bit	10 bit	12 bit	8 bit	10 bit	12 bit	8 bit	
PC	VGA	640 x 350	1.33	16:10	85	V	V	V	V	V	V	V	
		640 x 400			85	V	V	V	V	V	V	V	
		640 x 480	1.33	4:3	60	V	V	V	V	V	V	V	
					72	V	V	V	V	V	V	NA	
					75	V	V	V	V	V	V	V	
		720 x 400	1.8	9:5	85	V	V	V	V	V	V	NA	
					70	V	V	V	V	V	V	V	
		SVGA	800 x 600	1.33	4:3	85	V	V	V	V	V	V	V
	120					V	V	V	V	V	V	V	
	75					V	V	V	V	V	V	V	
	72					V	V	V	V	V	V	V	
	60					V	V	V	V	V	V	V	
	832 x 624		1.33	4:3	75	V	V	V	V	V	V	NA	
	848 x 480	60			V	V	V	V	V	V	V		
	XGA	1024 x 768	1.33	4:3	60	V	V	V	V	V	V	NA	
					70	V	V	V	V	V	V	NA	
					75	V	V	V	V	V	V	V	
					85	V	V	V	V	V	V	V	
	SXGA	1152 x 864	1.33	4:3	120	V	V	V	V	V	V		
		1152 x 870	1.32		75	V	V	V	V	V	V	NA	
	WXGA	1280 x 768	1.67	5:3	60	V	V	V	V	V	V	NA	
					75	V	V	V	V	V	V	V	
					85	V	V	V	V	V	V	NA	
	WXGA	1280 x 800	1.6	16:10	60	V	V	V	V	V	V	NA	
					75	V	V	V	V	V	V	V	
					85	V	V	V	V	V	V	V	
	SXGA	1280x960	1.33	4:3	60	V	V	V	V	V	V	V	
					85	V	V	V	V	V	V	V	
		1280 x 1024	1.25	5:4	60	V	V	V	V	V	V	V	
					75	V	V	V	V	V	V	V	
	WXGA	1360 x 765	1.78	16:9	85	V	V	V	V	V	V	V	
		1360 x 768			60	V	NA	NA	V	NA	NA	NA	
		1366 x 768			60	V	V	V	V	V	V	V	
	SXGA+	1400 x 1050	1.33	4:3	60	V	V	V	V	V	V	NA	
	WXGA+	1440 x 900	1.6	16:10	60	V	V	V	V	V	V	V	NA
					75	V	V	V	V	V	V	V	NA
					85	V	V	V	V	V	V	V	
	WXGA++	1600 x 900	1.78	16:9	60	V	V	V	V	V	V	V	
	UXGA	1600 x 1200	1.33	4:3	50	V	V	V	V	V	V	NA	
					60	V	V	V	V	V	V	NA	
WSXGA+	1680 x 1050	1.6	16:10	60	V	V	V	V	V	NA	NA		
WUXGA RB	1920 x 1200RB	1.6	16:10	50	V	V	V	V	V	V	NA	NA	
				60	V	V	V	V	V	V	V		

ADDITIONAL INFORMATION

Signal Type	Signal Format	Resolution	Aspect Ratio		V Sync (Hz)	DisplayPort							
						RGB			YCbCr 4:4:4			YCbCr 4:2:2	
						8 bit	10 bit	12 bit	8 bit	10 bit	12 bit	8 bit	
PC	2K	2560 x 1440RB	1.78	16:9	60	V	V	V	V	V	V	V	
TV	SDTV (480i)	720 x 480	1.5	3:2	59.94	V	V	V	V	V	V	NA	
	SDTV (480i)	720 x 480	1.5	3:2	60	V	V	V	V	V	V	NA	
	SDTV (576i)	720 x 576	1.25	5:4	50	V	V	V	V	V	V	NA	
	EDTV (480p)	720 x 480	1.5	3:2	59.94	V	V	V	V	V	V	V	
	EDTV (480p)	720 x 480	1.5	3:2	60	V	V	V	V	V	V	V	
	EDTV (576p)	720 x 576	1.25	5:4	50	V	V	V	V	V	V	V	
	HDTV (1080i)	1920 x 1080	1.78	16:9	50	V	V	V	V	V	V	V	NA
					59.94	V	V	V	V	V	V	V	NA
					60	V	V	V	V	V	V	V	V
	HDTV (720p)	1280 x 720	1.78	16:9	50	V	V	V	V	V	V	V	V
					59.94	V	V	V	V	V	V	V	V
					60	V	V	V	V	V	V	V	V
	HDTV (1080p)	1920 x 1080	1.78	16:9	23.98	V	V	V	V	V	V	V	V
					24	V	V	V	V	V	V	V	V
					25	V	V	V	V	V	V	V	V
					29.97	V	V	V	V	V	V	V	V
					30	V	V	V	V	V	V	V	V
					50	V	V	V	V	V	V	V	V
59.94					V	V	V	V	V	V	V	V	
60	V	V	V	V	V	V	V	V	V				
SD-SDI	SDTV (480i)	720 x 480	1.5	3:2	59.94	NA	NA	NA	NA	NA	NA	NA	
	SDTV (576i)	720 x 576	1.25	5:4	50	NA	NA	NA	NA	NA	NA	NA	
HD-SDI	HDTV (720p)	1280 x 720	1.78	16:9	50	NA	NA	NA	NA	NA	NA	NA	
					59.94	NA	NA	NA	NA	NA	NA	NA	
					60	NA	NA	NA	NA	NA	NA	NA	
	HDTV (1080i)	1920 x 1080	1.78	16:9	50	NA	NA	NA	NA	NA	NA	NA	
					59.94	NA	NA	NA	NA	NA	NA	NA	
					60	NA	NA	NA	NA	NA	NA	NA	
	HDTV (1080p)	1920 x 1080	1.78	16:9	23.98	NA	NA	NA	NA	NA	NA	NA	
					24	NA	NA	NA	NA	NA	NA	NA	
					25	NA	NA	NA	NA	NA	NA	NA	
					29.97	NA	NA	NA	NA	NA	NA	NA	
					30	NA	NA	NA	NA	NA	NA	NA	
	HDTV (1080sF)	1920 x 1080	1.78	16:9	25	NA	NA	NA	NA	NA	NA	NA	
					29.97	NA	NA	NA	NA	NA	NA	NA	
30					NA	NA	NA	NA	NA	NA	NA		
3GA-SDI	HDTV (1080p)	1920 x 1080	1.78	16:9	50	NA	NA	NA	NA	NA	NA	NA	
					59.94	NA	NA	NA	NA	NA	NA	NA	
					60	NA	NA	NA	NA	NA	NA	NA	
3GB-SDI	HDTV (1080p)	1920x1080 with 352M Payload ID	1.78	16:9	50	NA	NA	NA	NA	NA	NA	NA	
					59.94	NA	NA	NA	NA	NA	NA	NA	
					60	NA	NA	NA	NA	NA	NA	NA	

ADDITIONAL INFORMATION

Signal Type	Signal Format	Resolution	Aspect Ratio		V Sync (Hz)	DisplayPort						
						RGB			YCbCr 4:4:4			YCbCr 4:2:2
						8 bit	10 bit	12 bit	8 bit	10 bit	12 bit	8 bit
Mandatory 3D	Frame Packing (1080p)	1920 x 1080	1.78	16:9	23.98	NA	NA	NA	NA	NA	NA	NA
					24	NA	NA	NA	NA	NA	NA	NA
	Frame Packing (720p)	1280 x 720	1.78	16:9	50	NA	NA	NA	NA	NA	NA	NA
					59.94	NA	NA	NA	NA	NA	NA	NA
					60	NA	NA	NA	NA	NA	NA	NA
	Side by Side (1080i)	1920 x 1080	1.78	16:9	50	NA	NA	NA	NA	NA	NA	NA
					59.94	NA	NA	NA	NA	NA	NA	NA
					60	NA	NA	NA	NA	NA	NA	NA
	Side by Side (1080p)	1920 x 1080	1.78	16:9	24	NA	NA	NA	NA	NA	NA	NA
					50	NA	NA	NA	NA	NA	NA	NA
					59.9	NA	NA	NA	NA	NA	NA	NA
					60	NA	NA	NA	NA	NA	NA	NA
	Top and Bottom (720p)	1280 x 720	1.78	16:9	50	NA	NA	NA	NA	NA	NA	NA
					59.94	NA	NA	NA	NA	NA	NA	NA
					60	NA	NA	NA	NA	NA	NA	NA
	Top and Bottom (1080p)	1920 x 1080	1.78	16:9	23.98	NA	NA	NA	NA	NA	NA	NA
24					NA	NA	NA	NA	NA	NA	NA	
59.9					NA	NA	NA	NA	NA	NA	NA	
60					NA	NA	NA	NA	NA	NA	NA	
Frame Sequential 3D	SVGA	800 x 600	1.33	4:3	120	V	V	V	V	V	V	V
	XGA	1024 x 768	1.33	4:3	120	NA	NA	NA	NA	NA	NA	NA
	HDTV	1280 x 720	1.78	16:9	120	V	V	V	V	V	V	V
	HDTV	1280 x 800	1.78	16:9	120	V	V	V	V	V	V	V
	1080p	1920 x 1080	1.78	16:9	120	V	V	V	V	V	V	V
					60	V	V	V	V	V	V	V
					50	V	V	V	V	V	V	V
	WUXGA	1920 x 1200	1.6	16:10	120	V	V	V	V	V	V	V
60					V	V	V	V	V	V	V	
4K	3840 x 2160	3840 x 2160	1.78	16:9	24	V	V	V	V	V	V	V
					25	V	V	V	V	V	V	V
					30	V	V	V	V	V	V	V
					50	V	NA	NA	V	NA	V	V
					60	V	NA	NA	V	NA	NA	V
	4096 x 2160 SMPTE	4096 x 2160	1.9	N/A	24	V	V	V	V	V	V	V
					25	V	V	V	V	V	V	V
					30	V	V	V	V	V	V	V
					50	V	NA	NA	V	NA	NA	V
					60	V	NA	NA	V	NA	NA	V

Note:

- “V” means supported and “NA” means not supported.
- “RB” means “reduced blanking”.

ADDITIONAL INFORMATION

EDID table

VGA		
Established Timing:	Standard Timing:	Detail Timing:
720 x 400 @70Hz	1440 x 900 @75Hz	1920 x 1200 @59Hz
720 x 400 @88Hz	1280 x 800 @75Hz	1920 x 1080 @60Hz
640 x 480 @60Hz	1280 x 1024 @60Hz	
640 x 480 @67Hz	1360 x 765 @60Hz	
640 x 480 @72Hz	1440 x 900 @60Hz	
640 x 480 @75Hz	1400 x 1050 @60Hz	
800 x 600 @56Hz	1600 x 1200 @60Hz	
800 x 600 @60Hz	1680 x 1050 @60Hz	
800 x 600 @72Hz		
800 x 600 @75Hz		
832 x 624 @75Hz		
1024 x 768 @60Hz		
1024 x 768 @70Hz		
1024 x 768 @75Hz		
1280 x 1024 @75Hz		
1152 x 870 @75Hz		

DVI		
Established Timing:	Standard Timing:	Detail Timing:
720 x 400 @70Hz	1024 x 768 @120Hz	1920 x 1200 @59Hz
720 x 400 @88Hz	1280 x 800 @75Hz	1920 x 1080 @60Hz
640 x 480 @60Hz	1280 x 1024 @60Hz	640 x 480 @60Hz
640 x 480 @67Hz	1360 x 765 @60Hz	720 x 480 @60Hz
640 x 480 @72Hz	800 x 600 @120Hz	1280 x 720 @60Hz
640 x 480 @75Hz	1400 x 1050 @60Hz	1920 x 1080i @60Hz
800 x 600 @56Hz	1600 x 1200 @60Hz	720 x 480i @60Hz
800 x 600 @60Hz	1680 x 1050 @60Hz	720 x 576 @50Hz
800 x 600 @72Hz		1280 x 720 @50Hz
800 x 600 @75Hz		1920 x 1080i @50Hz
832 x 624 @75Hz		720 x 576i @50Hz
1024 x 768 @60Hz		1920 x 1080 @50Hz
1024 x 768 @70Hz		1920 x 1080 @24Hz
1024 x 768 @75Hz		1440 x 480 @60Hz
1280 x 1024 @75Hz		1920 x 1080 @25Hz
1152 x 870 @75Hz		

ADDITIONAL INFORMATION

HDMI 1.4		
Established Timing:	Standard Timing:	Detail Timing:
720 x 400 @70Hz	1024 x 768 @120Hz	1920 x 1200 @59Hz
720 x 400 @88Hz	1280 x 800 @75Hz	1920 x 1080 @60Hz
640 x 480 @60Hz	1280 x 1024 @60Hz	640 x 480 @60Hz
640 x 480 @67Hz	1360 x 765 @60Hz	720 x 480 @60Hz
640 x 480 @72Hz	800 x 600 @120Hz	1280 x 720 @60Hz
640 x 480 @75Hz	1400 x 1050 @60Hz	1920 x 1080i @60Hz
800 x 600 @56Hz	1600 x 1200 @60Hz	720 x 480i @60Hz
800 x 600 @60Hz	1680 x 1050 @60Hz	720 x 576 @50Hz
800 x 600 @72Hz		1280 x 720 @50Hz
800 x 600 @75Hz		1920 x 1080i @50Hz
832 x 624 @75Hz		720 x 576i @50Hz
1024 x 768 @60Hz		1920 x 1080 @50Hz
1024 x 768 @70Hz		1920 x 1080 @24Hz
1024 x 768 @75Hz		1440 x 480 @60Hz
1280 x 1024 @75Hz		1920 x 1080 @25Hz
1152 x 870 @75Hz		1280 x 720 @120Hz
		1920 x 1080 @120Hz
		3840 x 2160 @24Hz
		3840 x 2160 @25Hz
		3840 x 2160 @30Hz
		4096 x 2160 @24Hz
		4096 x 2160 @25Hz
		4096 x 2160 @30Hz

Note:

- “V” means supported and “NA” means not supported.
- “RB” means “reduced blanking”.

ADDITIONAL INFORMATION

HDMI 2.0		
Established Timing:	Standard Timing:	Detail Timing:
720 x 400 @70Hz	1024 x 768 @120Hz	1920 x 1200 @59Hz
720 x 400 @88Hz	1280 x 800 @75Hz	1920 x 1080 @60Hz
640 x 480 @60Hz	1280 x 1024 @60Hz	640 x 480 @60Hz
640 x 480 @67Hz	1360 x 765 @60Hz	720 x 480 @60Hz
640 x 480 @72Hz	800 x 600 @120Hz	1280 x 720 @60Hz
640 x 480 @75Hz	1400 x 1050 @60Hz	1920 x 1080i @60Hz
800 x 600 @56Hz	1600 x 1200 @60Hz	720 x 480i @60Hz
800 x 600 @60Hz	1680 x 1050 @60Hz	720 x 576 @50Hz
800 x 600 @72Hz		1280 x 720 @50Hz
800 x 600 @75Hz		1920 x 1080i @50Hz
832 x 624 @75Hz		720 x 576i @50Hz
1024 x 768 @60Hz		1920 x 1080 @50Hz
1024 x 768 @70Hz		1920 x 1080 @24Hz
1024 x 768 @75Hz		1440 x 480 @60Hz
1280 x 1024 @75Hz		1920 x 1080 @25Hz
1152 x 870 @75Hz		1280 x 720 @120Hz
		1920 x 1080 @120Hz
		3840 x 2160 @24Hz
		3840 x 2160 @25Hz
		3840 x 2160 @30Hz
		3840 x 2160 @50Hz
		3840 x 2160 @60Hz
		4096 x 2160 @24Hz
		4096 x 2160 @25Hz
		4096 x 2160 @30Hz
		4096 x 2160 @50Hz
		4096 x 2160 @60Hz

Note:

- “V” means supported and “NA” means not supported.
- “RB” means “reduced blanking”.

ADDITIONAL INFORMATION

Image size and projection distance

Platform			WUXGA (16:10)															
DMD			0.96"															
Projection Lens			A11		A18		A19		A20		A21		A22		A23		A27	
Throw Ratio Spec.(Wide/Tele)			0.65	0.75	0.84	1.02	1.02	1.36	1.2	1.5	1.50	2.00	2.00	4.00	4.00	7.20	7.2	10.8
Zoom Ratio			1.15x		1.2x		1.33x		1.25x		1.33x		2x		1.8x		1.5x	
Throw Distance (m) (min/max)			0.67	16.51	0.90	21.97	1.10	29.29	1.34	33.39	1.64	43.51	2.10	84.86	4.25	153.79	7.80	232.60
Projection screen size			Throw distance (m)															
Diagonal (inch)	Height (m)	Width (m)	Wide	Tele	Wide	Tele	Wide	Tele	Wide	Tele	Wide	Tele	Wide	Tele	Wide	Tele	Wide	Tele
50	0.67	1.08	0.67	0.78	0.90	1.10	1.10	1.46	1.34	1.67	1.64	2.18	2.10	4.24	4.25	7.69	7.80	11.69
60	0.81	1.29	0.81	0.94	1.09	1.32	1.32	1.76	1.60	2.00	1.96	2.61	2.52	5.09	5.10	9.23	9.35	14.02
70	0.94	1.51	0.95	1.11	1.27	1.54	1.54	2.05	1.87	2.34	2.29	3.05	2.94	5.94	5.96	10.77	10.89	16.34
80	1.08	1.72	1.10	1.27	1.45	1.76	1.76	2.34	2.14	2.67	2.62	3.48	3.36	6.79	6.81	12.30	12.44	18.67
90	1.21	1.94	1.24	1.44	1.63	1.98	1.98	2.64	2.40	3.00	2.95	3.92	3.78	7.64	7.66	13.84	13.98	20.99
100	1.35	2.15	1.38	1.61	1.81	2.20	2.20	2.93	2.67	3.34	3.27	4.35	4.20	8.49	8.51	15.38	15.53	23.32
110	1.48	2.37	1.53	1.77	1.99	2.42	2.42	3.22	2.94	3.67	3.60	4.79	4.62	9.34	9.36	16.92	17.08	25.65
120	1.62	2.58	1.67	1.94	2.17	2.64	2.64	3.52	3.21	4.01	3.93	5.22	5.04	10.18	10.21	18.45	18.62	27.97
130	1.75	2.80	1.81	2.10	2.35	2.86	2.86	3.81	3.47	4.34	4.26	5.66	5.46	11.03	11.06	19.99	20.17	30.30
140	1.88	3.02	1.96	2.27	2.53	3.08	3.08	4.10	3.74	4.67	4.58	6.09	5.88	11.88	11.91	21.53	21.72	32.62
150	2.02	3.23	2.10	2.43	2.71	3.30	3.30	4.39	4.01	5.01	4.91	6.53	6.30	12.73	12.76	23.07	23.26	34.95
160	2.15	3.45	2.24	2.60	2.89	3.52	3.52	4.69	4.27	5.34	5.24	6.96	6.72	13.58	13.61	24.61	24.81	37.27
170	2.29	3.66	2.39	2.77	3.08	3.73	3.73	4.98	4.54	5.68	5.57	7.40	7.14	14.43	14.46	26.14	26.36	39.60
180	2.42	3.88	2.53	2.93	3.26	3.95	3.95	5.27	4.81	6.01	5.89	7.83	7.56	15.28	15.31	27.68	27.90	41.92
190	2.56	4.09	2.67	3.10	3.44	4.17	4.17	5.57	5.07	6.34	6.22	8.27	7.98	16.12	16.17	29.22	29.45	44.25
200	2.69	4.31	2.82	3.26	3.62	4.39	4.39	5.86	5.34	6.68	6.55	8.70	8.40	16.97	17.02	30.76	31.00	46.57
250	3.37	5.38	3.53	4.09	4.52	5.49	5.49	7.32	6.68	8.35	8.18	10.88	10.50	21.22	21.27	38.45	38.73	58.20
300	4.04	6.46	4.25	4.92	5.43	6.59	6.59	8.79	8.01	10.02	9.82	13.05	12.60	25.46	25.52	46.14	46.46	69.83
350	4.71	7.54	4.97	5.75	6.33	7.69	7.69	10.25	9.35	11.68	11.46	15.23	14.70	29.70	29.78	53.83	54.19	81.45
400	5.38	8.62	5.68	6.58	7.24	8.79	8.79	11.72	10.68	13.35	13.10	17.40	16.80	33.95	34.03	61.52	61.93	93.08
450	6.06	9.69	6.40	7.40	8.14	9.89	9.89	13.18	12.02	15.02	14.73	19.58	18.90	38.19	38.29	69.21	69.66	104.71
500	6.73	10.77	7.12	8.23	9.05	10.98	10.98	14.65	13.35	16.69	16.37	21.75	21.00	42.43	42.54	76.89	77.39	116.33
550	7.40	11.85	7.84	9.06	9.95	12.08	12.08	16.11	14.69	18.36	18.01	23.93	23.10	46.68	46.79	84.58	85.12	127.96
600	8.08	12.92	8.55	9.89	10.86	13.18	13.18	17.58	16.03	20.03	19.64	26.11	25.20	50.92	51.05	92.27	92.86	139.59
650	8.75	14.00	9.27	10.72	11.76	14.28	14.28	19.04	17.36	21.70	21.28	28.28	27.30	55.16	55.30	99.96	100.59	151.21
700	9.42	15.08	9.99	11.54	12.67	15.38	15.38	20.51	18.70	23.37	22.92	30.46	29.40	59.40	59.56	107.65	108.32	162.84
750	10.10	16.15	10.70	12.37	13.57	16.48	16.48	21.97	20.03	25.04	24.55	32.63	31.50	63.65	63.81	115.34	116.05	174.47
800	10.77	17.23	11.42	13.20	14.47	17.58	17.58	23.43	21.37	26.71	26.19	34.81	33.60	67.89	68.06	123.03	123.79	186.10
850	11.44	18.31	12.14	14.03	15.38	18.67	18.67	24.90	22.70	28.38	27.83	36.98	35.70	72.13	72.32	130.72	131.52	197.72
900	12.12	19.39	12.85	14.86	16.28	19.77	19.77	26.36	24.04	30.05	29.47	39.16	37.80	76.38	76.57	138.41	139.25	209.35
950	12.79	20.46	13.57	15.69	17.19	20.87	20.87	27.83	25.37	31.72	31.10	41.33	39.90	80.62	80.83	146.10	146.98	220.98
1000	13.46	21.54	14.29	16.51	18.09	21.97	21.97	29.29	26.71	33.39	32.74	43.51	42.00	84.86	85.08	153.79	154.72	232.60

Note: If the screen is larger than 300 inches, then fine text and images may not display clearly.

ADDITIONAL INFORMATION

Projection distance

The distance between the projector and its screen determines the approximate size of the image. The farther the projector is from the screen, the larger the projected image will be. The image size also varies depending on the aspect ratio, zoom and other settings.

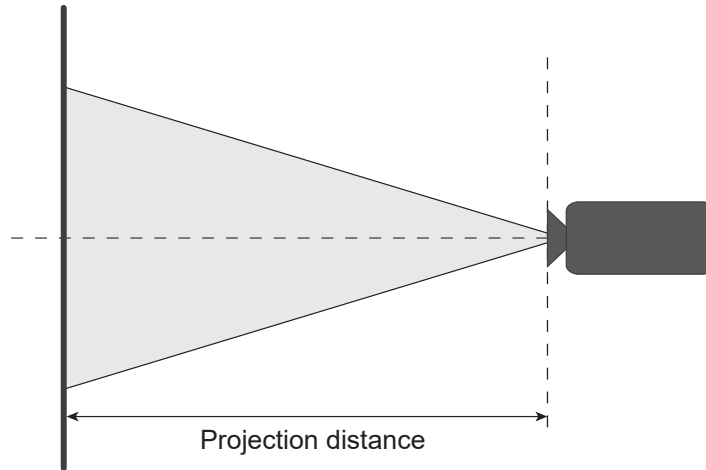

Powered lens shift range

Projection Lens	Optical Lens Shift Range		Mechanical Shift Range	
	ΔH_o	ΔV_o	Max. of ΔH_m	Max. of ΔV_m
A18, A19	11%	27%	50%	120%

V: Height of the projected image

H: Width of the projected image

□ Projected image

⚠ When the lens is shifted beyond the described range of operation, screen edges may become darker or images may become out of focus.

⚠ The lens cannot be shifted to this area by system control. (ΔH_{mc} : 23%, ΔV_{mc} : 0%)

Note: The calculation is based on 1/2 image width and 1/2 image height.

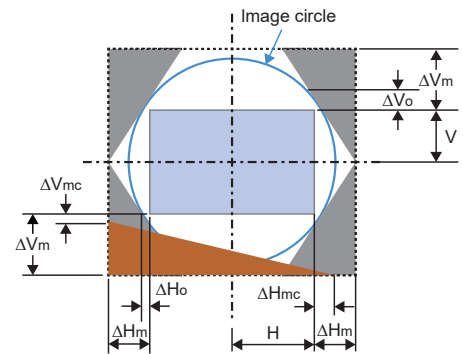

Projection Lens	Optical Lens Shift Range		Mechanical Shift Range	
	ΔH_o	ΔV_o	Max. of ΔH_m	Max. of ΔV_m
A11	48%	102%	50%	120%

V: Height of the projected image

H: Width of the projected image

□ Projected image

⚠ When the lens is shifted beyond the described range of operation, screen edges may become darker or images may become out of focus.

Note:

- The calculation is based on 1/2 image width and 1/2 image height.
- Lens shift accuracy is 0.5 pixel per step.

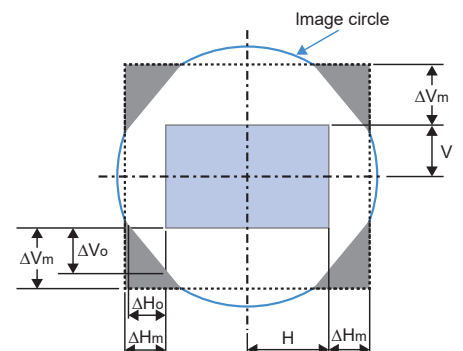

ADDITIONAL INFORMATION

Projection Lens	Optical Lens Shift Range		Mechanical Shift Range	
	ΔH_o	ΔV_o	Max. of ΔH_m	Max. of ΔV_m
A20, A21, A22, A23, A27	50%	120%	50%	120%

V: Height of the projected image

H: Width of the projected image

□ Projected image

⚠ When the lens is shifted beyond the described range of operation, screen edges may become darker or images may become out of focus.

Note: The calculation is based on 1/2 image width and 1/2 image height.

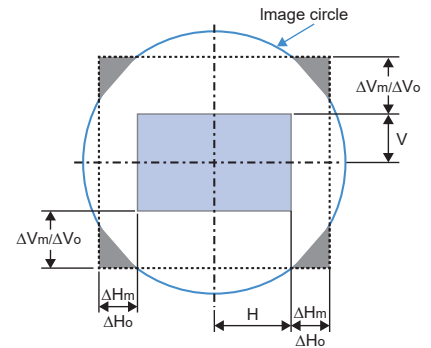

ADDITIONAL INFORMATION

Projector dimensions and ceiling mount installation

If you wish to use a third party ceiling mount kit, please ensure the screws used to attach a mount to the projector meet the following specifications:

- Screw type: M8*1.25P x4
- MIN. 10mm - MAX. 15mm

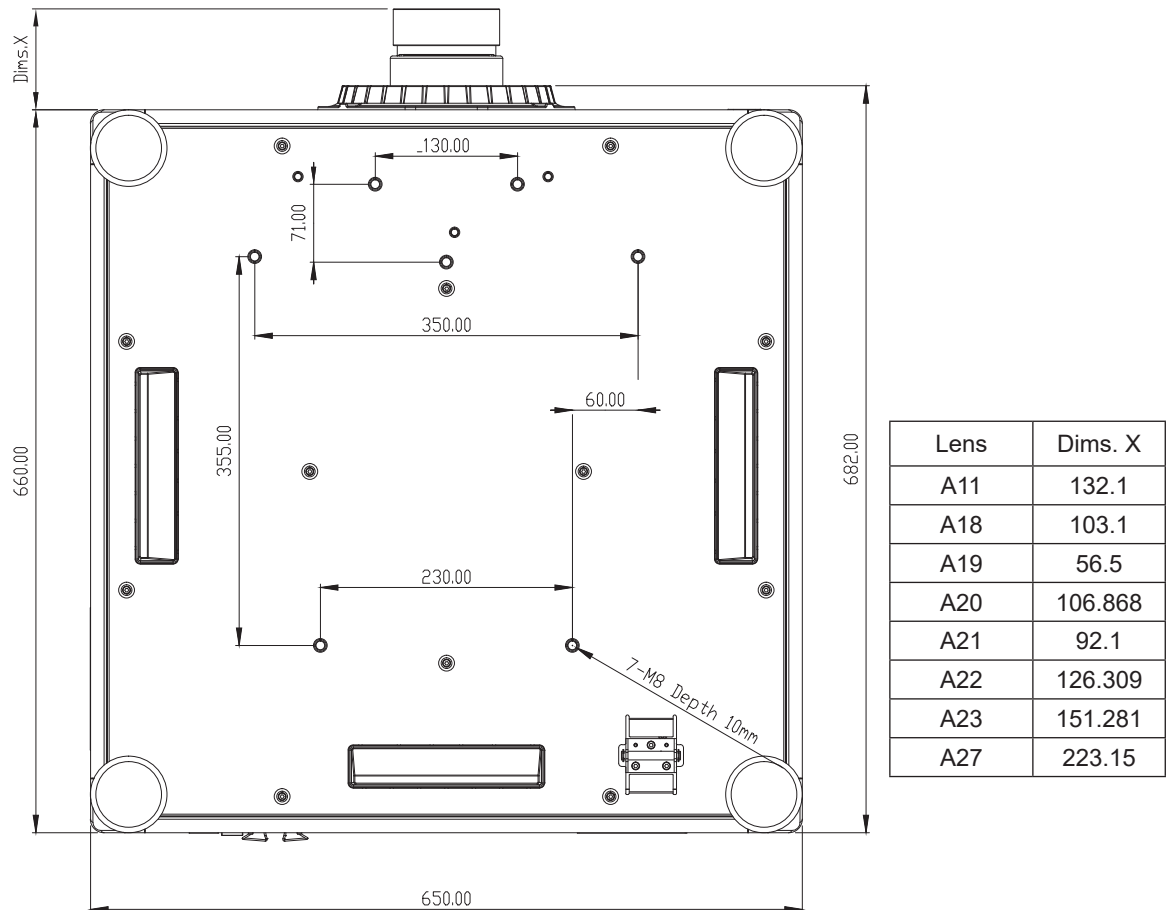

Dimensions given in millimeters



Warning:

- If you buy a ceiling mount from a third party, please be sure to use the correct screw size. Screw size will vary depending on the thickness of the mounting plate.
- Be sure to keep at least a 10mm (1cm) gap between the ceiling and the bottom of the projector.
- Avoid installing the projector near a heat source.
- Please note that damage resulting from incorrect installation will void the warranty.

ADDITIONAL INFORMATION

IR remote codes

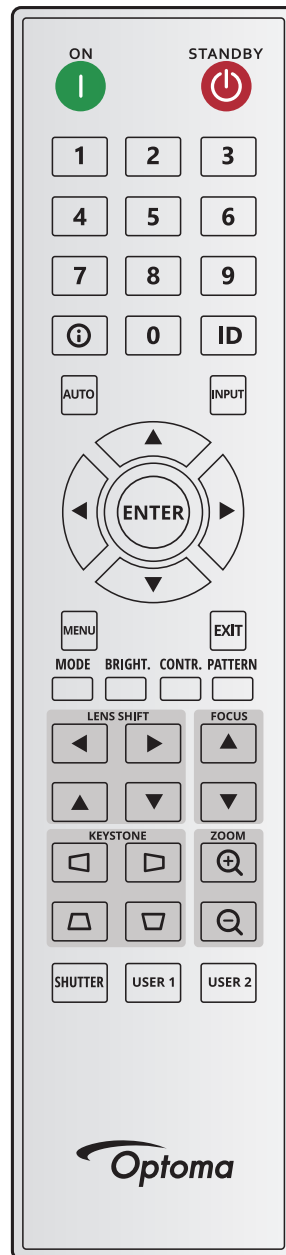

Key Legend	Key Position	Repeat Format	Address		Data		Description
			Byte 1	Byte 2	Byte 3	Byte 4	
ON (I)	1	F1	32	CD	2	FD	Press to turn on the projector.
OFF (⏻)	2	F1	32	CD	2E	D1	Press to turn off the projector.
1	3	F1	32	CD	72	8D	Use as numeric keypad number "1".
2	4	F1	32	CD	73	8C	Use as numeric keypad number "2".
3	5	F1	32	CD	74	8B	Use as numeric keypad number "3".
4	6	F1	32	CD	75	8A	Use as numeric keypad number "4".
5	7	F1	32	CD	77	88	Use as numeric keypad number "5".
6	8	F1	32	CD	78	87	Use as numeric keypad number "6".

ADDITIONAL INFORMATION

Key Legend	Key Position	Repeat Format	Address		Data		Description
			Byte 1	Byte 2	Byte 3	Byte 4	
7	9	F1	32	CD	79	86	Use as numeric keypad number "7".
8	10	F1	32	CD	80	7F	Use as numeric keypad number "8".
9	11	F1	32	CD	81	7E	Use as numeric keypad number "9".
Info (i)	12	F1	32	CD	82	7D	Press to display source image information.
0	13	F1	32	CD	25	DA	Use as numeric keypad number "0".
ID	14	F1	32	CD	A7	58	Press to set remote ID. Please refer to "Remote control ID setup" on page 26.
Auto	15	F1	32	CD	4	FB	Press to automatically synchronize the projector to the input source.
Input	16	F1	32	CD	18	E7	Press to select an input signal.
UP (▲)	17	F1	32	CD	0F	F0	Press to select items or make adjustments to our selection.
LEFT (◀)	18	F1	32	CD	11	EE	Press to select items or make adjustments to our selection.
Enter	19	F1	32	CD	14	EB	Press to confirm your item selection.
RIGHT (▶)	20	F1	32	CD	10	EF	Press to select items or make adjustments to our selection.
DOWN (▼)	21	F1	32	CD	12	ED	Press to select items or make adjustments to our selection.
Menu	22	F1	32	CD	0E	F1	Press to display the on-screen display menus for projector.
Exit	23	F1	32	CD	2A	D5	Press to return to previous level or exit menus if at top level.
Mode	24	F1	32	CD	5	FA	Press to select the preset display mode.
Bright.	25	F1	32	CD	28	D7	Press to adjust amount of light in the image.
Contr.	26	F1	32	CD	29	D6	Press to adjust difference between dark and light.
Pattern	27	F1	32	CD	58	A7	Press to display a test pattern.
Lens Shift ◀	28	F1	32	CD	41	BE	Press to adjust the position of the image horizontally.
Lens Shift ▶	29	F1	32	CD	42	BD	
Focus ▲	30	F1	32	CD	86	79	Press to adjust focus to improve image clarity as desired.
Lens Shift ▲	31	F1	32	CD	34	CB	Press to adjust the position of the image vertically.
Lens Shift ▼	32	F1	32	CD	32	CD	Press to adjust the position of the image vertically.
Focus ▼	33	F1	32	CD	26	D9	Press to adjust focus to improve image clarity as desired.
Keystone ◻	34	F1	32	CD	87	78	Press to adjust the horizontal keystone.
Keystone ◻	35	F1	32	CD	51	AE	Press to adjust the horizontal keystone.
Zoom ⊕	36	F1	32	CD	52	AD	Press to adjust zoom to achieve a desired image size.
Keystone ◻	37	F1	32	CD	53	AC	Press to adjust the vertical keystone.
Keystone ◻	38	F1	32	CD	54	AB	Press to adjust the vertical keystone.
Zoom ⊖	39	F1	32	CD	55	AA	Press to adjust zoom to achieve a desired image size.
Shutter (AV Mute)	40	F1	32	CD	56	A9	Press to hide/unhide the screen picture.
User 1	41	F1	32	CD	57	A8	Press to assign user functions. Please refer to "Remote Setup" on page 68.
User 2	42	F1	32	CD	27	D8	Press to assign user functions. Please refer to "Remote Setup" on page 68.

ADDITIONAL INFORMATION

Troubleshooting

If you experience a problem with your projector, please refer to the following information. If a problem persists, please contact your local reseller or service center.

Image problems

- ❓ *No image appears on-screen*
 - Ensure all the cables and power connections are correctly and securely connected as described in the *Setup and Installation* section.
 - Ensure the pins of connectors are not crooked or broken.
 - Ensure that the Shutter (AV Mute) feature is not turned on.
- ❓ *Image is out of focus*
 - Press the **Focus ▲** or **Focus ▼** button on the remote control or projector keypad to adjust the focus until the image is sharp and legible.
 - Make sure the projection screen is between the required distance from the projector. (Please refer to *Image size and projection distance* page 95).
- ❓ *The image is stretched when displaying 16:10 DVD title*
 - When you play anamorphic DVD or 16:10 DVD, the projector will show the best image in 16:10 format on projector side.
 - If you play 4:3 format DVD title, please change the format as 4:3 in projector OSD.
 - Please setup the display format as 16:10 (wide) aspect ratio type on your DVD player.
- ❓ *Image is too small or too large*
 - Press the **Zoom ⊕** or **Zoom ⊖** button on the remote control or projector keypad to adjust the projected image size.
 - Move the projector closer to or further from the screen.
 - From the OSD menu, select **Installation > Aspect Ratio** to change the aspect ratio.
- ❓ *Image has slanted sides:*
 - If possible, reposition the projector so that it is centered on the screen and below the bottom of the screen.
 - Press the **Keystone**  buttons on the remote control to adjust the screen shape.
- ❓ *Image is reversed*
 - From the OSD menu, select **Installation > Orientation > Direction > Rear Projection** to reverse the image so you can project from behind a translucent screen.

Other problems

- ❓ *The projector stops responding to all controls*
 - If possible, turn off the projector, then unplug the power cord and wait at least 20 seconds before reconnecting power.

Remote control problems

- ❓ *If the remote control does not work*
 - Check that the operating angle of the remote control is pointed within $\pm 30^\circ$ horizontally or $\pm 20^\circ$ vertically to the IR receivers on the projector.
 - Make sure there are not any obstructions between the remote control and the projector. Move to within 10 m (32.8 ft) of the projector.
 - Make sure batteries are inserted correctly.
 - Replace batteries if they are exhausted.

ADDITIONAL INFORMATION

LED status indicators

The LED status indicators are located on the rear of the projector. Each LED is defined below.

Message	Light			Status			AV Mute	
	Green	Orange	Red	Green	Orange	Red	Green	Orange
Standby State								
Power on (Warm up)					Flashing			
Power on & Laser diode on	Steady			Steady			Steady	
Power off (Cooling down)					Flashing			
AV mute is off (Image is displayed)	Steady			Steady			Steady	
AV mute is on (Image is black)	Steady			Steady				Steady
Projector communication/ operation	Steady			Flashing			Steady	
Firmware upgrade				Flashing	Flashing			
Burnin	Steady			Steady			Steady	
Factory Reset			Steady	Steady				
Error (Over temperature)						Steady		
Error (Fan failure)						Flashing		
Error (Color Wheel failure)						Flashing		

Note: Keypad LED (Power Key) will be in steady red for standby mode.

ADDITIONAL INFORMATION

Specifications

Optical	Description
Resolution	WUXGA (1920 x 1200)
Lens	Power Zoom/Focus and full lens shift
Image size (diagonal)	50"~500"
Projection distance	Please refer to "Throw Distance" spec. in "Image size and projection distance" on page 95.

Electrical	Description
Inputs	2 x HDMI In (version 2.0) (with locking screw) 1 x DisplayPort 1.2a 1 x DVI-D 1 x VGA In 1 x HDBaseT 1 x 3G-SDI In 1 x 3D SYNC In
Outputs	1 x HDMI Out (version 2.0) (with locking screw) 1 x 3G-SDI Out 1 x 3D SYNC Out
Control port	2 x RS232 (D-sub 9 pin) (PC Control) 2 x Wired in/out (3.5mm phone jack) (Remote In/out) 1 x 12V Trigger (3.5mm phone jack / Black) 1 x USB type A (5V/0.5A) 1 x RJ-45 (LAN) 2 x IR Receiver (Front / Top)
Power requirement	100-240V~, 50/60Hz, 16A 200-240V~, 50/60Hz, 8A

Mechanical	Description
Installation orientation	360° rotation, no restrictions
Dimensions	650 (W) x 682 (D) x 300.9 (H) mm (w/o lens, with feet) 650 (W) x 682 (D) x 251 (H) mm (w/o lens, w/o feet)
Environmental conditions	Operating: 0~50°C(32~122°F); 10~85%RH, non-condensing Storage: -10~60°C(14~140°F); 5~90%RH, non-condensing Note: If temperature is >40°C(104°F) or altitude >5000 ft, then the system will dim output brightness to ensure the normal operation of the projector.

Note: All specifications are subject to change without notice.

ADDITIONAL INFORMATION

RS232 protocol function list

Baud Rate : 115200 (default, depends on user setting)

Data Bits: 8

Parity: None

Stop Bits: 1

Flow Control : None

UART16550 FIFO: Disable

Write Command

~	X	X	X	X	X		n	CR
Lead Code	Projector ID		Command			space	variable	carriage return
Prefix	00~99 (Default: 00)		000~999				0~9999	suffix

Pass:

Fail:

Read Command

~	X	X	X	X	X		n	CR
Lead Code	Projector ID		Command			space	variable	carriage return
Prefix	00~99 (Default: 00)		000~999				0~9999	suffix

Response Format

Pass: Fail:

System Automatically Send

I	N	F	O	n
				Variable

Note: There is a <CR> after all ASCII commands 0D is the HEX code for <CR> in ASCII code.

ADDITIONAL INFORMATION

Character to HEX table

Character	HEX
~	7E
0	30
1	31
2	32
3	33
4	34
5	35
6	36
7	37
8	38
9	39
Space	20
CR (Enter)	0D

e.g.

ASCII to HEX

RS232 Command	~	0	0	1	9	5		1	CR
HEX	7E	30	30	31	39	35	20	31	0D

Main Menu: Image

Level 2	Level 3	Level 4	Level 5	Option / Value	Step	Write Command				Read Command									
						Command		Response		Command		Response							
						CMD	Set Para.	Fail	Pass	CMD	Value	Fail	Pass						
Picture Mode				[None]															
				Presentation		~XX20	1		F	P	~XX123	1	F	O	k	0			
				Bright		~XX20	2		F	P	~XX123	1	F	O	k	1			
				Super Bright (Depends on model)		~XX20	23		F	P	~XX123	1	F	O	k	2			
				Cinema		~XX20	3		F	P	~XX123	1	F	O	k	3			
				HDR		~XX20	21		F	P	~XX123	1	F	O	k	21			
				sRGB		~XX20	4		F	P	~XX123	1	F	O	k	4			
				DICOM SIM.		~XX20	13		F	P	~XX123	1	F	O	k	10			
				Blending		~XX20	19		F	P	~XX123	1	F	O	k	19			
				3D		~XX20	9		F	P	~XX123	1	F	O	k	9			
				2D High Speed		~XX20	18		F	P	~XX123	1	F	O	k	18			
				User		~XX20	6,26,30~37		F	P	~XX123	1	F	O	k	6,26,30~37			
	Dynamic Range	HDR			Off		~XX565	0		F	P								
					Auto		~XX565	1		F	P								
		HDR Picture Mode			Bright		~XX566	0		F	P								
				Standard		~XX566	1		F	P									
				Film		~XX566	2		F	P									
				Detail		~XX566	3		F	P									
Brightness			0-100	1	~XX21	0~100		F	P	~XX125	1	F	O	k	0~100				
Contrast			0-100	1	~XX22	0~100		F	P	~XX126	1	F	O	k	0~100				
Sharpness			1-15	1	~XX23	1~15		F	P										
Gamma				Film		~XX35	1		F	P									
				Graphics		~XX35	3		F	P									
				Standard(2.2)		~XX35	4		F	P									
				Vivid		~XX35	21		F	P									
				3D		~XX35	9		F	P									
				Blackboard		~XX35	10		F	P									
				DICOM SIM.		~XX35	11		F	P									
				1.8		~XX35	5		F	P									
				2		~XX35	6		F	P									
				2.4		~XX35	12		F	P									
				2.6		~XX35	8		F	P									
	Dynamic Contrast	Dynamic Black			Off		~XX191	0		F	P								
				On		~XX191	1		F	P									
Speed				1-15	1	~XX253	1~15		F	P									
Strength				0-3	1	~XX254	0~3		F	P									
Level				50%-100%	1%	~XX255	50~100		F	P									
Extreme Black				Off		~XX218	0		F	P									
				On		~XX218	1		F	P									
AV Mute Timer				0.0s-10.0s	0.5s	~XX256	0~20		F	P									
Black Signal Level			0-5	1	~XX257	0~5		F	P										
Color Settings	Color			0-100	1	~XX45	0~100		F	P									
				0-100	1	~XX44	0~100		F	P									
	Tint			Warm		~XX36	4		F	P	~XX128	1	F	O	k	3			
				Standard		~XX36	1		F	P	~XX128	1	F	O	k	0			
				Cool		~XX36	2		F	P	~XX128	1	F	O	k	1			
	White Balance	Red Gain			0-100	1	~XX24	0~100		F	P								
					0-100	1	~XX25	0~100		F	P								
		Green Gain			0-100	1	~XX26	0~100		F	P								
		Blue Gain			0-100	1	~XX27	0~100		F	P								
		Red Offset			0-100	1	~XX27	0~100		F	P								
Green Offset			0-100	1	~XX28	0~100		F	P										

ADDITIONAL INFORMATION

Level 2	Level 3	Level 4	Level 5	Option / Value	Step	Write Command				Read Command							
						Command		Response		Command		Response					
						CMD	space	Set	Para.	Fail	Pass	CMD	space	CMD	Value	Fail	Pass
		Blue Offset		0-100	1	~XX29		0~100		F	P						
	White Enhancement			0-10	1	~XX34		0~10		F	P						
	Color Space			Auto		~XX37		1		F	P						
				RGB (0-255)		~XX37		2		F	P						
				RGB (16-235)		~XX37		4		F	P						
				REC709		~XX37		5		F	P						
				REC601		~XX37		6		F	P						
	Color Matching	Auto Test Pattern		Off		~XX411		0		F	P						
				On		~XX411		1		F	P						
	Red			Hue	0-254	1	~XX327		0-254		F	P					
				Saturation	0-254	1	~XX333		0-254		F	P					
				Luminance	0-254	1	~XX339		0-254		F	P					
	Green			Hue	0-254	1	~XX328		0-254		F	P					
				Saturation	0-254	1	~XX334		0-254		F	P					
				Luminance	0-254	1	~XX340		0-254		F	P					
	Blue			Hue	0-254	1	~XX329		0-254		F	P					
				Saturation	0-254	1	~XX335		0-254		F	P					
				Luminance	0-254	1	~XX341		0-254		F	P					
	Cyan			Hue	0-254	1	~XX330		0-254		F	P					
				Saturation	0-254	1	~XX336		0-254		F	P					
				Gain	0-254	1	~XX342		0-254		F	P					
	Magenta			Hue	0-254	1	~XX332		0-254		F	P					
				Saturation	0-254	1	~XX338		0-254		F	P					
				Luminance	0-254	1	~XX344		0-254		F	P					
	Yellow			Hue	0-254	1	~XX331		0-254		F	P					
				Saturation	0-254	1	~XX337		0-254		F	P					
				Luminance	0-254	1	~XX343		0-254		F	P					
	White			Red	0-254	1	~XX345		0-254		F	P					
				Green	0-254	1	~XX346		0-254		F	P					
				Blue	0-254	1	~XX347		0-254		F	P					
	Reset					~XX215		1		F	P						
Wall Color				Off		~XX506		0		F	P						
				Blackboard		~XX506		1		F	P						
				Light Yellow		~XX506		7		F	P						
				Light Green		~XX506		3		F	P						
				Light Blue		~XX506		4		F	P						
				Pink		~XX506		5		F	P						
				Gray		~XX506		6		F	P						
				Off		~XX230		4		F	P						
3D Setup	3D Mode			Active 3D		~XX230		0		F	P						
				Passive 3D		~XX230		5		F	P						
	3D Format			Auto		~XX405		0		F	P						
				Frame Packing		~XX405		7		F	P						
				Side by Side		~XX405		1		F	P						
				Top and Bottom		~XX405		2		F	P						
				Frame Sequential		~XX405		3		F	P						
	3D Tech			DLP-link		~XX230		1		F	P						
				3D Sync		~XX230		3		F	P						
	3D-2D			3D		~XX400		0		F	P						
			L		~XX400		1		F	P							
			R		~XX400		2		F	P							

Level 2	Level 3	Level 4	Level 5	Option / Value	Step	Write Command				Read Command						
						Command		Response		Command		Response				
						CMD	space	Set	Para.	Fail	Pass	CMD	space	CMD	Value	Fail
	3D Sync Out			To Emitter		~XX232		0		F	P					
			To Next Projector		~XX232		1		F	P						
	3D Invert			Off		~XX231		0		F	P					
				On		~XX231		1		F	P					
	Frame Delay			1-200	1	~XX233		1~500		F	P					
	Reset					~XX234		1		F	P					
Save to User				User-Presentation		~XX424		31		F	P					
				User-Bright		~XX424		32		F	P					
				User-Super Bright (Depends on model)		~XX424		30		F	P					
				User-Cinema		~XX424		33		F	P					
				User-HDR		~XX424		26		F	P					
				User-sRGB		~XX424		34		F	P					
				User-DICOM SIM.		~XX424		35		F	P					
				User-Blending		~XX424		36		F	P					
				User-3D		~XX424		6		F	P					
				User-2D High Speed		~XX424		37		F	P					
Apply to User				User-Presentation		~XX20		31		F	P	~XX123	1	F	O	k 31
				User-Bright		~XX20		32		F	P	~XX123	1	F	O	k 32
				User-Super Bright (Depends on model)		~XX20		30		F	P	~XX123	1	F	O	k 30
				User-Cinema		~XX20		33		F	P	~XX123	1	F	O	k 33
				User-HDR		~XX20		26		F	P	~XX123	1	F	O	k 26
				User-sRGB		~XX20		34		F	P	~XX123	1	F	O	k 34
				User-DICOM SIM.		~XX20		35		F	P	~XX123	1	F	O	k 35
				User-Blending		~XX20		36		F	P	~XX123	1	F	O	k 36
				User-3D		~XX20		6		F	P	~XX123	1	F	O	k 6
				User-2D High Speed		~XX20		37		F	P	~XX123	1	F	O	k 37
Reset					~XX509		1		F	P						

Note: Some commands are not supported, it depends on models.

ADDITIONAL INFORMATION

Main Menu: Display

Level 2	Level 3	Level 4	Level 5	Level 6	Option / Value	Step	Write Command					Read Command										
							Command			Response		Command		Response								
							CMD	space	Set Para	Fail	Pass	CMD	space	CMD Value	Fail	Pass						
Aspect Ratio					Auto		~XX60		7		F	P	~XX127		1		F	O	k	7		
					4:3		~XX60		1		F	P	~XX127		1		F	O	k	1		
					16:9		~XX60		2		F	P	~XX127		1		F	O	k	2		
					16:10		~XX60		3		F	P	~XX127		1		F	O	k	3		
					LBX		~XX60		5		F	P	~XX127		1		F	O	k	5		
					Native		~XX60		6		F	P	~XX127		1		F	O	k	6		
Digital Zoom	Proportional				Off		~XX364		0		F	P										
					On		~XX364		1		F	P										
	Horizontal				50%-400%		1	~XX504		50~400		F	P									
					Vertical		50%-400%		1	~XX505		50~400		F	P							
	Horizontal Shift				0-100		1	~XX365		0~100		F	P									
	Vertical Shift				0-100		1	~XX366		0~100		F	P									
	Reset							~XX364		9		F	P									
Image Shift	H. Position				0-100		1	~XX63		0~100		F	P									
	V. Position				0-100		1	~XX64		0~100		F	P									
	Reset							~XX172		1		F	P									
Geometric Correction	Warp Control				Basic			~XX142		1		F	P									
					Advanced			~XX142		5		F	P									
					AP				~XX142		2		F	P								
	Basic Warp	Keystone	Horizontal			0-40		1	~XX65		0~40		F	P	~XX543		4		F	O	k	0~40
						Vertical		0-40		1	~XX66		0~40		F	P	~XX543		3		F	O
		Pincushion	Horizontal			0-100		1	~XX300		0~100		F	P	~XX543		6		F	O	k	0~100
						Vertical		0-100		1	~XX301		0~100		F	P	~XX543		5		F	O
		4-Corner	Top Left (icon)			right +1		1	~XX59		1		F	P								
						left +1			~XX59		2		F	P								
						up +1			~XX59		3		F	P								
						down +1			~XX59		4		F	P								
			Top Right (icon)			right +1		1	~XX59		5		F	P								
						left +1			~XX59		6		F	P								
						up +1			~XX59		7		F	P								
						down +1			~XX59		8		F	P								
		Bottom Left (icon)			right +1		1	~XX59		9		F	P									
					left +1			~XX59		10		F	P									
					up +1			~XX59		11		F	P									
					down +1			~XX59		12		F	P									
	Bottom Right (icon)			right +1		1	~XX59		13		F	P										
				left +1			~XX59		14		F	P										
				up +1			~XX59		15		F	P										
				down +1			~XX59		16		F	P										
	Advanced Warp	Grid Color				Green			~XX143		1		F	P								
						Magenta			~XX143		2		F	P								
						Red			~XX143		3		F	P								
						Cyan			~XX143		4		F	P								
		Grid Background				Black			~XX145		1		F	P								
						Transparent			~XX145		2		F	P								
Warp Setting		Grid Points				2x2			~XX144		1		F	P								
						3x3			~XX144		2		F	P								
						5x5			~XX144		3		F	P								
						9x9			~XX144		4		F	P								
						17x17			~XX144		5		F	P								
		Warp Inner				Off			~XX146		0		F	P								
						On			~XX146		1		F	P								
Warp Sharpness					0 ~ 9		1	~XX148		0~9		F	P									
Blend Setting					Blend Width		4															

Note: Some commands are not supported, it depends on models.

ADDITIONAL INFORMATION

Level 2	Level 3	Level 4	Level 5	Level 6	Option / Value	Step	Write Command					Read Command							
							Command			Response		Command		Response					
							CMD	space	Set Para	Fail	Pass	CMD	space	CMD Value	Fail	Pass			
			Overlap Grid Number		4		~XX169	1		F	P								
					6		~XX169	2		F	P								
					8		~XX169	3		F	P								
					10		~XX169	4		F	P								
					12		~XX169	5		F	P								
			Gamma		1.8		~XX170	1		F	P								
					1.9		~XX170	2		F	P								
					2		~XX170	3		F	P								
					2.1		~XX170	4		F	P								
					2.2		~XX170	5		F	P								
					2.3		~XX170	6		F	P								
					2.4		~XX170	7		F	P								
		Black Level	Area		Bottom														
					Top														
			Enable		Off		~XX166	4/6		F	P								
					On		~XX166	3/5		F	P								
			Edit Area																
			Add Point																
			Remove Point																
			Brightness	Brightness		RGB + 1	~XX263	1/2/3/4		F	P								
				Red	0-255	1	~XX281~XX2 nnn			F	P			~XX272~XX 1	F	O	k	nnn	
				Green	0-255	1	~XX282~XX2 nnn			F	P			~XX272~XX 2	F	O	k	nnn	
				Blue	0-255	1	~XX283~XX2 nnn			F	P			~XX272~XX 3	F	O	k	nnn	
			Exit																
			Red		0-255														
			Green		0-255														
			Blue		0-255														
			Reset	Bottom			~XX167	3		F	P								
				Top			~XX167	5		F	P								
				All			~XX167	1		F	P								
	Memory	Save Memory			Memory 1 - Memory 5		~XX141	1~5		F	P								
		Apply Memory			Memory 1 - Memory 5		~XX147	1~5		F	P			~XX137	1	F	O	k	1~5
		Clear Memory																	
	Reset						~XX174	1		F	P								
Edge Mask					0-10	1	~XX561	1		F	P								
Freeze Screen					Unfreeze		~XX61	0~10		F	P								
					Freeze		~XX04	0		F	P								
							~XX04	1		F	P								

Note: Some commands are not supported, it depends on models.

ADDITIONAL INFORMATION

Level 2	Level 3	Level 4	Level 5	Level 6	Option / Value	Step	Write Command					Read Command								
							Command			Response		Command		Response						
							CMD	space	Set Para	Fail	Pass	CMD	space	CMD Value	Fail	Pass				
Test Pattern					Off		~XX195	0		F	P									
					Green Grid		~XX195	3		F	P									
					Magenta Grid		~XX195	4		F	P									
					White Grid		~XX195	1		F	P									
					White		~XX195	2		F	P									
					Black		~XX195	11		F	P									
					Red		~XX195	5		F	P									
					Green		~XX195	6		F	P									
					Blue		~XX195	7		F	P									
					Yellow		~XX195	8		F	P									
					Magenta		~XX195	9		F	P									
					Cyan		~XX195	10		F	P									
					ANSI Contrast 4x4		~XX195	14		F	P									
					Color bar		~XX195	13		F	P									
					Full screen		~XX195	15		F	P									
	PIP/PBP	Screen				Off		~XX302	0		F	P								
					PIP		~XX302	1		F	P									
					PBP		~XX302	2		F	P									
Main Source					[no Signal]															
					VGA		~XX12	5		F	P									
					HDMI1		~XX12	1		F	P									
					HDMI2		~XX12	15		F	P									
					DVI-D		~XX12	2		F	P									
					Display Port		~XX12	20		F	P									
					3G-SDI		~XX12	22		F	P									
					HDBaseT		~XX12	21		F	P									
		Sub Source				[no Signal]														
					VGA		~XX305	2		F	P									
					HDMI1		~XX305	1		F	P									
					HDMI2		~XX305	4		F	P									
					DVI-D		~XX305	9		F	P									
					Display Port		~XX305	17		F	P									
					3G-SDI		~XX305	11		F	P									
					HDBaseT		~XX305	10		F	P									
							~XX306	1		F	P									
Swap Size					Small		~XX304	3		F	P									
					Medium		~XX304	2		F	P									
					Large		~XX304	1		F	P									
Location					PBP, Main Left		~XX303	5		F	P									
					PBP, Main Top		~XX303	6		F	P									
					PBP, Main Right		~XX303	7		F	P									
					PBP, Main Bottom		~XX303	8		F	P									
					PIP, Bottom Right		~XX303	4		F	P									
					PIP, Bottom Left		~XX303	3		F	P									
					PIP, Top Left		~XX303	1		F	P									
				PIP, Top Right		~XX303	2		F	P										
						~XX173	1		F	P										
Reset																				

Note: Some commands are not supported, it depends on models.

ADDITIONAL INFORMATION

Main Menu:Input Settings

Level 2	Level 3	Level 4	Option / Value	Step	Write Command					Read Command							
					Command			Response		Command		Response					
					CMD	spat	Set Para	Fail	Pass	CMD	spat	CMD Value	Fail	Pass			
Auto Source			Off		~XX563	0		F	P								
			On		~XX563	1		F	P								
Active Inputs			VGA		~XX408	5		F	P								
			HDMI1		~XX408	1		F	P								
			HDMI2		~XX408	15		F	P								
			DVI-D		~XX408	2		F	P								
			Display Port		~XX408	20		F	P								
			3G-SDI		~XX408	22		F	P								
			HDBaseT		~XX408	21		F	P								
Latency Adjustment			Normal		~XX220	0		F	P	~XX133	1		F	O	k 0		
			2D Ultra		~XX220	1		F	P	~XX133	1		F	O	k 1		
Backup Input	Auto Switch		Off		~XX264	0		F	P	~XX274	1		F	O	k 0		
			On		~XX264	1		F	P	~XX274	1		F	O	k 1		
			(read only)														
	Current Signal	First Input		HDMI1		~XX265	7		F	P	~XX275	1		F	O	k 7	
				HDMI2		~XX265	8		F	P	~XX275	1		F	O	k 8	
				HDBaseT		~XX265	16		F	P	~XX275	1		F	O	k 16	
				Display Port		~XX265	15		F	P	~XX275	1		F	O	k 15	
	Second Input			HDMI1		~XX266	7		F	P	~XX276	1		F	O	k 7	
				HDMI2		~XX266	8		F	P	~XX276	1		F	O	k 8	
				HDBaseT		~XX266	16		F	P	~XX276	1		F	O	k 16	
				Display Port		~XX266	15		F	P	~XX276	1		F	O	k 15	
	Backup Input Status		Active/Inactive (read only)							~XX277	1		F	O	k 0=Inactive 1=Active		
	Backup Input Change		Changed/No Change (read only)							~XX278	1		F	O	k 0=No Change 1=Changed		
	Backup Input Info.	Current Signal		(read only)							~XX279	1		F	O	k a=0 None a=1 DVI a=2 VGA a=7 HDMI1 a=8 HDMI2 a=15 Display Port a=16 HDBaseT a=18 3G-SDI	
			Backup Input Status	Active/Inactive (read only)							~XX277	1		F	O	k 0=Inactive 1=Active	
			Backup Input Change	Changed/No Change (read only)							~XX278	1		F	O	k 0=No Change 1=Changed	
			First Input	By First Input (read only)							~XX275	1		F	O	k a=7 HDMI1 a=8 HDMI2 a=16 HDBaseT a=15 Display Port	
			Resolution	(read only)													
			Horz Refresh	(read only)													
			Color Space	(read only)													

Level 2	Level 3	Level 4	Option / Value	Step	Write Command					Read Command					
					Command			Response		Command		Response			
					CMD	spat	Set Para	Fail	Pass	CMD	spat	CMD Value	Fail	Pass	
		HDR	Yes/No (read only)												
		Second Input	By Second Input (read only)							~XX276	1		F	O	k a=7 HDMI1 a=8 HDMI2 a=16 HDBaseT a=15 Display Port
		Resolution	(read only)												
		Horz Refresh	(read only)												
		Color Space	(read only)												
		HDR	Yes/No (read only)												
VGA	Phase		0-100	1	~XX74	0	~100	F	P						
	Resolution		(read only)												
HDMI	Output		HDMI 1		~XX309	5		F	P						
			HDMI 2		~XX309	6		F	P						
			1.4		~XX236	1		F	P						
			2		~XX236	2		F	P						
			1.4		~XX237	1		F	P						
HDBaseT	EDID		2		~XX237	2		F	P						
			1.4		~XX238	1		F	P						
			2		~XX238	2		F	P						
Reset					~XX178	1		F	P						

Note: Some commands are not supported, it depends on models.

ADDITIONAL INFORMATION

Level 2	Level 3	Level 4	Level 5	Option / Value	Step	Write Command				Read Command				
						Command			Response		Command		Response	
						CMD	space	Set Para.	Fail	Pass	CMD	space	Set Para.	Fail
Wednesday / Thursday / Friday / Saturday / Sunday	Event 01-16	Time	Function	00:00 ~ 23:59	~XX471	dhhmmnaabb	F	P						
				Off	~XX471	dhhmmnaabb	F	P						
				Power Settings	~XX471	dhhmmnaabb	F	P						
				Input Source	~XX471	dhhmmnaabb	F	P						
				Light Source Mode	~XX471	dhhmmnaabb	F	P						
				Shutter	~XX471	dhhmmnaabb	F	P						
				Event	Off	~XX471	dhhmmnaabb	F					P	
				(Function = Power Settings)	Power On	~XX471	dhhmmnaabb	F					P	
				Eco	~XX471	dhhmmnaabb	F	P						
				Active	~XX471	dhhmmnaabb	F	P						
				Communication	~XX471	dhhmmnaabb	F	P						
				(Function = Input Source)	VGA	~XX471	dhhmmnaabb	F					P	
				HDMI1	~XX471	dhhmmnaabb	F	P						
				HDMI2	~XX471	dhhmmnaabb	F	P						
				DVI-D	~XX471	dhhmmnaabb	F	P						
				Display Port	~XX471	dhhmmnaabb	F	P						
				3G-SDI	~XX471	dhhmmnaabb	F	P						
				HDBaseT	~XX471	dhhmmnaabb	F	P						
				(Function = Light Source Mode)	Normal Mode	~XX471	dhhmmnaabb	F					P	
				Eco Mode	~XX471	dhhmmnaabb	F	P						
				Custom Brightness	~XX471	dhhmmnaabb	F	P						
				(Function = Shutter)	Shutter On	~XX471	dhhmmnaabb	F					P	
				Shutter Off	~XX471	dhhmmnaabb	F	P						
				Reset	n ~nn	~XX472	n ~nn	F					P	
				Copy Events To	Monday	~XX473	1 ~n	F					P	
					Tuesday	~XX473	2 ~n	F					P	
					Wednesday	~XX473	3 ~n	F					P	
					Thursday	~XX473	4 ~n	F					P	
					Friday	~XX473	5 ~n	F					P	
					Saturday	~XX473	6 ~n	F					P	
					Sunday	~XX473	7 ~n	F					P	
				Reset the Day	~XX471	9 ~n	F	P						
				Reset Schedule	~XX284	9	F	P						
				Date and Time	Clock Mode	Use NTP Server	~XX474	1					F	P
						Manual	~XX474	3					F	P
					Date	2000 ~ 2037 (Year)	~XX475	n n n n					F	P
						01 ~ 12 (Month)	~XX476	n n					F	P
					Time	01 ~ 31 (Day)	~XX477	n n					F	P
						00 ~ 23 (Hour)	~XX478	n n					F	P
					Daylight Saving Time	00 ~ 59 (Minute)	~XX479	n n					F	P
Off	~XX480	0	F			P								
On	~XX480	1	F		P									
NTP Server	time.google.com	~XX481	1		F	P								
	asia.pool.ntp.org	~XX481	2		F	P								
	europa.pool.ntp.org	~XX481	3		F	P								
	north-america.pool.ntp.org	~XX481	4		F	P								
Time Zone	UTC+14:00	~XX482	1		F	P								
	UTC+13:00	~XX482	2		F	P								
	UTC+12:45	~XX482	3		F	P								
	UTC+12:00	~XX482	4		F	P								
	UTC+11:00	~XX482	5		F	P								
	UTC+10:30	~XX482	6		F	P								
	UTC+10:00	~XX482	7		F	P								
	UTC+09:30	~XX482	8	F	P									
	UTC+09:00	~XX482	9	F	P									
	UTC+08:45	~XX482	10	F	P									
	UTC+08:00	~XX482	11	F	P									

Note: Some commands are not supported, it depends on models.

ADDITIONAL INFORMATION

Level 2	Level 3	Level 4	Level 5	Option / Value	Step	Write Command				Read Command		
						Command			Response	Command		Response
						CMD	Set	Para.	Fail	Pass	CMD	Response
				UTC+07:00		~XX482	12		F	P		
				UTC+06:30		~XX482	13		F	P		
				UTC+06:00		~XX482	14		F	P		
				UTC+05:45		~XX482	15		F	P		
				UTC+05:30		~XX482	16		F	P		
				UTC+05:00		~XX482	17		F	P		
				UTC+04:30		~XX482	18		F	P		
				UTC+04:00		~XX482	19		F	P		
				UTC+03:30		~XX482	20		F	P		
				UTC+03:00		~XX482	21		F	P		
				UTC+02:00		~XX482	22		F	P		
				UTC+01:00		~XX482	23		F	P		
				UTC+00:00		~XX482	24		F	P		
				UTC-01:00		~XX482	25		F	P		
				UTC-02:00		~XX482	26		F	P		
				UTC-03:00		~XX482	27		F	P		
				UTC-03:30		~XX482	28		F	P		
				UTC-04:00		~XX482	29		F	P		
				UTC-05:00		~XX482	30		F	P		
				UTC-06:00		~XX482	31		F	P		
				UTC-07:00		~XX482	32		F	P		
				UTC-08:00		~XX482	33		F	P		
				UTC-09:00		~XX482	34		F	P		
				UTC-09:30		~XX482	35		F	P		
				UTC-10:00		~XX482	36		F	P		
				UTC-11:00		~XX482	37		F	P		
				UTC-12:00		~XX482	38		F	P		
		Update Interval		Hourly		~XX483	1		F	P		
				Daily		~XX483	3		F	P		
		Apply				~XX484	1		F	P		
Power Settings	Power Mode (Standby)			Eco		~XX114	0		F	P		
				Active		~XX114	1		F	P		
				Communication		~XX114	3		F	P		
	Signal Power On			Off		~XX113	0		F	P		
				On		~XX113	1		F	P		
	Auto Power Off			0-180 m	5m	~XX106	0~180		F	P		
	Sleep Timer			0-16 h	0.5h	~XX107	0~16		F	P		
12V Trigger			Off		~XX192	0		F	P			
			On		~XX192	1		F	P			
Light Source Settings	Reset			Normal		~XX110	1		F	P		
				Eco Mode		~XX110	2		F	P		
				Custom Power		~XX110	9		F	P		
	Custom Brightness	Brightness Level		30%-100%	1%	~XX326	30~100		F	P		
		Constant Brightness		Off		~XX522	0		F	P		
			On		~XX522	1		F	P			
Shutter	Fade-In			0.5 -5s	0.5s	~XX267	1~10		F	P		
				0.5 -5s	0.5s	~XX268	1~10		F	P		
	Startup			Shutter Off		~XX269	0		F	P		
				Shutter On		~XX269	1		F	P		
Security	Security			Off		~XX78	0~nnnn		F	P		
				On		~XX78	1~nnnn		F	P		
				Security Timer	Month	0-35	~XX537	00~35		F	P	
			Day	0-29	~XX538	00~29		F	P			
			Hour	0-23	~XX539	00~23		F	P			
						~XX77	MMDDHH		F	P		
			Change Password			~XX406	nnnn~nnnn		F	P		
On Screen Display	Menu Location			Top Left		~XX72	1		F	P		
				Top Right		~XX72	2		F	P		

Level 2	Level 3	Level 4	Level 5	Option / Value	Step	Write Command				Read Command			
						Command			Response	Command		Response	
						CMD	Set	Para.	Fail	Pass	CMD	Response	
				Center		~XX72	3		F	P			
				Bottom Left		~XX72	4		F	P			
				Bottom Right		~XX72	5		F	P			
	Menu Transparency			0-9		~XX526	0~9		F	P			
		Menu Timer		Off		~XX515	0		F	P			
				5s		~XX515	1		F	P			
				10s		~XX515	3		F	P			
				15s		~XX515	4		F	P			
			30s		~XX515	5		F	P				
				60s		~XX515	6		F	P			
	Information Hide			Off		~XX102	0		F	P			
		Background		On		~XX102	1		F	P			
				Blue		~XX104	1		F	P			
			Black		~XX104	0		F	P				
				White		~XX104	5		F	P			
Logo Setup	Change Logo			Logo		~XX104	7		F	P			
				Default Logo		~XX82	1		F	P			
				Neutral		~XX82	3		F	P			
		Logo Capture			User Logo		~XX82	4		F	P		
				Captured Logo		~XX82	2		F	P			
	Delete Logo			Captured Logo		~XX83	1		F	P			
Backlight	Keypad			Off		~XX407	1		F	P			
				On		~XX407	2		F	P			
	Power Key			Off		~XX362	0		F	P			
				On		~XX362	1		F	P			
High Altitude				Off		~XX362	3		F	P			
				On		~XX362	4		F	P			
				Off		~XX101	0		F	P			
User Data	Save All Settings			Memory 1 - Memory 5		~XX258	1~5		F	P			
				Memory 1 - Memory 5		~XX259	1~5		F	P			
System Update (FOTA)	Auto			Off		~XX168	0		F	P			
				On		~XX168	1		F	P			
	Auto Download			Off		~XX168	3		F	P			
				On		~XX168	4		F	P			
	Update			On		~XX168	9		F	P			
Reset	Reset OSD			Off		~XX546	1		F	P			
				On		~XX546	2		F	P			
	Reset to Default			Image		~XX112	1		F	P			
				Display		~XX509	1		F	P			
	Reset Selective			Input		~XX173	1		F	P			
				Communication		~XX178	1		F	P			
			Setup		~XX176	1		F	P				
					~XX179	1		F	P				

Note: Some commands are not supported, it depends on models.

ADDITIONAL INFORMATION

Main Menu: Communication

Level 2	Level 3	Level 4	Option / Value	Step	Write Command				Read Command			
					Command		Response		Command		Response	
					CMD	Set Para.	Fail	Pass	CMD	Set Para.	Fail	Pass
Projector ID			0-99		~XX79	00~99	F	P	~XX558	1	F	O k 00~99
Remote Setup	Remote Code		0-99		~XX350	00~99	F	P	~XX138	1	F	O k 0~9
		Quick Switch Code	Off		~XX314	0	F	P	~XX138	3	F	O k 0
	1~9			~XX314	0~9	F	P	~XX138	3	F	O k 0~9	
	IR Function	Front	Off		~XX11	4	F	P	~XX542	1	F	O k 0
			On		~XX11	5	F	P	~XX542	1	F	O k 1
		Top	Off		~XX11	6	F	P	~XX542	2	F	O k 0
			On		~XX11	7	F	P	~XX542	2	F	O k 1
		HDBaseT	Off		~XX11	10	F	P	~XX542	3	F	O k 0
			On		~XX11	9	F	P	~XX542	3	F	O k 1
	User 1		Freeze Screen		~XX117	1	F	P				
			Blank Screen		~XX117	2	F	P				
			PIP/PBP		~XX117	3	F	P				
			Aspect Ratio		~XX117	4	F	P				
			Information Hide		~XX117	5	F	P				
			Network setup		~XX117	6	F	P				
			Projector ID		~XX117	7	F	P				
			Color Matching		~XX117	8	F	P				
			Reset Selective		~XX117	9	F	P				
			User 2		Freeze Screen		~XX118	1	F	P		
	Blank Screen				~XX118	2	F	P				
	PIP/PBP				~XX118	3	F	P				
	Aspect Ratio				~XX118	4	F	P				
	Information Hide				~XX118	5	F	P				
	Network setup				~XX118	6	F	P				
	Projector ID				~XX118	7	F	P				
	Color Matching				~XX118	8	F	P				
	Reset Selective				~XX118	9	F	P				
Network Setup	LAN Interface	RJ-45				~XX460	1	F	P			
		HDBaseT		~XX460	2	F	P					
	MAC Address		(read only)					~XX555	1	F	O k nn:nn:nn:nn:nn	
	Network Status		(read only) Connected					~XX87	1	F	O k 1	
			(read only) Disconnected					~XX87	1	F	O k 0	
	DHCP	Off		~XX461	0	F	P	~XX150	17	F	O k 0	
		On		~XX461	1	F	P	~XX150	17	F	O k 1	
	IP Address		---:---:---:---:---				~XX87	3	F	O k nn:nn:nn:nn:nn		
	Subnet Mask		---:---:---:---:---									
	Gateway		---:---:---:---:---									
DNS		---:---:---:---:---										
Apply				~XX462	9	F	P					
Network Reset				~XX462	1	F	P					
Email Notification	Email 1											
	Email 2		Email 1 Address (read only)					~XX443	1	F	O k n@nnnn.nnnn.nnnn	

Note: Some commands are not supported, it depends on models.

ADDITIONAL INFORMATION

Level 2	Level 3	Level 4	Option / Value	Step	Write Command				Read Command											
					Command		Response		Command		Response									
					CMD	space Set Para.	Fail	Pass	CMD	space CMD Value	Fail	Pass								
			Email 1 Address (read only)																	
			Event																	
			Fan Error		~XX463	2/1		F	P											
			Power On/Off		~XX463	4/3		F	P											
			Video Loss		~XX463	6/5		F	P											
			Laser		~XX463	8/7		F	P											
			Reset		~XX464	1		F	P											
Control	Crestron		Off		~XX454	0		F	P											
			On		~XX454	1		F	P											
			IP Address		~XX465	1 ~nnn.nnn.nnn.nnn		F	P											
			IPID		~XX466	1 ~nnn		F	P											
			Port		~XX467	1 ~nnnnn		F	P											
			Crestron Setup Apply		~XX454	9		F	P											
			PJ Link		~XX456	0		F	P											
			Off		~XX456	1		F	P											
			On		~XX468	0		F	P											
			Authentication		~XX468	1		F	P											
			Off		~XX470	nn...n (20 characters)		F	P											
			On		~XX469	1 ~nnn.nnn.nnn.nnn		F	P											
			Password	(read only)	~XX456	9		F	P											
			Service		~XX455	0		F	P											
			PJ Link Setup Apply		~XX455	1		F	P											
			Extron		~XX457	0		F	P											
			Off		~XX457	1		F	P											
			On		~XX458	0		F	P											
			AMX		~XX458	1		F	P											
			Off		~XX459	0		F	P											
			On		~XX459	1		F	P											
			Telnet		~XX459	1		F	P											
			Off		~XX181	1		F	P											
			On																	
Baud Rate	Serial Port In		1200																	
			2400																	
			4800																	
			9600																	
			19200																	
			38400																	
			57600																	
			115200																	
	Serial Port Out		1200																	
			2400																	
			4800																	
			9600																	
			19200																	
			38400																	
			57600																	
			115200																	
Reset					~XX176	1		F	P											

Main Menu: Information

Level 2	Level 3	Level 4	Level 5	Option / Value	Step	Write Command				Read Command										
						Command		Response		Command		Response								
						CMD	space Set Para.	Fail	Pass	CMD	space CMD Value	Fail	Pass							
Device	Regulatory																			
	Serial Number																			
	Projection Hours																			
System Status	Standby Mode																			
	Light Source Mode																			
	Light Source Hours																			
	Total Hours																			
	Normal																			
	Eco Mode																			
	Custom Power																			
	Temperature																			
	AC Voltage																			
Communication	Projector ID					~XX79	00~99	F	P											
	Remote Code					~XX350	00~99	F	P											
Firmware Version	Main Version																			

Note: Some commands are not supported, it depends on models.

ADDITIONAL INFORMATION

Other RS232

Level 1	Level 2	Level 3	Write Command				Read Command			
			Command			Response	Command			Response
			CMD	space	Set Para.	Fail	CMD	space	CMD Value	Fail
Other Items										
Power Off			~XX00	0		F	~XX124	1	F	O k 0
Power On			~XX00	1		F	~XX124	1	F	O k 1
Re-Sync			~XX01	1		F				
AV Mute	Off		~XX02	0		F	~XX355	1	F	O k 0
	On		~XX02	1		F	~XX355	1	F	O k 1
Freeze	Unfreeze		~XX04	0		F				
	Freeze		~XX04	1		F				
3D Sync Out	To Emitter		~XX232	0		F				
	To Next Projector		~XX232	1		F				
3D Frame Delay	1~200		~XX233	1~nnn		F				
Output 3D state	2D						~XX130	1	F	O k 0
	3D						~XX130	1	F	O k 1
System Auto Send	Standby Mode									I N F O 0
	Warming up									I N F O 1
	Cooling Down									I N F O 2
	Out of Range									I N F O 3
	lightsource Fail (LED Fail)									I N F O 4
	Thermal Switch Error									I N F O 5
	Fan Lock									I N F O 6
	Over Temperature									I N F O 7
	LightSource Hours Running Out									I N F O 8
	Cover Open									I N F O 9
	lightsource Ignite Fail									I N F O 10
	Format Board Power On Fail									I N F O 11
	Color Wheel Unexpected Stop									I N F O 12
	Over Temperature									I N F O 13
	FAN 1 Lock									I N F O 14
	FAN 2 Lock									I N F O 15
	FAN 3 Lock									I N F O 16
	FAN 4 Lock									I N F O 17
	FAN 5 Lock									I N F O 18
	LAN fail then restart									I N F O 19
	LD lower than 60%									I N F O 20
	LD NTC (1) Over Temperature									I N F O 21
	LD NTC (2) Over Temperature									I N F O 22
	High Ambient Temperature									I N F O 23
	System Ready									I N F O 24
										I N F O 25
	FAN 6 Lock									I N F O 26
	FAN 7 Lock									I N F O 27
	FAN 8 Lock									I N F O 28
	FAN 9 Lock									I N F O 29
	FAN 10 Lock									I N F O 30
	FAN 11 Lock									I N F O 31
	FAN 12 Lock									I N F O 32
	FAN 13 Lock									I N F O 33
	FAN 14 Lock									I N F O 34
System Temperature Level	Green/Normal						~XX155	1	F	O k 1
	Orange/Notice						~XX155	1	F	O k 2
	Red/Warning. About to trigger shutdown						~XX155	1	F	O k 3
Fan Status Level	Green/Normal						~XX159	1	F	O k 1
	Orange/Notice						~XX159	1	F	O k 2

Note: Some commands are not supported, it depends on models.

ADDITIONAL INFORMATION

Level 1	Level 2	Level 3	Write Command			Read Command								
			Command		Response	Command		Response						
			CMD	space Set Para.		CMD	space CMD Value	Fail	Pass					
	Red/Warning. About to trigger shutdown													
Device Type	Projector					~XX159	1		F	O	k	3		
Model Name	Optoma SVGA					~XX149	1		F	O	k	1		
	Optoma XGA					~XX151	1		F	O	k	1		
	Optoma WXGA					~XX151	1		F	O	k	2		
	Optoma 1080P					~XX151	1		F	O	k	3		
	Optoma WUXGA					~XX151	1		F	O	k	4		
	Optoma UHD					~XX151	1		F	O	k	5		
Camera Status						~XX151	1		F	O	k	6		
						~XX221	1		F	O	k	a=0 Camera disconnect a=1 Camera supported		
OSD Lock	On		~XX239	1 ~nnnnnnnn	F	~XX229	1		F	O	k	1		
	Off		~XX239	2 ~nnnnnnnn	F	~XX229	1		F	O	k	0		
Regulatory Model						~XX151	3		F	O	k			
RS232 Version No						~XX152	1		F	O	k	nnnnnn (RS232 Version No)		
Software Version						~XX122	1		F	O	k	nnnnnn (Software Version)		
LAN FW version						~XX357	1		F	O	k	nnnnnn (LAN FW version)		
Fan Speed	Fan 1 Speed	0000~9999				~XX351	1		F	O	k	0000~9999		
	Fan 2 Speed	0000~9999				~XX351	2		F	O	k	0000~9999		
	Fan 3 Speed	0000~9999				~XX351	3		F	O	k	0000~9999		
	Fan 4 Speed	0000~9999				~XX351	4		F	O	k	0000~9999		
	Fan 5 Speed	0000~9999				~XX351	5		F	O	k	0000~9999		
	Fan 6 Speed	0000~9999				~XX351	6		F	O	k	0000~9999		
	Fan 7 Speed	0000~9999				~XX351	7		F	O	k	0000~9999		
	Fan 8 Speed	0000~9999				~XX351	8		F	O	k	0000~9999		
	Fan 9 Speed	0000~9999				~XX351	9		F	O	k	0000~9999		
	Fan 10 Speed	0000~9999				~XX351	10		F	O	k	0000~9999		
	Fan 11 Speed	0000~9999				~XX351	11		F	O	k	0000~9999		
	Fan 12 Speed	0000~9999				~XX351	12		F	O	k	0000~9999		
	Fan 13 Speed	0000~9999				~XX351	13		F	O	k	0000~9999		
	Fan 14 Speed	0000~9999				~XX351	10		F	O	k	0000~9999		
System Temperature						~XX352	1		F	O	k	0000~9999		
Information	Info String					~XX150	1		F	O	k	abbbbcddddd (Note*1)		
	Native Resolution					~XX150	2		F	O	k	nnn..nn (e.g. Ok1920x1080)		
	Main Source					~XX150	3		F	O	k	nnn..nn (e.g. OkHDMI)		
	- Resolution					~XX150	4		F	O	k	nnn..nn (e.g. Ok1920x1080)		
	- Signal Format					~XX150	5		F	O	k	nnn..nn		
	- Pixel Clock					~XX150	6		F	O	k	nnn..nn		
	- Horz Refresh					~XX150	7		F	O	k	nnn..nn		
	- Vert Refresh					~XX150	8		F	O	k	nnn..nn		
	Sub Source					~XX150	9		F	O	k	nnn..nn		
	- Resolution					~XX150	10		F	O	k	nnn..nn (e.g. Ok1920x1080)		
	- Signal Format					~XX150	11		F	O	k	nnn..nn (e.g. OkHDMI)		
	- Pixel Clock					~XX150	12		F	O	k	nnn..nn		
	- Horz Refresh					~XX150	13		F	O	k	nnn..nn		
	- Vert Refresh					~XX150	14		F	O	k	nnn..nn		
	Light Source Mode					~XX150	15		F	O	k	nnn..nn		
	Standby Power Mode	Active				~XX150	16		F	O	k	1		
		Eco.				~XX150	16		F	O	k	0		
		Communication				~XX150	16		F	O	k	3		
	DHCP	Off				~XX150	17		F	O	k	0		
		On				~XX150	17		F	O	k	1		
	System Temperature					~XX150	18		F	O	k	nnn..nn (e.g. Ok48)		
	Refresh rate					~XX150	19		F	O	k	nnn..nn (e.g. Ok60Hz)		
Source Lock	On		~XX100	0	F									
	Off		~XX100	1	F									
Display message on the OSD			~XX210	nn...n (50 characters)	F									
Filter Wheel Index			~XX528	0000~9999	F									
						~XX530	1		F	O	k	0000~9999		

Note: Some commands are not supported, it depends on models.

ADDITIONAL INFORMATION

Level 1	Level 2	Level 3	Write Command			Read Command		
			Command		Response	Command		Response
			CMD	space Set Para.	Fail	CMD	space CMD Value	Fail Pass
Phosphor Wheel Index			~XX529	0000~9999	F	~XX531	1	F O k 0000~9999
Remote Control Simulation								
Power			~XX140	1	F			
Power Off			~XX140	2	F			
Up			~XX140	10	F			
Left			~XX140	11	F			
Enter (for projection MENU)			~XX140	12	F			
Right			~XX140	13	F			
Down			~XX140	14	F			
V Keystone +			~XX140	15	F			
V Keystone -			~XX140	16	F			
Brightness			~XX140	19	F			
Menu			~XX140	20	F			
DVI-D			~XX140	22	F			
VGA-1			~XX140	23	F			
AV Mute			~XX140	24	F			
Contrast			~XX140	28	F			
Zoom +			~XX140	32	F			
Zoom -			~XX140	33	F			
Focus +			~XX140	34	F			
Focus -			~XX140	35	F			
Mode			~XX140	36	F			
info			~XX140	40	F			
Re-sync			~XX140	41	F			
HDMI 1			~XX140	42	F			
HDMI 2			~XX140	43	F			
Source			~XX140	47	F			
1			~XX140	51	F			
2			~XX140	52	F			
3			~XX140	53	F			
4			~XX140	54	F			
5			~XX140	55	F			
6			~XX140	56	F			
7			~XX140	57	F			
8			~XX140	58	F			
9			~XX140	59	F			
0			~XX140	60	F			
Gamma			~XX140	61	F			
PIP			~XX140	63	F			
Lens H(left)			~XX140	64	F			
Lens H(Right)			~XX140	65	F			
Lens V(left)			~XX140	66	F			
Lens V(Right)			~XX140	67	F			
H Keystone +			~XX140	68	F			
H Keystone -			~XX140	69	F			
Hot Key (user1)(F1)			~XX140	70	F			
Hot Key (user2)(F2)			~XX140	71	F			
Pattern			~XX140	73	F			
Exit			~XX140	74	F			
Display Port			~XX140	76	F			
Mute			~XX140	77	F			
Return			~XX140	82	F			



Note: Some commands are not supported, it depends on models.

Optoma global offices

For service or support, please contact your local office.



USA

Optoma Technology, Inc.
47697 Westinghouse Drive.
Fremont, Ca 94539

 888-289-6786
 510-897-8601
 services@optoma.com



Canada

Optoma Technology, Inc.
47697 Westinghouse Drive.
Fremont, Ca 94539

 888-289-6786
 510-897-8601
 services@optoma.com



Latin America

Optoma Technology, Inc.
47697 Westinghouse Drive.
Fremont, Ca 94539

 888-289-6786
 510-897-8601
 services@optoma.com



Europe

Unit 1, Network 41, Bourne End Mills
Hemel Hempstead, Herts,
HP1 2UJ, United Kingdom
www.optoma.eu
Service Tel : +44 (0)1923 691865

 +44 (0) 1923 691 800
 +44 (0) 1923 691 888
 service@tsc-europe.com



Benelux BV

Randstad 22-123
1316 BW Almere
The Netherlands
www.optoma.nl

 +31 (0) 36 820 0252
 +31 (0) 36 548 9052



France

Bâtiment E
81-83 avenue Edouard Vaillant
92100 Boulogne Billancourt, France

 +33 1 41 46 12 20
 +33 1 41 46 94 35
 savoptoma@optoma.fr



Spain

C/ José Hierro,36 Of. 1C
28522 Rivas VaciaMadrid,
Spain

 +34 91 499 06 06
 +34 91 670 08 32



Deutschland

Am Nordpark 3
41069 Mönchengladbach
Germany

 +49 (0) 2161 68643 0
 +49 (0) 2161 68643 99
 info@optoma.de

Scandinavia



Lerpeveien 25
3040 Drammen
Norway

 +47 32 98 89 90
 +47 32 98 89 99
 info@optoma.no

PO.BOX 9515
3038 Drammen
Norway

Korea

WOOMI TECH.CO.,LTD.
4F, Minu Bldg.33-14, Kangnam-Ku,
Seoul,135-815, KOREA
korea.optoma.com

 +82+2+34430004
 +82+2+34430005



Japan

東京都足立区綾瀬 3-25-18
株式会社オーエス
コンタクトセンター: 0120-380-495

 info@os-worldwide.com
www.os-worldwide.com



Taiwan

12F., No.213, Sec. 3, Beixin Rd.,
Xindian Dist., New Taipei City 231,
Taiwan, R.O.C.
www.optoma.com.tw

 +886-2-8911-8600
 +886-2-8911-6550
 services@optoma.com.tw
asia.optoma.com



Hong Kong

Unit A, 27/F Dragon Centre,
79 Wing Hong Street,
Cheung Sha Wan,
Kowloon, Hong Kong

 +852-2396-8968
 +852-2370-1222
www.optoma.com.hk

China

5F, No. 1205, Kaixuan Rd.,
Changning District
Shanghai, 200052, China

 +86-21-62947376
 +86-21-62947375
www.optoma.com.cn

