



Table of Contents

Table of Contents	1	DISPLAY 3D	42
Usage Notice	2	SETUP	43
Safety Information	2	SETUP Audio Settings	45
Precautions	3	SETUP Security	46
Eye Safety Warnings	5	SETUP Network LAN Settings	48
Product Features	5	SETUP Network Control Settings ...	50
Introduction	6	SETUP Advanced	51
Package Overview	6	OPTIONS	52
Product Overview	7	OPTIONS Lamp Settings	55
Main Unit	7	OPTIONS Remote Settings	57
Keypad	8	OPTIONS Advanced	58
Input/Output Connections	9	OPTIONS Optional Filter Settings ..	59
Remote Control	10	Appendices	60
Installation	11	Troubleshooting	60
Connecting to the Projector	11	Image Problems	60
Connecting a Computer/Notebook ...	11	Other Problems	62
Connecting a Video source	12	Remote Control Problems	62
Connect to 3D Video Devices	13	LED Lighting Messages	63
Using the 3D glasses	15	On Screen Messages	64
Powering On/Off the Projector	16	Replacing the Lamp	65
Powering On the Projector	16	Installing and Cleaning	
Powering Off the Projector	17	the Dust Filter	67
Warning Indicator	18	Compatibility Modes	68
Adjusting the Projected Image	19	RS232 Commands and Protocol	
Adjusting the Projector's Height	19	Function List	70
Adjusting the Projector's Zoom /		RS232 Pin Assignments	70
Focus	20	RS232 Protocol Function List	71
Adjusting Projection Image Size	20	Ceiling Mount Installation	75
User Controls	22	Optoma Global Offices	76
Keypad & Remote Control	22	Regulation & Safety Notices	78
Keypad	22	FCC Notice	78
Remote Control	23	Declaration of Conformity	
On-screen Display Menus	30	for EU countries	79
How to operate	30		
Menu Tree	31		
IMAGE	34		
IMAGE Advanced	36		
IMAGE Advanced Signal (RGB) ...	38		
DISPLAY	39		

Safety Information

	The lightning flash with arrow head within an equilateral triangle is intended to alert the user to the presence of uninsulated "dangerous voltage" within the product's enclosure that may be of sufficient magnitude to constitute a risk of electric shock to persons.
	The exclamation point within an equilateral triangle is intended to alert the user to the presence of important operating and maintenance (servicing) instructions in the literature accompanying the appliance.

WARNING: TO REDUCE THE RISK OF FIRE OR ELECTRIC SHOCK, DO NOT EXPOSE THIS APPLIANCE TO RAIN OR MOISTURE. DANGEROUS HIGH VOLTAGES ARE PRESENT INSIDE THE ENCLOSURE. DO NOT OPEN THE CABINET. REFER SERVICING TO QUALIFIED PERSONNEL ONLY.

Class B emissions limits

This Class B digital apparatus meets all requirements of the Canadian Interference-Causing Equipment Regulations.

Important Safety Instruction

1. Do not block any ventilation openings. To ensure reliable operation of the projector and to protect from over heating, it is recommended to install the projector in a location that does not block ventilation. As an example, do not place the projector on a crowded coffee table, sofa, bed, etc. Do not put the projector in an enclosure such as a book case or a cabinet that restricts air flow.
2. Do not use the projector near water or moisture. To reduce the risk of fire and/or electric shock, do not expose the projector to rain or moisture.
3. Do not install near heat sources such as radiators, heaters, stoves or any other apparatus such as amplifiers that emits heat.
4. Clean only with dry cloth.
5. Only use attachments/accessories specified by the manufacturer.
6. Do not use the unit if it has been physically damaged or abused. Physical damage/abuse would be (but not limited to):
 - Unit has been dropped.
 - Power supply cord or plug has been damaged.
 - Liquid has been spilled on to the projector.
 - Projector has been exposed to rain or moisture.
 - Something has fallen in the projector or something is loose inside.Do not attempt to service the unit yourself. Opening or removing covers may expose you to dangerous voltages or other hazards. Please call Optoma before you send the unit for repair.
7. Do not let objects or liquids enter the projector. They may touch dangerous voltage points and short out parts that could result in fire or electric shock.
8. See projector enclosure for safety related markings.
9. The unit should only be repaired by appropriate service personnel.

Precautions



Please follow all warnings, precautions and maintenance as recommended in this user's guide.



❖ When the lamp reaches the end of its life, the projector will not turn back on until the lamp module has been replaced. To replace the lamp, follow the procedures listed under "Replacing the Lamp" section on pages 65-66.

- | | |
|----------|---|
| Warning- | Do not look into the projector's lens when the lamp is on. The bright light may hurt your eyes. |
| Warning- | To reduce the risk of fire or electric shock, do not expose this projector to rain or moisture. |
| Warning- | Please do not open or disassemble the projector as this may cause electric shock. |
| Warning- | When replacing the lamp, please allow the unit to cool down. Follow instructions as described on pages 65-66. |
| Warning- | This projector will detect the life of the lamp itself. Please be sure to change the lamp when it shows warning messages. |
| Warning- | Reset the "Lamp Reset" function from the on-screen display "Options Lamp Settings" menu after replacing the lamp module (refer to page 55). |
| Warning- | When switching the projector off, please ensure the cooling cycle has been completed before disconnecting power. Allow 90 seconds for the projector to cool down. |
| Warning- | Do not use lens cap when projector is in operation. |
| Warning- | When the lamp is approaching to the end of its life time, the message "Lamp life exceeded." will show on the screen. Please contact your local reseller or service center to change the lamp as soon as possible. |

Usage Notice

Do:

- ❖ Turn off and unplug the power plug from the AC outlet before cleaning the product.
- ❖ Use a soft dry cloth with mild detergent to clean the display housing.
- ❖ Disconnect the power plug from AC outlet if the product is not being used for a long period of time.

Do not:

- ❖ Block the slots and openings on the unit provided for ventilation.
- ❖ Use abrasive cleaners, waxes or solvents to clean the unit.
- ❖ Use under the following conditions:
 - In extremely hot, cold or humid environments.
 - ▶ Ensure that the ambient room temperature is within 5°C ~ 40°C
 - ▶ Relative humidity is 10% ~ 85%
 - In areas susceptible to excessive dust and dirt.
 - Near any appliance generating a strong magnetic field.
 - In direct sunlight.

Eye Safety Warnings



- ❖ Avoid staring/facing directly into the projector beam at all times. Keep your back to the beam as much as possible.
- ❖ When projector is used in a classroom, adequately supervise students when they are asked to point out something on the screen.
- ❖ In order to minimize the lamp power, use room blinds to reduce ambient light levels.



Product Features

- ❖ Product features may vary depending on model.
- ❖ XGA (1024x768) / WXGA (1280x800) Native resolution
- ❖ HD compatible – 720p and 1080p supported
- ❖ BrilliantColor™ Technology
- ❖ Kensington Lock
- ❖ RS232 control
- ❖ Rapid shutdown
- ❖ Full 3D (See page 68)
- ❖ The Product Features shall be configured by the manufacturer as per practical conditions.

Introduction

Package Overview

Unpack and inspect the box contents to ensure all parts listed below are in the box. If something is missing, please contact Optoma customer service.

Standard Accessories

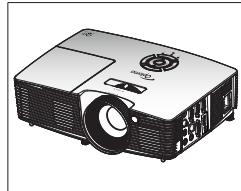

Projector

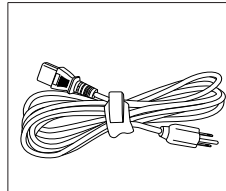

Power Cord

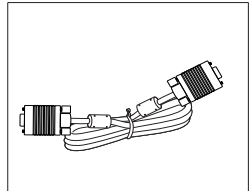

VGA Cable

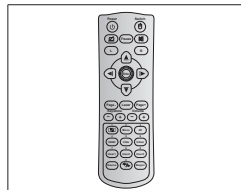

Remote

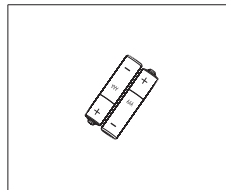

2 × AAA Batteries

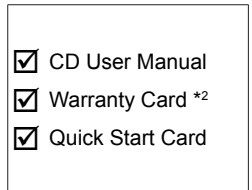

- CD User Manual
- Warranty Card *2
- Quick Start Card

Documentation



- ❖ *1 Optional accessories vary depending on model, specification and region.
- ❖ *2 For European warrant information please visit www.optomaeurope.com.



- Warning:
- ❖ Not all projectors come with a lens cap. For your safety, if the projector is equipped with a lens cap, please ensure to remove it before you turn on the projector.

Optional Accessories *1

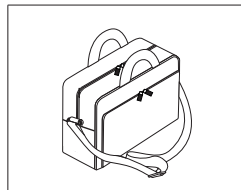

Carry Bag

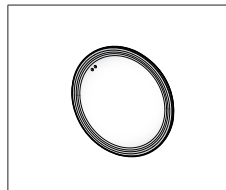

Lens Cap

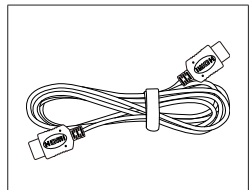

HDMI Cable

Introduction

Product Overview

Main Unit

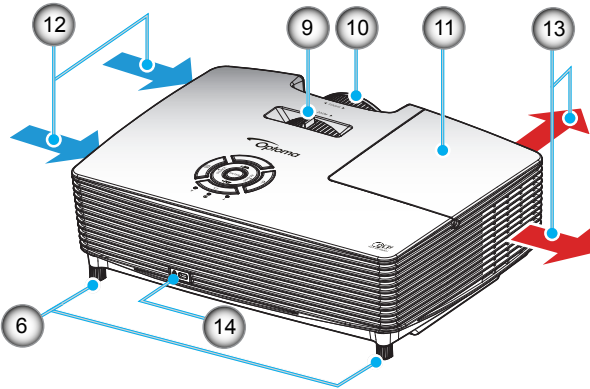
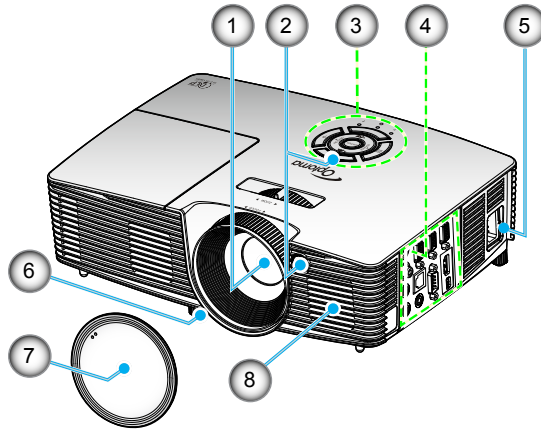

- ❖ Do not block projector in/out air vents.
- ❖ (*) Optional accessory.

Warning:

- ❖ Not all projectors come with a lens cap. For your safety, if the projector is equipped with a lens cap, please ensure to remove it before you turn on the projector.

- | | |
|-------------------------------|---------------------------|
| 1. Lens | 8. Speaker |
| 2. IR Receiver | 9. Zoom Lever |
| 3. Keypad | 10. Focus Ring |
| 4. Input / Output Connections | 11. Lamp Cover |
| 5. Power Socket | 12. Ventilation (inlet) |
| 6. Tilt-Adjustment Feet | 13. Ventilation (outlet) |
| 7. Lens Cap (*) | 14. Kensington™ Lock Port |

Introduction

Keypad

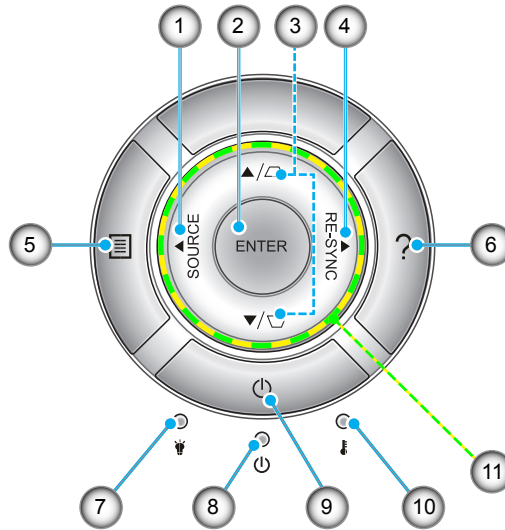

1. Source
2. Enter
3. Keystone Correction
4. Re-Sync
5. Menu
6. Help
7. Lamp LED
8. On/Standby LED
9. Power
10. Temp LED
11. Four Directional Select Keys

Input/Output Connections

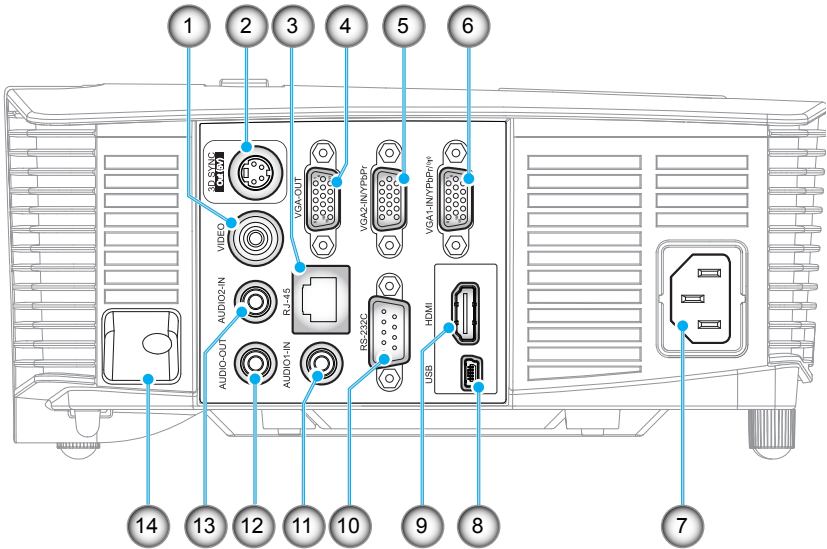

1. Video connector
2. 3D Sync Out (5V) connector
3. RJ-45 connector
4. VGA Out connector
5. VGA2 In / YPbPr connector
6. VGA1 In / YPbPr / (Ⓟ) connector
7. Power Socket
8. USB-B mini connector (Firmware upgrade)
9. HDMI connector
10. RS-232C connector
11. Audio1 In connector
12. Audio Out connector
13. Audio2 In connector
14. Security Bar

NOTE

- ❖ Remote mouse requires special remote.

Introduction

Remote Control



❖ Some keys may have no function for models which do not support these features.

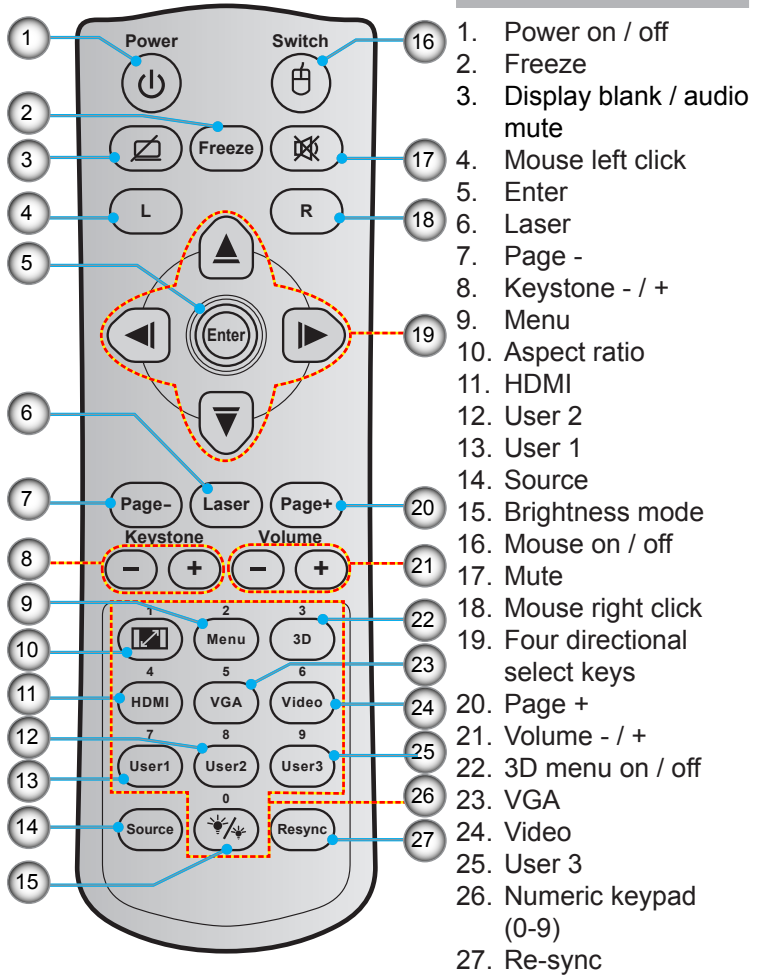

Installation

Connecting to the Projector

Connecting a Computer/Notebook

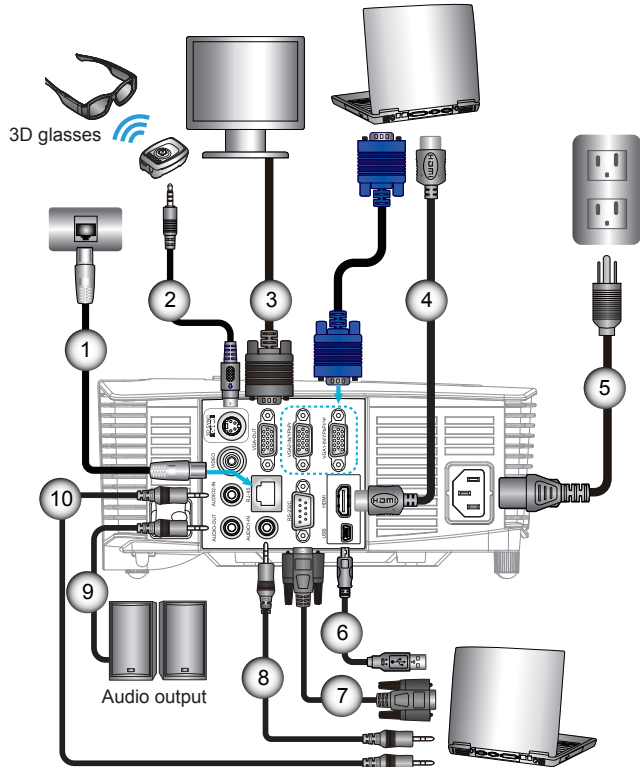

- ❖ Due to the difference in applications for each country, some regions may have different accessories.
- ❖ (*) Optional accessory

1.....	RJ-45 cable
2.....	*3D emitter cable
3.....	VGA cable
4.....	*HDMI cable
5.....	Power cord
6.....	*USB cable
7.....	*RS-232C cable
8.....	*Audio1 In cable
9.....	*Audio Out cable
10.....	*Audio2 In cable

Installation

Connecting a Video source

DVD player, Blu-ray player, Set-top box,
HDTV receiver, Games console

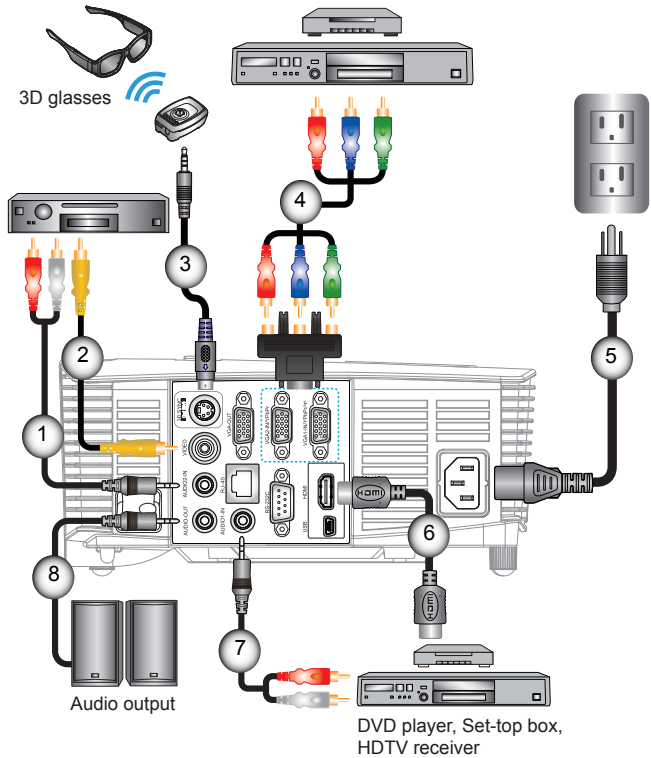

- ❖ Due to the difference in applications for each country, some regions may have different accessories.
- ❖ (*) Optional accessory

1.....	*Audio2 In cable
2.....	*Video cable
3.....	*3D emitter cable
4.....	*3 RCA Component cable
5.....	Power cord
6.....	*HDMI cable
7.....	*Audio1 In cable
8.....	*Audio Out cable

Connect to 3D Video Devices



- ❖ The 3D video source device must be powered on before the 3D projector.

Once you have connected your devices together with HDMI cables, as shown in the diagram, you are ready to begin. Power ON your 3D video source and your 3D projector.

PlayStation® 3 Games

- Make sure that you have updated your console to the latest software version.
- Go to the “Settings menu -> Display settings -> Video output -> HDMI”. Select “Automatic” and follow the on-screen instructions.
- Insert your 3D game disc. Alternatively you can download games (and 3D updates) via the PlayStation® network.
- Launch the game. In the in-game menu, select “Play in 3D”.

Blu-ray 3D™ Player

- Make sure that your player can support 3D Blu-ray™ disc and that 3D output is enabled.
- Insert the 3D Blu-ray™ disc into the player, press “Play”.

3D TV (e.g. SKY 3D, DirectTV)

- Contact your TV service provider to enable any 3D channels on your channel package.
- Once enabled, switch to the 3D channel.
- You should see two images side-by-side.
- Switch to the “SBS Mode” of the 3D projector. The option is located in the “Display” section of the projector OSD menu.

3D Device (e.g. 3D DV/DC) with 2D 1080i side by side signal output

- Connect your 3D device and switch to out 3D content with 2D side-by-side output to 3D Projector.
 - You should see two images side-by-side.
- Switch to the “SBS Mode” of the 3D projector. The option is located in the “Display” section of the projector OSD menu.

If watching 3D content from an HDMI 1.4a source (e.g. 3D Blu-ray) your 3D glasses should always be in sync. If watching 3D content from an HDMI 1.3 source (e.g. 3D broadcast using SBS mode) it may be necessary to use the projector’s 3D Sync-Invert option to optimize your 3D experience. The option is located in the “Display ->3D” section of the projector OSD menu.



- ❖ If input video is normal 2D, please press “3D Format” and switch to “Auto”.
- ❖ If “SBS Mode” is active, 2D video content will not display correctly.

Installation

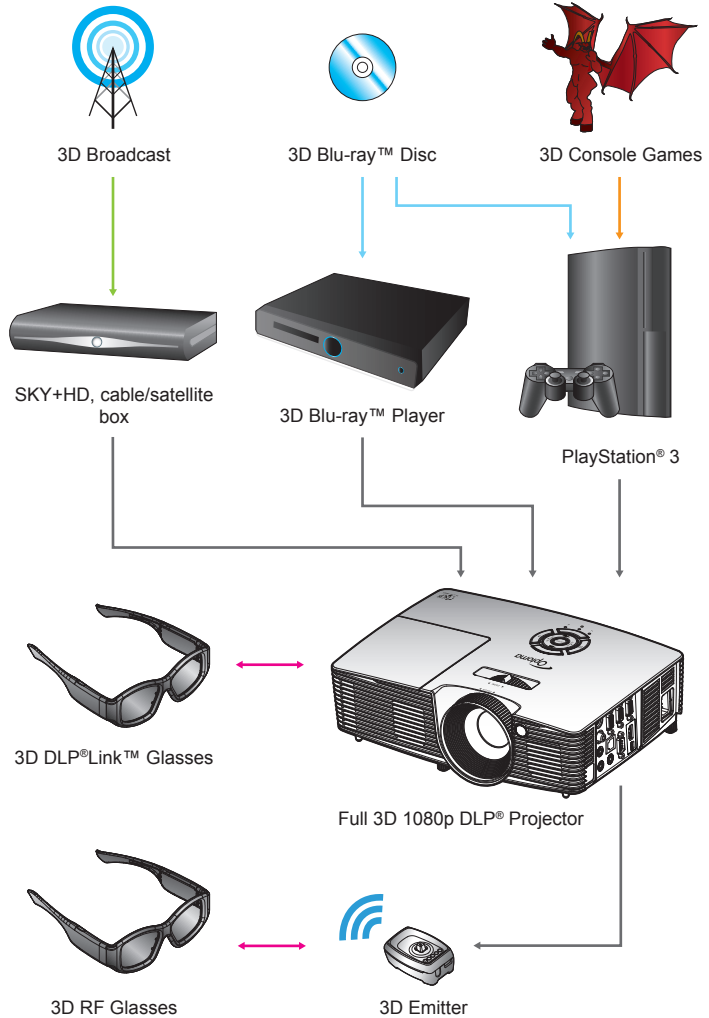



❖ For more detailed information, please refer to 3D glasses user's guide.

Using the 3D glasses

1. To turn ON 3D glasses.
2. Verify that 3D content is being sent to the projector and signal is compatible with projector specifications.
3. Turn on the “3D Mode” (Off/DLP-Link/VESA 3D - depending on which type of glasses you are using) of the 3D projector. The option is located in the “Display” section of the projector OSD menu.
4. Turn on 3D glasses and verify image appears in 3D without eyestrain.
5. If the image does not appear in 3D, please check 3D device set up correctly to send out 3D image or not. Or “SBS Mode” should turn on when input signal is 2D 1080i side-by-side and repeat previous steps 1 ~ 4.
6. It may be necessary to use projector’s “3D Sync-Invert” option to optimize your 3D experience. The option is located in the “Display” section of the projector OSD menu.
7. To turn OFF 3D glasses: Press the “Power” button and hold until the LED switches off.
8. For more detailed information, please refer to the 3D glasses user's guide, or manufacturer's Website.

Powering On/Off the Projector

Powering On the Projector

1. Remove the lens cap. ❶
2. Securely connect the power cord and signal cable. When connected, the On/Standby LED will turn Red.
3. Turn on the lamp by pressing “⏻” button either on the top of the projector or on the remote. The On/Standby LED will now turn Green or Blue. ❷

The startup screen will display in approximately 10 seconds. The first time you use the projector, you will be asked to select the preferred language and power saving mode.

4. Turn on and connect the source that you want to display on the screen (computer, notebook, video player, etc). The projector will detect the source automatically. If not, push menu button and go to “OPTIONS”.
Make sure that the “Source Lock” has been set to “Off”.
- ❖ If you connect multiple sources at the same time, press the “SOURCE” button on the Keypad or direct source keys on the remote control to switch between inputs.



- ❖ Turn on the projector first and then select the signal sources.
- ❖ (*) Optional accessory



- Warning:**
- ❖ Not all projectors come with a lens cap. For your safety, if the projector is equipped with a lens cap, please ensure to remove it before you turn on the projector.

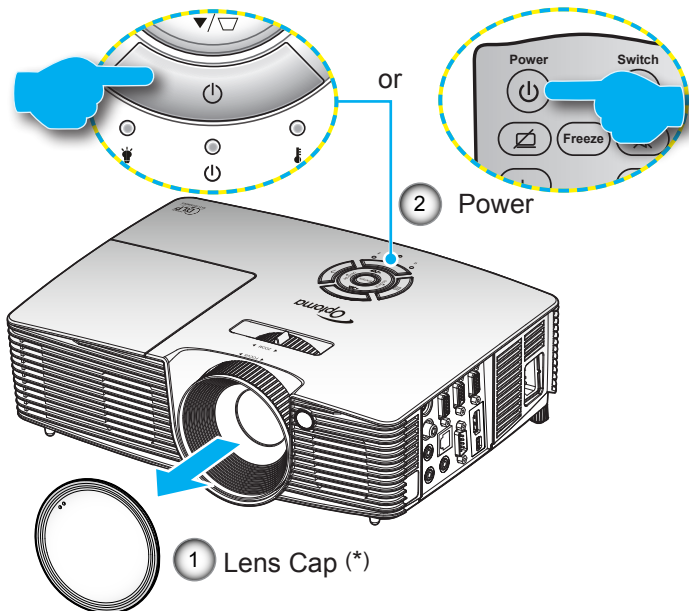

Powering Off the Projector

1. Press the “⏻” button on the remote control or on the Keypad to turn off the projector. The following message will be displayed on the screen.

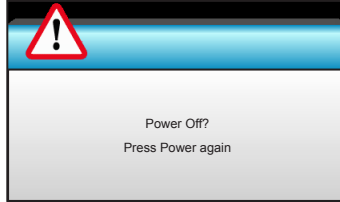

Press the “⏻” button again to confirm otherwise the message will disappear after 15 seconds. When you press the “⏻” button for the second time, the projector will display countdown timer and will shut down.

2. The cooling fans continue to operate for about 10 seconds for cooling cycle and the On/Standby LED will Flash Green or Blue. When the On/Standby LED lights solid Red, the projector has entered standby mode.

If you wish to turn the projector back on, you must wait until the projector has completed the cooling cycle and has entered standby mode. Once in standby mode, simply press “⏻” button to restart the projector.

3. Disconnect the power cord from the electrical outlet and the projector.
4. Do not turn on the projector immediately following a power off procedure.



- ❖ Contact the nearest service center if the projector displays these symptoms. See pages 76-77 for more information.

Warning Indicator

When the warning indicators (see below) come on, the projector will automatically shutdown:

- ❖ “LAMP” LED indicator is lit red and if “On/Standby” indicator flashes red.
- ❖ “TEMP” LED indicator is lit red and if “On/Standby” indicator flashes red. This indicates the projector has overheated. Under normal conditions, the projector can be switched back on.
- ❖ “TEMP” LED indicator flashes red and if “On/Standby” indicator flashes red.

Unplug the power cord from the projector, wait for 30 seconds and try again. If the warning indicator light up again, please contact your nearest service center for assistance.

Adjusting the Projected Image

Adjusting the Projector's Height

The projector is equipped with elevator feet for adjusting the image height.

1. Locate the adjustable foot you wish to modify on the underside of the projector.
2. Rotate the adjustable ring clockwise to raise the projector or counter clockwise to lower it. Repeat with the remaining feet as needed.

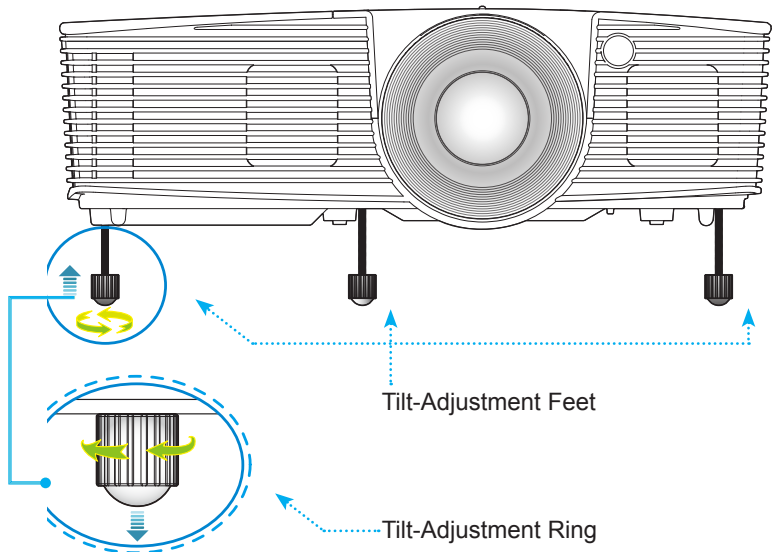

Adjusting the Projector's Zoom / Focus

You may turn the zoom ring to zoom in or out. To focus the image, rotate the focus ring until the image is clear.

- ▶ Standard throw series (XGA): The projector will focus at distances from 3.94 to 32.81 feet (1.2 to 10.0 meters).
- ▶ Standard throw series (WXGA): The projector will focus at distances from 3.94 to 27.23 feet (1.2 to 8.3 meters).

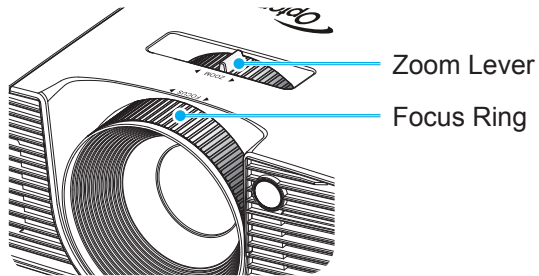

Adjusting Projection Image Size

- ▶ Projection Image Size (XGA) from 30.8" to 307.6" (0.78 to 7.81 meters).

Projection Image Size (WXGA) from 36.3" to 301.0" (0.92 to 7.65 meters).

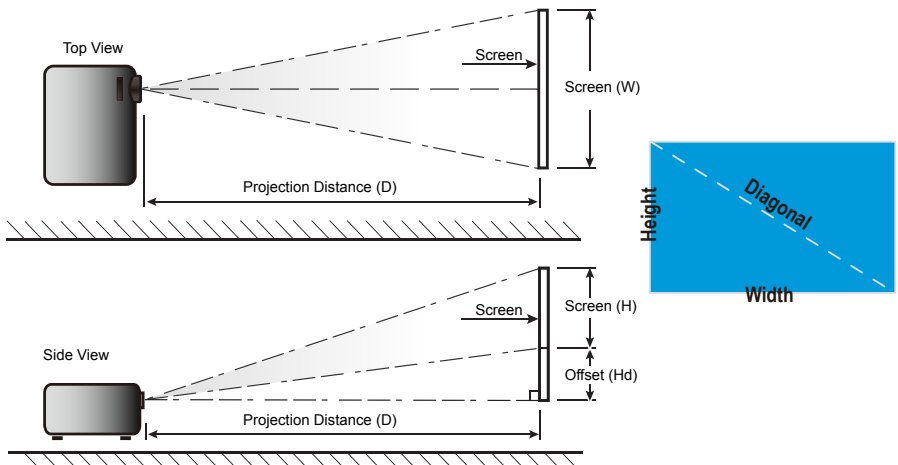

Installation

Standard throw (XGA)

Diagonal length (inch) size of 16:9 Screen	Screen Size W x H				Projection Distance (D)				Offset (Hd)	
	(m)		(inch)		(m)		(feet)			
	Width	Height	Width	Height	wide	tele	wide	tele	(m)	(inch)
30.0	0.61	0.46	24.00	18.00	0.98	1.17	3.2	3.84	0.07	2.70
40.0	0.81	0.61	32.00	24.00	1.30	1.56	4.27	5.12	0.09	3.60
60.0	1.22	0.91	48.00	36.00	1.95	2.34	6.40	7.68	0.14	5.40
70.0	1.42	1.07	56.00	42.00	2.28	2.73	7.47	8.96	0.16	6.30
80.0	1.63	1.22	64.00	48.00	2.60	3.12	8.53	10.24	0.18	7.20
90.0	1.83	1.37	72.00	54.00	2.93	3.51	9.60	11.52	0.21	8.10
100.0	2.03	1.52	80.00	60.00	3.25	3.90	10.67	12.80	0.23	9.00
120.0	2.44	1.83	96.00	72.00	3.90	4.68	12.80	15.36	0.27	10.80
150.0	3.05	2.29	120.00	90.00	4.88	5.85	16.00	19.20	0.34	13.50
180.0	3.66	2.74	144.00	108.00	5.85	7.02	19.20	23.04	0.41	16.20
250.0	5.08	3.81	200.00	150.00	8.13	9.75	26.67	32.00	0.57	22.50
300.0	6.10	4.57	240.00	180.00	9.75	11.70	32.00	38.40	0.69	27.00
307.0	6.24	4.68	245.60	184.20	9.98	11.98	32.75	39.30	0.70	27.63

❖ This table is for user's reference only.

Standard throw (WXGA)

Diagonal length (inch) size of 16:9 Screen	Screen Size W x H				Projection Distance (D)				Offset (Hd)	
	(m)		(inch)		(m)		(feet)			
	Width	Height	Width	Height	wide	tele	wide	tele	(m)	(inch)
30.0	0.65	0.40	25.44	15.90	0.83	0.99	2.71	3.26	0.05	1.97
40.0	0.86	0.54	33.92	21.20	1.10	1.32	3.62	4.34	0.07	2.63
60.0	1.29	0.81	50.88	31.80	1.65	1.99	5.43	6.51	0.10	3.94
70.0	1.51	0.94	59.36	37.10	1.93	2.32	6.33	7.60	0.12	4.60
80.0	1.72	1.08	67.84	42.40	2.21	2.65	7.24	8.68	0.13	5.26
90.0	1.94	1.21	76.32	47.70	2.48	2.98	8.14	9.77	0.15	5.91
100.0	2.15	1.35	84.80	53.00	2.76	3.31	9.05	10.85	0.17	6.57
120.0	2.58	1.62	101.76	63.60	3.31	3.97	10.85	13.03	0.20	7.89
150.0	3.23	2.02	127.20	79.50	4.14	4.96	13.57	16.28	0.25	9.86
180.0	3.88	2.42	152.64	95.40	4.96	5.96	16.28	19.54	0.30	11.83
250.0	5.38	3.37	212.00	132.50	6.89	8.27	22.61	27.14	0.42	16.43
300.0	6.46	4.04	254.40	159.00	8.27	9.93	27.14	32.56	0.50	19.72

❖ This table is for user's reference only.

Keypad & Remote Control

Keypad

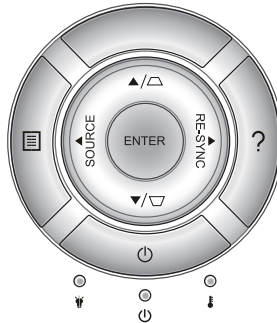

Using the Keypad

POWER		Refer to the “Power On/Off the Projector” section on pages 16-17.
RE-SYNC	RE-SYNC	Automatically synchronize the projector to the input source.
ENTER	ENTER	Confirm your item selection.
SOURCE	SOURCE	Press “SOURCE” to select an input signal.
Menu		Press “Menu” to launch the on-screen display (OSD) menu. To exit OSD, Press “Menu” again.
Help		Help Menu (only available when OSD menu is not shown).
Four Directional Select Keys		Use ▲ ▼ ◀ ▶ to select items or make adjustments to your selection.
Keystone		Use ◁ ▷ to adjust image distortion caused by tilting the projector. (±40 degrees)
Lamp LED		Indicate the projector’s lamp status.
Temp LED		Indicate the projector’s temperature status.
On/Standby LED		Indicate the projector’s status.

User Controls

Remote Control

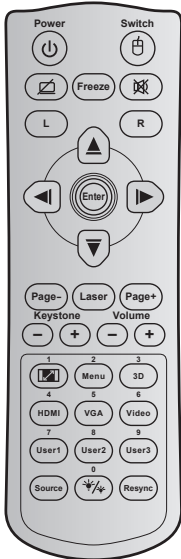

Using the Remote Control

Power		Press to turn on / off the projector.
Switch		Press to switch the USB mouse on / off.
Display blank / audio mute		Press to hide / unhide the screen picture and turn off / on audio.
Freeze		Press to freeze the projector image.
Mute		Press to momentarily turn off / on the audio.
Mouse left click	L	Use as mouse left click.
Mouse right click	R	Use as mouse right click.
Four directional select keys		Use ▲ ▼ ◀ ▶ to select items or make adjustments to your selection.
Enter		Confirm your item selection.
Page -		Press to page down.
Laser		Use as laser pointer.
Page +		Press to page up.
Keystone		Press to adjust image distortion caused by tilting the projector.
Volume		Press to adjust to increase / decrease the volume.
Aspect ratio / 1		<ul style="list-style-type: none"> ▶ Press to change aspect ratio of a displayed image. ▶ Use as numeric keypad number "1".
Menu / 2		<ul style="list-style-type: none"> ▶ Press to display or exit the on-screen display menus for projector. ▶ Use as numeric keypad number "2".

User Controls



Using the Remote Control

3D / 3		<ul style="list-style-type: none"> ▶ Press to manually select a 3D mode that matches your 3D content. ▶ Use as numeric keypad number “3”.
HDMI / 4		<ul style="list-style-type: none"> ▶ Press to choose HDMI source. ▶ Use as numeric keypad number “4”.
VGA / 5		<ul style="list-style-type: none"> ▶ Press to choose VGA source. ▶ Use as numeric keypad number “5”.
Video / 6		<ul style="list-style-type: none"> ▶ Press to choose composite video source. ▶ Use as numeric keypad number “6”.
User1 / 7; User2 / 8; User3 / 9		<ul style="list-style-type: none"> ▶ User defined keys. Please see page 56 to setup. ▶ Use as numeric keypad numbers “7”, “8”, and “9” accordingly.
Source		Press to select an input signal.
Brightness mode / 0		<ul style="list-style-type: none"> ▶ Press to automatically adjust the picture brightness to give an optimum contrast performance. ▶ Use as numeric keypad number “0”.
Re-sync		Press to automatically synchronize the projector to the input source.

Installing Batteries

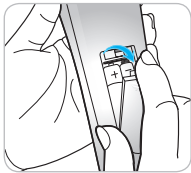
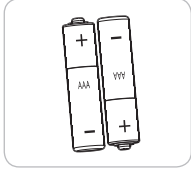

Two size AAA batteries are supplied for Remote Control.

Replace only with the same or equivalent type recommended by the manufacturer.



CAUTION

Improper use of batteries can result in chemical leakage or explosion. Be sure to follow the instructions below.

Do not mix batteries of different types. Different types of batteries have different characteristics.

Do not mix old and new batteries. Mixing old and new batteries can shorten the life of new batteries or cause chemical leakage in old batteries.

Remove batteries as soon as they are worn out. Chemicals that leak from batteries that come in contact with skin can cause a rash. If you find any chemical leakage, wipe thoroughly with a cloth.

The batteries supplied with this product may have a shorter life expectancy due to storage conditions.

If you will not be using the remote control unit for an extended period of time, remove batteries from it.

When you dispose of the battery, you must obey the law in the relative area or country.

User Controls

Using the HELP button

The HELP function ensures easy setup and operation.

- ▶ Press the “?” button on the Keypad to open the Help Menu.

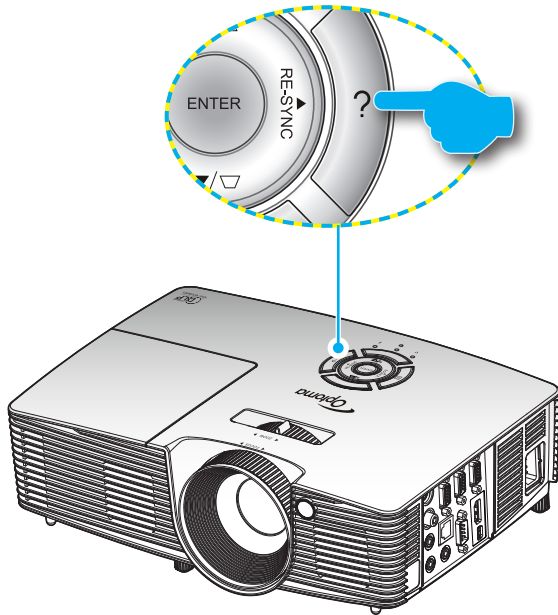

- ▶ Help menu button functions only when no input source is detected.



- ❖ Please refer to the “Troubleshooting” section on pages 60~62 for more details.

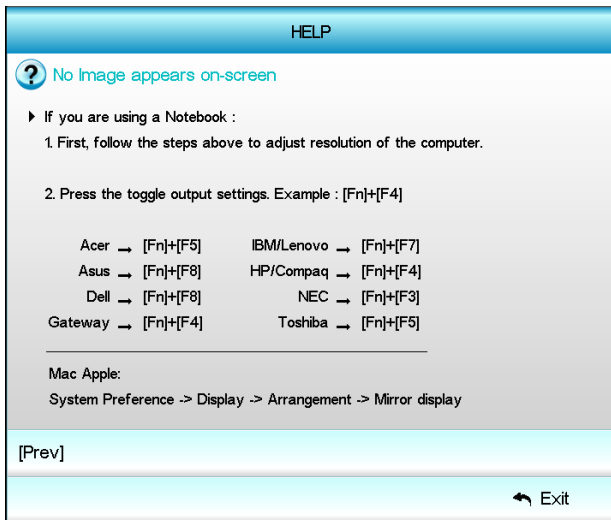
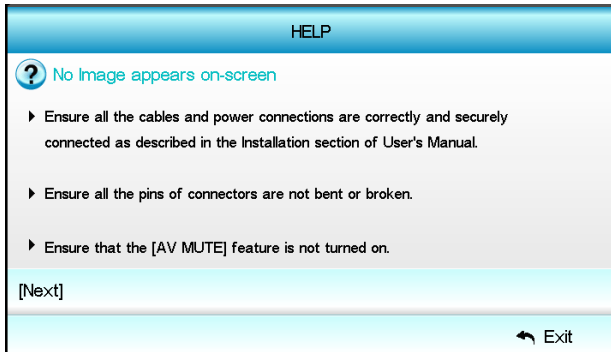
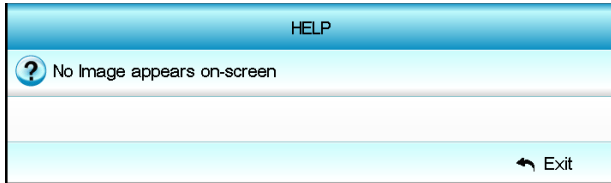

User Controls

- ▶ If input source is detected and help button is pressed, the following pages will appear to help diagnose any problems.

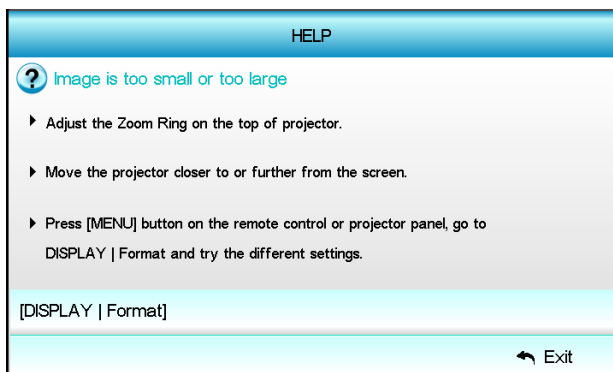
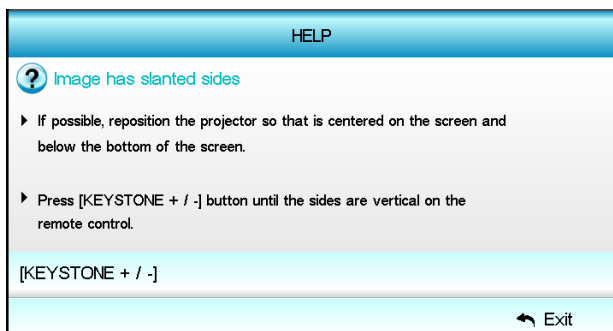
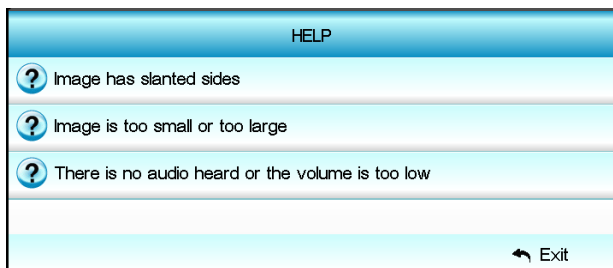

User Controls

HELP

? There is no audio heard or the volume is too low

? Is the volume setting at the minimum?
▶ Turn up the volume setting.

? Is the cable connected properly to the projector?
▶ Check the physical connection and ensure the cable is connected properly from the source to projector.

[Volume]

↩ Exit

On-screen Display Menus

The Projector has multilingual On-screen Display menus that allow you to make image adjustments and change a variety of settings. The projector will automatically detect the source.

How to operate

1. To open the OSD menu, press “Menu” on the Remote Control or Keypad.
2. When OSD is displayed, use ◀▶ keys to select any item in the main menu. While making a selection on a particular page, press ▼ or “Enter” key to enter sub menu.
3. Use ▲▼ keys to select the desired item in the sub menu and then press ▶ or “Enter” key to view further settings. Adjust the settings by ◀▶ key.
4. Select the next item to be adjusted in the sub menu and adjust as described above.
5. Press “Enter” or “Menu” to confirm, and the screen will return to the main menu.
6. To exit, press “Menu” again. The OSD menu will close and the projector will automatically save the new settings.

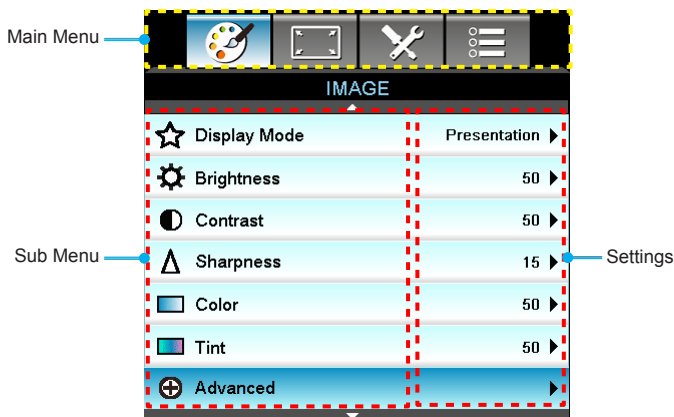









User Controls

Menu Tree

Main Menu	Sub Menu	Settings		
IMAGE	Display Mode	Presentation / Bright / Movie / sRGB / Blackboard / DICOM SIM. / User / 3D		
	Brightness	-50~+50		
	Contrast	-50~+50		
	Sharpness	1~15		
	Color	-50~+50		
	Tint	-50~+50		
	Advanced	Gamma	Film / Video / Graphics / Standard / Blackboard / DICOM SIM.	
		BrilliantColor™	1 to 10	
		Color Temp.	Warm / Medium / Cold	
		Color Settings	Red / Green / Blue / Cyan / Magenta / Yellow	Hue / Saturation / Gain [-50~50]
			White	Red / Green / Blue [-50~50]
			Reset	Yes / No
		Color Space	Not HDMI Input: Auto / RGB / YUV HDMI Input: Auto / RGB (0-255) / RGB (16-235) / YUV	
		Signal	Automatic	On / Off
			Phase (VGA)	
			Frequency (VGA)	
	H. Position (VGA)			
	V. Position (VGA)			
	Exit			
	Reset	Yes / No		
DISPLAY	Format	XGA: 4:3, 16:9, Native, Auto / WXGA: 4:3, 16:9, or 16:10, LBX, Native, Auto		
	Edge Mask	0~10		
	Zoom	-5~25		
	Image Shift	H	Right / Left (icon in the center) -100~+100	
		V	Up / Down (icon in the center) -100~+100	
	V Keystone	-40~+40		
	3D	3D Mode	Off / DLP-Link / VESA 3D	
		3D Format	Auto / SBS / Top and Bottom / Frame Sequential	
		3D -> 2D	3D / L / R	
		3D Sync. Invert	On / Off	
		Exit		
	Exit			
SETUP	Language	English / Deutsch / Français / Italiano / Español / Português / Svenska / Nederlands / Norsk/Dansk / Polski / Русский / Suomi / ελληνικά / Magyar / Čeština / عربي / 繁體中文 / 简体中文 / 日本語 / 한국어 / ភាសាខ្មែរ / Türkçe / فارسی / Tiếng Việt / Română / Bahasa Indonesia		

User Controls

Main Menu	Sub Menu	Settings	
	Projection	   	
	Menu Location	    	
	Screen Type		16:10 / 16:9 (WXGA)
	Audio Settings	Internal Speaker	On / Off
		Mute	On / Off
		Volume	Audio (0~10)
		Audio Input	Default / Audio 1 / Audio 2
		Audio Out (Standby)	On / Off
		Exit	
	Security	Security	On / Off
		Security Timer	Month (0~12 /) Day (0~30 /) Hour (0~24 /) Exit
		Change Password	
		Exit	
	Projector ID		00~99
	Network	LAN Settings	Network Status Connected / Disconnected (Read-Only)
			DHCP On / Off
			IP Address
			Subnet Mask
			Gateway
			DNS
			MAC Address Read-Only
			Exit
		Control Settings	Crestron On / Off (port:41794)
			Extron On / Off (port: 2023)
			PJ Link On / Off (port: 4352)
			AMX Device Discovery On / Off (port: 1023)
			Telnet On / Off (port: 23)
			HTTP On / Off (port: 80)
			Apply Yes / No
	Advanced	Logo	Default / Neutral
		Logo Capture	
		Closed Captioning	Off / CC1 / CC2
		Wireless	On / Off
		Exit	
	Exit		
OPTIONS	Input Source		VGA1 / VGA2 / Video / HDMI
	Source Lock		On / Off

User Controls

Main Menu	Sub Menu	Settings
	High Altitude	On / Off
	Information Hide	On / Off Warning messages & Power off not hidden
	Keypad Lock	On / Off
	Test Pattern	None / Grid / White Pattern
	IR Function	On / Off / Top / Front
	Background Color	Black / Red / Blue / Green / White
Lamp Settings	Lamp Hours	0~ 9999
	Lamp Reminder	On / Off
	Lamp Mode	Bright / Eco. / Dynamic / Eco+
	Lamp Reset	Yes / No
	Exit	
Remote Settings	USER 1	VGA2 / LAN / Brightness / Contrast / Sleep Timer
	USER 2	VGA2 / LAN / Brightness / Contrast / Sleep Timer
	USER 3	VGA2 / LAN / Brightness / Contrast / Sleep Timer
	Direct Power On	On / Off
	Auto Power Off (min.)	0-180 [One step: 5 minutes]
	Sleep Timer (min.)	0-990 [One step: 30 minutes]
	Quick Resume	On / Off
	Power Mode (Standby)	Active / Eco.
Optional Filter Settings	Filter Usage Hours	Read-Only [Range 0~9999]
	Optional Filter Installed	Yes / No
	Filter Reminder	Off / 300 hr / 500 hr / 800 hr / 1000 hr
	Filter Reset	Yes / No
	Exit	
Reset		Yes / No
Exit		

IMAGE

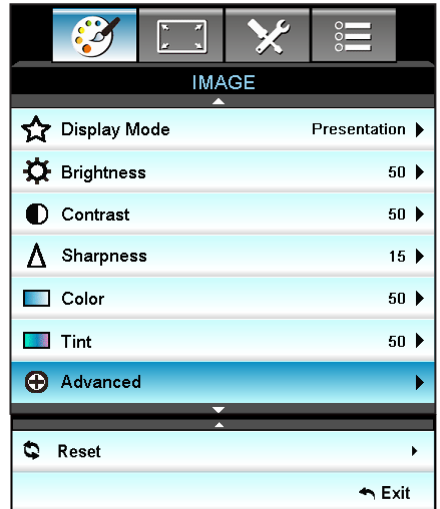

Display Mode

There are many factory presets optimized for various types of images.

- ▶ Presentation: This mode is suitable for showing in front of public in connection to the PC.
- ▶ Bright: Maximum brightness from PC input.
- ▶ Movie: This mode is suitable for watching video.
- ▶ sRGB: Standardized accurate color.
- ▶ Blackboard: This mode should be selected to achieve optimum color settings when projecting onto a blackboard (green).
- ▶ DICOM SIM.: This mode can project a monochrome medical image such as an X ray radiography, MRI, etc.
- ▶ User: Memorize user's settings.
- ▶ 3D: To experience the 3D effect, you need to have 3D glasses, make sure your PC/portable device has a 120 Hz signal output quad buffered graphics card and have a 3D Player installed.

Brightness

Adjust the brightness of the image.

- ▶ Press the ◀ to darken image.
- ▶ Press the ▶▶ to lighten the image.

User Controls

Contrast

The contrast controls the degree of difference between the lightest and darkest parts of the picture.

- ▶ Press the ◀ to decrease the contrast.
- ▶ Press the ▶ to increase the contrast.

Sharpness

Adjust the sharpness of the image.

- ▶ Press the ◀ to decrease the sharpness.
- ▶ Press the ▶ to increase the sharpness.

Color

Adjust a video image from black and white to fully saturated color.

- ▶ Press the ◀ to decrease the amount of saturation in the image.
- ▶ Press the ▶ to increase the amount of saturation in the image.

Tint

Adjust the color balance of red and green.

- ▶ Press the ◀ to increase the amount of green in the image.
- ▶ Press the ▶ to increase the amount of red in the image.

Reset

Choose "Yes" to return the factory default settings for "IMAGE".

Exit

Choose "Exit" to exit the menu.

IMAGE | Advanced

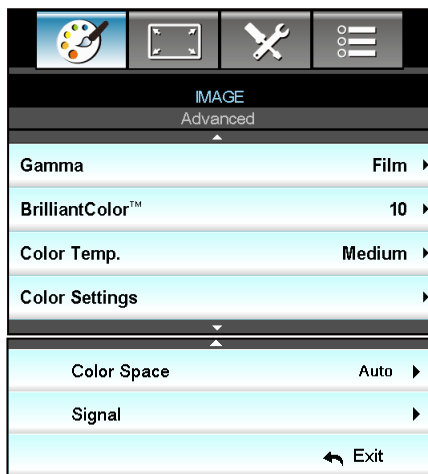

Gamma

This allows you to set up gamma curve type. After the initial setup and fine tuning is completed, utilize the Gamma Adjustment steps to optimize your image output.

- ▶ Film: for home theater.
- ▶ Video: for video or TV source.
- ▶ Graphics: for PC / Photo source.
- ▶ Standard: for standardized setting.
- ▶ Blackboard: This mode should be selected to achieve optimum color settings when projecting onto a blackboard (green).
- ▶ DICOM SIM.: This mode can project a monochrome medical image such as an X ray radiography, MRI, etc.

BrilliantColor™

This adjustable item utilizes a new color-processing algorithm and enhancements to enable higher brightness while providing true, more vibrant colors in picture. The range is from “1” to “10”. If you prefer a stronger enhanced image, adjust toward the maximum setting. For a smoother, more natural image, adjust toward the minimum setting.

User Controls

Color Temp.

Select a color temperature from Warm, Medium and Cold.

Color Settings

Press ► into the next menu and then use ▲ or ▼ or ◀ or ▶ to select item.



- ▶ Red/Green/Blue/Cyan/Magenta/Yellow: Use ◀ or ▶ to select Hue, Saturation and Gain Colors.

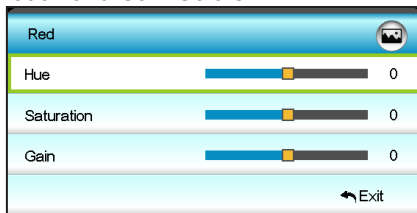

- ▶ White: Use ◀ or ▶ to select Red, Green and Blue Colors.

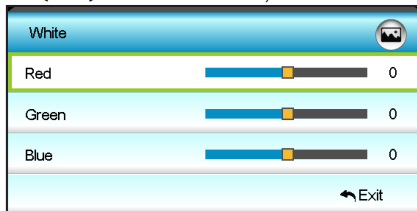

- ▶ Reset: Choose “↻ Reset” to return the factory default settings for color adjustments.

Color Space

Select an appropriate color matrix type from the following:

- ▶ Non-HDMI Input: Auto, RGB or YUV.
- ▶ HDMI Input: Auto, RGB(0-255), RGB(16-235) or YUV.

Exit

Choose “Exit” to exit the menu.

IMAGE | Advanced | Signal (RGB)

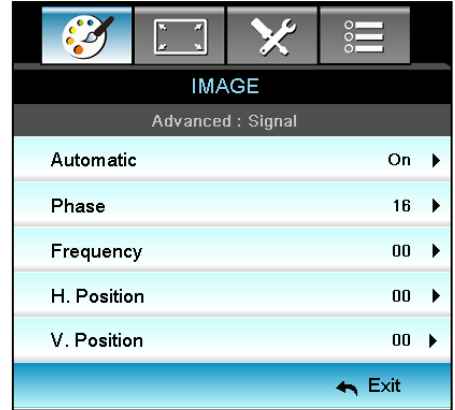

- ❖ “Signal” is only supported in Analog VGA (RGB) signal.
- ❖ If “Signal” is automatic, the phase, frequency items are grayed out, and if “Signal” is not automatic, the phase, frequency items will appear for the user to manually tune and are saved in the settings after that for the next time projector is turned off and on again.

Automatic

Automatically selects the signal. If you use this function, the Phase, frequency items are grayed out, and if Signal is not automatic, the phase, frequency items will appear for user to manually tune and saved in settings after that for next time projector turns off and on again.

Phase

Synchronize the signal timing of the display with the graphic card. If the image appears to be unstable or flickers, use this function to correct it.

Frequency

Change the display data frequency to match the frequency of your computer’s graphic card. Use this function only if the image appears to flicker vertically.

H. Position

- ▶ Press the ◀ to move the image left.
- ▶ Press the ▶ to move the image right.

V. Position

- ▶ Press the ◀ to move the image down.
- ▶ Press the ▶ to move the image up.

Exit

Choose “Exit” to exit the menu.

DISPLAY



Format

Use this function to choose your desired aspect ratio.

XGA

- ▶ 4:3: This format is for 4:3 input sources.
- ▶ 16:9: This format is for 16:9 input sources, like HDTV and DVD enhanced for Wide screen TV.
- ▶ Native: This format displays the original image without any scaling.
- ▶ AUTO: Automatically selects the appropriate display format.

Source	480i/p	576i/p	1080i/p	720p
4:3	Scale to 1024 x 768			
16:9	Scale to 1024 x 576			
Native	No scaling will be made; the resolution is dependent on which input source and is then displayed.			
Auto	<ul style="list-style-type: none">▶ If source is 4:3, it will be auto resized to 1024 x 768▶ If source is 16:9, it will be auto resized to 1024 x 576▶ If source is 15:9, it will be auto resized to 1024 x 614▶ If the source is 16:10, it will be auto resized to 1024 x 640			

User Controls

WXGA

- ▶ 4:3: This format is for 4:3 input sources.
- ▶ 16:9: This format is for 16:9 input sources, like HDTV and DVD enhanced for Wide screen TV.
- ▶ 16:10: This format is for 16:10 input sources, like widescreen laptops.
- ▶ LBX: This format is for non-16x9, letterbox source and for users who use external 16x9 lens to display 2.35:1 aspect ratio using full resolution.
- ▶ Native: This format displays the original image without any scaling.
- ▶ AUTO: Automatically selects the appropriate display format.

Detail informations about LBX mode:

1. Some Letter-Box Format DVDs are not enhanced for 16x9 TVs. In this situation, the image will not look right when displayed in 16:9 mode. In this situation, please try to using the 4:3 mode to view the DVD. If the content is not 4:3, there will be black bars around the image in 16:9 display. For this type of content, you can use LBX mode to fill the image on the 16:9 display.
2. If you use an external anamorphic lens, this LBX mode also allows you to watch a 2.35:1 content (include Anamorphic DVD and HDTV film source) that support anamorphic wide is enhanced for 16x9 Display in a wide 2.35:1 image. In this case, there are no black bars. Lamp power and vertical resolution are fully utilized.

16:9 Screen	480i/p	576i/p	1080i/p	720p	PC
4:3	Scale to 960 x 720				
16:9	Scale to 1280 x 720				
LBX	Scale to 1280 x 960, in order to get the central 1280 x 720 image displayed on the screen.				
Native	1:1 mapping centered		1:1 mapping display 1280 x 720	1280 x 720 centered	1:1 mapping centered
Auto	<ul style="list-style-type: none"> ▶ If this format is selected, the screen type will automatically set to 16:9 (1280 x 720) ▶ If source is 4:3, it will be auto resized to 960 x 720 ▶ If source is 16:9, it will be auto resized to 1280 x 720 ▶ If source is 15:9, it will be auto resized to 1200 x 720 ▶ If the source is 16:10, it will be auto resized to 1152 x 720 				

User Controls

16:10 Screen	480i/p	576i/p	1080i/p	720p	PC
4:3	Scale to 1066 x 800				
16:10	Scale to 1280 x 800				
LBX	Scale to 1280 x 960, in order to get the central 1280 x 800 image displayed on the screen.				
Native	1:1 mapping centered	1:1 mapping display 1280 x 800	1280 x 720 centered	1:1 mapping centered	
Auto	<ul style="list-style-type: none"> ▶ Input source will be fit into 1280x800 display area and be kept its original aspect ratio ▶ If source is 4:3, auto resize to 1066 x 800 ▶ If source is 16:9 auto resize to 1280 x 720 ▶ If source is 15:9 auto resize to 1280 x 768 ▶ If source is 16:10 auto resize to 1280 x 800 				



- ❖ Each I/O has different setting of "Edge Mask".
- ❖ "Edge Mask" and "Zoom" can't work at same time.

Edge Mask

Edge mask the image to remove video encoding noise on the edge of video source.

Zoom

- ▶ Press the ◀ to reduce the size of an image.
- ▶ Press the ▶ to magnify an image on the projection screen.

Image Shift

Press ► into the next menu as below and then use ▲ or ▼ or ◀ or ▶ to select item.

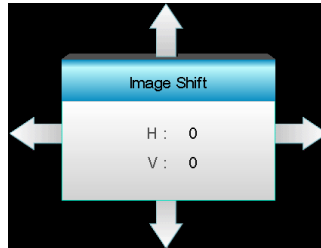

- ▶ H: Press the ◀▶ to shift the projected image position horizontally.
- ▶ V: Press the ▲▼ to shift the projected image position vertically.

V Keystone

Press the ◀ or ▶ to adjust image distortion vertically and make a squarer image.

Exit

Choose "Exit" to exit the menu.

DISPLAY | 3D

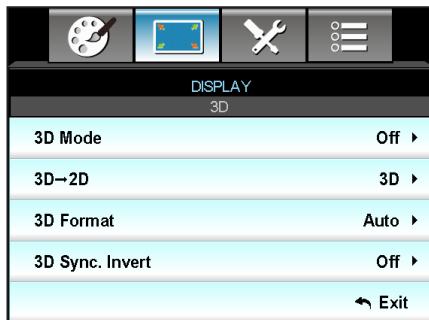

- ❖ 3D Format is only supported on 3D Timing on page 69.
- ❖ “3D Format” is only supported on non-HDMI 1.4a 3D timing.

3D Mode

- ▶ Off: Select “Off” to turn off 3D mode.
- ▶ DLP-Link: Select “DLP-Link” to use optimized settings for DLP Link 3D Glasses. (refer to page 15).
- ▶ VESA 3D: Select “VESA 3D” to use optimized setting for VESA 3D Glasses. (refer to page 15).

3D -> 2D

- ▶ 3D: Display 3D signal.
- ▶ L (Left): Display the left frame of 3D content.
- ▶ R (Right): Display the right frame of 3D content.

3D Format

- ▶ Auto: When a 3D identification signal is detected, the 3D format is selected automatically.
- ▶ SBS: Display 3D signal in “Side-by-Side” format.
- ▶ Top and Bottom: Display 3D signal in “Top and Bottom” format.
- ▶ Frame Sequential: Display 3D signal in “Frame Sequential” format.

3D Sync. Invert

- ▶ Press the “On” to invert left and right frame contents.
- ▶ Press the “Off” for default frame contents.

Exit

Choose “Exit” to exit the menu.

SETUP

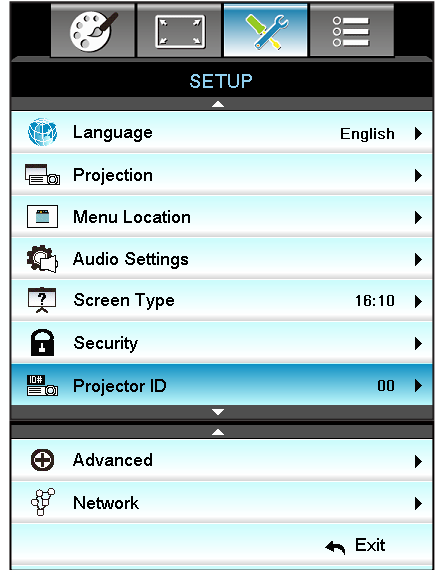

Language

Choose the multilingual OSD menu. Press **▶** into the sub menu and then use the **▲** or **▼** or **◀** or **▶▶** key to select your preferred language. Press “Enter” to finalize the selection.

Language Selection			
English	Nederlands	Čeština	Türkçe
Deutsch	Norsk/Dansk	عربي	فارسی
Français	Polski	繁體中文	Tiếng Việt
Italiano	Русский	简体中文	Română
Español	Suomi	日本語	Bahasa Indonesia
Português	ελληνικά	한국어	
Svenska	Magyar	ไทย	↩ Exit

User Controls



- ❖ Rear-Desktop and Rear-Ceiling are to be used with a translucent screen.



- ❖ "Screen Type" is for WXGA only.

Projection

- ▶  Front-Projection

This is the default selection. The image is projected straight on the screen.

- ▶  Rear-Desktop

When selected, the image will appear reversed.

- ▶  Front-Ceiling

When selected, the image will turn upside down.

- ▶  Rear-Ceiling

When selected, the image will appear reversed in upside down position

Menu Location

Choose the menu location on the display screen.

Screen Type

Choose the screen type from 16:10 or 16:9.

Projector ID

ID definition can be set up by menu (range 0-99), and allow user control an individual projector by RS232.

Exit

Choose "Exit" to exit the menu.

SETUP | Audio Settings

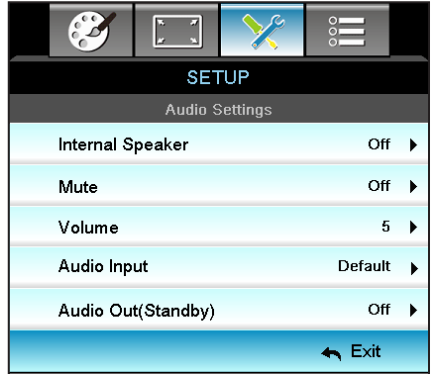

- ❖ "Mute" function affects both internal and external speaker volume.

Internal Speaker

Choose the "On" or "Off" to turn on or off the internal speaker.

Mute

- ▶ Choose the "On" to turn mute on.
- ▶ Choose the "Off" to turn mute off.

Volume

- ▶ Press the ◀ to decrease the volume.
- ▶ Press the ▶ to increase the volume.

Audio Input

The default audio settings are on the back panel of the projector. Use this option to reassign any of the Audio Inputs (1 or 2) to the current image source. Each Audio input can be assigned to more than one video source.

- ▶ Default.
- ▶ Audio 1: VGA 1 and VGA 2.
- ▶ Audio 2: Video.

Audio Out (Standby)

Choose the "On" or "Off" to turn on or off the audio out.

Exit

Choose "Exit" to exit the menu.

SETUP | Security



Security

- ▶ On: Choose "On" to use security verification when the turning on the projector.
- ▶ Off: Choose "Off" to be able to switch on the projector without password verification.

Security Timer

Can be select the time (Month/Day/Hour) function to set the number of hours the projector can be used. Once this time has elapsed you will be requested to enter your password again.

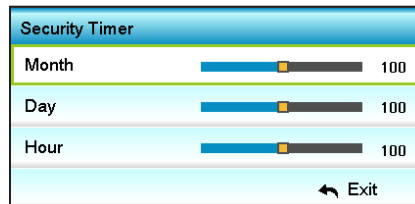



- ❖ Pass-code default value is “1234” (first time).

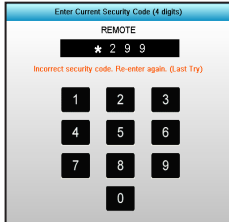

Change Password

- ▶ First time:
 1. Press “Enter” key to set the password.
 2. The password has to be 4 digits.
 3. Use number button on the remote or on-screen numeric keypad to enter your new password and then press “Enter” key to confirm your password.
- ▶ Change Password:

(If your remote does not have a number keypad, please use the up/down arrows to change each digit of the password, then press enter to confirm)

 1. Press “Enter” to input old password.
 2. Use number button or on-screen numeric keypad to enter current password and then press “Enter” to confirm.
 3. Enter new password (4 digits in length) using the number buttons on the remote, then press “Enter” to confirm.
 4. Enter new password again and press “Enter” to confirm.
- ▶ If the incorrect password is entered 3 times, the projector will automatically shut down.
- ▶ If you have forgotten your password, please contact your local office for support.

SETUP | Network|LAN Settings

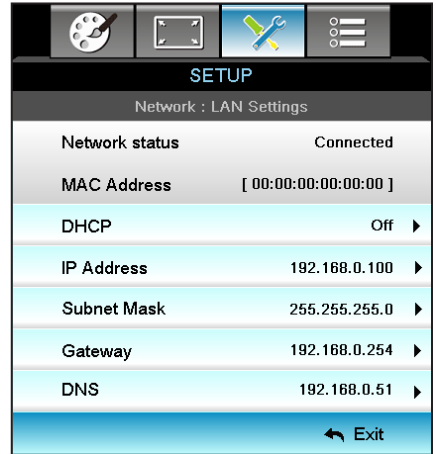

Network Status

Display the network connection status (read-only).

MAC Address

Display the MAC address (read-only).

DHCP

- ▶ On: Projector will obtain an IP address automatically from your network.
- ▶ Off: To assign IP, Subnet Mask, Gateway and DNS configuration manually.

Exiting OSD will automatically apply the entered values.

IP Address

Display the IP address.

Subnet Mask

Display subnet mask number.

Gateway

Display the default gateway of the network connected to the projector.

DNS

Display DNS number.

Exit

Choose "Exit" to exit the menu.

User Controls

How to use web browser to control your projector



- ❖ The default user name and password is “admin”.

1. Turn “On” the DHCP option on projector to allow a DHCP server to automatically assign an IP address.
2. Open the web browser in your PC and type in the projector’s IP address (**Network: LAN Settings > IP Address**).
3. Enter the user name and password, and click “**Login**”.
The projector’s configuration web interface opens.

Making a direct connection from your computer to the projector*



- ❖ *The steps in this section base on Windows7 operating system.

Step 1: Turn “Off” the DHCP option on project.

Step 2: Configure the IP address, Subnet Mask, Gateway, and DNS on projector (**Network: LAN Settings**).

IP Address	192.168.0.100
Subnet Mask	255.255.255.0
Gateway	192.168.0.254
DNS	192.168.0.51

Step 3: Open Network and Sharing Center page on your PC, and assign the identical network parameters to your PC as set on projector. Click **OK** to save the parameters.

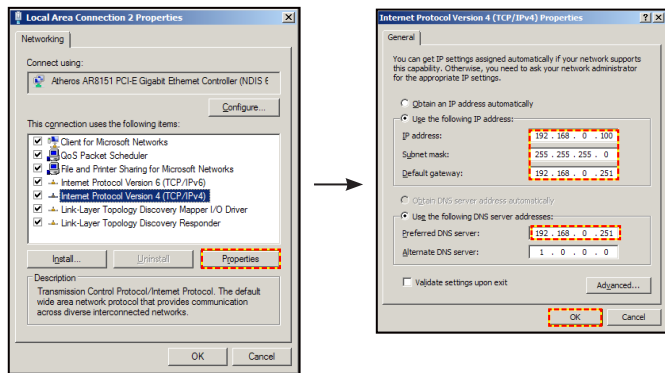

Step 4: Open the web browser on your PC and type in the URL field the IP address, assigned in step 3. Then press “**Enter**” key.

SETUP | Network|Control Settings

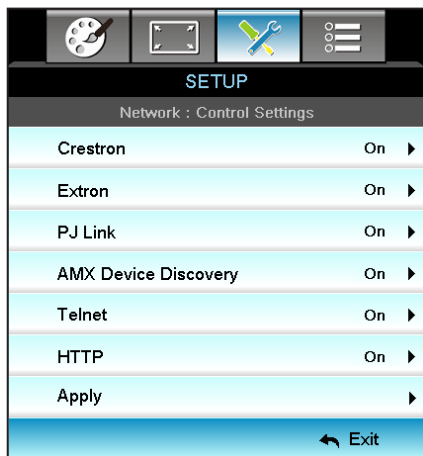

Crestron

Use this function to select the network function (port: 41794). For more information, please visit <http://www.crestron.com> and www.crestron.com/getroomview.

Extron

Use this function to select the network function (port: 2023).

PJ Link

Use this function to select the network function (port: 4352).

AMX Device Discovery

Use this function to select the network function (port: 1023).

Telnet

Use this function to select the network function (port: 23).

HTTP

Use this function to select the network function (port: 80).

Apply

Press ► and then choose "Yes" to apply the selection.

Exit

Choose "Exit" to exit the menu.

SETUP | Advanced

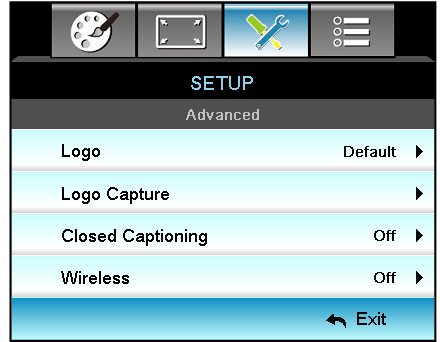

- ❖ For a successful logo capture, ensure that the on-screen image does not exceed the projector native resolution. (1080p: 1920 x 1080).

Logo

Use this function to set the desired startup screen. If changes are made they will take effect the next time the projector is powered on.

- ▶ Default: The default startup screen.
- ▶ Neutral: Logo is not displayed on startup screen.

Logo Capture

Press ▶ to capture an image of the picture currently displayed on screen.

Closed Captioning

Closed Captioning is a text version of the program sound or other information displayed on the screen. If the input signal contains closed captions, you can turn on the feature and watch the channels. Press ◀ or ▶ to select Off, CCI, or CC2.

Wireless

Choose the “On” or “Off” to turn on or off the wireless function.

Exit

Choose “Exit” to exit the menu.

OPTIONS

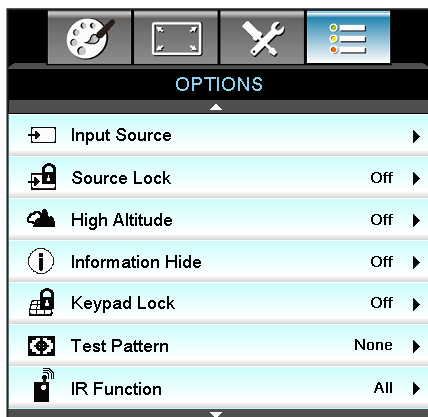

Input Source

Use this option to enable/disable input sources. Press ▶ to enter the sub menu and select which sources you require. Press “Enter” to finalize the selection. The projector will only search for inputs that are enabled.

Source Lock

- ▶ On: The projector will only search current input connection.
- ▶ Off: The projector will search for other signals if the current input signal is lost.

High Altitude

When “On” is selected, the fans will spin faster. This feature is useful in high altitude areas where the air is thin.

Information Hide

- ▶ On: Choose “On” to hide the info message.
- ▶ Off: Choose “Off” to show the “searching” message.

Keypad Lock

When the keypad lock function is “On”, the Keypad will be locked however, the projector can be operated by the remote control. By selecting “Off”, you will be able to reuse the Keypad.

Test Pattern

Display a test pattern. There are Grid, White Pattern and None.



- ❖ “Front” and “Top” can’t be selected under standby mode.
- ❖ IR mode can be switched to “NVIDIA 3D Vision” once implemented and verified by NVIDIA.

IR Function

- ▶ All: Choose “All”, the projector can be operated by the remote control from front or top IR receiver.
- ▶ Front: Choose “Front”, the projector can be operated by the remote control from front IR receiver.
- ▶ Top: Choose “Top”, the projector can be operated by the remote control from top IR receiver.
- ▶ Off: Choose “Off”, the projector can’t be operated by the remote control from front or top IR receiver. By selecting “Off”, you will be able to use the Keypad keys.

OPTIONS

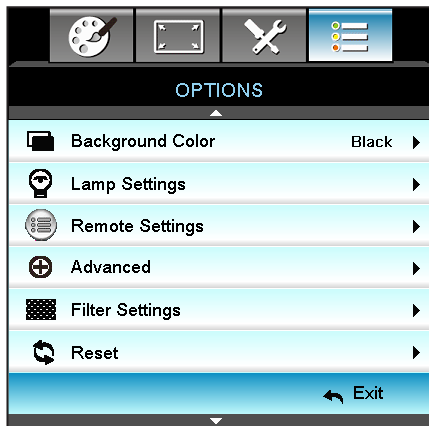

Background Color

Use this feature to display a “Black”, “Red”, “Blue”, “Green” or “White”, screen when no signal is available.

Reset

Choose “Yes” to return the display parameters on all menus to the factory default settings.

Exit

Choose “Exit” to exit the menu.

OPTIONS | Lamp Settings



- ❖ When ambient temperature is over 40 °C in operating, the projector will switch to Eco automatically.
- ❖ "Lamp Mode" can be independently set for 2D and 3D.
- ❖ Dynamic mode-lamp power can be dynamically adjusted from 100% to 30%.

Lamp Hours

Display the projection time.

Lamp Reminder

Choose this function to show or to hide the warning message when the changing lamp message is displayed.

The message will appear 30 hours before suggested replacement of lamp.

Lamp Mode

- ▶ Bright: Choose "Bright" to increase the brightness.
- ▶ Eco.: Choose "Eco." to dim the projector lamp which will lower power consumption and extend the lamp life.
- ▶ Dynamic: Choose "Dynamic" to dim the lamp power which will be based on brightness level of the content and adjust lamp power consumption between 100% and 30% dynamically. The lamp life will be extended.
- ▶ Eco+: When Eco+ mode is activated, the brightness level of the content is automatically detected to significantly reduced lamp power consumption (up to 70%) during periods of inactivity.

Lamp Reset

Resets the lamp hour counter after replacing the lamp.

Exit

Choose "Exit" to exit the menu.

User Controls

Lamp Behavior in different mode and function:

Brightness Mode	Bright	Eco	Dynamic
White Pattern	100%	80%	100%
Dimming range	N/A	N/A	100%~30%
Black Pattern	100%	80%	30% (Extra dimming)
AV Mute	30% (Extra dimming)	30% (Extra dimming)	30% (Extra dimming)
Quick Resume	30% (Extra dimming)	30% (Extra dimming)	30% (Extra dimming)

OPTIONS | Remote Settings

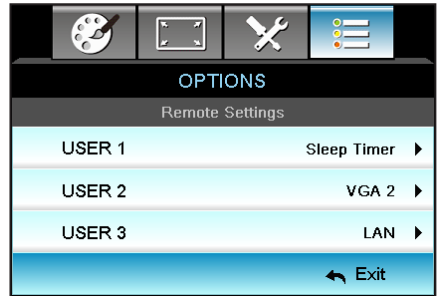

USER 1

The default value is Sleep Timer.



Press ► into the next menu and then use ◀ or ▶ to select "VGA2", "LAN", "Brightness", "Contrast" or "Sleep Timer" item.

USER 2

The default value is VGA2.

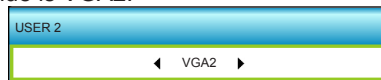

Press ► into the next menu and then use ◀ or ▶ to select "VGA2", "LAN", "Brightness", "Contrast" or "Sleep Timer" item.

USER 3

The default value is LAN.



Press ► into the next menu and then use ◀ or ▶ to select "VGA2", "LAN", "Brightness", "Contrast" or "Sleep Timer" item.

OPTIONS | Advanced



Direct Power On

Choose “On” to activate Direct Power mode. The projector will automatically power on when AC power is supplied, without pressing the “” key on the projector Keypad or on the remote control.

Auto Power Off (min)

Sets the countdown timer interval. The countdown timer will start, when there is no signal being sent to the projector. The projector will automatically power off when the countdown has finished (in minutes).

Sleep Timer (min)

Sets the countdown timer interval. The countdown timer will start, with or without a signal being sent to the projector. The projector will automatically power off when the countdown has finished (in minutes).

Quick Resume

- ▶ On: If the projector is accidentally turned off, this feature allows the projector to be instantly powered on again, if selected within a period of 100 seconds.
- ▶ Off: The fan will start cooling the system after 10 seconds when user turns off the projector.

Power Mode (Standby)

- ▶ Eco.: Choose “Eco.” to save power dissipation further < 0.5W.
- ▶ Active: Without Signal Power On enable, choose “Active” to return to network standby, the VGA out port will be enabled and power consumption will be <6.0 W.

Exit

Choose “Exit” to exit the menu.



- ❖ The value of sleep timer will be reset to zero after the projector power off.
- ❖ The projector will automatically power on when the countdown has finished. The default setting is 20 minutes.

OPTIONS | Optional Filter Settings

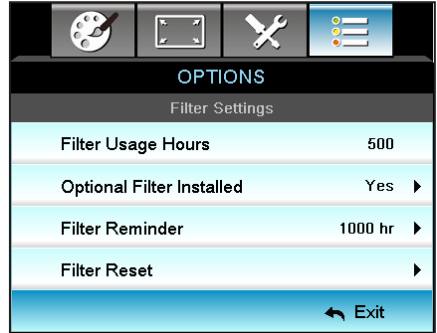

- ❖ “Filter Usage Hours / Filter Reminder / Filter Reset” will only appear when “Optional Filter Installed” is “Yes”.

Filter Usage Hours

Display the filter time.

Optional Filter Installed

- ▶ Yes: Display warning message after 500 hours of use.
- ▶ No: Turn off warning message.

Filter Reminder

Choose this function to show or hide the warning message when the changing filter message is displayed. (Factory default setting: 500 hours)

Filter Reset

Reset the dust filter counter after replacing or cleaning the dust filter.

Exit

Choose “Exit” to exit the menu.

Troubleshooting

If you experience a problem with your projector, please refer to the following information. If a problem persists, please contact your local reseller or service center.

Image Problems

No image appears on-screen

- ▶ Ensure all the cables and power connections are correctly and securely connected as described in the “Installation” section.
- ▶ Ensure the pins of connectors are not crooked or broken.
- ▶ Check if the projection lamp has been securely installed. Please refer to the “Replacing the Lamp” section.
- ▶ Make sure you have removed the lens cap and the projector is switched on.
- ▶ Ensure that the “AV Mute” feature is not turned on.

Image is out of focus

- ▶ Make sure the Lens cap is removed.
- ▶ Adjust the Focus Ring on the projector lens.
- ▶ Make sure the projection screen is between the required distance from the projector. (refer to pages 20-21)

The image is stretched when displaying 16:9 DVD title

- ▶ When you play anamorphic DVD or 16:9 DVD, the projector will show the best image in 16: 9 format on projector side.
- ▶ If you play the LBX format DVD title, please change the format as LBX in projector OSD.
- ▶ If you play 4:3 format DVD title, please change the format as 4:3 in projector OSD.
- ▶ If the image is still stretched, you will also need to adjust the aspect ratio by referring to the following:
- ▶ Please setup the display format as 16:9 (wide) aspect ratio type on your DVD player.

Image is too small or too large

- ▶ Adjust the zoom lever on the top of the projector.
- ▶ Move the projector closer to or further from the screen.
- ▶ Press “Menu” on the projector panel, go to “Display-->Format”. Try the different settings.

Image has slanted sides:

- ▶ If possible, reposition the projector so that it is centered on the screen and below the bottom of the screen.
- ▶ Use “Display-->V Keystone” from the OSD to make an adjustment.

Image is reversed

- ▶ Select “Setup-->Projection” from the OSD and adjust the projection direction.

Blurry double image

- ▶ Press “3D Format” button and switch to “Off” to avoid normal 2D image is blurry double image.

Two images, side-by-side format

- ▶ Press “3D Format” button and switch to “SBS” for input signal is HDMI 1.3 2D 1080i side-by-side.

Image does not display in 3D

- ▶ Check if the battery of 3D glasses is drained.
- ▶ Check if the 3D glasses is turned on.
- ▶ When the input signal is HDMI 1.3 2D (1080i side-by-side half), press “3D Format” button and switch to “SBS”.

Other Problems

The projector stops responding to all controls

- ▶ If possible, turn off the projector, then unplug the power cord and wait at least 20 seconds before reconnecting power.

Lamp burns out or makes a popping sound

















- ▶ When the lamp reaches its end of life, it will burn out and may make a loud popping sound. If this happens, the projector will not turn on until the lamp module has been replaced. To replace the lamp, follow the procedures in the “Replacing the Lamp” section.

Remote Control Problems



If the remote control does not work

- ▶ Check the operating angle of the remote control is within $\pm 15^\circ$ both horizontally and vertically of one of the IR receivers on the projector.
- ▶ Make sure there are not any obstructions between the remote control and the projector. Move to within 6 m (20 ft) of the projector.
- ▶ Make sure batteries are inserted correctly.
- ▶ Replace batteries if they are exhausted.

LED Lighting Messages

Message	 Power LED	 Temp-LED	 Lamp-LED
	(Red/Green/Blue)	(Red)	(Red)
Standby state (Input power cord)	Red		
Power on (Warm- ing)	Flashing Green/Blue		
Lamp lighting	Green/Blue		
Power off (Cooling)	Flashing Green/Blue. Red (cooling fan has turned off)		
Quick Resume (100 secs)	Flashing Green/Blue		
Error (Over temp.)	Flashing Red		
Error (Fan failure)	Flashing Red	Flashing	
Error (Lamp failure)	Flashing Red		



❖ Steady light → 
No light → 

On Screen Messages

❖ Power off:

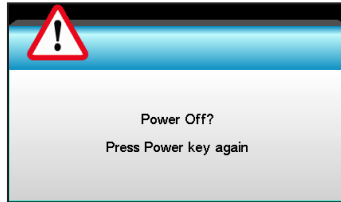

❖ Lamp warning:

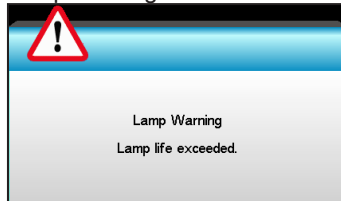

❖ Temperature warning:



❖ Fan failed:

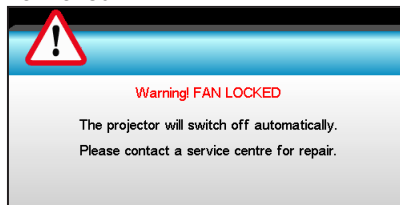

❖ Out of display range:

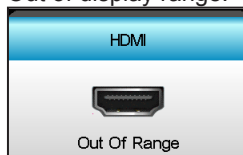

Replacing the Lamp

The projector automatically detects the lamp life. When the lamp life is nearing the end of use, you will receive a warning message.

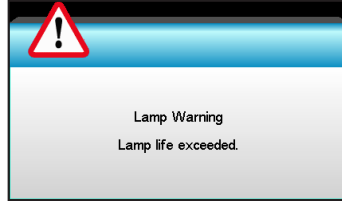

When you see this message, please contact your local reseller or service center to change the lamp as soon as possible. Make sure the projector has been cooled down for at least 30 minutes before changing the lamp.

CAUTION! HIGH TEMPERATURE COOL FOR 30 MINUTES. HIGH PRESSURE LAMP MAY EXPLODE IF IMPROPERLY HANDED. REFER TO LAMP REPLACEMENT INSTRUCTIONS. DISCONNECT POWER BEFORE CHANGING LAMP.

ATTENTION:
A HAUTES TEMPERATURES REFROIDISSEZ PENDANT 30 MINUTES. Les lampes à haute pression peuvent exploser si elles sont mal utilisées. Confier l'entretien à une personne qualifiée. COUPER LE COURANT AVANT DE REMPLACER LES LAMPES.



Warning: If ceiling mounted, please use caution when opening the lamp access panel. It is recommended to wear safety glasses if changing the bulb when ceiling mounted. "Caution must be used to prevent any loose parts from falling out of projector."



Warning: Lamp compartment is hot! Allow it to cool down before changing lamp!



Warning: To reduce the risk of personal injury, do not drop the lamp module or touch the lamp bulb. The bulb may shatter and cause injury if it is dropped.

Appendices

NOTE

- ❖ The screw on the lamp cover and the lamp cannot be removed.
- ❖ The projector cannot be turned on if the lamp cover has not been placed back on the projector.
- ❖ Do not touch the glass area of the lamp. Hand oil can cause the lamp to shatter. Use a dry cloth to clean the lamp module if it was accidentally touched.

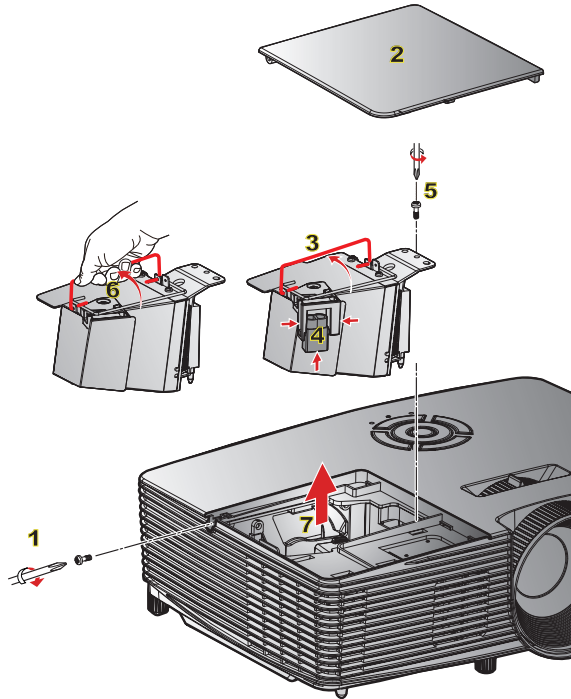

Lamp Replacement Procedure:

1. Switch off the power to the projector by pressing the “**⏻**” button on the remote control or on the Keypad of the projector.
 2. Allow the projector to cool down for at least 30 minutes.
 3. Disconnect the power cord.
 4. Unscrew the one screw on the cover. **1**
 5. Push up and remove the cover. **2**
 6. Lift up the lamp handle. **3**
 7. Press on the both sides then lift up and remove the lamp cord. **4**
 8. Unscrew the one screw on the lamp module. **5**
 9. Lift up the lamp handle **6** and remove the lamp module slowly and carefully. **7**
- To replace the lamp module, reverse the previous steps.
10. Turn on the projector and reset the lamp timer.

Lamp Reset: (i) Press “Menu” → (ii) Select “OPTIONS” → (iii) Select “Lamp Settings” → (iv) Select “Lamp Reset” → (v) Select “Yes”.

Installing and Cleaning the Dust Filter



- ❖ Dust filters are only required/supplied in selected regions with excessive dust.

Installing the Dust Filter

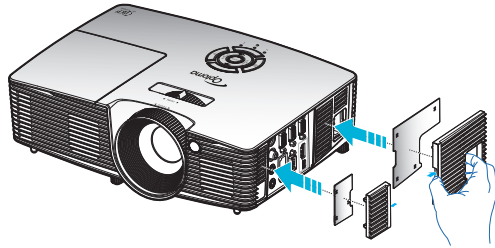

Cleaning the Dust Filter

We recommend cleaning the dust filter every three months; clean it more often if the projector is used in a dusty environment.

Procedure:

1. Switch off the power to the projector by pressing the “**⏻**” button on the remote control or on the Keypad of the projector.
2. Disconnect the power cord.
3. Remove the dust filter slowly and carefully.
4. Clean or replace the dust filter.
5. To install the dust filter, reverse the previous steps.

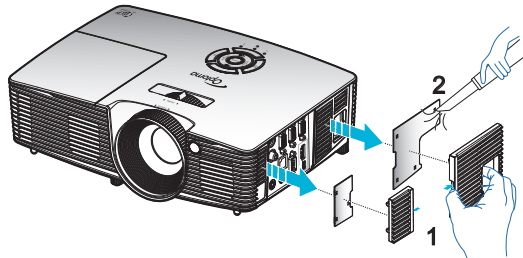

Compatibility Modes

HDMI Compatibility

Digital		
B0/Established timing	B0/Standard timing	B0/Detail timing:
720 x 400 @ 70Hz 640 x 480 @ 60Hz 640 x 480 @ 67Hz 640 x 480 @ 72Hz 640 x 480 @ 75Hz 800 x 600 @ 56Hz 800 x 600 @ 60Hz 800 x 600 @ 72Hz 800 x 600 @ 75Hz 832 x 624 @ 75Hz 1024 x 768 @ 60Hz 1024 x 768 @ 70Hz 1024 x 768 @ 75Hz 1280 x 1024 @ 75Hz 1152 x 870 @ 75Hz	XGA / WXGA 1440 x 900 @ 60Hz 1024 x 768 @ 120Hz 1280 x 800 @ 60Hz 1280 x 1024 @ 60Hz 1680 x 1050 @ 60Hz 1280 x 720 @ 60Hz 1280 x 720 @ 120Hz 1600 x 1200 @ 60Hz	Native timing: XGA: 1024 x 768 @ 60Hz WXGA: 1280 x 800 @ 60Hz; 1280 x 720 @ 60Hz 1080P: 1920 x 1080 @ 60Hz
B1/Video mode	B1/Detail timing:	
640 x 480p @ 60Hz 720 x 480p @ 60Hz 1280 x 720p @ 60Hz 1920 x 1080i @ 60Hz 720(1440) x 480i @ 60Hz 1920 x 1080p @ 60Hz 720 x 576p @ 50Hz 1280 x 720p @ 50Hz 1920 x 1080i @ 50Hz 720(1440) x 576i @ 50Hz 1920 x 1080p @ 50Hz 1920 x 1080p @ 24Hz 1920 x 1080p @ 30Hz	720 x 480p @ 60Hz 1280 x 720p @ 60Hz 1366 x 768 @ 60Hz 1920 x 1080i @ 50Hz 1920 x 1080p @ 60Hz	

3D Input Video Compatibility

Input resolution	Input timing		
HDMI 1.4b 3D Input	1280 x 720p @ 50Hz	Top-and-Bottom	
	1280 x 720p @ 60Hz	Top-and-Bottom	
	1280 x 720p @ 50Hz	Frame packing	
	1280 x 720p @ 60Hz	Frame packing	
	1920 x 1080i @ 50 Hz	Side-by-Side (Half)	
	1920 x 1080i @ 60 Hz	Side-by-Side (Half)	
	1920 x 1080p @ 24 Hz	Top-and-Bottom	
	1920 x 1080p @ 24 Hz	Frame packing	
HDMI 1.4b 3D Content	1920 x 1080i @ 50Hz	Side-by-Side (Half)	While 3D Format is "SBS"
	1920 x 1080i @ 60Hz		
	1280 x 720p @ 50Hz		
	1280 x 720p @ 60Hz		
	800 x 600 @ 60Hz		
	1024 x 768 @ 60Hz		
	1280 x 800 @ 60Hz		
	1920 x 1080i @ 50Hz	Top-and-Bottom	While 3D Format is "Top and Bottom"
	1920 x 1080i @ 60Hz		
	1280 x 720p @ 50Hz		
	1280 x 720p @ 60Hz		
	800 x 600 @ 60Hz		
	1024 x 768 @ 60Hz		
	1280 x 800 @ 60Hz		
	480i	HQFS	While 3D Format is "Frame sequential"

RS232 Commands and Protocol Function List

RS232 Pin Assignments



- ❖ RS232 shell is grounded.

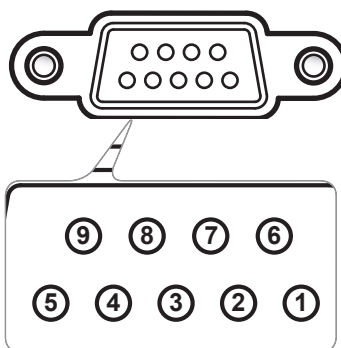

Pin no.	Spec. (from projector side)
1	N/A
2	RXD
3	TXD
4	N/A
5	GND
6	N/A
7	N/A
8	N/A
9	N/A

Appendices

RS232 Protocol Function List



1. There is a <CR> after all ASCII commands.
2. 0D is the HEX code for <CR> in ASCII code.

Baud Rate : 9600
 Data Bits: 8
 Parity: None
 Stop Bits: 1
 Flow Control : None
 UART16550 FIFO: Disable
 Projector Return (Pass): P
 Projector Return (Fail): F

XX=01-99, projector's ID,
 XX=00 is for all projectors

SEND to projector

232 ASCH Code	HEX Code	Function	Description
~XX00 1	7E 30 30 30 20 31 0D	Power ON	
~XX00 0	7E 30 30 30 20 30 0D	Power OFF	(0/2 for backward compatible)
~XX00 1~nnnn	7E 30 30 30 20 31 20 a 0D	Power ON with Password	~nnnn = ~0000 (a=7E 30 30 30) ~9999 (a=7E 39 39 39 39)
~XX01 1	7E 30 30 31 20 31 0D	Resync	
~XX02 1	7E 30 30 32 20 31 0D	AV Mute	On
~XX02 0	7E 30 30 32 20 30 0D		Off (0/2 for backward compatible)
~XX03 1	7E 30 30 33 20 31 0D	Mute	On
~XX03 0	7E 30 30 33 20 30 0D		Off (0/2 for backward compatible)
~XX04 1	7E 30 30 34 20 31 0D	Freeze	
~XX04 0	7E 30 30 34 20 30 0D	Unfreeze	(0/2 for backward compatible)
~XX05 1	7E 30 30 35 20 31 0D	Zoom Plus	
~XX06 1	7E 30 30 36 20 31 0D	Zoom Minus	
~XX12 1	7E 30 31 32 20 31 0D	Direct Source Commands	HDMI
~XX12 5	7E 30 31 32 20 35 0D		VGA1
~XX12 6	7E 30 31 32 20 36 0D		VGA 2
~XX12 8	7E 30 31 32 20 38 0D		VGA1 Component
~XX12 10	7E 30 31 32 20 31 30 0D		Video
~XX12 13	7E 30 31 32 20 31 33 0D		VGA 2 Component
~XX20 1	7E 30 32 30 20 31 0D	Display Mode	Presentation
~XX20 2	7E 30 32 30 20 32 0D		Bright
~XX20 3	7E 30 32 30 20 33 0D		Movie
~XX20 4	7E 30 32 30 20 34 0D		sRGB
~XX20 5	7E 30 32 30 20 35 0D		User
~XX20 7	7E 30 32 30 20 37 0D		Blackboard
~XX20 9	7E 30 32 30 20 39 0D		3D
~XX20 13	7E 30 32 30 21 33 0D		DICOM SIM.
~XX21 n	7E 30 32 31 20 a 0D	Brightness	n = -50 (a=2D 35 30) ~ 50 (a=35 30)
~XX22 n	7E 30 32 32 20 a 0D	Contrast	n = -50 (a=2D 35 30) ~ 50 (a=35 30)
~XX23 n	7E 30 32 33 20 a 0D	Sharpness	n = 1 (a=31) ~ 15 (a=31 35)
~XX24 n	7E 30 32 34 20 a 0D	Color Settings/White	Red n = -50 (a=2D 35 30) ~ 50 (a=35 30)
~XX25 n	7E 30 32 35 20 a 0D		Green n = -50 (a=2D 35 30) ~ 50 (a=35 30)
~XX26 n	7E 30 32 36 20 a 0D		Blue n = -50 (a=2D 35 30) ~ 50 (a=35 30)
~XX33 1	7E 30 33 33 20 31 0D		Reset
~XX34 n	7E 30 33 34 20 a 0D	BrilliantColor™	n = 1 (a=30) ~ 10 (a=31 30)
~XX35 1	7E 30 33 35 20 31 0D	Gamma	Film
~XX35 2	7E 30 33 35 20 32 0D		Video
~XX35 3	7E 30 33 35 20 33 0D		Graphics
~XX35 4	7E 30 33 35 20 34 0D		Standard
~XX36 1	7E 30 33 36 20 31 0D	Color Temp.	Warm
~XX36 2	7E 30 33 36 20 32 0D		Medium
~XX36 3	7E 30 33 36 20 33 0D		Cold
~XX37 1	7E 30 33 37 20 31 0D	Color Space	Auto
~XX37 2	7E 30 33 37 20 32 0D		RGB:RGB(0-255)
~XX37 3	7E 30 33 37 20 33 0D		YUV
~XX37 4	7E 30 33 37 20 34 0D		RGB(16-235)
~XX73 n	7E 30 37 33 20 a 0D	Signal	Frequency n = -5 (a=2D 35) ~ 5 (a=35) By signal
~XX91 n	7E 30 39 31 20 a 0D	Automatic	n = 0 disable; n = 1 enable
~XX74 n	7E 30 37 34 20 a 0D	Phase	n = 0 (a=30) ~ 31 (a=33 31) By signal
~XX75 n	7E 30 37 35 20 a 0D	H. Position	n = -5 (a=2D 35) ~ 5 (a=35) By timing
~XX76 n	7E 30 37 36 20 a 0D	V. Position	n = -5 (a=2D 35) ~ 5 (a=35) By timing
~XX45 n	7E 30 34 34 20 a 0D	Color (Saturation)	n = -50 (a=2D 35 30) ~ 50 (a=35 30)
~XX44 n	7E 30 34 35 20 a 0D	Tint	n = -50 (a=2D 35 30) ~ 50 (a=35 30)

Appendices

-XX60 1	7E 30 30 36 30 20 31 0D	Format	4:3
-XX60 2	7E 30 30 36 30 20 32 0D		16:9
-XX60 3	7E 30 30 36 30 20 33 0D		16:10(WXGA)
-XX60 5	7E 30 30 36 30 20 35 0D		LBX(WXGA)
-XX60 6	7E 30 30 36 30 20 36 0D		Native
-XX60 7	7E 30 30 36 30 20 37 0D		Auto
-XX61 n	7E 30 30 36 31 20 a 0D	Edge mask	n = 0 (a=30) ~ 10 (a=31 30)
-XX62 n	7E 30 30 36 32 20 a 0D	Zoom	n = -5 (a=2D 35) ~ 25 (a=32 35)
-XX63 n	7E 30 30 36 33 20 a 0D	H Image Shift	n = -100 (a=2D 31 30 30) ~ 100 (a=31 30 30)
-XX64 n	7E 30 30 36 34 20 a 0D	V Image Shift	n = -100 (a=2D 31 30 30) ~ 100 (a=31 30 30)
-XX66 n	7E 30 30 36 36 20 a 0D	V Keystone	n = -40 (a=2D 34 30) ~ 40 (a=34 30)
-XX230 0	7E 30 30 32 33 30 20 30 0D	3D Mode	OFF
-XX230 1	7E 30 30 32 33 30 20 31 0D	3D Mode	DLP-Link
-XX230 3	7E 30 30 32 33 30 20 31 0D	3D Mode	VESA 3D
-XX400 0	7E 30 30 34 30 20 30 0D	3D->2D	3D
-XX400 1	7E 30 30 34 30 20 31 0D		L
-XX400 2	7E 30 30 34 30 20 32 0D		R
-XX405 0	7E 30 30 34 30 35 20 30 0D	3D Format	Auto
-XX405 1	7E 30 30 34 30 35 20 31 0D		SBS
-XX405 2	7E 30 30 34 30 35 20 32 0D		Top and Bottom
-XX405 3	7E 30 30 34 30 35 20 33 0D		Frame sequential
-XX231 0	7E 30 30 32 33 31 20 30 0D	3D Sync Invert	On
-XX231 1	7E 30 30 32 33 31 20 31 0D	3D Sync Invert	Off
-XX70 1	7E 30 30 37 30 20 31 0D	Language	English
-XX70 2	7E 30 30 37 30 20 32 0D		German
-XX70 3	7E 30 30 37 30 20 33 0D		French
-XX70 4	7E 30 30 37 30 20 34 0D		Italian
-XX70 5	7E 30 30 37 30 20 35 0D		Spanish
-XX70 6	7E 30 30 37 30 20 36 0D		Portuguese
-XX70 7	7E 30 30 37 30 20 37 0D		Polish
-XX70 8	7E 30 30 37 30 20 38 0D		Dutch
-XX70 9	7E 30 30 37 30 20 39 0D		Swedish
-XX70 10	7E 30 30 37 30 20 31 30 0D		Norwegian/Danish
-XX70 11	7E 30 30 37 30 20 31 31 0D		Finnish
-XX70 12	7E 30 30 37 30 20 31 32 0D		Greek
-XX70 13	7E 30 30 37 30 20 31 33 0D		Traditional Chinese
-XX70 14	7E 30 30 37 30 20 31 34 0D		Simplified Chinese
-XX70 15	7E 30 30 37 30 20 31 35 0D		Japanese
-XX70 16	7E 30 30 37 30 20 31 36 0D		Korean
-XX70 17	7E 30 30 37 30 20 31 37 0D		Russian
-XX70 18	7E 30 30 37 30 20 31 38 0D		Hungarian
-XX70 19	7E 30 30 37 30 20 31 39 0D		Czechoslovak
-XX70 20	7E 30 30 37 30 20 32 30 0D		Arabic
-XX70 21	7E 30 30 37 30 20 32 31 0D		Thai
-XX70 22	7E 30 30 37 30 20 32 32 0D		Turkish
-XX70 23	7E 30 30 37 30 20 32 33 0D		Farsi
-XX70 25	7E 30 30 37 30 20 32 33 0D		Vietnamese
-XX70 26	7E 30 30 37 30 20 32 33 0D		Indonesian
-XX70 27	7E 30 30 37 30 20 32 33 0D		Romanian
-XX71 1	7E 30 30 37 31 20 31 0D	Projection	Front-Desktop
-XX71 2	7E 30 30 37 31 20 32 0D		Rear-Desktop
-XX71 3	7E 30 30 37 31 20 33 0D		Front-Ceiling
-XX71 4	7E 30 30 37 31 20 34 0D		Rear-Ceiling
-XX72 1	7E 30 30 37 32 20 31 0D	Menu Location	Top Left
-XX72 2	7E 30 30 37 32 20 32 0D		Top Right
-XX72 3	7E 30 30 37 32 20 33 0D		Centre
-XX72 4	7E 30 30 37 32 20 34 0D		Bottom Left
-XX72 5	7E 30 30 37 32 20 35 0D		Bottom Right
(WXGA only)			
-XX90 1	7E 30 30 39 31 20 31 0D	Screen Type	16:10
-XX90 0	7E 30 30 39 31 20 30 0D		16:9
-XX77 n	7E 30 30 37 37 20 aabbcc 0D	Security	Security Timer Month/Day/Hour n = mm/dd/hh mm= 00 (aa=30 30) ~ 12 (aa=31 32) dd = 00 (bb=30 30) ~ 30 (bb=33 30) hh= 00 (cc=30 30) ~ 24 (cc=32 34)
-XX78 1	7E 30 30 37 38 20 31 0D		Security Settings
-XX78 0 ~nmm	7E 30 30 37 38 20 32 a 0D		Enable Disable(0/2 for backward compatible) -nmm = -0000 (a=7E 30 30 30 30) ~9999 (a=7E 39 39 39 39)
-XX79 n	7E 30 30 37 39 20 a 0D	Projector ID	n = 00 (a=30 30) ~ 99 (a=39 39)
-XX80 1	7E 30 30 38 30 20 31 0D	Mute	On
-XX80 0	7E 30 30 38 30 20 30 0D		Off (0/2 for backward compatible)
-XX310 0	7E 30 33 31 30 20 30 0D	Internal Speaker	Off
-XX310 1	7E 30 33 31 30 20 31 0D		On
-XX81 n	7E 30 30 38 31 20 a 0D	Volume (Audio)	n = 0 (a=30) ~ 10 (a=31 30)
-XX82 1	7E 30 30 38 32 20 31 0D	Logo	Default
-XX82 3	7E 30 30 38 32 20 33 0D		Neutral

Appendices

-XX88 0	7E 30 30 38 28 20 30 0D	Closed Captioning	Off
-XX88 1	7E 30 30 38 28 20 31 0D		cc1
-XX88 2	7E 30 30 38 28 20 32 0D		cc2
-XX89 0	7E 30 30 38 29 20 30 0D	Audio Input	Default
-XX89 1	7E 30 30 38 29 20 31 0D		Audio1
-XX89 3	7E 30 30 38 29 20 33 0D		Audio2(SVGA2, SVGA3, XGA1, XGA2, WXGA)
-XX454 0	7E 30 30 34 35 34 20 30 0D	Crestron	Off
-XX454 1	7E 30 30 34 35 34 20 31 0D		On
-XX455 0	7E 30 30 34 35 35 20 30 0D	Extron	Off
-XX455 1	7E 30 30 34 35 35 20 31 0D		On
-XX456 0	7E 30 30 34 35 36 20 30 0D	PJLink	Off
-XX456 1	7E 30 30 34 35 36 20 31 0D		On
-XX457 0	7E 30 30 34 35 37 20 30 0D	AMX Device Discovery	Off
-XX457 1	7E 30 30 34 35 37 20 31 0D		On
-XX458 0	7E 30 30 34 35 38 20 30 0D	Telnet	Off
-XX458 1	7E 30 30 34 35 38 20 31 0D		On
-XX459 0	7E 30 30 34 35 38 20 30 0D	HTTP	Off
-XX459 1	7E 30 30 34 35 38 20 31 0D		On
-XX100 1	7E 30 30 31 30 20 20 31 0D	Source Lock	On
-XX100 0	7E 30 30 31 30 20 20 30 0D		Off (0/2 for backward compatible)
-XX101 1	7E 30 30 31 30 20 31 0D	High Altitude	On
-XX101 0	7E 30 30 31 30 20 30 0D		Off (0/2 for backward compatible)
-XX102 1	7E 30 30 31 30 20 31 0D	Information Hide	On
-XX102 0	7E 30 30 31 30 20 30 0D		Off (0/2 for backward compatible)
-XX103 1	7E 30 30 31 30 33 20 31 0D	Keypad Lock	On
-XX103 0	7E 30 30 31 30 33 20 30 0D		Off (0/2 for backward compatible)
-XX195 0	7E 30 30 31 39 35 20 30 0D	Test Pattern	None
-XX195 1	7E 30 30 31 39 35 20 31 0D		Grid
-XX195 2	7E 30 30 31 39 35 20 32 0D		White Pattern
-XX11 0	7E 30 30 31 20 30 0D	IR Function	Off
-XX11 1	7E 30 30 31 20 31 0D		On
-XX11 2	7E 30 30 31 20 32 0D		Front
-XX11 3	7E 30 30 31 20 33 0D		Top
-XX104 1	7E 30 30 31 30 34 20 31 0D	Background Color	Blue
-XX104 2	7E 30 30 31 30 34 20 32 0D		Black
-XX104 3	7E 30 30 31 30 34 20 33 0D		Red
-XX104 4	7E 30 30 31 30 34 20 34 0D		Green
-XX104 5	7E 30 30 31 30 34 20 35 0D		White
-XX105 1	7E 30 30 31 30 35 20 31 0D	Advanced	Direct Power On On
-XX105 0	7E 30 30 31 30 35 20 30 0D		Off (0/2 for backward compatible)
-XX106 n	7E 30 30 31 30 36 20 a 0D		Auto Power Off (min) n = 0 (a=30) ~ 180 (a=31 38 30)
-XX107 n	7E 30 30 31 30 37 20 a 0D		Sleep Timer (min) n = 0 (a=30) ~ 990 (a=39 39 39)
-XX115 1	7E 30 30 31 31 35 20 31 0D		Quick Resume On
-XX115 0	7E 30 30 31 31 35 20 30 0D		Off (0/2 for backward compatible)
-XX114 1	7E 30 30 31 31 34 20 31 0D		Power Mode(Standby) Eco (<=0.5W)
-XX114 0	7E 30 30 31 31 34 20 30 0D		Active (0/2 for backward compatible)
-XX109 1	7E 30 30 31 30 39 20 31 0D		Lamp Reminder On
-XX109 0	7E 30 30 31 30 39 20 30 0D		Off (0/2 for backward compatible)
-XX110 1	7E 30 30 31 31 30 20 31 0D		Brightness Mode Bright
-XX110 2	7E 30 30 31 31 30 20 32 0D		Eco
-XX110 3	7E 30 30 31 31 30 20 33 0D		Eco
-XX110 4	7E 30 30 31 31 30 20 34 0D		Dynamic
-XX111 1	7E 30 30 31 31 31 20 31 0D		Lamp Reset Yes
-XX111 0	7E 30 30 31 31 31 20 30 0D		No (0/2 for backward compatible)
-XX322 0	7E 30 30 33 32 32 20 30 0D	Filter Reminder	Off
-XX322 1	7E 30 30 33 32 32 20 31 0D		300 hr
-XX322 2	7E 30 30 33 32 32 20 32 0D		500 hr
-XX322 3	7E 30 30 33 32 32 20 33 0D		800 hr
-XX322 4	7E 30 30 33 32 32 20 34 0D		1000 hr
-XX323 1	7E 30 30 33 32 33 20 31 0D	Filter Reset	Yes
-XX323 0	7E 30 30 33 32 33 20 30 0D		No
-XX112 1	7E 30 30 31 31 32 20 31 0D	Reset	Yes
-XX99 1	7E 30 30 39 39 20 31 0D	RS232 Alert Reset	Reset System Alert
-XX210 n	7E 30 30 32 30 30 20 n 0D	Display message on the OSD	n: 1-30 characters
SEND to emulate Remote			
-XX140 10	7E 30 30 31 34 30 20 31 30 0D		Up
-XX140 11	7E 30 30 31 34 30 20 31 31 0D		Left
-XX140 12	7E 30 30 31 34 30 20 31 32 0D		Enter (for projection MENU)
-XX140 13	7E 30 30 31 34 30 20 31 33 0D		Right
-XX140 14	7E 30 30 31 34 30 20 31 34 0D		Down
-XX140 15	7E 30 30 31 34 30 20 31 35 0D		Keystone +
-XX140 16	7E 30 30 31 34 30 20 31 36 0D		Keystone -
-XX140 17	7E 30 30 31 34 30 20 31 37 0D		Volume -
-XX140 18	7E 30 30 31 34 30 20 31 38 0D		Volume +
-XX140 19	7E 30 30 31 34 30 20 31 39 0D		Brightness
-XX140 20	7E 30 30 31 34 30 20 32 30 0D		Menu
-XX140 21	7E 30 30 31 34 30 20 32 31 0D		Zoom
-XX140 28	7E 30 30 31 34 30 20 32 38 0D		Contrast
-XX140 47	7E 30 30 31 34 30 20 34 37 0D		Source

Appendices

SEND from projector automatically

232 ASCII Code	HEX Code	Function	Projector Return	Description
		System status	INFO	n : 0/1/2/3/4/5/6/7/8 = Standby/Warming/Cooling/Out of Range/Lamp fail/Fan Lock/Over Temperature/Lamp Hours Running Out

READ from projector

232 ASCII Code	HEX Code	Function	Projector Return	Description
~XX121 1	7E 30 30 31 32 31 20 31 0D	Input Source Commands	OKn	n : 0/1/2/3/5 = None/VGA1/VGA2/Video/HDMI
~XX122 1	7E 30 30 31 32 32 20 31 0D	Software Version	OKdddd	dddd: FW version
~XX123 1	7E 30 30 31 32 33 20 31 0D	Display Mode	OKn	n : 0/1/2/3/4/5/6/7 None/Presentation/Bright/Movie/sRGB/User/Blackboard/3D
~XX124 1	7E 30 30 31 32 34 20 31 0D	Power State	OKn	n : 0/1 = Off/On
~XX125 1	7E 30 30 31 32 35 20 31 0D	Brightness	OKn	n = -50 ~ 50
~XX126 1	7E 30 30 31 32 36 20 31 0D	Contrast	OKn	n = -50 ~ 50
~XX127 1	7E 30 30 31 32 37 20 31 0D	Aspect Ratio	OKn	n : 0/1/2/3 = 4:3/16:9/Native/AUTO (XGA) n : 0/1/2/3/4 = 4:3/16:9 or 16:10/LBX/Naive/AUTO (WXGA) *16:9 or 16:10 depend on Screen Type setting
~XX128 1	7E 30 30 31 32 38 20 31 0D	Color Temperature	OKn	n : 0/1/2 = Warm/Medium/Cold
~XX129 1	7E 30 30 31 32 39 20 31 0D	Projection Mode	OKn	n : 0/1/2/3 = Front-Desktop/Rear-Desktop/Front-Ceiling/Rear-Ceiling
~XX150 1	7E 30 30 31 35 30 20 31 0D	Information	OKabbbccddddd	a : 0/1 = Off/On bbbb: Lamp Hour cc: source 00/01/02/03/05/= None/VGA1/VGA2/Video/HDMI dddd: FW version e : Display mode 0/1/2/3/4/5/6/7/8 None/Presentation/Bright/Movie/sRGB/User/Blackboard/DICOM SIM./3D
~XX151 1	7E 30 30 31 35 31 20 31 0D	Model name	OKn	n:1:2= XGA/ WXGA
~XX108 1	7E 30 30 31 30 38 20 31 0D	Lamp Hours	OKbbbb	bbbb: Lamp Hour
~XX108 2	7E 30 30 31 30 38 20 31 0D	Cumulative Lamp Hours	OKbbbbbb	bbbbbb: (5 digits) Total Lamp Hours
~XX321 1	7E 30 30 33 32 31 20 31 0D	Filter Usage Hours	OKbbbb	bbbb: Filter Usage Hours

Ceiling Mount Installation

1. To prevent damage to your projector, please use the Optoma ceiling mount.
2. If you wish to use a third party ceiling mount kit, please ensure the screws used to attach a mount to the projector meet the following specifications:

- ▶ Screw type: M4*3
- ▶ Minimum screw length: 10mm



❖ Please note that damage resulting from incorrect installation will void the warranty.



⚠ Warning:

1. If you buy a ceiling mount from another company, please be sure to use the correct screw size. Screw size will vary depending on the thickness of the mounting plate.
2. Be sure to keep at least 10 cm gap between the ceiling and the bottom of the projector.
3. Avoid installing the projector near a heat source.

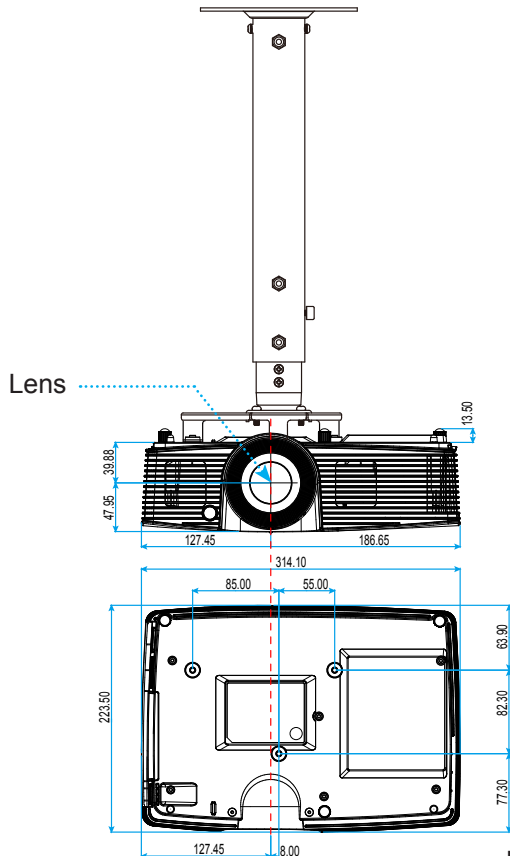



Unit: mm

Optoma Global Offices

For service or support please contact your local office.



USA

3178 Laurelview Ct.
Fremont, CA 94538, USA
www.optomausa.com

 888-289-6786
 510-897-8601
 services@optoma.com



Canada

3178 Laurelview Ct.
Fremont, CA 94538, USA
www.optomausa.com

 888-289-6786
 510-897-8601
 services@optoma.com

Latin America

3178 Laurelview Ct.
Fremont, CA 94538, USA
www.optomausa.com

 888-289-6786
 510-897-8601
 services@optoma.com



Europe

42 Caxton Way, The Watford Business Park
Watford, Hertfordshire,
WD18 8QZ, UK
www.optoma.eu
Service Tel : +44 (0)1923 691865

 +44 (0) 1923 691 800
 +44 (0) 1923 691 888
 service@tsc-europe.com



Benelux BV

Randstad 22-123
1316 BW Almere
The Netherlands
www.optoma.nl

 +31 (0) 36 820 0253
 +31 (0) 36 548 9052



France

Bâtiment E
81-83 avenue Edouard Vaillant
92100 Boulogne Billancourt, France
savoptoma@optoma.fr

 +33 1 41 46 12 20
 +33 1 41 46 94 35
 savoptoma@optoma.fr



Spain

C/ José Hierro,36 Of. 1C
28522 Rivas VaciaMadrid,
Spain

 +34 91 499 06 06
 +34 91 670 08 32

Deutschland

Wiesenstrasse 21 W
D40549 Düsseldorf,
Germany

 +49 (0) 211 506 6670
 +49 (0) 211 506 66799
 info@optoma.de

Scandinavia



Lerpeveien 25
3040 Drammen
Norway

 +47 32 98 89 90
 +47 32 98 89 99
 info@optoma.no

PO.BOX 9515
3038 Drammen
Norway

Korea

WOOMI TECH.CO.,LTD.
4F,Minu Bldg.33-14, Kangnam-Ku,
seoul,135-815, KOREA

 +82+2+34430004
 +82+2+34430005



Japan

東京都足立区綾瀬3-25-18
株式会社オーエス
コンタクトセンター:0120-380-495

 info@os-worldwide.com
www.os-worldwide.com



Taiwan

12F., No.213, Sec. 3, Beixin Rd.,
Xindian Dist., New Taipei City 231,
Taiwan, R.O.C.
www.optoma.com.tw

 +886-2-8911-8600
 +886-2-8911-6550
 services@optoma.com.tw
asia.optoma.com



Hong Kong

Unit A, 27/F Dragon Centre,
79 Wing Hong Street,
Cheung Sha Wan,
Kowloon, Hong Kong

 +852-2396-8968
 +852-2370-1222
www.optoma.com.hk

China

5F, No. 1205, Kaixuan Rd.,
Changning District
Shanghai, 200052, China

 +86-21-62947376
 +86-21-62947375
www.optoma.com.cn

Regulation & Safety Notices

This appendix lists the general notices of your projector.

FCC Notice

This device has been tested and found to comply with the limits for a Class B digital device pursuant to Part 15 of the FCC rules. These limits are designed to provide reasonable protection against harmful interference in a residential installation. This device generates, uses and can radiate radio frequency energy and, if not installed and used in accordance with the instructions, may cause harmful interference to radio communications.

However, there is no guarantee that interference will not occur in a particular installation. If this device does cause harmful interference to radio or television reception, which can be determined by turning the device off and on, the user is encouraged to try to correct the interference by one or more of the following measures:

- ❖ Reorient or relocate the receiving antenna.
- ❖ Increase the separation between the device and receiver.
- ❖ Connect the device into an outlet on a circuit different from that to which the receiver is connected.
- ❖ Consult the dealer or an experienced radio/television technician for help.

Notice: Shielded cables

All connections to other computing devices must be made using shielded cables to maintain compliance with FCC regulations.

Caution

Changes or modifications not expressly approved by the manufacturer could void the user's authority, which is granted by the Federal Communications Commission, to operate this projector.

Operation Conditions

This device complies with Part 15 of the FCC Rules. Operation is subject to the following two conditions:

1. This device may not cause harmful interference and
2. This device must accept any interference received, including interference that may cause undesired operation.

Notice: Canadian users

This Class B digital apparatus complies with Canadian ICES-003.

Remarque à l'intention des utilisateurs canadiens

Cet appareil numérique de la classe B est conforme à la norme NMB-003 du Canada.

Declaration of Conformity for EU countries

- EMC Directive 2004/108/EC (including amendments)
- Low Voltage Directive 2006/95/EC
- R & TTE Directive 1999/5/EC (if product has RF function)



Disposal instructions

Do not throw this electronic device into the trash when discarding. To minimize pollution and ensure utmost protection of the global environment, please recycle it.

