



Table of Contents

Table of Contents	1	SETUP Audio Settings.....	53
Usage Notice	2	SETUP Security.....	55
Safety Information.....	2	SETUP Network.....	57
Precautions.....	3	SETUP Network\LAN Settings.....	58
Eye Safety Warnings.....	5	SETUP Network\Control Settings	60
Product Features	5	SETUP Signal (RGB).....	70
Introduction.....	6	SETUP Signal (Video).....	72
Package Overview	6	SETUP Advanced.....	73
Product Overview.....	7	OPTIONS.....	75
Main Unit.....	7	OPTIONS Lamp Settings.....	79
Control Panel.....	8	OPTIONS Advanced.....	81
Input/Output Connections.....	9	OPTIONS Remote Settings.....	83
Remote Control.....	10	OPTIONS Filter Settings.....	84
Installation	11	Appendices.....	85
Connecting to the Projector.....	11	Troubleshooting.....	85
Connecting a Computer/Notebook	11	Image Problems.....	85
Connecting a Video source.....	12	Other Problems.....	87
Connect to 3D Video Devices	13	Remote Control Problems	87
Using the 3D glasses.....	15	LED Lighting Messages.....	88
Powering On/Off the Projector	16	On Screen Messages	89
Powering On the Projector.....	16	Replacing the Lamp.....	90
Powering Off the Projector.....	17	Installing and Cleaning the	
Warning Indicator.....	18	Dust Filter	92
Adjusting the Projected Image.....	19	Compatibility Modes	93
Adjusting the Projector's Height	19	RS232 Commands and	
Adjusting the Projector's Focus.....	20	Protocol Function List	95
Adjusting Projection Image Size	20	RS232 Pin Assignments.....	95
User Controls.....	23	RS232 Protocol Function List.....	96
Control Panel & Remote Control.....	23	Ceiling Mount Installation.....	104
Control Panel.....	23	Optoma Global Offices	105
Remote Control.....	24	Regulation & Safety Notices	107
On-screen Display Menus.....	27	FCC Notice	107
How to operate	27	Declaration of Conformity for	
Menu Tree.....	28	EU countries	108
IMAGE	35		
IMAGE Advanced	38		
DISPLAY.....	43		
DISPLAY 3D	48		
SETUP.....	50		

Safety Information

	The lightning flash with arrow head within an equilateral triangle is intended to alert the user to the presence of uninsulated "dangerous voltage" within the product's enclosure that may be of sufficient magnitude to constitute a risk of electric shock to persons.
	The exclamation point within an equilateral triangle is intended to alert the user to the presence of important operating and maintenance (servicing) instructions in the literature accompanying the appliance.

WARNING: TO REDUCE THE RISK OF FIRE OR ELECTRIC SHOCK, DO NOT EXPOSE THIS APPLIANCE TO RAIN OR MOISTURE. DANGEROUS HIGH VOLTAGES ARE PRESENT INSIDE THE ENCLOSURE. DO NOT OPEN THE CABINET. REFER SERVICING TO QUALIFIED PERSONNEL ONLY.

Class B emissions limits

This Class B digital apparatus meets all requirements of the Canadian Interference-Causing Equipment Regulations.

Important Safety Instruction

1. Do not block any ventilation openings. To ensure reliable operation of the projector and to protect from over heating, it is recommended to install the projector in a location that does not block ventilation. As an example, do not place the projector on a crowded coffee table, sofa, bed, etc. Do not put the projector in an enclosure such as a book case or a cabinet that restricts air flow.
2. Do not use the projector near water or moisture. To reduce the risk of fire and/or electric shock, do not expose the projector to rain or moisture.
3. Do not install near heat sources such as radiators, heaters, stoves or any other apparatus such as amplifiers that emits heat.
4. Clean only with dry cloth.
5. Only use attachments/accessories specified by the manufacturer.
6. Do not use the unit if it has been physically damaged or abused. Physical damage/abuse would be (but not limited to):
 - Unit has been dropped.
 - Power supply cord or plug has been damaged.
 - Liquid has been spilled on to the projector.
 - Projector has been exposed to rain or moisture.
 - Something has fallen in the projector or something is loose inside.Do not attempt to service the unit yourself. Opening or removing covers may expose you to dangerous voltages or other hazards. Please call Optoma before you send the unit for repair.
7. Do not let objects or liquids enter the projector. They may touch dangerous voltage points and short out parts that could result in fire or electric shock.
8. See projector enclosure for safety related markings.
9. The unit should only be repaired by appropriate service personnel.

Precautions



Please follow all warnings, precautions and maintenance as recommended in this user's guide.



❖ When the lamp reaches the end of its life, the projector will not turn back on until the lamp module has been replaced. To replace the lamp, follow the procedures listed under “Replacing the Lamp” section on pages 90-91.

- | | |
|----------|---|
| Warning- | Do not look into the projector's lens when the lamp is on. The bright light may hurt your eyes. |
| Warning- | To reduce the risk of fire or electric shock, do not expose this projector to rain or moisture. |
| Warning- | Please do not open or disassemble the projector as this may cause electric shock. |
| Warning- | When replacing the lamp, please allow the unit to cool down. Follow instructions as described on pages 90-91. |
| Warning- | This projector will detect the life of the lamp itself. Please be sure to change the lamp when it shows warning messages. |
| Warning- | Reset the “Lamp Reset” function from the on-screen display “Options Lamp Settings” menu after replacing the lamp module (refer to page 79). |
| Warning- | When switching the projector off, please ensure the cooling cycle has been completed before disconnecting power. Allow 90 seconds for the projector to cool down. |
| Warning- | When the lamp is approaching to the end of its life time, the message “Lamp life exceeded.” will show on the screen. Please contact your local reseller or service center to change the lamp as soon as possible. |

Usage Notice

Do:

- ❖ Turn off and unplug the power plug from the AC outlet before cleaning the product.
- ❖ Use a soft dry cloth with mild detergent to clean the display housing.
- ❖ Disconnect the power plug from AC outlet if the product is not being used for a long period of time.

Do not:

- ❖ Block the slots and openings on the unit provided for ventilation.
- ❖ Use abrasive cleaners, waxes or solvents to clean the unit.
- ❖ Use under the following conditions:
 - In extremely hot, cold or humid environments.
 - ▶ Ensure that the ambient room temperature is within 5°C ~ 40°C
 - ▶ Relative humidity is 10% ~ 85%
 - In areas susceptible to excessive dust and dirt.
 - Near any appliance generating a strong magnetic field.
 - In direct sunlight.

Eye Safety Warnings



- ❖ Avoid staring/facing directly into the projector beam at all times. Keep your back to the beam as much as possible.
- ❖ When projector is used in a classroom, adequately supervise students when they are asked to point out something on the screen.
- ❖ In order to minimize the lamp power, use room blinds to reduce ambient light levels.



❖ Product features may vary depending on model.

Product Features

- ❖ 1080p (1920x1080)
- ❖ XGA (1024x768) / WXGA (1280x800) Native resolution
- ❖ HD compatible – 720p and 1080p supported
- ❖ BrilliantColor™ Technology
- ❖ Kensington Lock
- ❖ RS232 control
- ❖ Rapid shutdown
- ❖ Full 3D (See page 94)
- ❖ Crestron/Extron/ PJLink™ compatibility.
- ❖ Eco+ mode for more economic usage
- ❖ USB Power Charger
- ❖ Interactivity Support (Only for Interactive version)

Introduction

Package Overview

Unpack and inspect the box contents to ensure all parts listed below are in the box. If something is missing, please contact Optoma customer service.

Standard Accessories

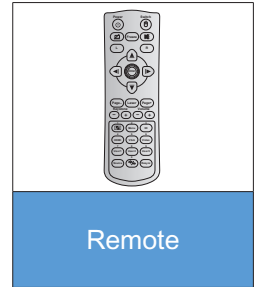
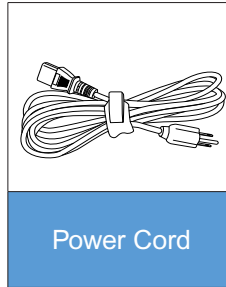
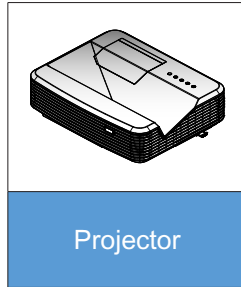

❖ For other laser curtain accessories, please refer to the laser curtain user manual.

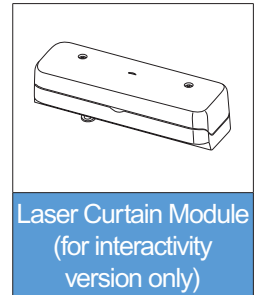
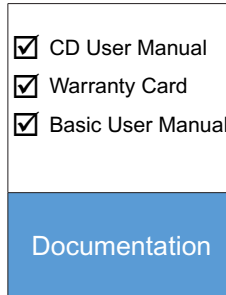
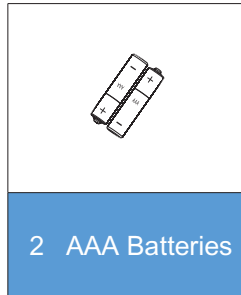

Optional Accessories



❖ Optional accessories vary depending on model, specification and region.

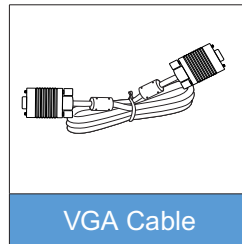
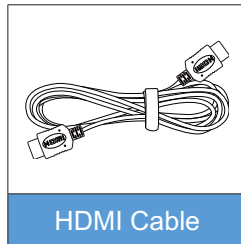

Product Overview

Main Unit

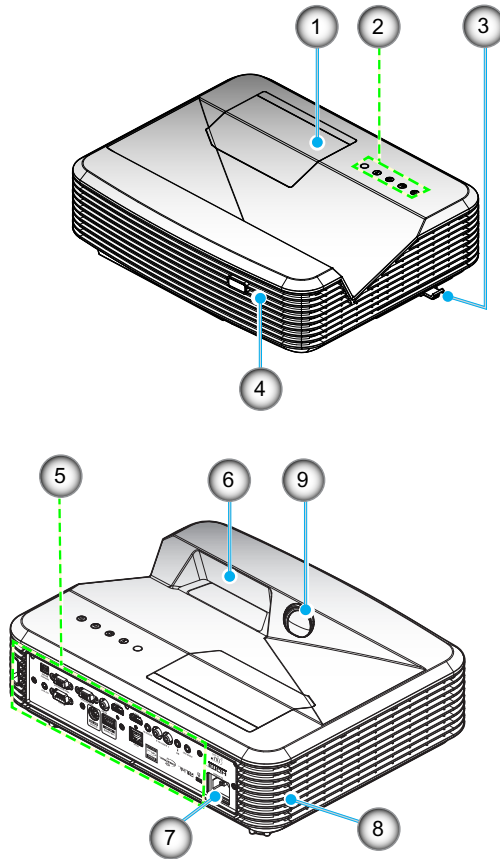

❖ Do not block projector in/out air vents.

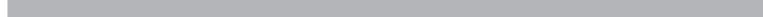

- | | |
|-----------------------------|---|
| 1. Lamp Cover | 6. Lens |
| 2. Control Panel | 7. Power Socket |
| 3. Focus Switch | 8. Speaker |
| 4. IR Receiver | 9. IR Camera (Only for interactive version) |
| 5. Input/Output Connections | |



Control Panel

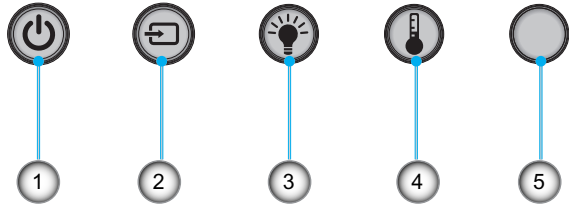

-
1. Power
 2. Source
 3. Lamp Indicator
 4. Temperature (Temp) Indicator
 5. IR Receiver
-

Introduction

Input/Output Connections

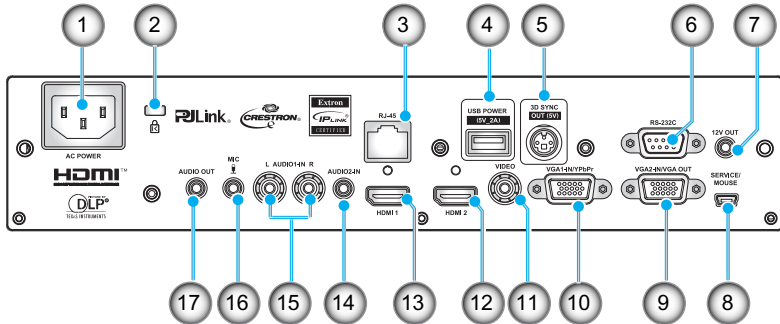

1. Power Socket
2. Kensington™ Lock Port
3. RJ45 Connector
4. USB Power Connector (5V/2A Max.)
5. 3D Sync Connector (5V)
6. RS-232C Connector (9-pin DIN Type)
7. 12V Audio Out Connector
8. USB Connector (Connect to PC for Remote Mouse function)
9. VGA-Out/VGA2-In Connector
10. VGA1-In/YPbPr Connector (PC Analog Signal/Component Video Input/HDTV/YPbPr)
11. Composite Video Input Connector
12. HDMI2 Input Connector
13. HDMI1 Input Connector
14. Audio 2 In Connector (3.5mm mini Jack)
15. Composite Audio Input (right/left) Connector
16. Audio Input Connector (microphone)
17. Audio Output Connector (3.5mm mini Jack)

NOTE

- ❖ Remote mouse requires special remote.

Introduction

Remote Control



❖ Some keys may have no function for models which do not support these features.

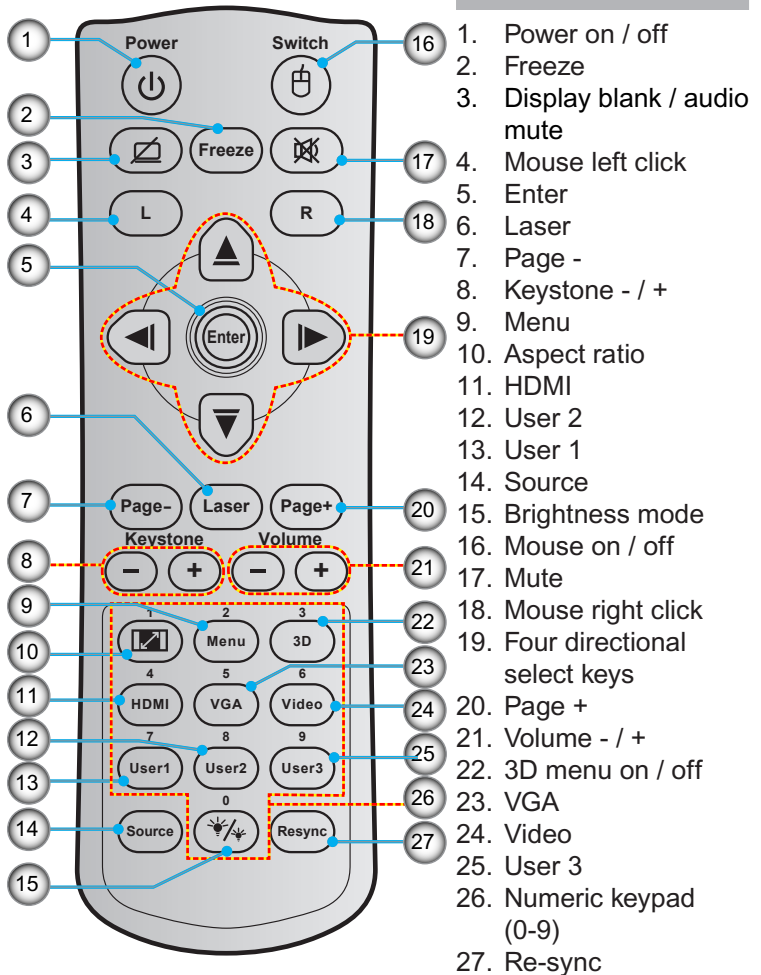

Installation

Connecting to the Projector

Connecting a Computer/Notebook

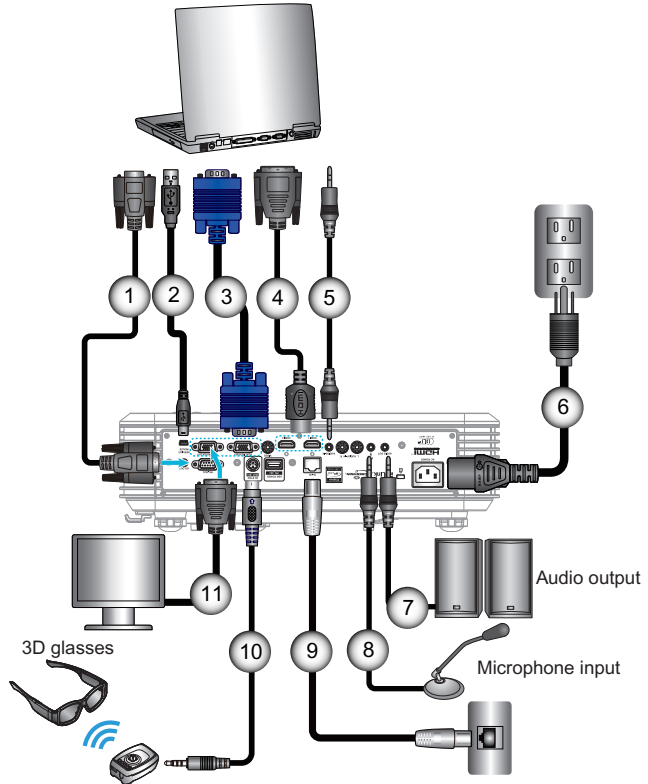

- ❖ Due to the difference in applications for each country, some regions may have different accessories.
- ❖ (*) Optional accessory

1.....	RS-232C cable
2.....	Remote Mouse USB cable
3.....	VGA1-In/YPbPr cable
4.....	*HDMI cable
5.....	Audio 2 In cable
6.....	Power cord
7.....	Audio Out cable
8.....	Audio In (microphone) cable
9.....	RJ-45 cable
10.....	*3D emitter cable
11.....	VGA-Out/VGA2-In cable

Installation

Connecting a Video source

DVD player, Blu-ray player, Set-top box,
HDTV receiver, Games console

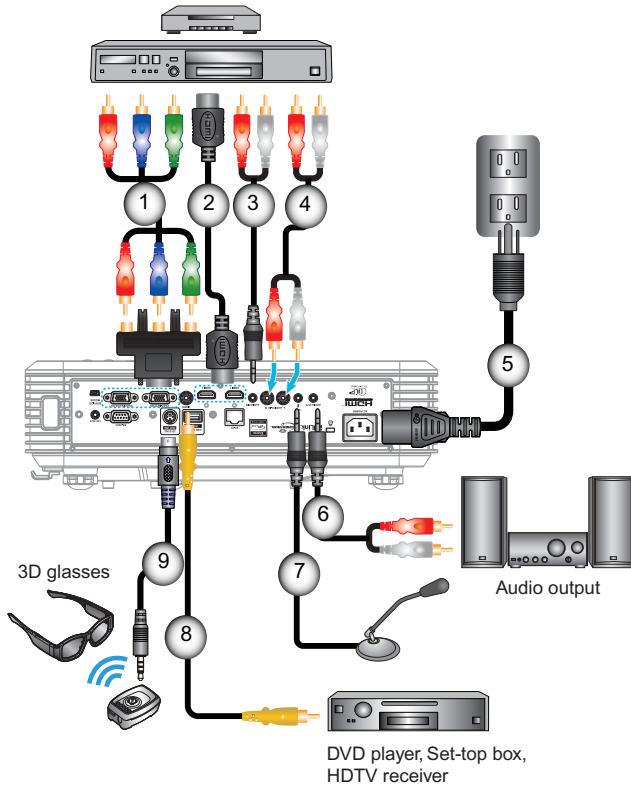

- ❖ Due to the difference in applications for each country, some regions may have different accessories.
- ❖ (*) Optional accessory

1.....	*3 RCA Component cable
2.....	*HDMI cable
3.....	*Audio2 In cable
4.....	Audio In cable
5.....	Power cord
6.....	*Audio Out cable
7.....	Microphone In cable
8.....	Video cable
9.....	*3D emitter cable

Connect to 3D Video Devices



- ❖ The 3D video source device must be powered on before the 3D projector.

Once you have connected your devices together with HDMI cables, as shown in the diagram, you are ready to begin. Power ON your 3D video source and your 3D projector.

PlayStation® 3 Games

- Make sure that you have updated your console to the latest software version.
- Go to the “Settings menu -> Display settings -> Video output -> HDMI”. Select “Automatic” and follow the on-screen instructions.
- Insert your 3D game disc. Alternatively you can download games (and 3D updates) via the PlayStation® network.
- Launch the game. In the in-game menu, select “Play in 3D”.

Blu-ray 3D™ Player

- Make sure that your player can support 3D Blu-ray™ disc and that 3D output is enabled.
- Insert the 3D Blu-ray™ disc into the player, press “Play”.

3D TV (e.g. SKY 3D, DirectTV)

- Contact your TV service provider to enable any 3D channels on your channel package.
- Once enabled, switch to the 3D channel.
- You should see two images side-by-side.
- Switch to the “SBS Mode” of the 3D projector. The option is located in the “Display” section of the projector OSD menu.

3D Device (e.g. 3D DV/DC) with 2D 1080i side by side signal output

- Connect your 3D device and switch to out 3D content with 2D side-by-side output to 3D Projector.
 - You should see two images side-by-side.
- Switch to the “SBS Mode” of the 3D projector. The option is located in the “Display” section of the projector OSD menu.

If watching 3D content from an HDMI 1.4a source (e.g. 3D Blu-ray) your 3D glasses should always be in sync. If watching 3D content from an HDMI 1.3 source (e.g. 3D broadcast using SBS mode) it may be necessary to use the projector’s 3D Sync-Invert option to optimize your 3D experience. The option is located in the “Display -> 3D” section of the projector OSD menu.



- ❖ If input video is normal 2D, please press “3D Format” and switch to “Auto”.
- ❖ If “SBS Mode” is active, 2D video content will not display correctly.

Installation

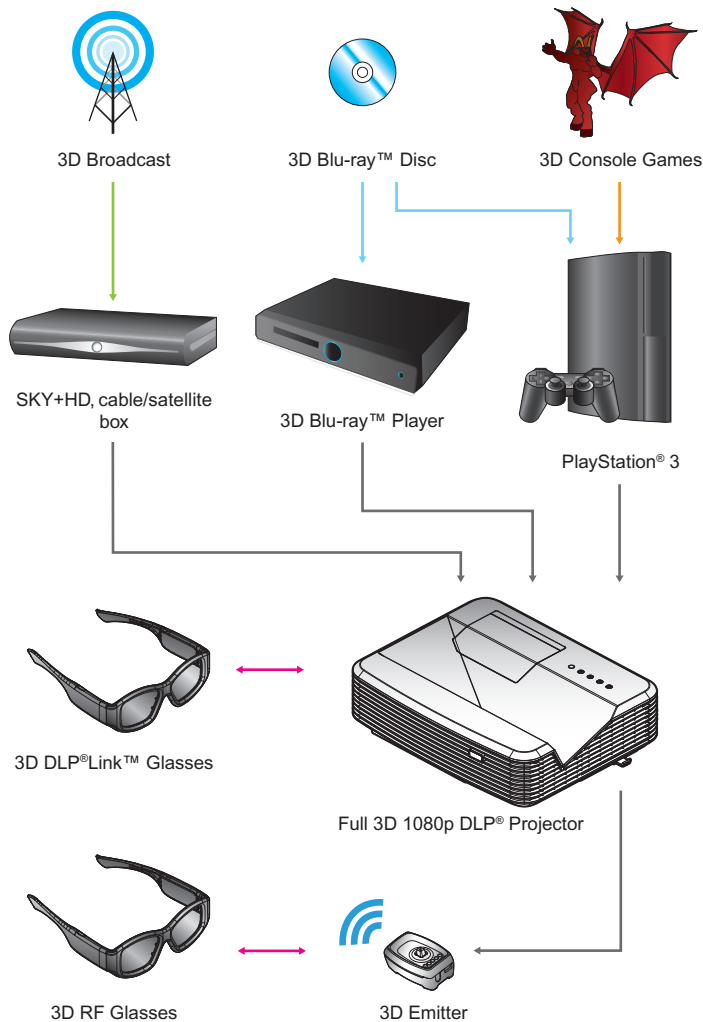



❖ For more detailed information, please refer to 3D glasses user's guide.

Using the 3D glasses

1. To turn ON 3D glasses.
2. Verify that 3D content is being sent to the projector and signal is compatible with projector specifications.
3. Turn on the "3D Mode" (Off/DLP-Link/VESA 3D - depending on which type of glasses you are using) of the 3D projector. The option is located in the "Display" section of the projector OSD menu.
4. Turn on 3D glasses and verify image appears in 3D without eyestrain.
5. If the image does not appear in 3D, please check 3D device set up correctly to send out 3D image or not. Or "SBS Mode" should turn on when input signal is 2D 1080i side-by-side and repeat previous steps 1 ~ 4.
6. It may be necessary to use projector's "3D Sync-Invert" option to optimize your 3D experience. The option is located in the "Display" section of the projector OSD menu.
7. To turn OFF 3D glasses: Press the "Power" button and hold until the LED switches off.
8. For more detailed information, please refer to the 3D glasses user's guide, or manufacturer's Website.

Powering On/Off the Projector

Powering On the Projector

1. Securely connect the power cord and signal cable. When connected, the On/Standby LED will turn Red.
2. Turn on the lamp by pressing “

The startup screen will display in approximately 10 seconds. The first time you use the projector, you will be asked to select the preferred language and power saving mode.

3. Turn on and connect the source that you want to display on the screen (computer, notebook, video player, etc). The projector will detect the source automatically. If not, push menu button and go to “OPTIONS”.
Make sure that the “Source Lock” has been set to “Off”.
- ❖ If you connect multiple sources at the same time, press the “SOURCE” button on the Remote Control or direct source keys on the remote control to switch between inputs.



- ❖ Turn on the projector first and then select the signal sources.
- ❖ (*) Optional accessory.

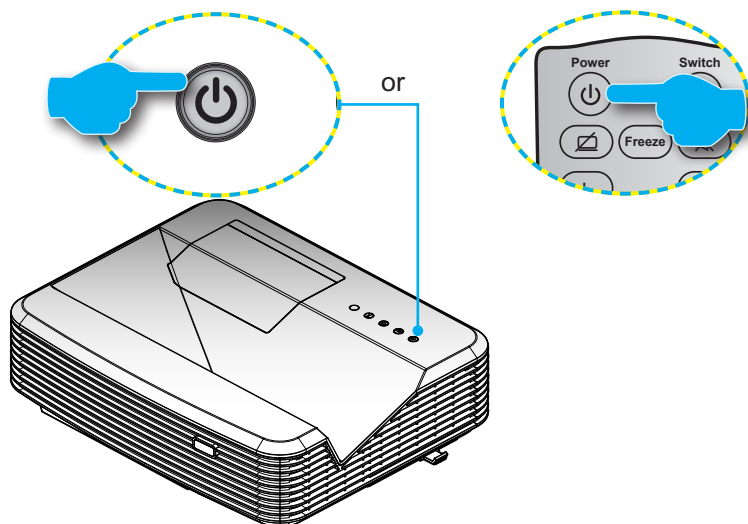

Powering Off the Projector

1. Press the “⏻” button on the remote control or on the Control Panel to turn off the projector. The following message will be displayed on the screen.



Press the “⏻” button again to confirm otherwise the message will disappear after 15 seconds. When you press the “⏻” button for the second time, the projector will display countdown timer and will shut down.

2. The cooling fans continue to operate for about 10 seconds for cooling cycle and the On/Standby LED will flash Blue. When the On/Standby LED lights solid Red, the projector has entered standby mode.

If you wish to turn the projector back on, you must wait until the projector has completed the cooling cycle and has entered standby mode. Once in standby mode, simply press “⏻” button to restart the projector.

3. Disconnect the power cord from the electrical outlet and the projector.
4. Do not turn on the projector immediately following a power off procedure.



- ❖ Contact the nearest service center if the projector displays these symptoms. See pages 105-106 for more information.

Warning Indicator

When the warning indicators (see below) come on, the projector will automatically shutdown:

- ❖ “LAMP” LED indicator is lit red and if “On/Standby” indicator flashes red.
- ❖ “TEMP” LED indicator is lit red and if “On/Standby” indicator flashes red. This indicates the projector has overheated. Under normal conditions, the projector can be switched back on.
- ❖ “TEMP” LED indicator flashes red and if “On/Standby” indicator flashes red.

Unplug the power cord from the projector, wait for 30 seconds and try again. If the warning indicator light up again, please contact your nearest service center for assistance.

Adjusting the Projected Image

Adjusting the Projector's Height

The projector is equipped with elevator feet for adjusting the image height.

1. Locate the adjustable foot you wish to modify on the underside of the projector.
2. Rotate the adjustable ring clockwise to raise the projector or counter clockwise to lower it. Repeat with the remaining feet as needed.

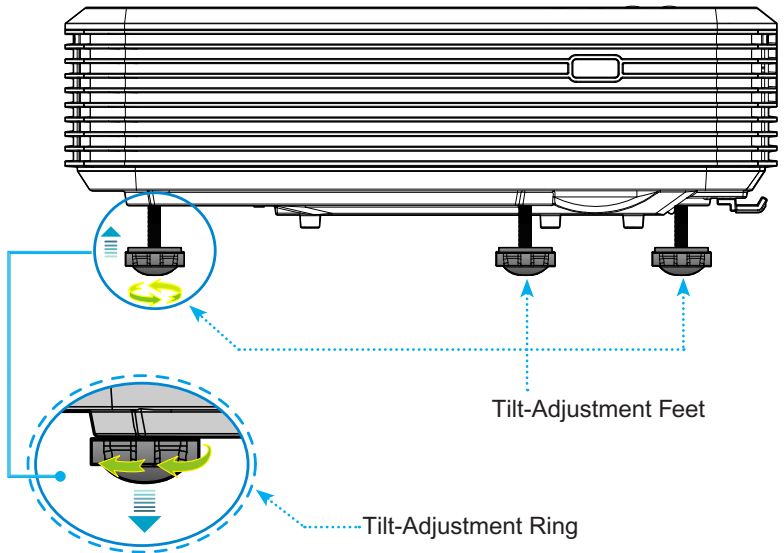

Adjusting the Projector's Focus

To focus the image, slide the focus switch until the image is clear.

- ▶ Standard throw series (XGA): The projector will focus at distances from 1.55 to 2.21 feet (0.47 to 0.68 meters) counted from the center of lens..
- ▶ Standard throw series (WXGA): The projector will focus at distances from 1.59 to 2.15 feet (0.49 to 0.66 meters) counted from the center of lens..
- ▶ Standard throw series (1080p): The projector will focus at distance from 1.46 to 1.83 feet (0.45 to 0.56 meters) counted from the center of lens.

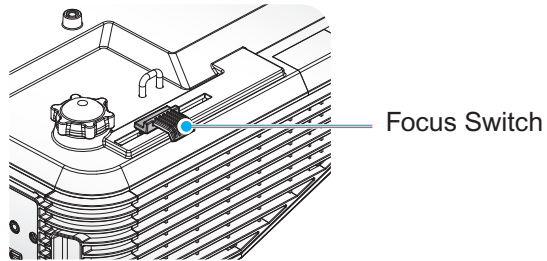

Adjusting Projection Image Size

- ▶ Projection Image Size (XGA) from 70"-100" (1.78 to 2.54 meters).
- ▶ Projection Image Size (WXGA) from 85"-115" (2.16 to 2.92 meters).
- ▶ Projection Image Size (1080p) from 80"-100" (2.03 to 2.54 meters).

Installation

Variables:

"**a**": Image Offset (m) from the center of the lens to the top of the vertical image.

"**b**": Distance from the center of the lens to the bottom of the projector.

"**c**": Distance between the wall (projection surface) to the back of the projector.

"**d**": Image Diagonal.

"**g**": Distance between the center of the lens and wall (projection surface).

"**m**": Distance between the wall (projection surface) and the front of the projector.

"**p**": Distance from top of projector to the mounting hole.

"**H**": Height of the Image.

"**W**": Width of the image.

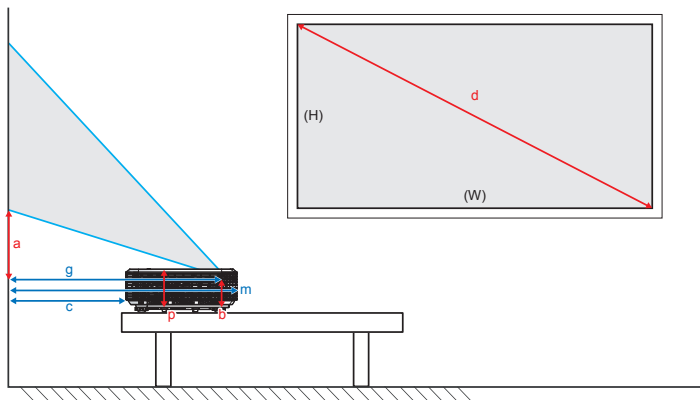
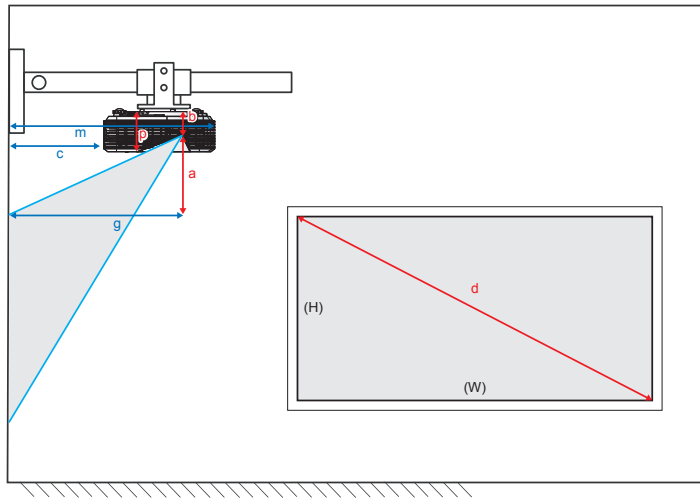

Installation

Standard throw XGA (4:3)

a Image Offset from the center of the lens to the top of the vertical image (m)	b Distance from center of lens to the bottom of projector (m)	c Distance between the wall (projection surface) to the back of projector (m)	d Image Diagonal (inch)	W Width of Image Size		H Height of Im- age Size		g Distance between the center of lens and wall (projection surface)		m Distance between the wall (projection surface) and the front of the projec- tor (m)	P Distance from top of projector to mounting hole (m)
				(inch)	(m)	(inch)	(m)	(feet)	(m)		
				0.181	0.0631	0.219	70	56.0	1.42		
0.192	0.0631	0.246	74	59.2	1.50	44.4	1.13	1.64	0.50	0.5559	0.119
0.207	0.0631	0.287	80	64.0	1.63	48.0	1.22	1.77	0.54	0.5969	0.119
0.233	0.0631	0.354	90	72.0	1.83	54.0	1.37	1.99	0.61	0.6839	0.119
0.259	0.0631	0.422	100	80.0	2.03	60.0	1.52	2.21	0.68	0.7319	0.119

Standard throw WXGA (16:10)

a Image Offset from the center of the lens to the top of the vertical image (m)	b Distance from center of lens to the bottom of projector (m)	c Distance between the wall (projection surface) to the back of projector (m)	d Image Diagonal (inch)	W Width of Image Size		H Height of Im- age Size		g Distance between the center of lens and wall (projection surface)		m Distance between the wall (projection surface) and the front of the projec- tor (m)	P Distance from top of projector to mounting hole (m)
				(inch)	(m)	(inch)	(m)	(feet)	(m)		
				0.172	0.0631	0.232	85	72.1	1.83		
0.176	0.0631	0.245	87	74.0	1.88	46.2	1.17	1.63	0.50	0.5549	0.119
0.182	0.0631	0.261	90	76.4	1.94	47.7	1.21	1.69	0.51	0.5709	0.119
0.202	0.0631	0.318	100	84.8	2.15	53.0	1.35	1.87	0.57	0.6279	0.119
0.222	0.0631	0.375	110	93.3	2.37	58.3	1.48	2.06	0.63	0.6849	0.119
0.232	0.0631	0.403	115	97.5	2.48	60.9	1.55	2.15	0.66	0.7129	0.119

Standard throw 1080p (16:9)

a Image Offset from the center of the lens to the top of the vertical image (m)	b Distance from center of lens to the bottom of projector (m)	c Distance between the wall (projection surface) to the back of projector (m)	d Image Diagonal (inch)	W Width of Image Size		H Height of Im- age Size		g Distance between the center of lens and wall (projection surface)		m Distance between the wall (projection surface) and the front of the projec- tor (m)	P Distance from top of projector to mounting hole (m)
				(inch)	(m)	(inch)	(m)	(feet)	(m)		
				0.179	0.0631	0.193	80	69.7	1.77		
0.200	0.0631	0.244	89	77.6	1.97	43.7	1.11	1.63	0.50	0.5539	0.119
0.202	0.0631	0.249	90	78.4	1.99	44.1	1.12	1.65	0.50	0.5589	0.119
0.224	0.0631	0.305	100	87.2	2.21	49.0	1.25	1.83	0.56	0.6149	0.119





❖ These tables are for user's reference only.

Control Panel & Remote Control

Control Panel



Using the Control Panel

POWER		Refer to the “Power On/Off the Projector” section on pages 16-17.
SOURCE		Press  to select an input signal.
Lamp LED		Indicate the projector’s lamp status.
Temp LED		Indicate the projector’s temperature status.
IR Receiver		Receives infrared signals from the remote control.

User Controls

Remote Control



Using the Remote Control

Power		Press to turn on / off the projector.
Switch		Press to switch the USB mouse on / off.
Display blank / audio mute		Press to hide / unhide the screen picture and turn off / on audio.
Freeze		Press to freeze the projector image.
Mute		Press to momentarily turn off / on the audio.
Mouse left click	L	Use as mouse left click.
Mouse right click	R	Use as mouse right click.
Four directional select keys		Use ▲ ▼ ◀ ▶ to select items or make adjustments to your selection.
Enter		Confirm your item selection.
Page -		Press to page down.
Laser		Use as laser pointer.
Page +		Press to page up.
Keystone		Press to adjust image distortion caused by tilting the projector.
Volume		Press to adjust to increase / decrease the volume.
Aspect ratio / 1		<ul style="list-style-type: none"> ▶ Press to change aspect ratio of a displayed image. ▶ Use as numeric keypad number "1".
Menu / 2		<ul style="list-style-type: none"> ▶ Press to display or exit the on-screen display menus for projector. ▶ Use as numeric keypad number "2".

User Controls

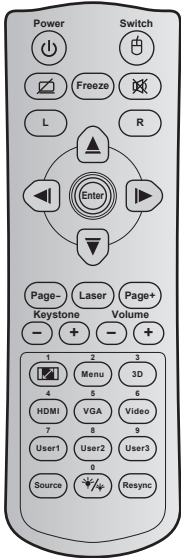

Using the Remote Control

3D / 3	<ul style="list-style-type: none"> ▶ Press to manually select a 3D mode that matches your 3D content. ▶ Use as numeric keypad number “3”.
HDMI / 4	<ul style="list-style-type: none"> ▶ Press to choose HDMI source. ▶ Use as numeric keypad number “4”.
VGA / 5	<ul style="list-style-type: none"> ▶ Press to choose VGA source. ▶ Use as numeric keypad number “5”.
Video / 6	<ul style="list-style-type: none"> ▶ Press to choose composite video source. ▶ Use as numeric keypad number “6”.
User1 / 7; User2 / 8; User3 / 9	<ul style="list-style-type: none"> ▶ User defined keys. ▶ Use as numeric keypad numbers “7”, “8”, and “9” accordingly.
Source	Press to select an input signal.
Brightness mode / 0	<div style="display: flex; align-items: center;">  <ul style="list-style-type: none"> ▶ Press to automatically adjust the picture brightness to give an optimum contrast performance. ▶ Use as numeric keypad number “0”. </div>
Re-sync	Press to automatically synchronize the projector to the input source.

User Controls

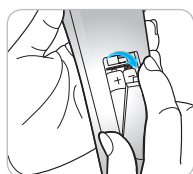
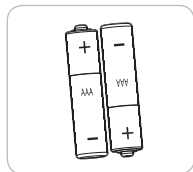

Installing Batteries

Two size AAA batteries are supplied for Remote Control.

Replace only with the same or equivalent type recommended by the manufacturer.



CAUTION

Improper use of batteries can result in chemical leakage or explosion. Be sure to follow the instructions below.

Do not mix batteries of different types. Different types of batteries have different characteristics.

Do not mix old and new batteries. Mixing old and new batteries can shorten the life of new batteries or cause chemical leakage in old batteries.

Remove batteries as soon as they are worn out. Chemicals that leak from batteries that come in contact with skin can cause a rash. If you find any chemical leakage, wipe thoroughly with a cloth.

The batteries supplied with this product may have a shorter life expectancy due to storage conditions.

If you will not be using the remote control unit for an extended period of time, remove batteries from it.

When you dispose of the battery, you must obey the law in the relative area or country.

On-screen Display Menus

The Projector has multilingual On-screen Display menus that allow you to make image adjustments and change a variety of settings. The projector will automatically detect the source.

How to operate

1. To open the OSD menu, press “Menu” on the Remote Control or Control Panel.
2. When OSD is displayed, use ◀▶ keys to select any item in the main menu. While making a selection on a particular page, press ▼ or “Enter” key to enter sub menu.
3. Use ▲▼ keys to select the desired item in the sub menu and then press ▶ or “Enter” key to view further settings. Adjust the settings by ◀▶ key.
4. Select the next item to be adjusted in the sub menu and adjust as described above.
5. Press “Enter” or “Menu” to confirm, and the screen will return to the main menu.
6. To exit, press “Menu” again. The OSD menu will close and the projector will automatically save the new settings.

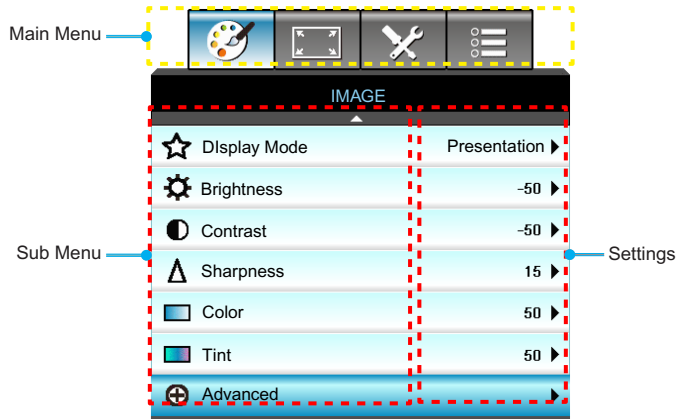

User Controls









Menu Tree

Main Menu	Sub Menu	Advanced Menu	Parameter	Single Item in the Menu	Value or Default	Notes		
IMAGE	Display Mode			Presentation / Bright / Movie / sRGB / Blackboard / DICOM SIM. / 3D / User		Each mode can adjust and save to user mode.		
	Brightness				-50~ +50			
	Contrast				-50~ +50			
	Sharpness				1~ 15			
	Color				-50~ +50			
	Tint				-50~ +50			
	Advanced	Noise Reduction				0~10		
		BrilliantColor™				1~10		
		Gamma			Film/ Graphic/1.8/2.0/2.2/2.6/ Blackboard / DICOM SIM./3D		All gamma could be selected for all display modes.	
		Color Temp.			Standard/Cool / Cold			
		Color Space				Not HDMI Input: Auto / RGB / YUV	Auto	
						HDMI Input: Auto/ RGB(0~255) / RGB(16~235)/ YUV	Auto	
		RGB Gain/Bias	Red Gain					
			Green Gain					
			Blue Gain					
			Red Bias					
			Green Bias					
			Blue Bias					
			Reset					To reset current source with current display mode for RGB Gain/Bias
		Exit						
		Color Matching	Red			Hue/ Saturation /Gain/ Exit	-50~ +50	
	Green				Hue/ Saturation /Gain/ Exit	-50~ +50		
	Blue				Hue/ Saturation /Gain/ Exit	-50~ +50		

User Controls

Main Menu	Sub Menu	Advanced Menu	Parameter	Single Item in the Menu	Value or Default	Notes
IMAGE	Advanced	Color Matching	Cyan	Hue/ Saturation /Gain/ Exit	-50~ +50	
			Magenta	Hue/ Saturation /Gain/ Exit	-50~ +50	
			Yellow	Hue/ Saturation /Gain/ Exit	-50~ +50	
			White	R/G/B/Exit	-50~ +50	
			Reset			To reset current source with current display mode for CMS settings
		Exit				
	Reset			Yes/No		To reset current source with current display mode for image settings.
DISPLAY	Format			4:3	Auto	
				16:9/16:10[WXGA]		
				LBX		
				Native		
				Auto	Default is "Auto"	
	Zoom				-5 ~ +25	
	Edge Mask				0 ~ 10	
	Image Shift	H			-50~ +50	Up/Down/Right/Left(Icon in center)
V				-50~ +50		
V Keystone					-15~ +15	1080p: -5~+5
IMAGE	3D	3D Mode		DLP-Link/ VESA 3D /Off (For projector don't have VESA port, use " IR ")	DLP-Link	
		3D->2D		3D/ L/ R		The items would be greyed out when 3D mode sets to Off.
		3D Format		Auto/SBS/Top and Bottom/Frame Sequntail		
		3D Sync Invert		On/Off	Off	
		Exit				

User Controls

Main Menu	Sub Menu	Advanced Menu	Parameter	Single Item in the Menu	Value or Default	Notes	
SETUP	Language			English / Deutsch / Français / Italiano / Español / Português / Polski / Nederlands / Svenska / Norsk/Dansk / Suomi / ελληνικά / 繁体中文 / 简体中文 / 日本語 / 한국어 / Русский / Magyar / Čeština / العربية / Türkçe / Farsi / Romanian / Slovakian	English		
	Projection			Front-Desktop 	Front Ceiling		
				Rear-Desktop 			
				Front-Ceiling 			
				Rear-Ceiling 			
	Screen Type			16:10/16:9 (WXGA MODEL)	Default is "16:10"		
	Menu Location				Top Left 	Center	
					Top Right 		
					Center 		
					Bottom Left 		
				Bottom Right 			

User Controls

Main Menu	Sub Menu	Advanced Menu	Parameter	Single Item in the Menu	Value or Default	Notes		
SETUP	Security	Security Setting		On/Off	Off	Password is required if "Security" is selected.		
		Security Timer		Month	0~12			
				Day	0~30			
				Hour	0~24			
				Exit				
		Change Password						
	Exit							
	Signal (RGB)	Frequency				-5~+5	Depends on signal	
		Phase				0~63		
		H. Position				-5~+5		
		V. Position				-5~+5		
		Automatic	Enable/Disable					
		Exit						
	Signal (Video)	White Level				-50~+50		
		Black Level				-50~+50		
		Exit						
	Projector ID					00~99		
	Auto Settings	Internal Speaker			On/Off	On	Audio 1 (RCA) for Composite Audio 2 (Mini jack) for VGA	
		Mute			On/Off	Off		
		Volume	Audio					0-10
			MIC					0-10
		Audio Input			Default/ Audio 1/ Audio 2	Default		
	Exit							
Advanced	Logo			Optoma/ Neutral /User	Optoma			
	Logo Capture							
	Closed Captioning			CC1/CC2/Off	Off			
	Exit							

User Controls

Main Menu	Sub Menu	Advanced Menu	Parameter	Single Item in the Menu	Value or Default	Notes
SETUP	Network	LAN Settings	Network Status	Read-Only		Never time-out on this page.
			DHCP	On/Off		
			IP Address			
			Subnet Mask			
			Gateway			
			DNS			
			Apply	Yes/No		
			MAC Address	Read-Only		
			Exit			
		Control Settings	Crestron	On/Off	On	
			Extron	On/Off	On	
			PJ Link	On/Off	On	
			AMX Device Discovery	On/Off	On	
			Telnet	On/Off	On	
Exit						
OPTIONS	Input Source			HDMI 1/HDMI 2/VGA 1/VGA 2/Video		When no signal input, user still could do selection for "Input Source" from OSD.
				Exit		
	Source Lock			On/Off	Off	
	High Altitude			On/Off	Off	
	Information Hide			On/Off	Off	
	Keypad Lock			On/Off	Off	
	Test Pattern			None / Grid(white) / Grid(Green) / Grid(Magenta) / White	None	
	Background Color			Blue / Black / Red / Green / White	Blue	Default is Blue
	12V Trigger			On/Off	On	
VGA2 Switch			In/Out	Out		

User Controls

Main Menu	Sub Menu	Advanced Menu	Parameter	Single Item in the Menu	Value or Default	Notes
OPTIONS	Advanced	Direct Power On		On/Off		
		Signal Power on		On/Off		
		Auto Power Off (min)			0~180	
		Sleep Timer (min)			0~990	
		Power Mode (Standby)		Active/ Eco.	Eco.	
		Quick Resume		On/Off	Off	
	Remote Settings	User 1		HDMI2/VGA2/Test Pattern/LAN/Brightness/ Contrast/Sleep Timer/ Color Matching/Color Temp/Gamma/ Source Lock /Projection/Lamp Settings/ Zoom/Freeze	HDMI2	
		User 2		HDMI2/VGA2/Test Pattern/LAN/Brightness/ Contrast/Sleep Timer/ Color Matching/Color Temp/Gamma/ Source Lock /Projection/Lamp Settings/ Zoom/Freeze	VGA2	
		User 3		HDMI2/VGA2/Test Pattern/LAN/Brightness/ Contrast/Sleep Timer/ Color Matching/Color Temp/Gamma/ Source Lock /Projection/Lamp Settings/ Zoom/Freeze	Test Pattern	
		Exit				
	Lamp Settings	Lamp Hour		Read-Only[Range 0~ 9999]		
		Lamp Reset		Yes/No	No	
		Lamp Reminder		On/Off	On	
		Brightness Mode		Bright/Eco./Dynamic/ Eco+	Bright	
		Exit				
	Filter Settings	Filter Usage Hours		Read-Only [Range 0~ 9999]		
		Filter Reminder		Off/ 300hr/500hr/800hr/1000hr	500hr	
		Filter Reset		Yes/No	No	
		Exit				

User Controls

Main Menu	Sub Menu	Advanced Menu	Parameter	Single Item in the Menu	Value or Default	Notes
OPTIONS	Reset			Current/All		The definition of Current: To reset all OSD settings to be default for current source and current timing. The definition of All: To reset all OSD settings to be default for all source and all timing..

IMAGE

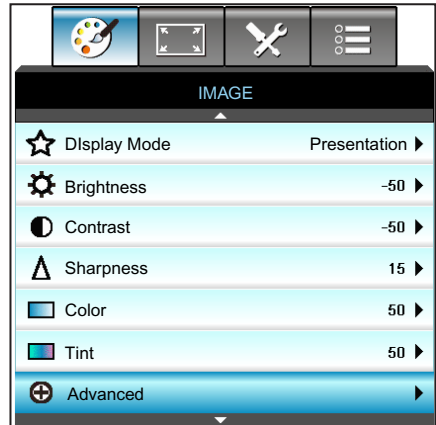

Display Mode

There are many factory presets optimized for various types of images.

- ▶ Presentation: This mode is suitable for showing in front of public in connection to the PC.
- ▶ Bright: Maximum brightness from PC input.
- ▶ Movie: This mode is suitable for watching video.
- ▶ User: Memorize user's settings.
- ▶ Blackboard: This mode should be selected to achieve optimum color settings when projecting onto a blackboard (green).
- ▶ DICOM SIM.: This mode can project a monochrome medical image such as an X ray radiography, MRI, etc.
- ▶ sRGB: Standardized accurate color.
- ▶ 3D: To experience the 3D effect, you need to have 3D glasses, make sure your PC/portable device has a 120 Hz signal output quad buffered graphics card and have a 3D Player installed.

User Controls

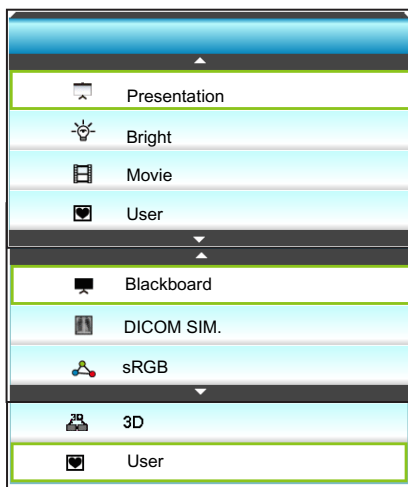

Brightness

Adjust the brightness of the image.

- ▶ Press the ◀ to darken image.
- ▶ Press the ▶ to lighten the image.



Contrast

The contrast controls the degree of difference between the lightest and darkest parts of the picture.

- ▶ Press the ◀ to decrease the contrast.
- ▶ Press the ▶ to increase the contrast.



User Controls

Sharpness

Adjust the sharpness of the image.

- ▶ Press the ◀ to decrease the sharpness.
- ▶ Press the ▶ to increase the sharpness.



Color

Adjust a video image from black and white to fully saturated color.

- ▶ Press the ◀ to decrease the amount of saturation in the image.
- ▶ Press the ▶ to increase the amount of saturation in the image.



Tint

Adjust the color balance of red and green.

- ▶ Press the ◀ to increase the amount of green in the image.
- ▶ Press the ▶ to increase the amount of red in the image.



Reset

Choose "Yes" to return the factory default settings for "IMAGE".

Exit

Choose "Exit" to exit the menu.

IMAGE / Advanced

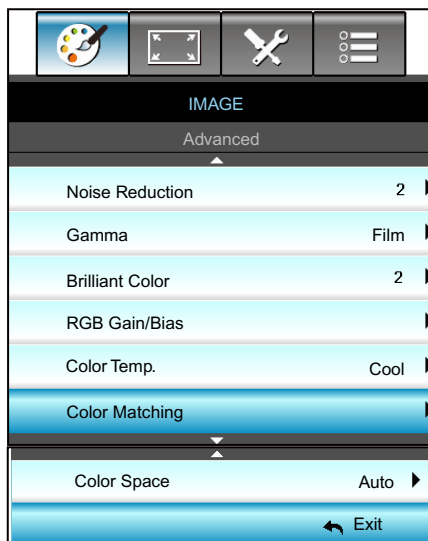

Noise Reduction

Selects a filter sensitivity to noise. A higher value may improve noisy sources, but it will soften the image.

- ▶ Press the ◀ to decrease the noise in the image.
- ▶ Press the ▶ to increase the noise in the image.

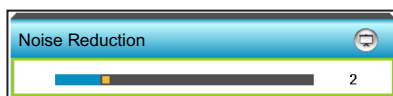

Gamma

This allows you to set up gamma curve type. After the initial setup and fine tuning is completed, utilize the Gamma Adjustment steps to optimize your image output.

- ▶ Film: for home theater.
- ▶ Graphics: for PC / Photo source.
- ▶ Blackboard: This mode should be selected to achieve optimum color settings when projecting onto a blackboard (green).
- ▶ DICOM SIM.: This mode can project a monochrome medical image such as an X ray radiography, MRI, etc.

Press the ◀ or ▶ to select the mode.



User Controls

BrilliantColor™

This adjustable item utilizes a new color-processing algorithm and enhancements to enable higher brightness while providing true, more vibrant colors in picture.

- ▶ Press the ◀ to stronger enhance the image.
- ▶ Press the ▶ to less enhance the image.



RGB Gain/Bias

This settings allows to configure the brightness (gain) and contrast (bias) of an image.

- ▶ Press the ◀ to decrease a chosen color gain and bias.
- ▶ Press the ▶ to increase a chosen color gain and bias.

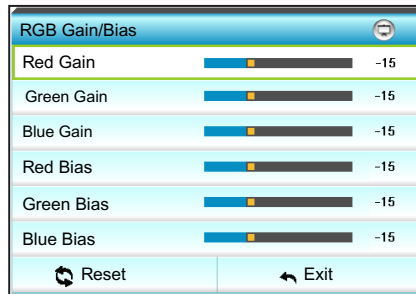

Color Temp.

Press the ◀ or ▶ to select a color temperature from Standard, Cool and Cold.

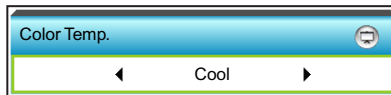

User Controls

Color Matching

Press the ► into the next menu and then use ▲ or ▼ or ◀ or ▶ to select the item.



- ▶ Red: Press the ▲ or ▼ to select Hue, Saturation and Gain Colors. Then press the ◀ or ▶ to decrease or increase the value respectively.

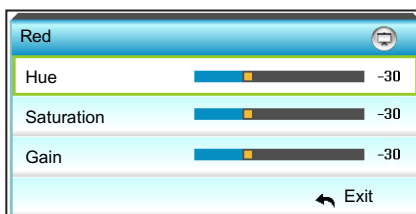

- ▶ Cyan: Press the ▲ or ▼ to select Hue, Saturation and Gain Colors. Then press the ◀ or ▶ to decrease or increase the value respectively.

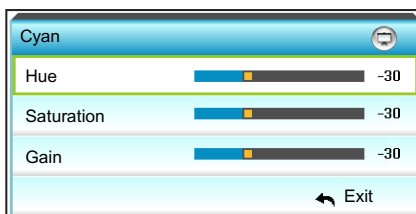

User Controls

- ▶ Green: Press the ▲ or ▼ to select Hue, Saturation and Gain Colors. Then press the ◀ or ▶ to decrease or increase the value respectively.

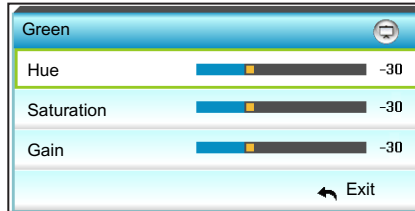

- ▶ Magenta: Press the ▲ or ▼ to select Hue, Saturation and Gain Colors. Then press the ◀ or ▶ to decrease or increase the value respectively.

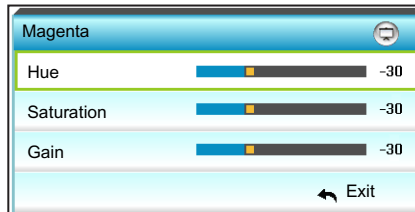

- ▶ Blue: Press the ▲ or ▼ to select Hue, Saturation and Gain Colors. Then press the ◀ or ▶ to decrease or increase the value respectively.

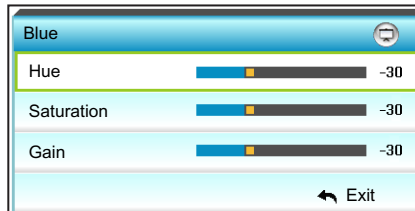

- ▶ Yellow: Press the ▲ or ▼ to select Hue, Saturation and Gain Colors. Then press the ◀ or ▶ to decrease or increase the value respectively.

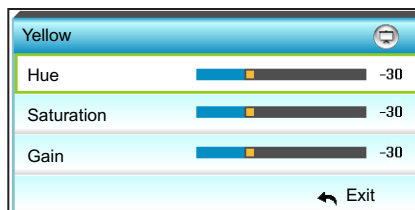

User Controls

- ▶ White: Press the ▲ or ▼ to select Hue, Saturation and Gain Colors. Then press the ◀ or ▶ to decrease or increase the value respectively.

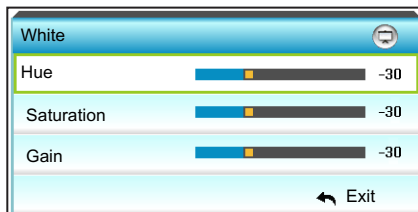

- ▶ Reset: Choose "Reset" to return the factory default settings for color adjustments.

Color Space

Press the ◀ or ▶ to select an appropriate color matrix type from the following:

- ▶ Non-HDMI Input: Auto, RGB or YUV
- ▶ HDMI Input: Auto, RGB(0-255), RGB(16-235) or YUV.



Reset

- ▶ Current: Choose "Yes" to return the display parameters on this menu to the factory default settings.
- ▶ All: Choose "Yes" to return the display parameters on all menus to the factory default settings.

Exit

Choose "Exit" to exit the menu.

DISPLAY



Format

Press the ◀ or ▶ to choose your desired aspect ratio between 4:3, 16:9/16:10 (WXGA), LBX, Native, and Auto.

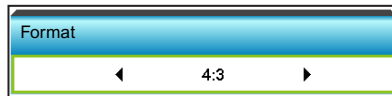

XGA

- ▶ 4:3: This format is for 4:3 input sources.
- ▶ 16:9: This format is for 16:9 input sources, like HDTV and DVD enhanced for Wide screen TV.
- ▶ Native: This format displays the original image without any scaling.
- ▶ AUTO: Automatically selects the appropriate display format.

Source	480i/p	576i/p	1080i/p	720p
4:3	Scale to 1024 x 768			
16:9	Scale to 1024 x 576			
Native	No scaling will be made; the resolution is dependent on which input source and is then displayed.			
Auto	<ul style="list-style-type: none"> ▶ If source is 4:3, it will be auto resized to 1024 x 768 ▶ If source is 16:9, it will be auto resized to 1024 x 576 ▶ If source is 15:9, it will be auto resized to 1024 x 614 ▶ If the source is 16:10, it will be auto resized to 1024 x 640 			

User Controls

WXGA

- ▶ 4:3: This format is for 4:3 input sources.
- ▶ 16:9: This format is for 16:9 input sources, like HDTV and DVD enhanced for Wide screen TV.
- ▶ 16:10: This format is for 16:10 input sources, like widescreen laptops.
- ▶ LBX: This format is for non-16x9, letterbox source and for users who use external 16x9 lens to display 2.35:1 aspect ratio using full resolution.
- ▶ Native: This format displays the original image without any scaling.
- ▶ AUTO: Automatically selects the appropriate display format.

Detail informations about LBX mode:

1. Some Letter-Box Format DVDs are not enhanced for 16x9 TVs. In this situation, the image will not look right when displayed in 16:9 mode. In this situation, please try to using the 4:3 mode to view the DVD. If the content is not 4:3, there will be black bars around the image in 16:9 display. For this type of content, you can use LBX mode to fill the image on the 16:9 display.
2. If you use an external anamorphic lens, this LBX mode also allows you to watch a 2.35:1 content (include Anamorphic DVD and HDTV film source) that support anamorphic wide is enhanced for 16x9 Display in a wide 2.35:1 image. In this case, there are no black bars. Lamp power and vertical resolution are fully utilized.

16:9 Screen	480i/p	576i/p	1080i/p	720p	PC
4:3	Scale to 960 x 720				
16:9	Scale to 1280 x 720				
LBX	Scale to 1280 x 960, in order to get the central 1280 x 720 image displayed on the screen.				
Native	1:1 mapping centered		1:1 mapping display 1280 x 720	1280 x 720 centered	1:1 mapping centered
Auto	<ul style="list-style-type: none"> ▶ If this format is selected, the screen type will automatically set to 16:9 (1280 x 720) ▶ If source is 4:3, it will be auto resized to 960 x 720 ▶ If source is 16:9, it will be auto resized to 1280 x 720 ▶ If source is 15:9, it will be auto resized to 1200 x 720 ▶ If the source is 16:10, it will be auto resized to 1152 x 720 				

User Controls

16:10 Screen	480i/p	576i/p	1080i/p	720p	PC
4:3	Scale to 1066 x 800				
16:10	Scale to 1280 x 800				
LBX	Scale to 1280 x 960, in order to get the central 1280 x 800 image displayed on the screen.				
Native	1:1 mapping centered	1:1 mapping display 1280 x 800	1280 x 720 centered	1:1 mapping centered	
Auto	<ul style="list-style-type: none"> ▶ Input source will be fit into 1280x800 display area and be kept its original aspect ratio ▶ If source is 4:3, auto resize to 1066 x 800 ▶ If source is 16:9 auto resize to 1280 x 720 ▶ If source is 15:9 auto resize to 1280 x 768 ▶ If source is 16:10 auto resize to 1280 x 800 				

1080P

- ▶ 4:3: This format is for 4:3 input sources.
- ▶ 16:10: This format is for 16:10 input sources, like widescreen laptops.
- ▶ LBX: This format is for non-16x9, letterbox source and for users who use external 16x9 lens to display 2.35:1 aspect ratio using full resolution.
- ▶ Native: This format displays the original image without any scaling.
- ▶ AUTO: Automatically selects the appropriate display format.

16:9 Screen	480i/p	576i/p	1080i/p	720p	PC
4:3	Scale to 1440 x 1080				
16:10	Scale to 1920x1080				
LBX	Scale to 1920 x 1440, in order to get the central 1920 x 1080 image displayed on the screen.				
Native	1:1 mapping centered No scaling will be made; the resolution is dependent on which input source and is then displayed.				
Auto	<ul style="list-style-type: none"> ▶ If this format is selected, the screen type will automatically become 16:9 ▶ If source is 4:3, auto resize to 1440 x 1080 ▶ If source is 16:9 auto resize to 1920 x 1080 ▶ If source is 16:10 auto resize to 1920 x 1200 and cut to 1920 x 1080 area display 				

User Controls

Zoom

- ▶ Press the ◀ to reduce the size of an image.
- ▶ Press the ▶ to magnify an image on the projection screen.

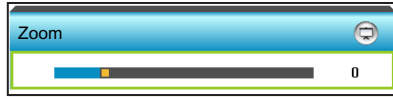

Edge Mask

Edge mask the image to remove video encoding noise on the edge of video source.

- ▶ Press the ◀ to decrease the edge mask in image.
- ▶ Press the ▶ to increase the edge mask in image.

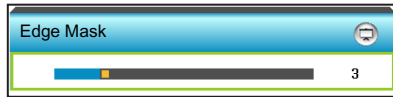

- ❖ Each I/O has different setting of "Edge Mask".
- ❖ "Edge Mask" and "Zoom" can't work at same time.

Image Shift

Press the ▶ into the next menu as below and then press the ▲ or ▼ or ◀ or ▶ to select item.

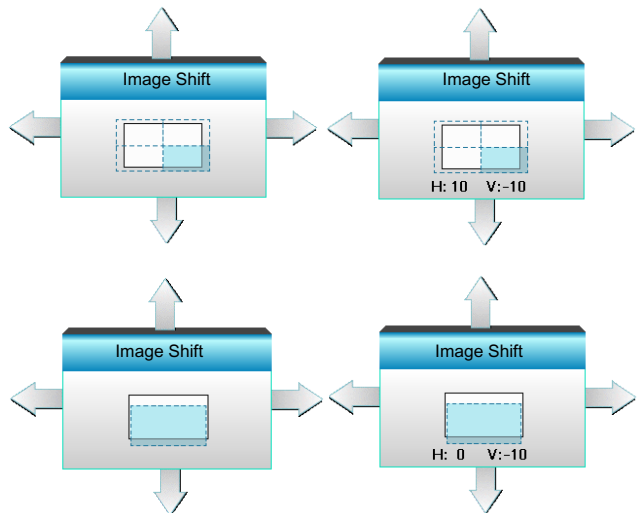

- ▶ H: Press the ◀▶ to shift the projected image position horizontally.
- ▶ V: Press the ▲▼ to shift the projected image position vertically.

User Controls

V Keystone

Press the ◀ or ▶ to adjust image distortion vertically and make a squarer image.

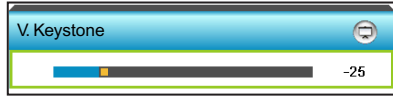

Exit

Choose "Exit" to exit the menu.

DISPLAY | 3D

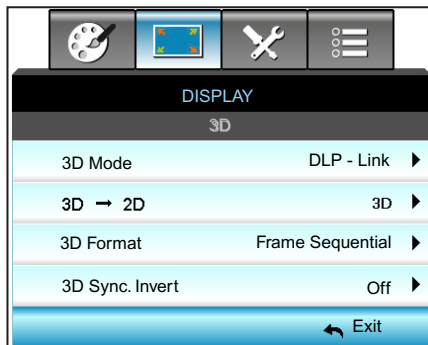

3D Mode

- ▶ Off: Select "Off" to turn off 3D mode.
- ▶ Press the ◀ or ▶ to select the 3D mode.



- ❖ 3D Format is only supported on 3D Timing on page 94.
- ❖ "3D Format" is only supported on non-HDMI 1.4a 3D timing.



- ▶ DLP-Link: Select "DLP-Link" to use optimized settings for DLP Link 3D Glasses. (refer to page 15).
- ▶ VESA 3D: Select "VESA 3D" to use optimized setting for VESA 3D Glasses. (refer to page 15).

3D -> 2D

- ▶ Press the ◀ or ▶ to select 3D -> 2D.

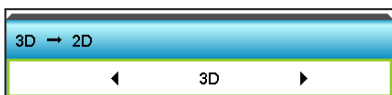

- ▶ 3D: Display 3D signal.
- ▶ L (Left): Display the left frame of 3D content.
- ▶ R (Right): Display the right frame of 3D content.

3D Format

- ▶ Press the ◀ or ▶ to select 3D format.

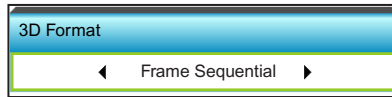

- ▶ Auto: When a 3D identification signal is detected, the 3D format is selected automatically.
- ▶ SBS: Display 3D signal in "Side-by-Side" format.
- ▶ Top and Bottom: Display 3D signal in "Top and Bottom" format.
- ▶ Frame Sequential: Display 3D signal in "Frame Sequential" format.

3D Sync. Invert

- ▶ Press the ◀ or ▶ to select 3D sync. invert.



- ▶ Press the "On" to invert left and right frame contents.
- ▶ Press the "Off" for default frame contents.

Exit

Choose "Exit" to exit the menu.

SETUP

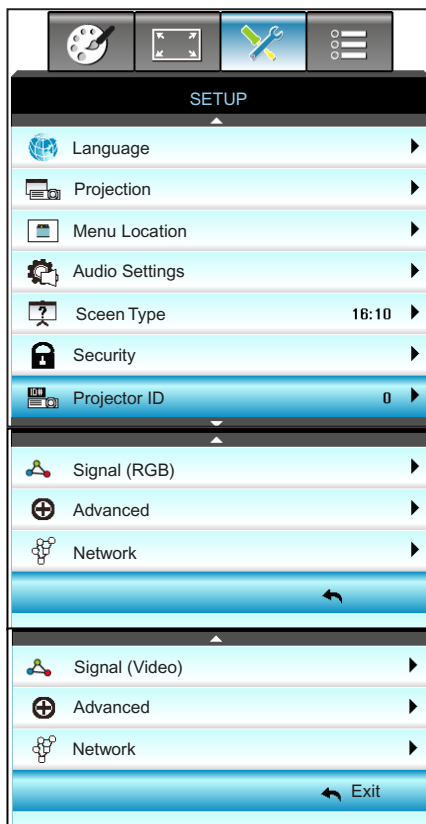

User Controls

Language

Choose the multilingual OSD menu. Press ► into the sub menu and then press the ▲ or ▼ or ◀ or ▶ key to select your preferred language. Press “Enter” to finalize the selection.

Language			
English	Nederlands	Čeština	Türkçe
Deutsch	Norsk/Dansk	عربي	فارسی
Français	Polski	繁體中文	Slovenský
Italiano	Русский	简体中文	Romanian
Español	Suomi	日本語	
Português	ελληνικά	한국어	
Svenska	Magyar	ไทย	← Exit





Projection

Press the ▲ or ▼ or ◀ or ▶ key to select the preferred projection.



- ❖ Rear-Desktop and Rear-Ceiling are to be used with a translucent screen.



- ▶  Front-Projection
This is the default selection. The image is projected straight on the screen.
- ▶  Rear-Desktop
When selected, the image will appear reversed.
- ▶  Front-Ceiling
When selected, the image will turn upside down.
- ▶  Rear-Ceiling
When selected, the image will appear reversed in upside down position

User Controls

Menu Location

Press the ▲ or ▼ or ◀ or ▶ key to select the preferred menu location.

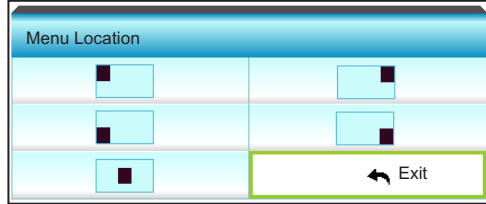

❖ *This screen type applies to WXGA only.

Screen Type

Press the ◀ or ▶ to choose the screen type from 16:10* or 16:9.

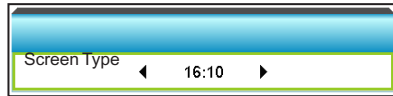

Projector ID

ID definition can be set up by menu (range 0-99), and allow user control an individual projector by RS232.

- ▶ Press the ◀ to decrease the projector ID number.
- ▶ Press the ▶ to increase the projector ID number.

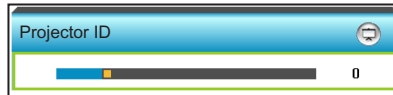

Exit

Choose "Exit" to exit the menu.

SETUP / Audio Settings



- ❖ "Mute" function affects both internal and external speaker volume.

Internal Speaker

Choose the "On" or "Off" to turn on or off the internal speaker.



Mute

- ▶ Choose the "On" to turn mute on.
- ▶ Choose the "Off" to turn mute off.



Volume

- ▶ Press the ◀ to decrease the volume.
- ▶ Press the ▶ to increase the volume.

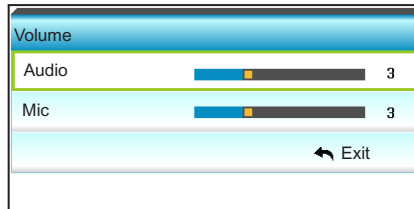

User Controls

Audio Input

The default audio settings are on the back panel of the projector. Use this option to reassign any of the Audio Inputs (1 or 2) to the current image source. Each Audio input can be assigned to more than one video source.

- ▶ Press ◀ or ▶ to select audio input.

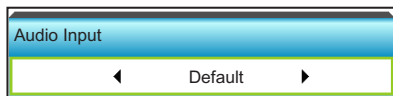

- ▶ Default.
- ▶ Audio 1: (RCA) for Composite
- ▶ Audio 2: (Mini jack) for VGA

Exit

Choose "Exit" to exit the menu.

SETUP | Security



Security

- ▶ On: Choose “On” to use security verification when the turning on the projector.
- ▶ Off: Choose “Off” to be able to switch on the projector without password verification.



Security Timer

Can be select the time (Month/Day/Hour) function to set the number of hours the projector can be used. Once this time has elapsed you will be requested to enter your password again.

Press the ◀ or ▶ to set the month, day, and hour.

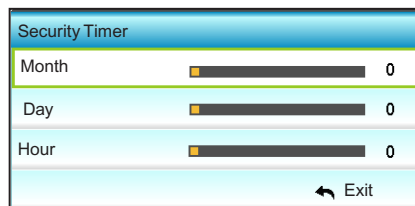

User Controls



- ❖ Pass-code default value is “1234” (first time).

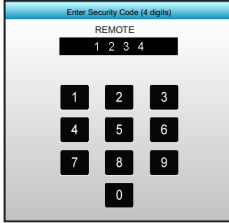

Change Password

- ▶ First time:
 1. Press “Enter” key to set the password.
 2. The password has to be 4 digits.
 3. Use number button on the remote or on-screen numeric keypad to enter your new password and then press “Enter” key to confirm your password.
- ▶ Change Password:

(If your remote does not have a number keypad, please use the up/down arrows to change each digit of the password, then press enter to confirm)

 1. Press “Enter” to input old password.
 2. Use number button or on-screen numeric keypad to enter current password and then press “Enter” to confirm.
 3. Enter new password (4 digits in length) using the number buttons on the remote, then press “Enter” to confirm.
 4. Enter new password again and press “Enter” to confirm.
 - ▶ If the incorrect password is entered 3 times, the projector will automatically shut down.
 - ▶ If you have forgotten your password, please contact your local office for support.

Exit

Choose “Exit” to exit the menu.

SETUP | Network

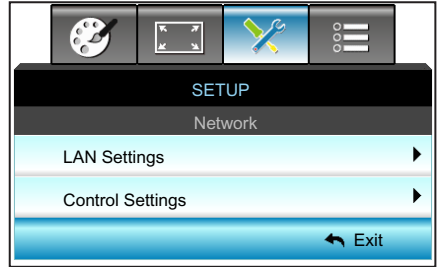

LAN Settings

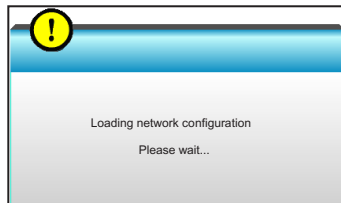

For more information on LAN Settings, refer to page 58-59, and 62-69

Control Settings

For more information on Control Settings, refer to page 60-69.

SETUP / Network/LAN Settings

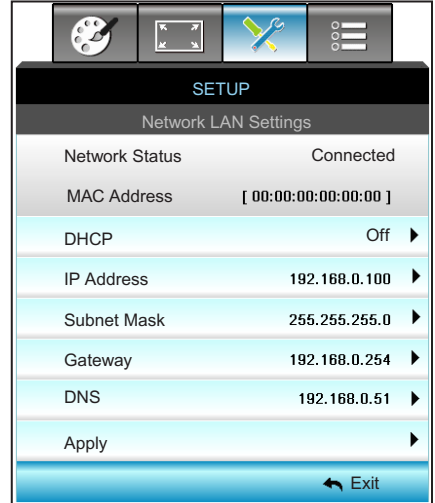

Network Status

Display the network connection status (read-only).

MAC Address

Display the MAC address (read-only).

DHCP



- ▶ On: Projector will obtain an IP address automatically from your network.
- ▶ Off: To assign IP, Subnet Mask, Gateway and DNS configuration manually.

Exiting OSD will automatically apply the entered values.

IP Address

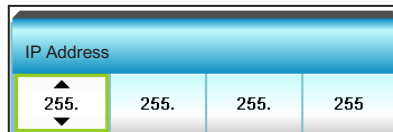

Display the IP address.

User Controls

Subnet Mask



The image shows a configuration window titled "Subnet Mask". It contains four input fields, each displaying the number "255.". The first field is highlighted with a green border and has up and down arrow icons above and below it, indicating it is the active field for editing.

Display subnet mask number.

Gateway

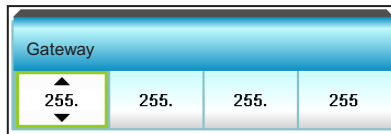

The image shows a configuration window titled "Gateway". It contains four input fields, each displaying the number "255.". The first field is highlighted with a green border and has up and down arrow icons above and below it, indicating it is the active field for editing.

Display the default gateway of the network connected to the projector.

DNS

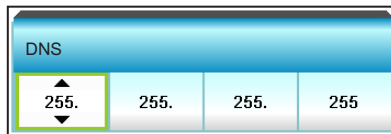

The image shows a configuration window titled "DNS". It contains four input fields, each displaying the number "255.". The first field is highlighted with a green border and has up and down arrow icons above and below it, indicating it is the active field for editing.

Display DNS number.

Apply

Press ► and then choose "Yes" to apply the selection.



The image shows a confirmation window titled "Apply". It contains two buttons: "No" and "Yes". The "No" button is highlighted with a green border.

Exit

Choose "Exit" to exit the menu.

SETUP / Network|Control Settings



Crestron



Use this function to select the network function (port: 41794). For more information, please visit <http://www.crestron.com> and www.crestron.com/getroomview.

- ▶ On: The Crestron function is active.
- ▶ Off: The Crestron function is inactive.

Extron



Use this function to select the network function (port: 2023).

- ▶ On: The Extron function is active.
- ▶ Off: The Extron function is inactive.

PJ Link



Use this function to select the network function (port: 4352).

- ▶ On: The PJ Link function is active.
- ▶ Off: The PJ Link function is inactive.

AMX Device Discovery



Use this function to select the network function (port: 1023).

- ▶ On: The AMX Discovery function is active.
- ▶ Off: The AMX Discovery function is inactive.

Telnet

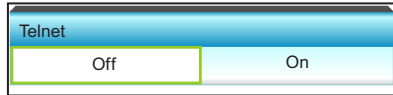

Use this function to select the network function (port: 23).

- ▶ On: Telnet is enabled.
- ▶ Off: Telnet is disabled.

Exit

Choose "Exit" to exit the menu.

User Controls



- ❖ Use Ethernet Normal Cable to connect the projector to LAN.

LAN RJ45 Function

For simplicity and ease of operation, the W320UST projector provides diverse networking and remote management features. The LAN/RJ45 function of the projector through a network, such as remotely manage: Power On/Off, Brightness and Contrast settings. Also, projector status information, such as: Video-Source, Sound-Mute, etc.

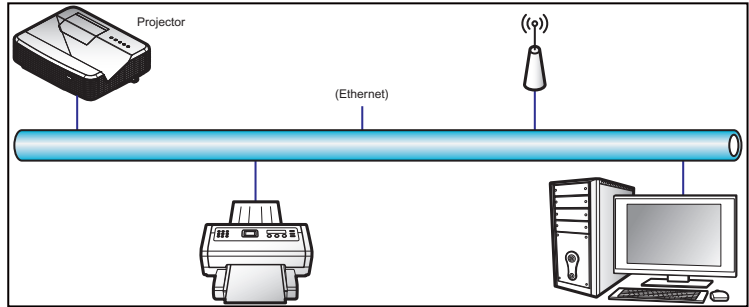

Wired LAN Terminal Functionalities

This projector can be controlled by using a PC (laptop) or other external device via LAN/RJ45 port and compatible with Crestron / Extron / AMX (Device Discovery) / PJLink.

- ▶ Crestron is a registered trademark of Crestron Electronics, Inc. of the United States.
- ▶ Extron is a registered trademark of Extron Electronics, Inc. of the United States.
- ▶ AMX is a registered trademark of AMX LLC of the United States.
- ▶ PJLink applied for trademark and logo registration in Japan, the United States of America, and other countries by JBMIA.

Wired LAN Terminal Functionalities

W320UST projector is supported by the specified commands of the Crestron Electronics controller and related software, for example RoomView®.

<http://www.crestron.com/>

This projector is compliant to support Extron device(s) for reference.

<http://www.extron.com/>

This projector is supported by AMX (Device Discovery).

<http://www.amx.com/>

User Controls

This projector supports all commands of PJLink Class1 (Version 1.00).

<http://pjlink.jbmia.or.jp/english/>

For more detailed information about the various types of external devices which can be connected to the LAN/RJ45 port and remote/control the project, as well as the supported commands for these external devices, please contact the Support-Service directly.

LAN RJ45

1. Connect an RJ45 cable to RJ45 ports on the projector and the PC (laptop).

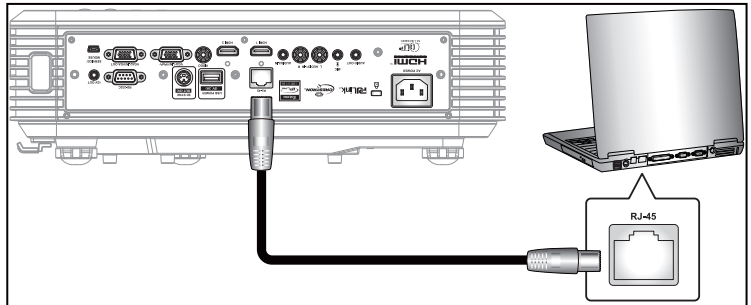

2. On the PC (Laptop), select Start > Control Panel > Network Connections.

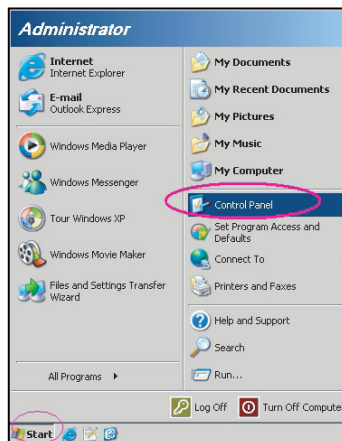

User Controls

3. Right-click on the Local Area Connection, and select Property.

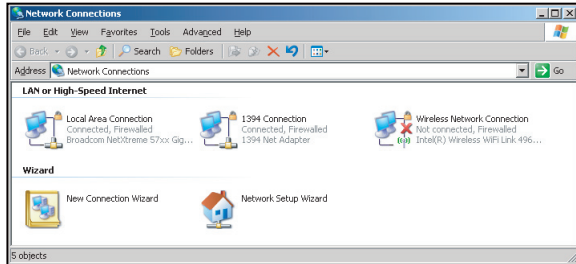

4. In the Properties window, select the General tab, and select Internet Protocol (TCP/IP).

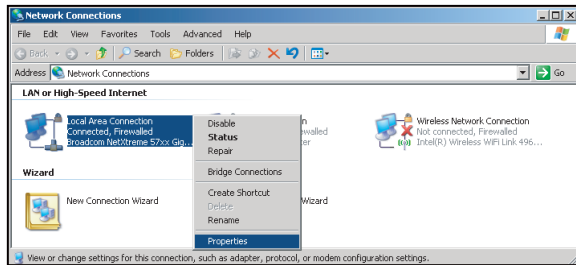

5. Click "Properties".

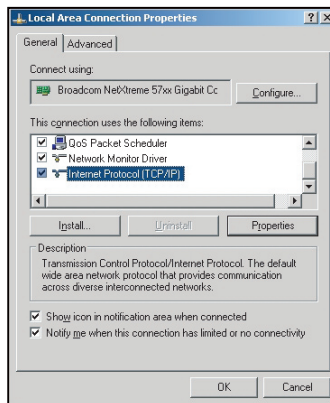

User Controls

6. Type in the IP address and Subnet mask, then press “OK”.

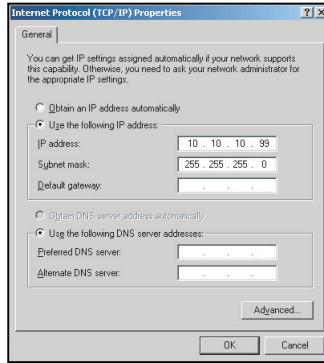

7. Press the “Menu” button on the projector.
8. Use ◀▶ keys to select SETUP > Network > LAN Settings.
9. After getting into LAN Settings, input the following connection parameters:
 - ▶ DHCP: Off
 - ▶ IP Address: 10.10.10.10
 - ▶ Subnet Mask: 255.255.255.255
 - ▶ Gateway: 0.0.0.0
 - ▶ DNS: 0.0.0.0
10. Press “Enter” to confirm settings.
11. Open a web browser, for example Microsoft Internet Explorer, with Adobe Flash Player 9.0 or higher installed.
12. In the Address bar, input the projector’s IP address: 10.10.10.10.

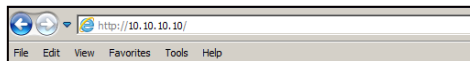

User Controls

13. Press “Enter”.

The projector is setup for remote management. The LAN/RJ45 function displays as follows:

Information Page

The screenshot shows the 'Information Page' of the Optoma projector's web interface. At the top, there is a navigation bar with 'Logout', 'Tools', 'Info', and 'Help' links. The main content area is divided into two columns: 'Projector Information' and 'Projector Status'. The 'Projector Information' column contains fields for Projector Name (EX810ST1), Location (Room), Firmware (B02 2011-09-21), Mac Address (00:50:41:77:31:24), Resolution (0 x 0 Ohz), Lamp Hours (10), and Assigned To (Sir). The 'Projector Status' column contains fields for Power Status (On), Source (HDMI), Preset Mode (Presentation), Projector Position (Front Table), Lamp Mode (STD), and Error Status. An 'exit' button is located at the bottom center of the page.

Main Page

The screenshot shows the 'Main Page' of the Optoma projector's web interface. At the top, there is a navigation bar with 'Tools', 'Info', and 'Help' links. The main content area features a 'SourceList' section with a list of sources: VGA1 (selected), VGA2, Video, HDMI, and Flash Drive. To the right of the source list are control buttons: Menu, AV Mute, and Source, along with directional arrows and an OK button. At the bottom, there is a control bar with buttons for Freeze, Contrast, Brightness, and Color.

User Controls

Tool Page

The screenshot shows the Optoma web interface with the following sections:

- Model:** Optoma
- Navigation:** Logout, Tools, Info, Help
- Optoma Logo:** Optoma
- Creston Control:**
 - IP Address: 192.168.0.2
 - IP ID: 5
 - Port: 41734
 - Send button
- Projector:**
 - Projector Name: EX0108T1
 - Location: Room
 - Name: Sir
 - Send button
- User Password:**
 - Enabled checkbox
 - New Password field
 - Confirm field
 - Send button
- Default Language:**
 - Automatic dropdown
 - Send button
- DHCP:**
 - DHCP Enabled checkbox
- Network Settings:**
 - IP Address: 192.168.0.100
 - Subnet Mask: 255.255.255.0
 - Default Gateway: 192.168.0.254
 - DNS Server: 192.168.0.51
 - Host Name field
 - Send button
- Admin Password:**
 - Enabled checkbox
 - New Password field
 - Confirm field
 - Send button
- Exit:** Exit button

Contact IT Helpdesk

The screenshot shows a "HELP DESK" contact form with the following elements:

- Title: HELP DESK
- Close button: X
- Text input field for the message
- Send button

RS232 by Telnet Function

There is alternative RS232 command control way, in projector so called "RS232 by TELNET" for LAN/RJ45 interface.

User Controls

Quick Start-Guide for "RS232 by Telnet"

- ▶ Check and get the IP address on OSD of the projector.
- ▶ Make sure that the PC/laptop can access the web-page of the projector.
- ▶ Make sure that "Windows Firewall" setting is set disabled in case of "TELNET" function filtering out by PC/laptop.



1. Start > All Programs.> Accessories > Command Prompt.

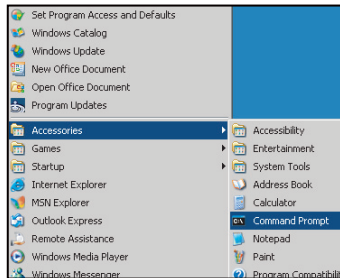

2. Input the command format as follows:
telnet ttt.xxx.yyy.zzz 23 ("Enter" key pressed)
(ttt.xxx.yyy.zzz: IP-Address of the projector)
3. If Telnet-Connection ready, and user can have RS232 command input, then "Enter" key pressed, the RS232 command will be workable.



- ❖ In Windows XP built-in “TELNET.exe” utility, “Enter” key pressed will have “Carriage-Return” and “New-Line” code.

Specification for “RS232 by TELENT”:

1. Telnet:TCP
2. Telnet port: 23 (for more detail, kindly please get contact with the service agent or team).
3. Telnet utility: Windows “TELNET.exe” (console mode).
4. Disconnection for RS232-by-Telnet control normally: Close
5. Windows Telnet utility directly after TELNET connection ready.
 - ▶ Limitation 1 for Telnet-Control: there is less than 50 bytes for successive network payload for Telnet-Control application.
 - ▶ Limitation 2 for Telnet-Control: there is less than 26 bytes for one complete RS232 command for Telnet-Control.
 - ▶ Limitation 3 for Telnet-Control: Minimum delay for next RS232 command must be more than 200 (ms).

SETUP / Signal (RGB)

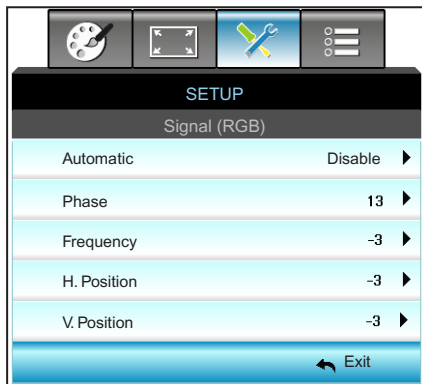

Automatic

- ❖ “Signal” is only supported in Analog VGA (RGB) signal.
- ❖ If “Signal” is automatic, the phase, frequency items are grayed out, and if “Signal” is not automatic, the phase, frequency items will appear for the user to manually tune and are saved in the settings after Phase that for the next time projector is turned off and on again.

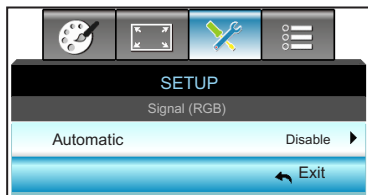

Automatically selects the signal. If you use this function, the Phase, frequency items are grayed out, and if Signal is not automatic, the phase, frequency items will appear for user to manually tune and saved in settings after that for next time projector turns off and on again



Synchronize the signal timing of the display with the graphic card. If the image appears to be unstable or flickers, use this function to correct it.

- ▶ Press the ◀ to decrease the phase value.
- ▶ Press the ▶ to increase the phase value.

Frequency

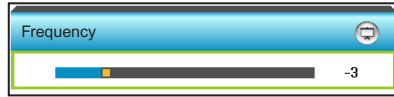

Change the display data frequency to match the frequency of your computer's graphic card. Use this function only if the image appears to flicker vertically.

- ▶ Press the ◀ to decrease the frequency.
- ▶ Press the ▶ to increase the frequency.

H. Position (Horizontal Position)

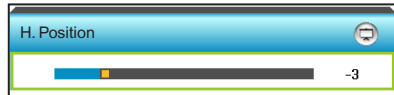

- ▶ Press the ◀ to move the image left.
- ▶ Press the ▶ to move the image right.

V. Position (Vertical Position)

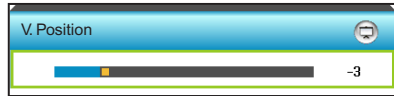

- ▶ Press the ◀ to move the image down.
- ▶ Press the ▶ to move the image up.

Exit

Choose "Exit" to exit the menu.

SETUP / Signal (Video)

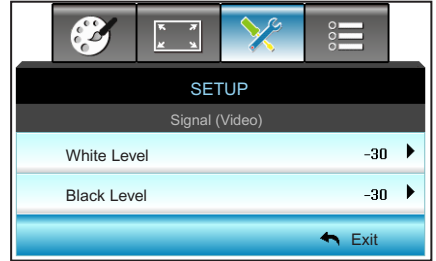

White Level



Adjust the overall white level of the projected image by applying a gain to the input image.

- ▶ Press the ◀ to decrease the white level.
- ▶ Press the ▶ to increase the white level.

Black Level



Adjust the overall black level of the projected image by applying a offset to the input image.

- ▶ Press the ◀ to decrease the black level.
- ▶ Press the ▶ to increase the black level.

Exit

Choose "Exit" to exit the menu.

SETUP / Advanced



Logo



- ❖ For a successful logo capture, ensure that the on-screen image does not exceed the projector native resolution. (1280 x 800).

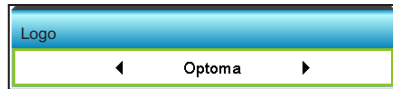

Use this function to set the desired startup screen. If changes are made they will take effect the next time the projector is powered on.

- ▶ Neutral: Logo is not displayed on startup screen.
- ▶ Optoma: Optoma logo is displayed on startup screen.
- ▶ User: User-defined background is shown on startup screen.

Logo Capture

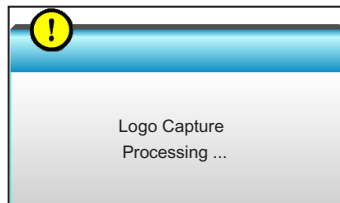
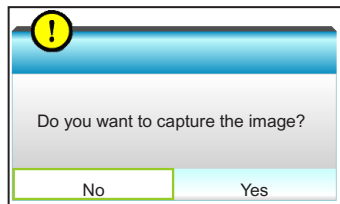

User Controls

Choose “On” and “Yes” to capture an image of the picture currently displayed on screen.

Closed Captioning

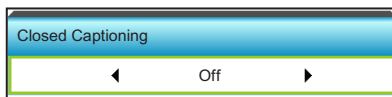

Closed Captioning is a text version of the program sound or other information displayed on the screen. If the input signal contains closed captions, you can turn on the feature and watch the channels. Press ◀ or ▶ to select between CCI, or CC2. Choose Off to disable this function.

Exit

Choose “Exit” to exit the menu.

OPTIONS

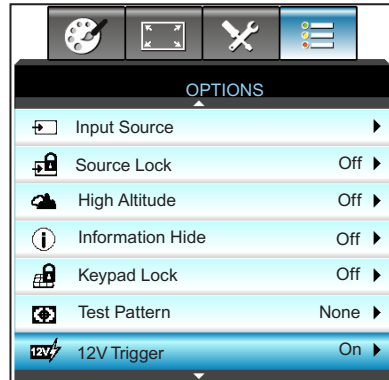

- ❖ “VGA2” depends on the settings of “VGA2 Switch”.

Input Source

Use this option to enable/disable input sources. Press  to enter the sub menu and select which sources you require. Press “Enter” to finalize the selection. The projector will only search for inputs that are enabled.

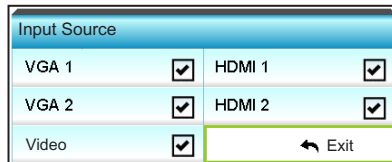

Source Lock

- ▶ On: The projector will only search current input connection.
- ▶ Off: The projector will search for other signals if the current input signal is lost.



High Altitude

When “On” is selected, the fans will spin faster. This feature is useful in high altitude areas where the air is thin.



User Controls

Information Hide

- ▶ On: Choose “On” to hide the info message.
- ▶ Off: Choose “Off” to show the “searching” message.



Keypad Lock

When the keypad lock function is “On”, the Keypad will be locked however, the projector can be operated by the remote control. By selecting “Off”, you will be able to unlock the Keypad.



Test Pattern

Display a test pattern. There are Grid, White Pattern and None.

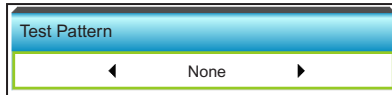

12V Trigger

- ▶ Off: Choose “Off” to disable the trigger.
- ▶ On: Choose “On” to enable the trigger.

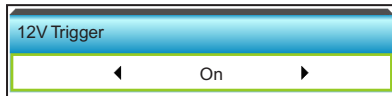

OPTIONS

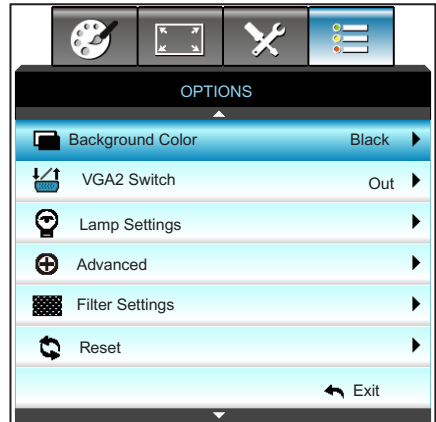

Background Color

Use this feature to display a “Black”, “Red”, “Blue”, “Green” or “White”, screen when no signal is available.



VGA2 Switch

When the “VGA2 Switch” feature is “In” then VGA2 port functions as input port. If the “VGA2 Switch” is “Out” then the port functions as output port for VGA1.



User Controls

Reset

- ▶ Current: Choose “Yes” to return the display parameters on this menu to the factory default settings.
- ▶ All: Choose “Yes” to return the display parameters on all menus to the factory default settings.

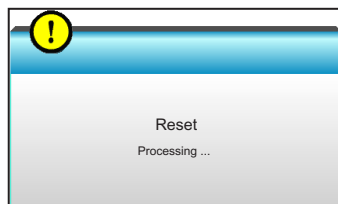
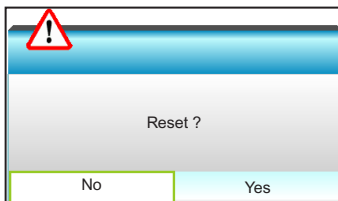

Exit

Choose “Exit” to exit the menu.

OPTIONS / Lamp Settings

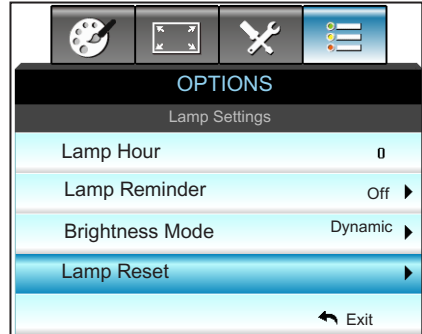

- ❖ When ambient temperature is over 40°C in operating, the projector will switch to Eco automatically.
- ❖ Dynamic mode-lamp power can be dynamically adjusted from 100% to 30%.

Lamp Hours

Display the projection time.

Lamp Reminder

Choose this function to show or to hide the warning message when the changing lamp message is displayed.

The message will appear 30 hours before suggested replacement of lamp.



Brightness Mode

- ▶ Bright: Choose "Bright" to increase the brightness.
- ▶ Eco.: Choose "Eco." to dim the projector lamp which will lower power consumption and extend the lamp life.
- ▶ Dynamic: Choose "Dynamic" to dim the lamp power which will be based on brightness level of the content and adjust lamp power consumption between 100% and 30% dynamically. The lamp life will be extended.
- ▶ Eco+: When Eco+ mode is activated, the brightness level of the content is automatically detected to significantly reduced lamp power consumption (up to 70%) during periods of inactivity.

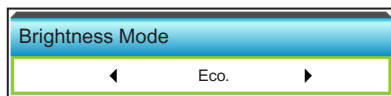

User Controls

Lamp Reset

Resets the lamp hour counter after replacing the lamp.

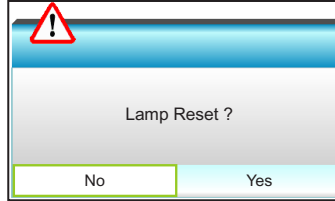

Exit

Choose "Exit" to exit the menu.

Lamp Behavior in different mode and function:

Brightness Mode	Bright	Eco	Dynamic	Eco+
White Pattern	100%	80%	100%	80%
Dimming range	N/A	N/A	100%~30%	80%~30%
Black Pattern	100%	80%	30% (Sleep mode)	30% (Sleep mode)
AV Mute	30% (Sleep mode)	30% (Sleep mode)	30% (Sleep mode)	30% (Sleep mode)
Quick Resume	30% (Sleep mode)	30% (Sleep mode)	30% (Sleep mode)	30% (Sleep mode)

OPTIONS / Advanced

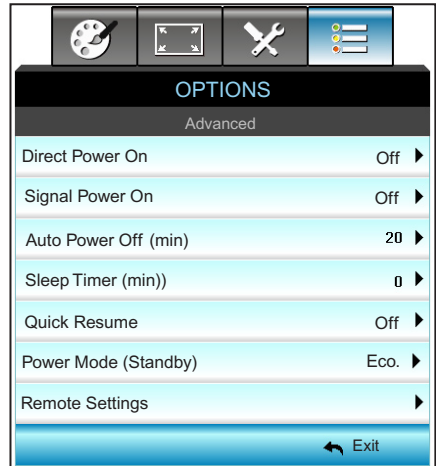

Direct Power On

Choose "On" to activate Direct Power mode. The projector will automatically power on when AC power is supplied, without pressing the "⏻" key on the projector Control Panel or on the remote control.



- ❖ The Signal Power On function is not applicable if the input source is Video.

Signal Power On

Choose "On" to activate Signal Power mode. The projector will automatically power on when a signal is detected, without pressing the "⏻" key on the projector Control Panel or on the remote control.



User Controls



- ❖ The value of sleep timer will be reset to zero after the projector power off.

Auto Power Off (min)

Sets the countdown timer interval. The countdown timer will start, when there is no signal being sent to the projector. The projector will automatically power off when the countdown has finished (in minutes).

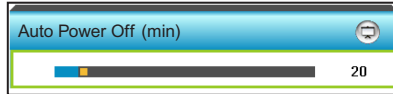

- ▶ Press the ◀ to decrease the timer interval.
- ▶ Press the ▶ to increase the timer interval.

Sleep Timer (min)

Sets the countdown timer interval. The countdown timer will start, with or without a signal being sent to the projector. The projector will automatically power off when the countdown has finished (in minutes).

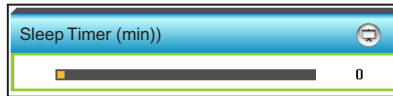

- ▶ Press the ◀ to decrease the timer interval.
- ▶ Press the ▶ to increase the timer interval.

Quick Resume

- ▶ On: If the projector is accidentally turned off, this feature allows the projector to be instantly powered on again, if selected within a period of 100 seconds.
- ▶ Off: The fan will start cooling the system after 10 seconds when user turns off the projector.



Power Mode (Standby)

- ▶ Eco.: Choose "Eco." to save power dissipation further < 0.5W.
- ▶ Active: Choose "Active" to return to normal standby.

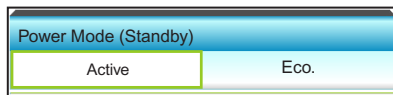

Exit

Choose "Exit" to exit the menu.

OPTIONS | Remote Settings

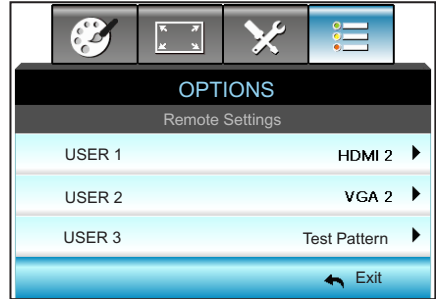

USER 1

The default value is HDMI2.



Press the ▶ into the next menu and then press the ◀ or ▶ to select HDMI2/VGA2/Test Pattern/LAN/Brightness/Contrast/Sleep Timer/ Color Matching/Color Temp/Gamma/ Source Lock /Projection/Lamp Settings/Zoom/Freeze.

USER 2

The default value is VGA2.



Press the ▶ into the next menu and then press the ◀ or ▶ to select HDMI2/VGA2/Test Pattern/LAN/Brightness/Contrast/Sleep Timer/ Color Matching/Color Temp/Gamma/ Source Lock /Projection/Lamp Settings/Zoom/Freeze.

USER 3

The default value is Test Pattern.



Press the ▶ into the next menu and then press the ◀ or ▶ to select HDMI2/VGA2/Test Pattern/LAN/Brightness/Contrast/Sleep Timer/ Color Matching/Color Temp/Gamma/ Source Lock /Projection/Lamp Settings/Zoom/Freezen.

OPTIONS | Filter Settings

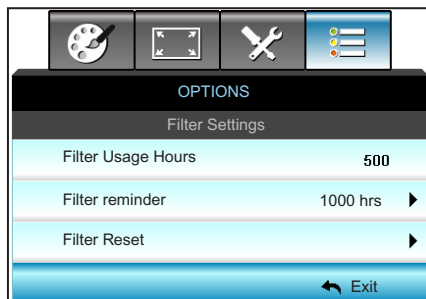

- ❖ "Filter Usage Hours / Filter Reminder / Filter Reset" will only appear when "Optional Filter Installed" is "Yes".

Filter Usage Hours

Display the filter time.

Filter Reminder

Choose this function to show or hide the warning message when the changing filter message is displayed. (Factory default setting: 1000 hours)

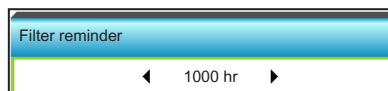

- ▶ Press the ◀ to decrease the time period.
- ▶ Press the ▶ to increase the time period.

Filter Reset

Reset the dust filter counter after replacing or cleaning the dust filter.



Exit

Choose "Exit" to exit the menu.

Troubleshooting

If you experience a problem with your projector, please refer to the following information. If a problem persists, please contact your local reseller or service center.

Image Problems

? No image appears on-screen

- ▶ Ensure all the cables and power connections are correctly and securely connected as described in the “Installation” section.
- ▶ Ensure the pins of connectors are not crooked or broken.
- ▶ Check if the projection lamp has been securely installed. Please refer to the “Replacing the Lamp” section.
- ▶ Make sure the projector is switched on.
- ▶ Ensure that the “AV Mute” feature is not turned on.

? Image is out of focus

- ▶ Make sure the projection screen is between the required distance from the projector. (refer to pages 19-22)

? The image is stretched when displaying 16:9 DVD title

- ▶ When you play anamorphic DVD or 16:9 DVD, the projector will show the best image in 16: 9 format on projector side.
- ▶ If you play the LBX format DVD title, please change the format as LBX in projector OSD.
- ▶ If you play 4:3 format DVD title, please change the format as 4:3 in projector OSD.
- ▶ If the image is still stretched, you will also need to adjust the aspect ratio by referring to the following:
- ▶ Please setup the display format as 16:9 (wide) aspect ratio type on your DVD player.

? Image is too small or too large

- ▶ Move the projector closer to or further from the screen.
- ▶ Press “Menu” on the projector panel, go to “Display-->Format”. Try the different settings.

Image has slanted sides:

- ▶ If possible, reposition the projector so that it is centered on the screen and below the bottom of the screen.
- ▶ Use “Display-->V Keystone” from the OSD to make an adjustment.

Image is reversed

- ▶ Select “Setup-->Projection” from the OSD and adjust the projection direction.

Blurry double image

- ▶ Press “3D Format” button and switch to “Off” to avoid normal 2D image is blurry double image.

Two images, side-by-side format

- ▶ Press “3D Format” button and switch to “SBS” for input signal is HDMI 1.3 2D 1080i side-by-side.

Image does not display in 3D

- ▶ Check if the battery of 3D glasses is drained.
- ▶ Check if the 3D glasses is turned on.
- ▶ When the input signal is HDMI 1.3 2D (1080i side-by-side half), press “3D Format” button and switch to “SBS”.

Other Problems

The projector stops responding to all controls

- ▶ If possible, turn off the projector, then unplug the power cord and wait at least 20 seconds before reconnecting power.

Lamp burns out or makes a popping sound





- ▶ When the lamp reaches its end of life, it will burn out and may make a loud popping sound. If this happens, the projector will not turn on until the lamp module has been replaced. To replace the lamp, follow the procedures in the “Replacing the Lamp” section.

Remote Control Problems

If the remote control does not work

- ▶ Check the operating angle of the remote control is within ± 15 both horizontally and vertically of one of the IR receivers on the projector.
- ▶ Make sure there are not any obstructions between the remote control and the projector. Move to within 6 m (20 ft) of the projector.
- ▶ Make sure batteries are inserted correctly.
- ▶ Replace batteries if they are exhausted.

LED Lighting Messages

Message			
	Power LED (Red/Green/Blue)	Temp-LED (Red)	Lamp-LED (Red)
Standby state (Input power cord)	Red	○	○
Power on (Warm- ing)	Flashing Blue	○	○
Lamp lighting	Blue	○	○
Power off (Cooling)	Flashing Blue. Red (cooling fan has turned off)	○	○
Quick Resume (100 secs)	Flashing Blue	○	○
Error (Over temp.)	Flashing Red		○
Error (Fan failure)	Flashing Red	Flashing	
Error (Lamp failure)	Flashing Red		



❖ Steady light ⇨ 
No light ⇨ ○

On Screen Messages

❖ Power off:

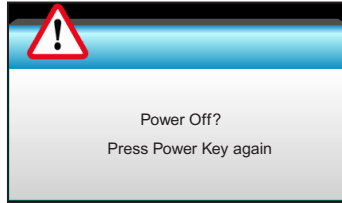

❖ Lamp warning:

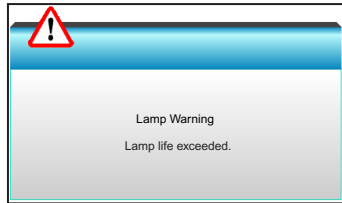

❖ Temperature warning:

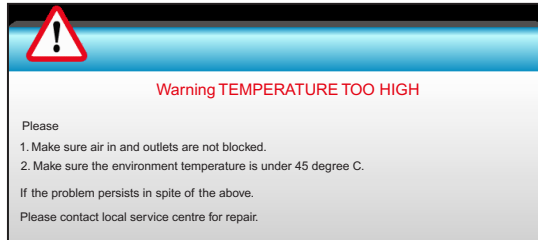

❖ Fan failed:

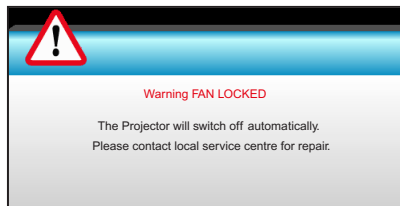

❖ Out of display range:

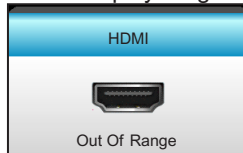

Replacing the Lamp

The projector automatically detects the lamp life. When the lamp life is nearing the end of use, you will receive a warning message.

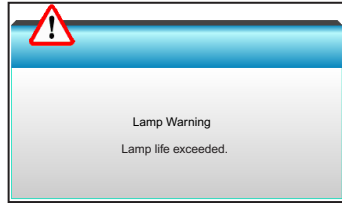

When you see this message, please contact your local reseller or service center to change the lamp as soon as possible. Make sure the projector has been cooled down for at least 30 minutes before changing the lamp.



Warning: If ceiling mounted, please use caution when opening the lamp access panel. It is recommended to wear safety glasses if changing the bulb when ceiling mounted. "Caution must be used to prevent any loose parts from falling out of projector."



Warning: Lamp compartment is hot! Allow it to cool down before changing lamp!



Warning: To reduce the risk of personal injury, do not drop the lamp module or touch the lamp bulb. The bulb may shatter and cause injury if it is dropped.

NOTE

- ❖ The screw on the lamp cover and the lamp cannot be removed.
- ❖ The projector cannot be turned on if the lamp cover has not been placed back on the projector.
- ❖ Do not touch the glass area of the lamp. Hand oil can cause the lamp to shatter. Use a dry cloth to clean the lamp module if it was accidentally touched.

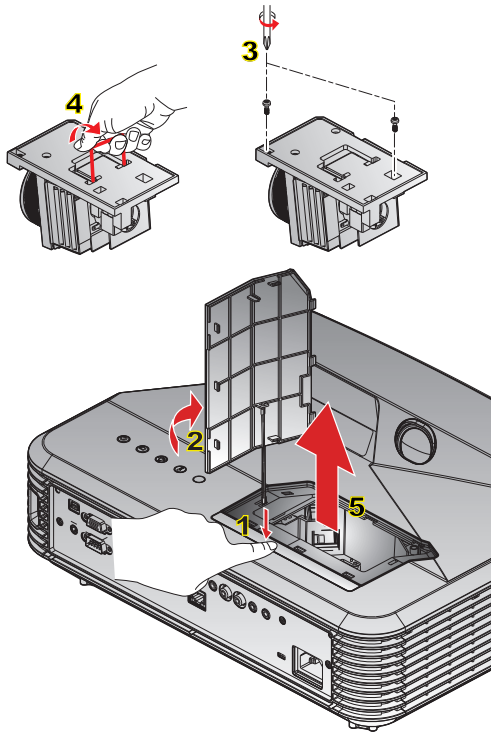

Lamp Replacement Procedure:

1. Switch off the power to the projector by pressing the “**⏻**” button on the remote control or on the Control Panel of the projector.
 2. Allow the projector to cool down for at least 30 minutes.
 3. Disconnect the power cord.
 4. Press the release button to disengage the lamp cover from the main unit. **1**
 5. Use your fingernail to pry the lamp cover loose and then remove it. **2**
 6. Unscrew the two screws on the lamp module. **3**
 7. Lift up the lamp handle **4** and remove the lamp module slowly and carefully. **5**
- To replace the lamp module, reverse the previous steps.
10. Turn on the projector and reset the lamp timer.

Lamp Reset: (i) Press “Menu” → (ii) Select “OPTIONS” → (iii) Select “Lamp Settings” → (iv) Select “Lamp Reset” → (v) Select “Yes”.

Installing and Cleaning the Dust Filter



- ❖ Dust filters are only required/supplied in selected regions with excessive dust.

We recommend you clean the dust filter every 500 hours of operation, or more often if you are using the projector in a dusty environment.

When the warning message appears on the screen, do the following to clean the air filter:

The usage time of the dust filter is reached.
Please clean the dust filters for better performance.

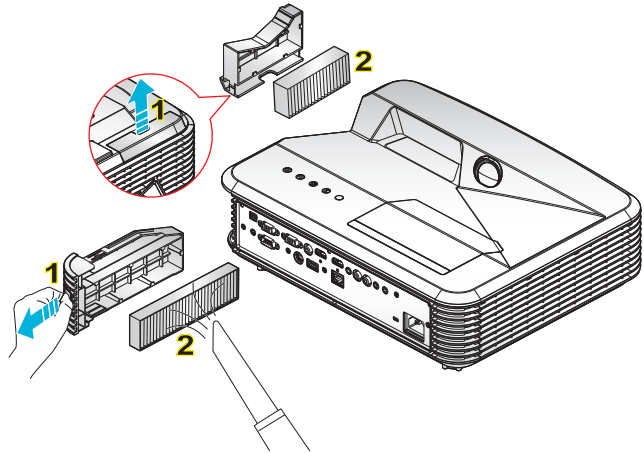

○ Air Filter Cleaning Procedure:

1. Switch off the power to the projector by pressing the “” button on the remote control or on the Control Panel of the projector.
2. Disconnect the power cord.
3. Pull out the latch to remove the dust filter compartment, as shown in the illustration. **1**
4. Carefully remove the air filter. Then clean or replace the dust filter. **2**
To install the dust filter, reverse the previous steps.
5. Turn on the projector and reset the filter usage counter after the dust filter is replaced.

Compatibility Modes

HDMI Compatibility

Digital		
B0/Established timing	B0/Standard timing	B0/Detail timing:
720 x 400 @ 70Hz 640 x 480 @ 60Hz 640 x 480 @ 67Hz 640 x 480 @ 72Hz 640 x 480 @ 75Hz 800 x 600 @ 56Hz 800 x 600 @ 60Hz 800 x 600 @ 72Hz 800 x 600 @ 75Hz 1024 x 768 @ 60Hz 1024 x 768 @ 70Hz 1024 x 768 @ 75Hz 1280 x 1024 @ 75Hz	XGA / WXGA 1440 x 900 @60Hz 1024 x 768 @120Hz 1280 x 800 @60Hz 1280 x 1024 @60Hz 1680 x 1050 @60Hz 1280 x 720 @60Hz 1280 x 720 @120Hz 1600 x 1200 @60Hz 1080P 1280 x 720 @ 60Hz 1280 x 800 @ 60Hz 1280 x1024 @ 60Hz 1400 x 1050 @ 60Hz 1600 x 1200 @ 60Hz 1440 x 900 @60Hz	Native timing: XGA: 1024 x 768 @60Hz WXGA: 1280 x 800 @60Hz 1080P: 1920 x 1080 @60Hz
B1/Video mode	B1/Detail timing:	
640 x 480p @ 60Hz 720 x 480p @ 60Hz 1280 x 720p @ 60Hz 1920 x 1080i @ 60Hz 720(1440) x 480i @ 60Hz 1920 x 1080p @ 60Hz 720 x 576p @ 50Hz 1280 x 720p @ 50Hz 1920 x 1080i @ 50Hz 720(1440) x 576i @ 50Hz 1920 x 1080p @ 50Hz 1920 x 1080p @ 24Hz 1920 x 1080p @ 30Hz	720 x 480p @ 60Hz 1280 x 720p @ 60Hz 1366 x 768 @ 60Hz 1920 x 1080i @ 50Hz 1920 x 1080p @ 60Hz	

True 3D Video Compatibility

Input resolution	Input timing		
HDMI 1.4b 3D Input	1280 x 720p @ 50Hz	Top-and-Bottom	
	1280 x 720p @ 60Hz	Top-and-Bottom	
	1280 x 720p @ 50Hz	Frame packing	
	1280 x 720p @ 60Hz	Frame packing	
	1920 x 1080i @ 50 Hz	Side-by-Side (Half)	
	1920 x 1080i @ 60 Hz	Side-by-Side (Half)	
	1920 x 1080p @ 24 Hz	Top-and-Bottom	
	1920 x 1080p @ 24 Hz	Frame packing	
HDMI 1.3	1920 x 1080i @ 50Hz	Side-by-Side (Half)	While 3D Format is "SBS"
	1920 x 1080i @ 60Hz		
	1280 x 720p @ 50Hz		
	1280 x 720p @ 60Hz		
	1920 x 1080i @ 50Hz	Top-and-Bottom	While 3D Format is "Top and Bottom"
	1920 x 1080i @ 60Hz		
	1280 x 720p @ 50Hz		
	1280 x 720p @ 60Hz		
	480i	HQFS	While 3D Format is "Frame sequential"

RS232 Commands and Protocol Function List

RS232 Pin Assignments

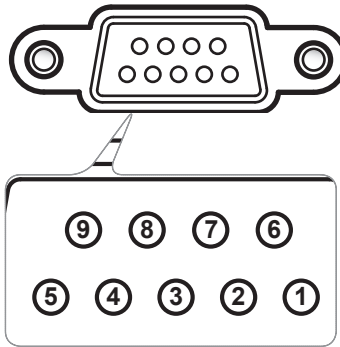

- ❖ RS232 shell is grounded.

Pin no.	Spec. (from projector side)
1	N/A
2	RXD
3	TXD
4	N/A
5	GND
6	N/A
7	N/A
8	N/A
9	N/A

Appendices

RS232 Protocol Function List



1. There is a <CR> after all ASCII commands.
2. 0D is the HEX code for <CR> in ASCII code.

Baud Rate : 9600
 Data Bits : 8
 Parity : None
 Stop Bits : 1
 Flow Control : None
 UART16550 FIFO: Disable
 Projector Return (Pass): P
 Projector Return (Fail): F

XX=01-99, projector's ID, XX=00 is for all projectors

SEND to projector				
232 ASCII Code	HEX Code	Function	Description	
~XX00 1	7E 30 30 30 30 20 31 0D	Power ON		
~XX00 0	7E 30 30 30 30 20 30 0D	Power OFF	(0/2 for backward compatible)	
~XX00 1 ~nnnn	7E 30 30 30 30 20 31 20 a 0D	Power ON with Password	~nnnn = ~00000 (a=7E 30 30 30 30 30) ~99999 (a=7E 39 39 39 39 39)	
~XX01 1	7E 30 30 30 31 20 31 0D	Resync		
~XX02 1	7E 30 30 30 32 20 31 0D	AV Mute	On	
~XX02 0	7E 30 30 30 32 20 30 0D		Off (0/2 for backward compatible)	
~XX03 1	7E 30 30 30 33 20 31 0D	Mute	On	
~XX03 0	7E 30 30 30 33 20 30 0D		Off (0/2 for backward compatible)	
~XX04 1	7E 30 30 30 34 20 31 0D	Freeze		
~XX04 0	7E 30 30 30 34 20 30 0D	Unfreeze	(0/2 for backward compatible)	
~XX05 1	7E 30 30 30 35 20 31 0D	Zoom Plus		
~XX06 1	7E 30 30 30 36 20 31 0D	Zoom Minus		
~XX12 1	7E 30 30 31 32 20 31 0D	Direct Source Commands	HDMI1	
~XX12 15	7E 30 30 31 32 20 31 35 0D		HDMI2	
~XX12 5	7E 30 30 31 32 20 35 0D		VGA1	
~XX12 6	7E 30 30 31 32 20 36 0D		VGA 2	
~XX12 8	7E 30 30 31 32 20 38 0D		VGA1 Component	
~XX12 10	7E 30 30 31 32 20 31 30 0D		Video	
~XX20 1	7E 30 30 32 30 20 31 0D		Display Mode	Presentation
~XX20 2	7E 30 30 32 30 20 32 0D			Bright
~XX20 3	7E 30 30 32 30 20 33 0D			Movie
~XX20 4	7E 30 30 32 30 20 34 0D			sRGB
~XX20 5	7E 30 30 32 30 20 35 0D	User		
~XX20 7	7E 30 30 32 30 20 37 0D	Blackboard		
~XX20 13	7E 30 30 32 30 20 31 33 0D	DICOM SIM.		
~XX20 9	7E 30 30 32 30 20 39 0D	3D		
~XX21 n	7E 30 30 32 31 20 a 0D	Brightness		n = -50 (a=2D 35 30) ~ 50 (a=35 30)
~XX22 n	7E 30 30 32 32 20 a 0D	Contrast	n = -50 (a=2D 35 30) ~ 50 (a=35 30)	
~XX23 n	7E 30 30 32 33 20 a 0D	Sharpness	n = 1 (a=31) ~ 15 (a=31 35)	
~XX44 n	7E 30 30 34 34 20 a 0D	Tint	n = -50 (a=2D 35 30) ~ 50 (a=35 30)	
~XX45 n	7E 30 30 34 35 20 a 0D	Color	n = -50 (a=2D 35 30) ~ 50 (a=35 30)	

Appendices

~XX327 n	7E 58 58 33 32 37 20 a 0D	Color Matching	Red Hue	n = -50 (a=2D 35 30) ~ 50 (a=35 30)	
~XX328 n	7E 58 58 33 32 38 20 a 0D		Green Hue	n = -50 (a=2D 35 30) ~ 50 (a=35 30)	
~XX329 n	7E 58 58 33 32 39 20 a 0D		Blue Hue	n = -50 (a=2D 35 30) ~ 50 (a=35 30)	
~XX330 n	7E 58 58 33 33 30 20 a 0D		Cyan Hue	n = -50 (a=2D 35 30) ~ 50 (a=35 30)	
~XX331 n	7E 58 58 33 33 31 20 a 0D		Yellow Hue	n = -50 (a=2D 35 30) ~ 50 (a=35 30)	
~XX332 n	7E 58 58 33 33 32 20 a 0D		Magenta Hue	n = -50 (a=2D 35 30) ~ 50 (a=35 30)	
~XX333 n	7E 58 58 33 33 33 20 a 0D		Red Saturation	n = -50 (a=2D 35 30) ~ 50 (a=35 30)	
~XX334 n	7E 58 58 33 33 34 20 a 0D		Green Saturation	n = -50 (a=2D 35 30) ~ 50 (a=35 30)	
~XX335 n	7E 58 58 33 33 35 20 a 0D		Blue Saturation	n = -50 (a=2D 35 30) ~ 50 (a=35 30)	
~XX336 n	7E 58 58 33 33 36 20 a 0D		Cyan Saturation	n = -50 (a=2D 35 30) ~ 50 (a=35 30)	
~XX337 n	7E 58 58 33 33 37 20 a 0D		Yellow Saturation	n = -50 (a=2D 35 30) ~ 50 (a=35 30)	
~XX338 n	7E 58 58 33 33 38 20 a 0D		Magenta Saturation	n = -50 (a=2D 35 30) ~ 50 (a=35 30)	
~XX339 n	7E 58 58 33 33 39 20 a 0D		Red Gain	n = -50 (a=2D 35 30) ~ 50 (a=35 30)	
~XX340 n	7E 58 58 33 34 30 20 a 0D		Green Gain	n = -50 (a=2D 35 30) ~ 50 (a=35 30)	
~XX341 n	7E 58 58 33 34 31 20 a 0D	Blue Gain	n = -50 (a=2D 35 30) ~ 50 (a=35 30)		
~XX342 n	7E 58 58 33 34 32 20 a 0D	Cyan Gain	n = -50 (a=2D 35 30) ~ 50 (a=35 30)		
~XX343 n	7E 58 58 33 34 33 20 a 0D	Yellow Gain	n = -50 (a=2D 35 30) ~ 50 (a=35 30)		
~XX344 n	7E 58 58 33 34 34 20 a 0D	Magenta Gain	n = -50 (a=2D 35 30) ~ 50 (a=35 30)		
~XX345 n	7E 58 58 33 34 35 20 a 0D	White/R	n = -50 (a=2D 35 30) ~ 50 (a=35 30)		
~XX346 n	7E 58 58 33 34 36 20 a 0D	White/G	n = -50 (a=2D 35 30) ~ 50 (a=35 30)		
~XX347 n	7E 58 58 33 34 37 20 a 0D	White/B	n = -50 (a=2D 35 30) ~ 50 (a=35 30)		
~XX215 1	7E 30 30 32 31 35 20 31 0D		Reset		
~XX24 n	7E 30 30 32 34 20 a 0D	RGB Gain/Bias	Red Gain	n = -50 (a=2D 35 30) ~ 50 (a=35 30)	
~XX25 n	7E 30 30 32 35 20 a 0D		Green Gain	n = -50 (a=2D 35 30) ~ 50 (a=35 30)	
~XX26 n	7E 30 30 32 36 20 a 0D		Blue Gain	n = -50 (a=2D 35 30) ~ 50 (a=35 30)	
~XX27 n	7E 30 30 32 37 20 a 0D		Red Bias	n = -50 (a=2D 35 30) ~ 50 (a=35 30)	
~XX28 n	7E 30 30 32 38 20 a 0D		Green Bias	n = -50 (a=2D 35 30) ~ 50 (a=35 30)	
~XX29 n	7E 30 30 32 39 20 a 0D		Blue Bias	n = -50 (a=2D 35 30) ~ 50 (a=35 30)	
~XX33 n	7E 30 30 33 33 20 a 0D			Reset	
~XX34 n	7E 30 30 33 34 20 a 0D		BrilliantColor™		n = 1 (a=31) ~ 10 (a=31 30)
~XX196 n	7E 30 30 31 39 36 20 a 0D		Noise Reduction		n = 1 (a=31) ~ 10 (a=31 30)
~XX35 1	7E 30 30 33 35 20 31 0D		Gamma	Film	
~XX35 3	7E 30 30 33 35 20 33 0D	Graphics			
~XX35 5	7E 30 30 33 35 20 35 0D			1.8	
~XX35 6	7E 30 30 33 35 20 36 0D			2.0	
~XX35 7	7E 30 30 33 35 20 37 0D			2.2	
~XX35 8	7E 30 30 33 35 20 38 0D			2.6	
~XX35 9	7E 30 30 33 35 20 39 0D			3D	
~XX36 0	7E 30 30 33 36 20 31 0D	Color Temp.		Medium	
~XX36 1	7E 30 30 33 36 20 32 0D			Cool	
~XX36 2	7E 30 30 33 36 20 33 0D		Cold		
~XX37 1	7E 30 30 33 37 20 31 0D	Color Space	Auto		
~XX37 2	7E 30 30 33 37 20 32 0D		RGB\ RGB(0-255)		
~XX37 3	7E 30 30 33 37 20 33 0D		YUV		
~XX37 4	7E 30 30 33 37 20 34 0D		RGB(16 - 235)		

Appendices

~XX73 n	7E 30 30 37 33 20 a 0D	Signal (RGB)	Frequency	n = -5 (a=2D 35) ~ 5 (a=35) By signal
~XX74 n	7E 30 30 37 34 20 a 0D		Phase	n = 0 (a=30) ~ 31 (a=33 31) By signal
~XX91 1	7E 30 30 39 31 20 31 0D	Automatic	Enable	
~XX91 0	7E 30 30 39 31 20 30 0D		Disable	
~XX75 n	7E 30 30 37 35 20 a 0D		H. Position	n = -5 (a=2D 35) ~ 5 (a=35) By timing
~XX76 n	7E 30 30 37 36 20 a 0D		V. Position	n = -5 (a=2D 35) ~ 5 (a=35) By timing
~XX200 n	7E 30 30 32 30 30 20 a 0D	Signal (Video)	White Level	
~XX201 n	7E 30 30 32 30 31 20 a 0D		Black Level	
~XX204 1	7E 30 30 32 30 30 21 31 0D		0	
~XX204 0	7E 30 30 32 30 30 21 30 0D		7.5	
~XX60 1	7E 30 30 36 30 20 31 0D	Format	4:3	
~XX60 2	7E 30 30 36 30 20 32 0D		16:9	
~XX60 3	7E 30 30 36 30 20 33 0D		16:10(WXGA Model)	
~XX60 5	7E 30 30 36 30 20 35 0D		LBX	
~XX60 6	7E 30 30 36 30 20 36 0D		Native	
~XX60 7	7E 30 30 36 30 20 37 0D		Auto	
~XX62 n	7E 30 30 36 32 20 a 0D	Digital Zoom	Zoom	n = -5 (a=2D 35) ~ 25 (a=32 35)
~XX61 n	7E 30 30 36 31 20 a 0D	Edge mask		n = 0 (a=30) ~ 10 (a=31 30)
~XX63 n	7E 30 30 36 33 20 a 0D	H Image Shift		n = -100 (a=2D 31 30 30) ~ 100 (a=31 30 30)
~XX64 n	7E 30 30 36 34 20 a 0D	V Image Shift		n = -100 (a=2D 31 30 30) ~ 100 (a=31 30 30)
~XX66 n	7E 30 30 36 36 20 a 0D	V Keystone		n = -40 (a=2D 34 30) ~ 40 (a=34 30)
~XX230 1	7E 30 30 32 33 30 20 31 0D	3D Mode	DLP-Link	
~XX230 3	7E 30 30 32 33 30 20 33 0D		VESA	
~XX230 0(or2) 7E	30 30 32 33 30 20 30(32) 0D		Off	
~XX400 0	7E 30 30 34 30 30 20 30 0D	3D->2D	3D	
~XX400 1	7E 30 30 34 30 30 20 31 0D		L	
~XX400 2	7E 30 30 34 30 30 20 32 0D		R	
~XX405 0	7E 30 30 34 30 35 20 30 0D	3D Format	Auto	
~XX405 1	7E 30 30 34 30 35 20 31 0D		SBS	
~XX405 2	7E 30 30 34 30 35 20 32 0D		Top and Bottom	
~XX405 3	7E 30 30 34 30 35 20 33 0D		Frame sequential	
~XX231 0	7E 30 30 32 33 31 20 30 0D	3D Sync Invert	On	
~XX231 1	7E 30 30 32 33 31 20 31 0D		Off	
~XX70 1	7E 30 30 37 30 20 31 0D	Language	English	
~XX70 2	7E 30 30 37 30 20 32 0D		German	
~XX70 3	7E 30 30 37 30 20 33 0D		French	
~XX70 4	7E 30 30 37 30 20 34 0D		Italian	
~XX70 5	7E 30 30 37 30 20 35 0D		Spanish	
~XX70 6	7E 30 30 37 30 20 36 0D		Portuguese	
~XX70 7	7E 30 30 37 30 20 37 0D		Polish	
~XX70 8	7E 30 30 37 30 20 38 0D		Dutch	
~XX70 9	7E 30 30 37 30 20 39 0D		Swedish	
~XX70 10	7E 30 30 37 30 20 31 30 0D		Norwegian/Danish	
~XX70 11	7E 30 30 37 30 20 31 31 0D		Finnish	
~XX70 12	7E 30 30 37 30 20 31 32 0D		Greek	
~XX70 13	7E 30 30 37 30 20 31 33 0D		Traditional Chinese	
~XX70 14	7E 30 30 37 30 20 31 34 0D		Simplified Chinese	

Appendices

~XX70 15	7E 30 30 37 30 20 31 35 0D		Japanese
~XX70 16	7E 30 30 37 30 20 31 36 0D		Korean
~XX70 17	7E 30 30 37 30 20 31 37 0D		Russian
~XX70 18	7E 30 30 37 30 20 31 38 0D		Hungarian
~XX70 19	7E 30 30 37 30 20 31 39 0D		Czechoslovak
~XX70 20	7E 30 30 37 30 20 32 30 0D		Arabic
~XX70 22	7E 30 30 37 30 20 32 32 0D		Turkish
~XX70 23	7E 30 30 37 30 20 32 33 0D		Farsi
~XX70 27	7E 30 30 37 30 20 32 37 0D		Romanian
~XX71 1	7E 30 30 37 31 20 31 0D	Projection	Front-Desktop
~XX71 2	7E 30 30 37 31 20 32 0D		Rear-Desktop
~XX71 3	7E 30 30 37 31 20 33 0D		Front-Ceiling
~XX71 4	7E 30 30 37 31 20 34 0D		Rear-Ceiling
~XX72 1	7E 30 30 37 32 20 31 0D	Menu Location	Top Left
~XX72 2	7E 30 30 37 32 20 32 0D		Top Right
~XX72 3	7E 30 30 37 32 20 33 0D		Centre
~XX72 4	7E 30 30 37 32 20 34 0D		Bottom Left
~XX72 5	7E 30 30 37 32 20 35 0D		Bottom Right
(WXGA/ Model)			
~XX90 1	7E 30 30 39 30 20 31 0D	Screen Type	16:10
~XX90 0	7E 30 30 39 30 20 30 0D		16:9
~XX77 n	7E 30 30 37 37 20 aabbcc 0D	Security	Security Timer Month/Day/Hour n = mm/dd/hh mm= 00 (aa=30 30) ~ 12 (aa=31 32) dd = 00 (bb=30 30) ~ 30 (bb=33 30) hh= 00 (cc=30 30) ~ 24 (cc=32 34)
~XX78 1	7E 30 30 37 38 20 31 0D	Security Settings	On
~XX78 0 ~nnnn	7E 30 30 37 38 20 30 20 a 0D		Off(0/2 for backward compatible) ~nnnn = ~0000 (a=7E 30 30 30 30) ~9999 (a=7E 39 39 39 39)
~XX79 n	7E 30 30 37 39 20 a 0D	Projector ID	n = 00 (a=30 30) ~ 99 (a=39 39)
~XX80 1	7E 30 30 38 30 20 31 0D	Mute	On
~XX80 0	7E 30 30 38 30 20 30 0D		Off (0/2 for backward compatible)
~XX310 0	7E 30 30 33 31 30 20 30 0D	Internal Speaker	Off
~XX310 1	7E 30 30 33 31 30 20 31 0D		On
~XX81 n	7E 30 30 38 31 20 a 0D	Volume(Audio)	n = 0 (a=30) ~ 10 (a=31 30)
~XX89 0	7E 30 30 38 39 20 30 0D	Audio Input	Default
~XX89 1	7E 30 30 38 39 20 31 0D		Audio1
~XX89 3	7E 30 30 38 39 20 33 0D		Audio2
~XX82 1	7E 30 30 38 32 20 31 0D	Logo	Optoma
~XX82 2	7E 30 30 38 32 20 32 0D		User
~XX82 3	7E 30 30 38 32 20 33 0D		Neutral
~XX83 1	7E 30 30 38 33 20 31 0D	Logo Capture	
~XX88 0	7E 30 30 38 38 20 30 0D	Closed Captioning	Off
~XX88 1	7E 30 30 38 38 20 31 0D		cc1
~XX88 2	7E 30 30 38 38 20 32 0D		cc2
~XX87 1	7E 30 30 38 37 20 31 0D	Network Status(Read only Return :Ok, a=0/1 Disconnected/ Connected	
~XX87 3	7E 30 30 38 37 20 33 0D	IP Address(Read only) Return: "Okaaa_bbb_ccc_ddd"	
~XX454 0/2	7E 30 30 34 35 34 20 30(32) 0D	Crestron	Off
~XX454 1	7E 30 30 34 35 34 20 31 0D		On

Appendices

~XX455 0/2	7E 30 30 34 35 35 20 30(32) 0D	Extron	Off
~XX455 1	7E 30 30 34 35 35 20 31 0D		On
~XX456 0/2	7E 30 30 34 35 36 20 30(32) 0D	PJLink	Off
~XX456 1	7E 30 30 34 35 36 20 31 0D		On
~XX457 0/2	7E 30 30 34 35 37 20 30(32) 0D	AMX Device Discovery	Off
~XX457 1	7E 30 30 34 35 37 20 31 0D		On
~XX458 0/2	7E 30 30 34 35 38 20 30(32) 0D	Telnet	Off
~XX458 1	7E 30 30 34 35 38 20 31 0D		On
~XX39 1	7E 30 30 33 39 20 31 0D	Input Source	HDMI1
~XX39 7	7E 30 30 33 39 20 37 0D		HDMI2
~XX39 5	7E 30 30 33 39 20 35 0D		VGA1
~XX39 6	7E 30 30 33 39 20 36 0D		VGA2
~XX39 10	7E 30 30 33 39 20 31 30 0D		Video
~XX100 1	7E 30 30 31 30 30 20 31 0D	Source Lock	On
~XX100 0	7E 30 30 31 30 30 20 30 0D		Off (0/2 for backward compatible)
~XX101 1	7E 30 30 31 30 31 20 31 0D	High Altitude	On
~XX101 0	7E 30 30 31 30 31 20 30 0D		Off (0/2 for backward compatible)
~XX102 1	7E 30 30 31 30 32 20 31 0D	Information Hide	On
~XX102 0	7E 30 30 31 30 32 20 30 0D		Off (0/2 for backward compatible)
~XX103 1	7E 30 30 31 30 33 20 31 0D	Keypad Lock	On
~XX103 0	7E 30 30 31 30 33 20 30 0D		Off (0/2 for backward compatible)
~XX348 0	7E 30 30 33 34 38 20 30 0D	Display Mode Lock	Off (0/2 for backward compatible)
~XX348 1	7E 30 30 33 34 38 20 31 0D		On
~XX195 0	7E 30 30 31 39 35 20 30 0D	Test Pattern	None
~XX195 1	7E 30 30 31 39 35 20 31 0D		Grid(White)
~XX195 3	7E 30 30 31 39 35 20 33 0D		Grid(Green)
~XX195 4	7E 30 30 31 39 35 20 34 0D		Grid(Magenta)
~XX195 2	7E 30 30 31 39 35 20 32 0D		White
~XX192 0	7E 30 30 31 39 32 20 30 0D	12V Trigger	Off
~XX192 1	7E 30 30 31 39 32 20 31 0D		On
~XX104 1	7E 30 30 31 30 34 20 31 0D	Background Color	Blue
~XX104 2	7E 30 30 31 30 34 20 32 0D		Black
~XX104 3	7E 30 30 31 30 34 20 33 0D		Red
~XX104 4	7E 30 30 31 30 34 20 34 0D		Green
~XX104 5	7E 30 30 31 30 34 20 35 0D		White
~XX105 1	7E 30 30 31 30 35 20 31 0D	Advanced	Direct Power On On
~XX105 0	7E 30 30 31 30 35 20 30 0D		Off (0/2 for backward compatible)
~XX113 0	7E 30 30 31 31 33 20 30 0D		Signal Power On Off
~XX113 1	7E 30 30 31 31 33 20 31 0D		On
~XX106 n	7E 30 30 31 30 36 20 a 0D		Auto Power Off n = 0 (a=30) ~ 180 (a=31 38 30) (5 minutes for each step).
~XX107 n	7E 30 30 31 30 37 20 a 0D		Sleep Timer n = 0 (a=30) ~ 990 (a=39 39 30) (30 minutes for each step).
~XX115 1	7E 30 30 31 31 35 20 31 0D		Quick Resume On
~XX115 0	7E 30 30 31 31 35 20 30 0D		Off (0/2 for backward compatible)
~XX114 1	7E 30 30 31 31 34 20 31 0D		Power Mode(Standby) Active (<=0.5W)
~XX114 0	7E 30 30 31 31 34 20 30 0D		Eco. (0/2 for backward compatible)

Appendices

~XX109 1	7E 30 30 31 30 39 20 31 0D	Lamp Reminder	On
~XX109 0	7E 30 30 31 30 39 20 30 0D		Off (0/2 for backward compatible)
~XX110 1	7E 30 30 31 31 30 20 31 0D	Brightness Mode	Bright
~XX110 2	7E 30 30 31 31 30 20 32 0D		Eco
~XX110 3	7E 30 30 31 31 30 20 33 0D		Eco+
~XX110 4	7E 30 30 31 31 30 20 34 0D		Dynamic
~XX111 1	7E 30 30 31 31 31 20 31 0D	Lamp Reset	Yes
~XX111 0	7E 30 30 31 31 31 20 30 0D		No (0/2 for backward compatible)
~XX322 0	7E 30 30 33 32 32 20 30 0D	Filter Reminder	Off
~XX322 1	7E 30 30 33 32 32 20 31 0D		300 hrs
~XX322 2	7E 30 30 33 32 32 20 32 0D		500 hrs
~XX322 3	7E 30 30 33 32 32 20 33 0D		800 hrs
~XX322 4	7E 30 30 33 32 32 20 34 0D		1000 hrs
~XX323 1	7E 30 30 33 32 33 20 31 0D	Filter Reset	Yes
~XX323 0	7E 30 30 33 32 33 20 30 0D		No (0/2 for backward compatible)
~XX112 1	7E 30 30 31 31 32 20 31 0D	Reset	Yes

SEND to emulate Remote

~XX140 10	7E 30 30 31 34 30 20 31 30 0D	Up
~XX140 11	7E 30 30 31 34 30 20 31 31 0D	Left
~XX140 12	7E 30 30 31 34 30 20 31 32 0D	Enter (for projection MENU)
~XX140 13	7E 30 30 31 34 30 20 31 33 0D	Right
~XX140 14	7E 30 30 31 34 30 20 31 34 0D	Down
~XX140 15	7E 30 30 31 34 30 20 31 35 0D	Keystone +
~XX140 16	7E 30 30 31 34 30 20 31 36 0D	Keystone -
~XX140 17	7E 30 30 31 34 30 20 31 37 0D	Volume -
~XX140 18	7E 30 30 31 34 30 20 31 38 0D	Volume +
~XX140 19	7E 30 30 31 34 30 20 31 39 0D	Brightness
~XX140 20	7E 30 30 31 34 30 20 32 30 0D	Menu
~XX140 21	7E 30 30 31 34 30 20 32 31 0D	Zoom
~XX140 28	7E 30 30 31 34 30 20 32 38 0D	Contrast
~XX140 47	7E 30 30 31 34 30 20 34 37 0D	Source

SEND from projector automatically

232 ASCII Code	HEX Code	Function	Projector Return	Description
when Standby/Cooling/Out of Range/Lamp fail/Fan Lock/Over Temperature/Lamp Hours Running Out/Cover Open			INFO n	n : 0/1/2/3/4/6/7/8/9 = Standby/Cooling/Out of Range/Lamp fail/Fan Lock/Over Temperature/Lamp Hours Running Out/Cover Open

Appendices

READ from projector					
232 ASCII Code	HEX Code	Function	Projector Return	Description	
~XX121 1	7E 30 30 31 32 31 20 31 0D	Input Source Commands	Oka	a = 0 None a = 2 VGA-1 a = 3 VGA-2 a = 5 Video a = 7 HDMI1 a = 8 HDMI2	
~XX122 1	7E 30 30 31 32 32 20 31 0D	Software Version	OKdddd	dddd: FW version	
~XX123 1	7E 30 30 31 32 33 20 31 0D	Display Mode	Oka	a = 0 None a = 1 Presentation a = 2 Bright/ a = 3 Movie a = 4 sRGB a = 5 User a = 7 Blackboard a = 9 3D a = 12 DICOM SIM.	
~XX124 1	7E 30 30 31 32 34 20 31 0D	Power State	OKn	n : 0/1 = Off/On	
~XX125 1	7E 30 30 31 32 35 20 31 0D	Brightness	OKn		
~XX126 1	7E 30 30 31 32 37 20 31 0D	Contrast	OKn		
~XX127 1	7E 30 30 31 32 37 20 31 0D	Format	OKn	n: 1/2/3/5/6/7 =4:3/16:9/16:10/LBx/ Native/Auto	
*16:9 or 16:10 depend on Screen Type setting					
~XX128 1	7E 30 30 31 32 38 20 31 0D	Color Temperature	Oka	a=0 Standard a=1 Cool a=2 Cold	
~XX129 1	7E 30 30 31 32 39 20 31 0D	Projection Mode	OKn	n : 0/1/2/3 = Front-Desktop/ Rear- Desktop/ Front-Ceiling/ Rear-Ceiling	
~XX150 1	7E 30 30 31 35 30 20 31 1D	Information	Okabbbbcccd dddee	a = Power Status a=0 Power Off a=1 Power On b = Lamp Hour (LED Hours) bbbb Lamp Hour (LED Hours) c = Input Source cc=00 None cc=02 VGA1 cc=03 VGA2 cc=05 Video cc=07 HDMI1 cc=08 HDMI2 d = Firmware Version dddd Firmware Version e = Display mode ee=00 None ee=01 Presentation ee=02 Bright ee=03 Movie ee=04 sRGB ee=05 User ee=07 Blackboard ee=09 3D ee=12 DICOM SIM.	
~XX151 1	7E 30 30 31 35 31 20 31 0D	Model name	OKn	n:1/2/3=XGA/WGA/1080p	
~XX108 1	7E 30 30 31 30 38 20 31 0D	Lamp Hours	OKbbbb	bbbb: LampHour	
~XX108 2	7E 30 30 31 30 38 20 32 0D	Cumulative Lamp Hours	OKbbbbbb	bbbbbb: (5 digits) Total Lamp Hours	
~XX87 1	7E 30 30 38 37 20 31 0D	Network Status	Okn	n=0/1 Disconnected/Connected	

Appendices

-XX351 0	7E 30 30 33 35 31 20 30 0D	Fan1 speed(blower)	Oka	a=0000~9999
-XX352 1	7E 30 30 33 35 32 20 31 0D	System temperature	Oka	a=000~999
-XX353 1	7E 30 30 33 35 33 20 31 0D	Serial number	Okaaaaaaaaaa aaaaaaa	a=serial number string
-XX354 1	7E 30 30 33 35 34 20 31 0D	Closed Captioning	Oka	a: 0/1/2 = off/cc1/cc2
-XX355 1	7E 30 30 33 35 35 20 31 0D	AV Mute	Oka	a : 0/1 = Off/On
-XX356 1	7E 30 30 33 35 36 20 31 0D	Mute	Oka	a : 0/1 = Off/On
-XX357 1	7E 30 30 33 35 37 20 31 0D	LAN FW version	Okeeeee	eeeeee = Software Version
-XX358 1	7E 30 30 33 35 38 20 31 0D	Current Lamp Watt	Okaaaaa	aaaa=0000~9999

Ceiling Mount Installation

If you wish to use a third party ceiling mount kit, please ensure the screws used to attach a mount to the projector meet the following specifications::

- ▶ Screw type: M4*3
- ▶ Maximum screw length: 11mm
- ▶ Minimum screw length: 8mm



- ❖ Please note that damage resulting from incorrect installation will void the warranty.



⚠ Warning:

1. If you buy a ceiling mount from another company, please be sure to use the correct screw size. Screw size will vary depending on the thickness of the mounting plate.
2. Be sure to keep at least 10 cm gap between the ceiling and the bottom of the projector.
3. Avoid installing the projector near a heat source.

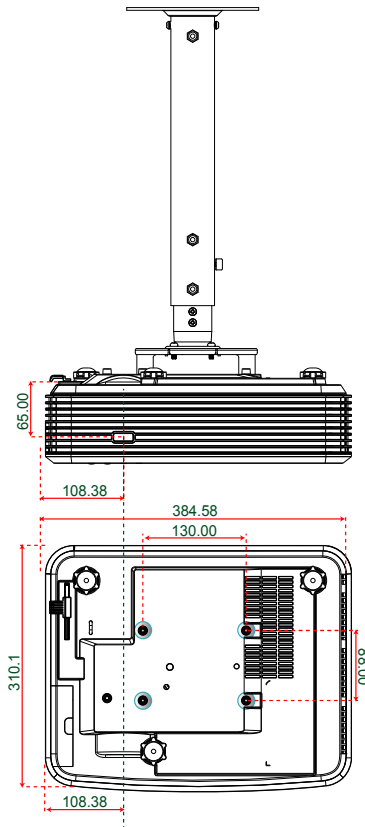



Unit: mm

Optoma Global Offices

For service or support please contact your local office.



USA

3178 Laurelview Ct.
Fremont, CA 94538, USA
www.optomausa.com

 888-289-6786
 510-897-8601
 services@optoma.com



Canada

3178 Laurelview Ct.
Fremont, CA 94538, USA
www.optomausa.com

 888-289-6786
 510-897-8601
 services@optoma.com

Latin America

3178 Laurelview Ct.
Fremont, CA 94538, USA
www.optomausa.com

 888-289-6786
 510-897-8601
 services@optoma.com



Europe

42 Caxton Way, The Watford Business Park
Watford, Hertfordshire,
WD18 8QZ, UK
www.optoma.eu
Service Tel : +44 (0)1923 691865

 +44 (0) 1923 691 800
 +44 (0) 1923 691 888
 service@tsc-europe.com



Benelux BV

Randstad 22-123
1316 BW Almere
The Netherlands
www.optoma.nl

 +31 (0) 36 820 0252
 +31 (0) 36 548 9052



France

Bâtiment E
81-83 avenue Edouard Vaillant
92100 Boulogne Billancourt, France

 +33 1 41 46 12 20
 +33 1 41 46 94 35
 savoptoma@optoma.fr

Spain



C/ José Hierro, 36 Of. 1C
28522 Rivas VaciaMadrid,
Spain

 +34 91 499 06 06
 +34 91 670 08 32

Appendices



Deutschland

Wiesenstrasse 21 W
D40549 Düsseldorf,
Germany

 +49 (0) 211 506 6670
 +49 (0) 211 506 66799
 info@optoma.de

Scandinavia



Lerpeveien 25
3040 Drammen
Norway

 +47 32 98 89 90
 +47 32 98 89 99
 info@optoma.no

PO.BOX 9515
3038 Drammen
Norway

Korea

WOOMI TECH.CO.,LTD.
4F,Minu Bldg.33-14, Kangnam-Ku,
seoul,135-815, KOREA

 +82+2+34430004
 +82+2+34430005



Japan

東京都足立区綾瀬3-25-18
株式会社オーエス
コンタクトセンター:0120-380-495

 info@os-worldwide.com
www.os-worldwide.com



Taiwan

12F, No.213, Sec. 3, Beixin Rd.,
Xindian Dist., New Taipei City 231,
Taiwan, R.O.C.
www.optoma.com.tw

 +886-2-8911-8600
 +886-2-8911-6550
 services@optoma.com.tw
asia.optoma.com



Hong Kong

Unit A, 27/F Dragon Centre,
79 Wing Hong Street,
Cheung Sha Wan,
Kowloon, Hong Kong

 +852-2396-8968
 +852-2370-1222
www.optoma.com.hk

China

5F, No. 1205, Kaixuan Rd.,
Changning District
Shanghai, 200052, China

 +86-21-62947376
 +86-21-62947375
www.optoma.com.cn

Regulation & Safety Notices

This appendix lists the general notices of your projector.

FCC Notice

This device has been tested and found to comply with the limits for a Class B digital device pursuant to Part 15 of the FCC rules. These limits are designed to provide reasonable protection against harmful interference in a residential installation. This device generates, uses and can radiate radio frequency energy and, if not installed and used in accordance with the instructions, may cause harmful interference to radio communications.

However, there is no guarantee that interference will not occur in a particular installation. If this device does cause harmful interference to radio or television reception, which can be determined by turning the device off and on, the user is encouraged to try to correct the interference by one or more of the following measures:

- ❖ Reorient or relocate the receiving antenna.
- ❖ Increase the separation between the device and receiver.
- ❖ Connect the device into an outlet on a circuit different from that to which the receiver is connected.
- ❖ Consult the dealer or an experienced radio/television technician for help.

Notice: Shielded cables

All connections to other computing devices must be made using shielded cables to maintain compliance with FCC regulations.

Caution

Changes or modifications not expressly approved by the manufacturer could void the user's authority, which is granted by the Federal Communications Commission, to operate this projector.

Operation Conditions

This device complies with Part 15 of the FCC Rules. Operation is subject to the following two conditions:

1. This device may not cause harmful interference and
2. This device must accept any interference received, including interference that may cause undesired operation.

Notice: Canadian users

This Class B digital apparatus complies with Canadian ICES-003.

Remarque à l'intention des utilisateurs canadiens

Cet appareil numérique de la classe B est conforme à la norme NMB-003 du Canada.

Declaration of Conformity for EU countries

- EMC Directive 2004/108/EC (including amendments)
- Low Voltage Directive 2006/95/EC
- R & TTE Directive 1999/5/EC (if product has RF function)



Disposal instructions

Do not throw this electronic device into the trash when discarding. To minimize pollution and ensure utmost protection of the global environment, please recycle it.

