

KRAMER



USER MANUAL

MODEL:

VS-211H2

Automatic HDMI Standby Switcher



VS-211H2 Quick Start Guide

This guide helps you install and use your **VS-211H2** for the first time. For more detailed information, go to <http://www.kramerav.com/manual/VS-211H2> to download the latest manual or scan the QR code on the left.

Step 1: Check what's in the box

- ✓ VS-211H2 Automatic HDMI Standby Switcher
- ✓ 4 Rubber feet
- ✓ 1 Bracket kit
- ✓ 1 Power supply (5V DC)
- ✓ 1 Quick start guide

Step 2: Install the VS-211H2

To mount the **VS-211H2** in a rack, use an **RK-3T** rack adapter. Alternatively, attach the rubber feet to the underside of the machine and place it on a table. You can use the **TOOL** bracket installation kit (supplied) to mount the **VS-211H2** on a desktop, wall or similar area. Fasten a bracket on each side of the **TOOL** using the two M3x8 screws (supplied). Use the flat-head screws (supplied) to fix the **TOOL** to the mounting surface or enable it to slide in place.

Step 3: Connect inputs and outputs

Always switch OFF the power on each device before connecting it to your **VS-211H2**. For best results, we recommend that you always use Kramer high-performance cables to connect AV equipment to the **VS-211H2**.

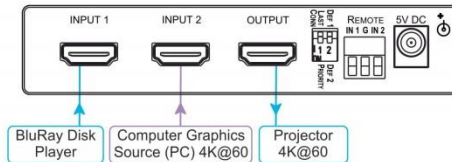

Step 4: Connect the power

Connect the 5V DC power adapter to the **VS-211H2** and plug the adapter into the mains electricity.



Step 5: Set the DIP-switches and the connect contact closure switches

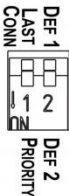

LAST CONN/PRIORITY DIP-Switch 1	Set DIP 1 up (OFF) to select the Last Connected input Set DIP 1 down (ON) to select the Priority input determined by DIP-switch 2
DEF 1/DEF 2 DIP-switch 2	Set DIP 2 up (OFF) to make input 1 the default input Set DIP 2 down (ON) to make input 2 the default input

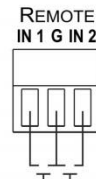

Connect external momentary switches for manual selection.

Contents

1	Introduction	1
2	Getting Started	2
2.1	Achieving the Best Performance	2
2.2	Safety Instructions	2
2.3	Recycling Kramer Products	3
3	Overview	4
3.1	Defining the VS-211H2 Automatic HDMI Standby Switcher	5
4	Connecting the VS-211H2	6
4.1	Connecting the REMOTE Terminal Block Connector	7
4.2	Setting the VS-211H2 DIP-Switches and Operation	7
5	Technical Specifications	9

Figures

Figure 1: VS-211H2 Automatic HDMI Standby Switcher	5
Figure 2: Connecting the VS-211H2 Automatic HDMI Standby Switcher	6
Figure 3: REMOTE Terminal Block Connector	7

1 Introduction

Welcome to Kramer Electronics! Since 1981, Kramer Electronics has been providing a world of unique, creative, and affordable solutions to the vast range of problems that confront video, audio, presentation, and broadcasting professionals on a daily basis. In recent years, we have redesigned and upgraded most of our line, making the best even better!

Our 1,000-plus different models now appear in 14 groups that are clearly defined by function: GROUP 1: Distribution Amplifiers; GROUP 2: Switchers and Routers; GROUP 3: Control Systems; GROUP 4: Format/Standards Converters; GROUP 5: Range Extenders and Repeaters; GROUP 6: Specialty AV Products; GROUP 7: Scan Converters and Scalers; GROUP 8: Cables and Connectors; GROUP 9: Room Connectivity; GROUP 10: Accessories and Rack Adapters; GROUP 11: Sierra Video Products; GROUP 12: Digital Signage; GROUP 13: Audio; and GROUP 14: Collaboration.

Congratulations on purchasing your Kramer **VS-211H2** Automatic HDMI Standby Switcher. This product, which incorporates HDMI™ technology, is ideal for:

- Presentation systems in conference rooms, boardrooms, auditoriums, hotels and churches, production studios, rental and staging

2 Getting Started

We recommend that you:

- Unpack the equipment carefully and save the original box and packaging materials for possible future shipment
- Review the contents of this user manual



Go to www.kramerav.com/downloads/VS-211H2 to check for up-to-date user manuals, application programs, and to check if firmware upgrades are available (where appropriate).

2.1 Achieving the Best Performance

To achieve the best performance:

- Use only good quality connection cables (we recommend Kramer high-performance, high-resolution cables) to avoid interference, deterioration in signal quality due to poor matching, and elevated noise levels (often associated with low quality cables)
- Do not secure the cables in tight bundles or roll the slack into tight coils
- Avoid interference from neighbouring electrical appliances that may adversely influence signal quality
- Position your **VS-211H2** away from moisture, excessive sunlight and dust



This equipment is to be used only inside a building. It may only be connected to other equipment that is installed inside a building.

2.2 Safety Instructions



Caution: There are no operator serviceable parts inside the unit

Warning: Use only the Kramer Electronics power supply that is provided with the unit

Warning: Disconnect the power and unplug the unit from the wall before installing

2.3 Recycling Kramer Products

The Waste Electrical and Electronic Equipment (WEEE) Directive 2002/96/EC aims to reduce the amount of WEEE sent for disposal to landfill or incineration by requiring it to be collected and recycled. To comply with the WEEE Directive, Kramer Electronics has made arrangements with the European Advanced Recycling Network (EARN) and will cover any costs of treatment, recycling and recovery of waste Kramer Electronics branded equipment on arrival at the EARN facility. For details of Kramer's recycling arrangements in your particular country go to our recycling pages at <http://www.kramerelectronics.com/support/recycling/>.

3 Overview

The **VS-211H2** is a high-performance automatic switcher for HDMI video signals. Offering priority and last-connected switching options, it automatically switches according to the selected switching scheme based on active video signal detection.

The **VS-211H2** features:

- Maximum data rate of 17.82Gbps (5.94Gbps per data channel)
- Maximum resolution 4K@60 UHD (4:4:4)
- HDTV compatible
- HDCP 2.2 and HDMI 2.0 compliant
- 3D pass-through
- HDMI support for Deep Color, x.v.Color™, Lip Sync, up to 7.1 Uncompressed Audio Channels, CEC
- Advanced auto switching based on video clock detection
- Contact closure for remote manual switching that overrides auto switching
- HDMI power on the output follows the input, (that is, there is no power on the output when there is no active input)
- EDID pass thru that passes EDID signals from display to source
- DIP-switches for setting the switching mode
- Compact DigiTOOLS® enclosure where 3 units can be rack mounted side-by-side in a 1U rack space with the optional RK-3T rack adapter

3.1 Defining the VS-211H2 Automatic HDMI Standby Switcher

This section defines the **VS-211H2**.

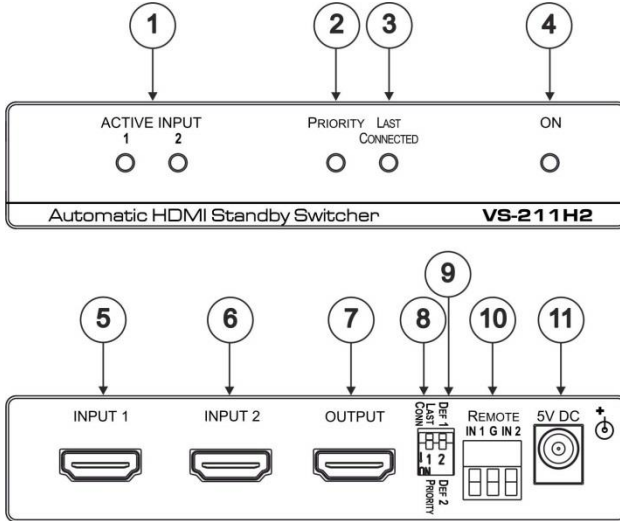

Figure 1: VS-211H2 Automatic HDMI Standby Switcher

#	Feature	Function
1	ACTIVE INPUT LEDs (1 & 2)	Each LED lights when each input is active, both LEDs flash when no input is active
2	PRIORITY LED	Lights when DIP-switch 1 is set to PRIORITY
3	LAST CONNECTED LED	Lights when DIP-switch 1 is set to LAST CONN
4	ON LED	Light when power is supplied to the unit
5	INPUT 1 Connector	Connects to HDMI source 1
6	INPUT 2 Connector	Connects to HDMI source 2
7	OUTPUT Connector	Connects to the HDMI acceptor
8	LAST CONN/PRIORITY DIP- Switch 1	Set DIP 1 up (OFF) to select the Last Connected input Set DIP 1 down (ON) to select the Priority input determined by DIP-switch 2
9	DEF 1/DEF 2 DIP-switch 2	Set DIP 2 up (OFF) to make input 1 the default input Set DIP 2 down (ON) to make input 2 the default input
10	REMOTE Terminal Block	Connects to optional contact closure switches 1 & 2 for manual switching
11	5V DC Connector	Connects to the 5V DC power supply to power the unit

4 Connecting the VS-211H2



Always switch off the power to each device before connecting it to your **VS-211H2**. After connecting your **VS-211H2**, connect its power and then switch on the power to each device.

To connect the **VS-211H2**, as illustrated in the example in [Figure 2](#), do the following:

1. Connect the INPUT 1 connector to HDMI source 1 (for example, a Blu-ray player).
2. Connect the INPUT 2 connector to HDMI source 2 (for example, a laptop computer graphics source 4K@60 UHD).
3. Connect the OUTPUT connector to an HDMI acceptor (for example, a 4K@60 UHD projector).
4. If manual switching is needed, connect contact closure (pushbutton) switches to the REMOTE terminal block see [Section 4.1](#).

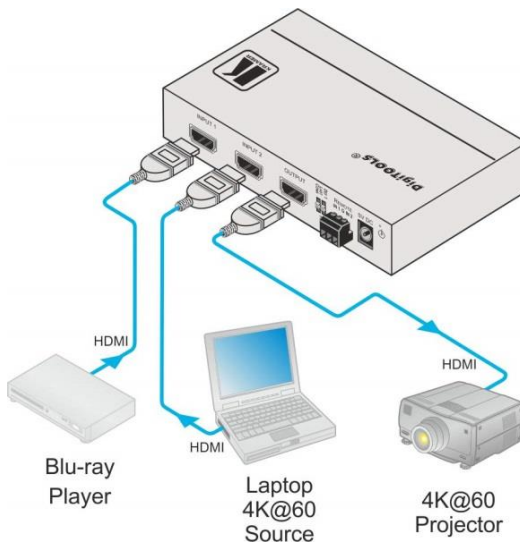

Figure 2: Connecting the VS-211H2 Automatic HDMI Standby Switcher

4.1 Connecting the REMOTE Terminal Block Connector

Regardless of the default input switch setting, you can force the switching of the active input by remote control. To do this, connect the appropriate REMOTE input terminal block connector pins to a momentary contact closure switches (pushbuttons) (see [Figure 3](#)).

- To force input source 1: momentarily connect REMOTE IN1 to PIN G (ground)
- To force I input source 2: momentarily connect REMOTE IN2 to PIN G (ground)



Do not connect both the REMOTE IN1 and the REMOTE IN2 to PIN G simultaneously

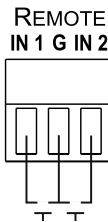

Figure 3: REMOTE Terminal Block Connector

Note: The contact closure setting remains in effect until the selected source device is disconnected or the **VS-211H2** is powered off. All automatic switching is overridden.

4.2 Setting the VS-211H2 DIP-Switches and Operation

When active input sources are connected to IN 1 and IN 2, the **VS-211H2** switches in accordance with the DIP-switch settings on the rear of the unit.

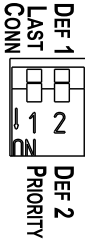

Figure 4: DIP Switches

The settings and switching behavior can be set in any of the following ways:

4.2.1 Priority Setting: DIP 1 is Set to ON (Down)

In this switching mode, if a source is present on the “priority input”, then this source is switched to the output.

DIP 2 defines the priority input:

- When set to OFF (up), INPUT 1 is the priority input
- When set to ON (down), INPUT 2 is the priority input.

Note: Reactivating or reconnecting the non-priority input has no effect on switching.

4.2.2 Last Connected Setting: DIP 1 is Set to OFF (Up)

In this switching mode, whenever a source is connected to an input which, until then, did not have a valid source connected to it, that input is switched to the output. (The reactivating or reconnecting of any source makes it the new “Last Connected” source).

DIP 2 has no effect in this switching mode

4.2.3 Manual Override: Using the REMOTE switches

Controlling via the remote contact closure pushbuttons (see [Figure 3](#)) overrides all DIP-switch settings and automatic switching until the manually selected source disconnects, becomes inactive or the **VS-211H2** is powered off.

5 Technical Specifications

INPUTS:	2 HDMI connectors
OUTPUTS:	1 HDMI connector
MAX. DATA RATE:	17.82GBPS (5.94Gbps per graphic channel)
MAX. RESOLUTION	4K@60 UHD (4:4:4)
COMPLIANCE WITH HDMI STANDARD:	HDCP and HDMI
CONTROLS:	Status/priority DIP-switches, contact closure remote control
OPERATING TEMPERATURE:	0° to +40°C (32° to 104°F)
STORAGE TEMPERATURE:	-40° to +70°C (-40° to 158°F)
HUMIDITY:	10% to 90%, RHL non-condensing
POWER CONSUMPTION:	5V DC, 400mA
DIMENSIONS:	12cm x 7.15cm x 2.44cm (4.7" x 2.8" x 1.0") W, D, H
WEIGHT:	0.156kg (0.34lbs) approx.
SHIPPING DIMENSIONS:	23.2cm x 12cm x 8.9cm (9.1" x 4.7" x 3.9") W, D, H
SHIPPING WEIGHT:	0.625kg (1.38lbs) approx.
INCLUDED ACCESSORIES:	Power supply 5.2V DC/4A desktop
OPTIONS:	RK-3T 19" rack adapter

Specifications are subject to change without notice.
For the most updated resolution list, go to our Web site at <http://www.kramerAV.com>

LIMITED WARRANTY

The warranty obligations of Kramer Electronics for this product are limited to the terms set forth below:

What is Covered

This limited warranty covers defects in materials and workmanship in this product.

What is Not Covered

This limited warranty does not cover any damage, deterioration or malfunction resulting from any alteration, modification, improper or unreasonable use or maintenance, misuse, abuse, accident, neglect, exposure to excess moisture, fire, improper packing and shipping (such claims must be presented to the carrier), lightning, power surges, or other acts of nature. This limited warranty does not cover any damage, deterioration or malfunction resulting from the installation or removal of this product from any installation, any unauthorized tampering with this product, any repairs attended by anyone unauthorized by Kramer Electronics to make such repairs, or any other cause which does not relate directly to a defect in materials and/or workmanship of this product. This limited warranty does not cover cartons, equipment enclosures, cables or accessories used in conjunction with this product.

Without limiting any other exclusion herein, Kramer Electronics does not warrant that the product covered hereby, including, without limitation, the technology and/or integrated circuit(s) included in the product, will not become obsolete or that such items are or will remain compatible with any other product or technology with which the product may be used.

How Long Does this Coverage Last

Seven years as of this printing; please check our Web site for the most current and accurate warranty information.

Who is Covered

Only the original purchaser of this product is covered under this limited warranty. This limited warranty is not transferable to subsequent purchasers or owners of this product.

What Kramer Electronics will do

Kramer Electronics will, at its sole option, provide one of the following three remedies to whatever extent it shall deem necessary to satisfy a proper claim under this limited warranty:

1. Elect to repair or facilitate the repair of any defective parts within a reasonable period of time, free of any charge for the necessary parts and labor to complete the repair and restore this product to its proper operating condition. Kramer Electronics will also pay the shipping costs necessary to return this product once the repair is complete.
2. Replace this product with a direct replacement or with a similar product deemed by Kramer Electronics to perform substantially the same function as the original product.
3. Issue a refund of the original purchase price less depreciation to be determined based on the age of the product at the time remedy is sought under this limited warranty.

What Kramer Electronics will not do Under This Limited Warranty

If this product is returned to Kramer Electronics or the authorized dealer from which it was purchased or any other party authorized to repair Kramer Electronics products, this product must be insured during shipment, with the insurance and shipping charges prepaid by you. If this product is returned uninsured, you assume all risks of loss or damage during shipment. Kramer Electronics will not be responsible for any costs related to the removal or re-installation of this product from or into any installation. Kramer Electronics will not be responsible for any costs related to any setting up this product, any adjustment of user controls or any programming required for a specific installation of this product.

How to Obtain a Remedy under this Limited Warranty

To obtain a remedy under this limited warranty, you must contact either the authorized Kramer Electronics reseller from whom you purchased this product or the Kramer Electronics office nearest you. For a list of authorized Kramer Electronics resellers and/or Kramer Electronics authorized service providers, please visit our web site at www.kramerelectronics.com or contact the Kramer Electronics office nearest you.

In order to pursue any remedy under this limited warranty, you must possess an original, dated receipt as proof of purchase from an authorized Kramer Electronics reseller. If this product is returned under this limited warranty, a return authorization number, obtained from Kramer Electronics, will be required. You may also be directed to an authorized reseller or a person authorized by Kramer Electronics to repair the product.

If it is decided that this product should be returned directly to Kramer Electronics, this product should be properly packed, preferably in the original carton, for shipping. Cartons not bearing a return authorization number will be refused.

Limitation on Liability

THE MAXIMUM LIABILITY OF KRAMER ELECTRONICS UNDER THIS LIMITED WARRANTY SHALL NOT EXCEED THE ACTUAL PURCHASE PRICE PAID FOR THE PRODUCT. TO THE MAXIMUM EXTENT PERMITTED BY LAW, KRAMER ELECTRONICS IS NOT RESPONSIBLE FOR DIRECT, SPECIAL, INCIDENTAL OR CONSEQUENTIAL DAMAGES RESULTING FROM ANY BREACH OF WARRANTY OR CONDITION, OR UNDER ANY OTHER LEGAL THEORY. Some countries, districts or states do not allow the exclusion or limitation of relief, special, incidental, consequential or indirect damages, or the limitation of liability to specified amounts, so the above limitations or exclusions may not apply to you.

Exclusive Remedy

TO THE MAXIMUM EXTENT PERMITTED BY LAW, THIS LIMITED WARRANTY AND THE REMEDIES SET FORTH ABOVE ARE EXCLUSIVE AND IN LIEU OF ALL OTHER WARRANTIES, REMEDIES AND CONDITIONS, WHETHER ORAL OR WRITTEN, EXPRESS OR IMPLIED. TO THE MAXIMUM EXTENT PERMITTED BY LAW, KRAMER ELECTRONICS SPECIFICALLY DISCLAIMS ANY AND ALL IMPLIED WARRANTIES, INCLUDING WITHOUT LIMITATION, WARRANTIES OF MERCHANTABILITY AND FITNESS FOR A PARTICULAR PURPOSE. IF KRAMER ELECTRONICS CANNOT LAWFULLY DISCLAIM OR EXCLUDE IMPLIED WARRANTIES UNDER APPLICABLE LAW, THEN ALL IMPLIED WARRANTIES COVERING THIS PRODUCT, INCLUDING WARRANTIES OF MERCHANTABILITY AND FITNESS FOR A PARTICULAR PURPOSE, SHALL APPLY TO THIS PRODUCT AS PROVIDED UNDER APPLICABLE LAW.

IF ANY PRODUCT TO WHICH THIS LIMITED WARRANTY APPLIES IS A "CONSUMER PRODUCT" UNDER THE MAGNUSON-MOSS WARRANTY ACT (15 U.S.C.A. §2301, ET SEQ.) OR OTHER APPLICABLE LAW, THE FOREGOING DISCLAIMER OF IMPLIED WARRANTIES SHALL NOT APPLY TO YOU, AND ALL IMPLIED WARRANTIES ON THIS PRODUCT, INCLUDING WARRANTIES OF MERCHANTABILITY AND FITNESS FOR THE PARTICULAR PURPOSE, SHALL APPLY AS PROVIDED UNDER APPLICABLE LAW.

Other Conditions

This limited warranty gives you specific legal rights, and you may have other rights which vary from country to country or state to state.

This limited warranty is void if (i) the label bearing the serial number of this product has been removed or defaced, (ii) the product is not distributed by Kramer Electronics or (iii) this product is not purchased from an authorized Kramer Electronics reseller. If you are unsure whether a reseller is an authorized Kramer Electronics reseller, please visit our Web site at www.kramerelectronics.com or contact a Kramer Electronics office from the list at the end of this document.

Your rights under this limited warranty are not diminished if you do not complete and return the product registration form or complete and submit the online product registration form. Kramer Electronics thanks you for purchasing a Kramer Electronics product. We hope it will give you years of satisfaction.

KRAMER



P/N: 2900-300581



Rev: 1



SAFETY WARNING

Disconnect the unit from the power supply before opening and servicing

For the latest information on our products and a list of Kramer distributors, visit our Web site to find updates to this user manual.

We welcome your questions, comments, and feedback.

www.kramerAV.com
info@kramerel.com