

USER MANUAL

MODEL:

PA-240Net
240W Power Amplifier

PA-120Net
120W Power Amplifier



Contents

Introduction	1
Getting Started	1
Overview	2
Typical Applications	3
Defining the PA-240Net and PA-120Net Power Amplifier	4
Connecting the PA-240Net	6
Connecting the Output to a Balanced/Unbalanced Stereo Audio Acceptor	7
Connecting a Balanced/Unbalanced Stereo Audio Source to the Balanced Input	8
Connecting to PA-240Net via RS-232	8
RJ-45 Pinout	8
Connecting PA-240Net via the Ethernet Port	9
Operating the PA-240Net	11
Setting the DIP-Switches	11
Adjusting the Master Volume	11
Using the Embedded Web Pages	12
Setting the Speaker Output Parameters	13
Setting the Line Level Output Parameters	15
Selecting Hi-Z Mono Settings	16
Changing Standby Settings	16
Setting Device Parameters	17
Managing Web Page Security	19
Viewing the About Page	21
Using the Web-based Dante Controller	21
Technical Specifications	22
Default Communication Parameters	23
Protocol 3000	24
Understanding Protocol 3000	25
Kramer Protocol 3000 Syntax	26
Protocol 3000 Commands	27

Introduction

Welcome to Kramer Electronics! Since 1981, Kramer Electronics has been providing a world of unique, creative, and affordable solutions to the vast range of problems that confront the video, audio, presentation, and broadcasting professional on a daily basis. In recent years, we have redesigned and upgraded most of our line, making the best even better!

Getting Started

We recommend that you:

- Unpack the equipment carefully and save the original box and packaging materials for possible future shipment.
- Review the contents of this user manual.



Go to www.kramerav.com/downloads/PA-240Net or www.kramerav.com/product/PA-120Net to check for up-to-date user manuals, application programs, and to check if firmware upgrades are available (where appropriate).

Achieving the Best Performance

- Use only good quality connection cables (we recommend Kramer high-performance, high-resolution cables) to avoid interference, deterioration in signal quality due to poor matching, and elevated noise levels (often associated with low quality cables).
- Do not secure the cables in tight bundles or roll the slack into tight coils.
- Avoid interference from neighboring electrical appliances that may adversely influence signal quality.
- Position your Kramer **PA-240Net/PA-120Net** away from moisture, excessive sunlight and dust.



This equipment is to be used only inside a building. It may only be connected to other equipment that is installed inside a building.

Safety Instructions



Caution: There are no operator serviceable parts inside the unit.

Warning: Use only the power cord that is supplied with the unit.

Warning: Do not open the unit. High voltages can cause electrical shock! Servicing by qualified personnel only.

Warning: Disconnect the power and unplug the unit from the wall before installing.

Recycling Kramer Products

The Waste Electrical and Electronic Equipment (WEEE) Directive 2002/96/EC aims to reduce the amount of WEEE sent for disposal to landfill or incineration by requiring it to be collected and recycled. To comply with the WEEE Directive, Kramer Electronics made arrangements with the European Advanced Recycling Network (EARN) and will cover any costs of treatment, recycling and recovery of waste Kramer Electronics branded equipment on arrival at the EARN facility. For details of Kramer's recycling arrangements in your country, go to our recycling pages at www.kramerav.com/support/recycling.

Overview

Congratulations on purchasing your Kramer **PA-240Net 240W Power Amplifier** and/or **PA-120Net 120W Power Amplifier**.



Although this user manual describes the **PA-240Net** it refers to both **PA-240Net** and **PA-120Net**, unless specified otherwise.

PA-240Net is a high-performance Hi-Z (70V/100V) and Lo-Z (4/8Ω), network controllable power amplifier featuring balanced & unbalanced inputs, and a line-level balanced output. This powerful amplifier is suitable for large-scale applications.

PA-240Net is housed in a desktop sized enclosure and can be setup using one of the following methods:

- Mount the unit in a rack using the recommended rack adapter (see www.kramerav.com/product/PA-120Net).
- Attach the rubber feet and place the unit on a flat surface.

PA-240Net provides exceptional quality and user-friendly operation.

PA-240Net features control via the Dante™ IP control matrix or Kramer Protocol 3000 via RS-232 or USB connections

Exceptional Quality

- For **PA-240Net**:
 - A single channel of 240W into a 70V/100V line.
 - 2 channels of 120W into 4/8Ω.
- For **PA-120Net**:
 - A single channel of 120W into a 70V/100V line.
 - 2 channels of 60W into 4/8Ω.
- Individual input mix, EQ and HPF (High-Pass Filter) per output.
- Built-in 3-band parametric EQ.

User-friendly Operation

- Status LED indicators for the selected input, output muted and clipped signal on the output.
- Over-current, short circuit or over-heat protection – The PROTECT LED lights and the device shuts down until correct operational conditions are regained.
- Dante LED indicator for Dante network availability.
- Digital audio normal operation LED.
- Auto-standby with adjustable threshold.
- Controllable via RS-232 and IP.

Typical Applications

The PA-240Net is ideal for the following typical applications:

- Medium to large meeting rooms.
- Auditoriums and lecture halls.
- Court rooms.
- Retail stores and shopping centers.
- Hotel lobbies.
- Transportation hubs.

Defining the PA-240Net and PA-120Net Power Amplifier

This section defines the PA-240Net.

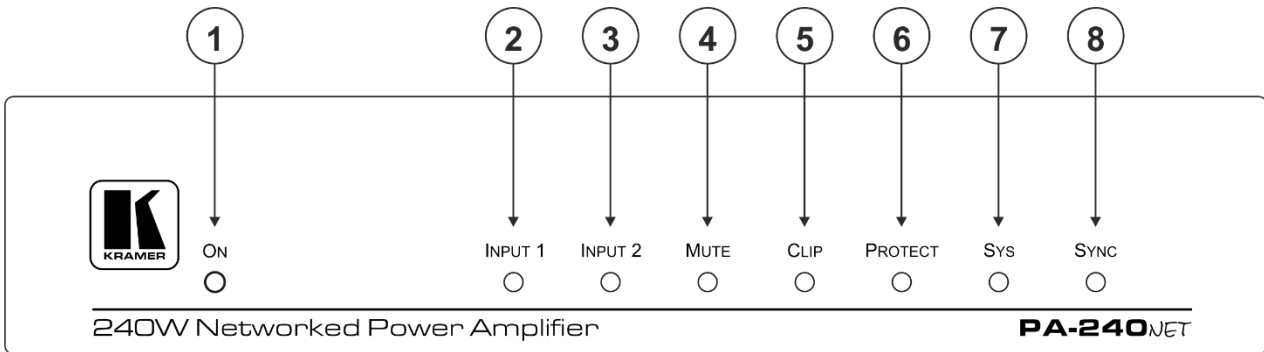
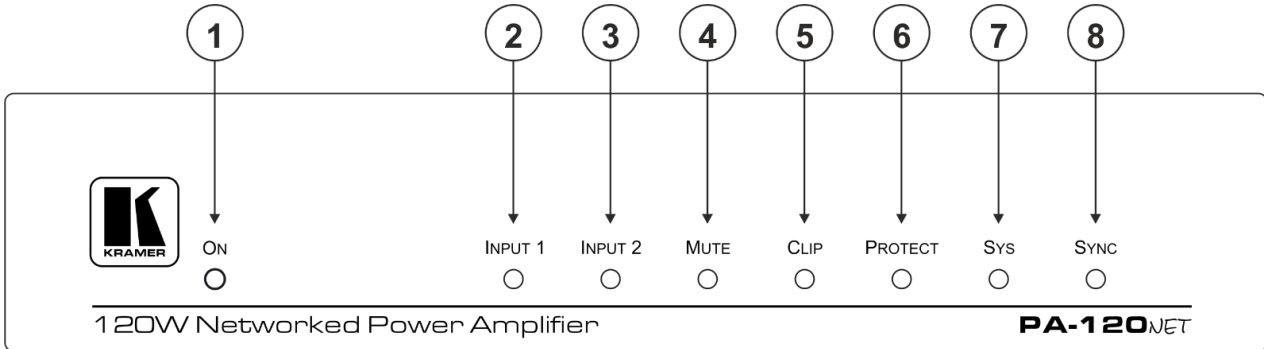

#	Feature	Function
①	ON LED	Lights green when powered on, orange when in standby.
②	INPUT 1 LED	Lights green when a signal is present on input 1.
③	INPUT 2 LED	Lights green when a signal is present on input 2.
④	MUTE	Lights red when the speaker output is muted, off when unmuted.
⑤	CLIP LED	Lights red when the signal is clipped on the output and creating distortion. (When clipping is detected, lower the volume until the LED turns off.)
⑥	PROTECT LED	Lights red in case of over-current / short / over-heating. The device powers down until operation conditions are corrected and then powers up again.
⑦	SYS LED	Lights green when Dante network is available. Lights red if an error has occurred.
⑧	SYNC LED	Lights green for digital audio normal operation. Flashes green when this unit is the Master clock. Lights red if an error has occurred.

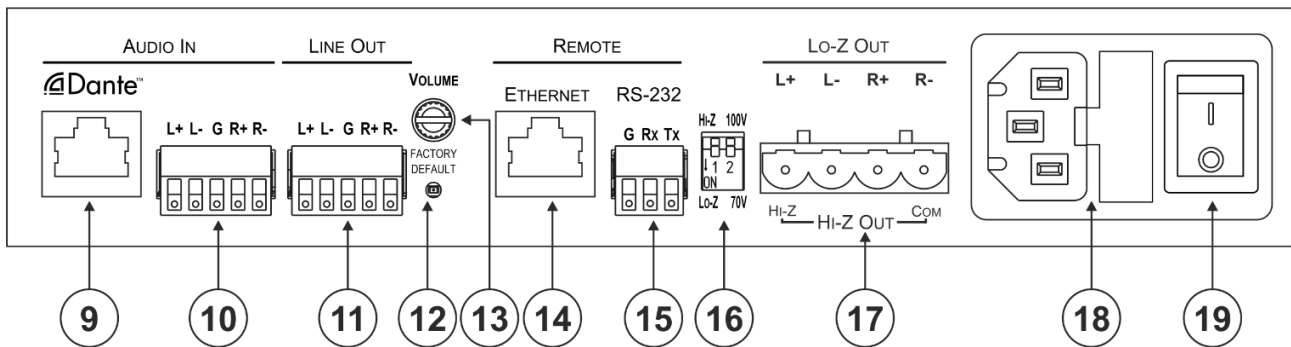

#	Feature	Function
9	Dante RJ-45 Port	Connect to the Dante™ audio source via the Network. By default, DHCP is enabled.
10	AUDIO IN Balanced/Unbalanced Stereo Audio 5-pin Terminal Block Connector	Connect to a line-level, balanced/unbalanced, stereo audio source.
11	LINE OUT Balanced Stereo Audio 5-pin Terminal Block Connector	Connect to a balanced, stereo audio acceptor (for example, amplified speakers).
12	FACTORY DEFAULT Button	Press to return to the factory default settings, including all the configurations and network settings.
13	VOLUME Attenuator	Master volume for speaker output – rotate to set the maximum amplifier volume.
14	ETHERNET RJ-45 Connector	Connect to an ETHERNET LAN to control the PA-240Net via built-in web page. By default, IP is fixed at 192.168.1.39.
15	RS-232 (G, Tx, Rx) Port	Connect to an RS-232 connector on AV equipment or a PC or other Serial Controller.
16	Hi-Z/Lo-Z and 100V/70V DIP-Switches	DIP-Switch 1: Set to Hi-Z for high impedance or Lo-Z for low impedance. DIP-Switch 2: In Hi-Z mode, select 70V or 100V operation.
17	Lo-Z and Hi-Z Speaker Output Terminal Block Connector	Lo-Z – Connect left +, left -, right +, and right - to Lo-Z (4Ω or 8Ω) speakers. Hi-Z – connect Hi-Z and COM to 70V or 100V Hi-Z speakers. In Hi-Z mode, the output is mono and can be selected via webpage – Left channel to mono, or stereo to mono summing
18	Power Connector with Fuse	AC connector, enabling power supply to the unit.
19	Mains Power Switch	Switch for turning the device on or off.

Connecting the PA-240Net



Always switch off the power to each device before connecting it to your **PA-240Net**. After connecting your **PA-240Net**, connect its power and then switch on the power to each device.

To connect the **PA-240Net** as illustrated in the example in [Figure 1](#):

1. Connect the balanced stereo audio source to the AUDIO IN 5-pin terminal block connector [\(10\)](#) (for example, a Kramer Switcher/Scaler).
2. Connect the LINE OUT balanced stereo audio 5-pin terminal block connector [\(11\)](#) to a balanced stereo acceptor (for example, an additional **PA-240Net** device).
3. Connect the Hi-Z OUT or Lo-Z OUT 4-pin terminal block connector [\(17\)](#) as follows:
 - For Hi-Z connection: connect Hi-Z and COM terminal blocks to the + and – terminals of a mono speaker (for example, the **Galil 8-C** ceiling speakers, daisy chained). The speakers either output the left side (L+, L-) of the audio input or the stereo input reduced to a mono signal (see [Selecting Hi-Z Mono Settings](#) on page [16](#)).
 - For Lo-Z connection: connect the L+ and L- connectors to the left-side speaker and the R+ and R- connectors to the right-side.
4. Set the Hi-Z/Lo-Z and 100V/70V DIP-Switches [\(16\)](#):
 - For Hi-Z operation: Set DIP-switch 1 to Hi-Z and then set DIP-switch 2 to 70V or 100V.
 - For Lo-Z operation: Set DIP-switch 1 to Lo-Z.
5. Connect the Dante RJ-45 connector to any available IP network.
6. If required, connect:
 - A PC via RS-232 [\(15\)](#), see [Connecting to PA-240Net via RS-232](#) on page [8](#).
 - The ETHERNET port [\(14\)](#), see [Connecting PA-240Net via the Ethernet Port](#) on page [9](#).
7. Connect the power cord (not shown in [Figure 1](#)).

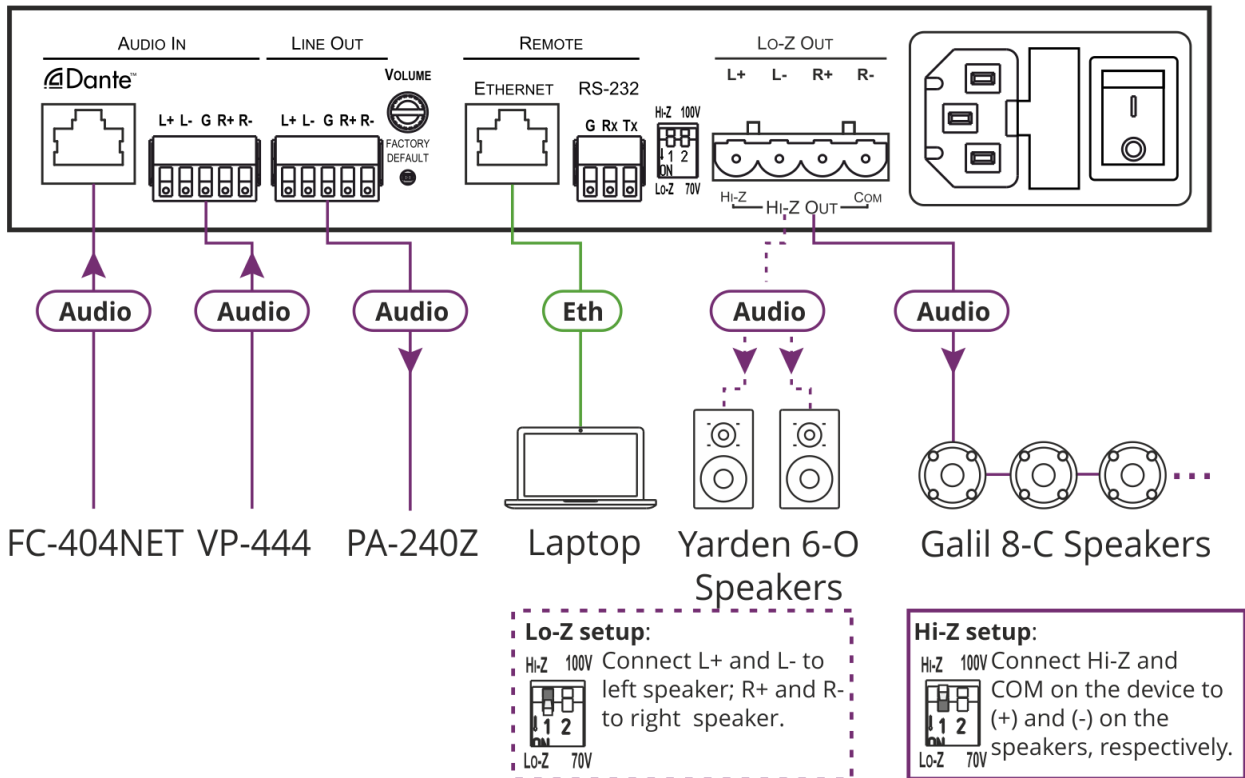

Figure 1: Connecting to the PA-240Net Rear Panel

Connecting the Output to a Balanced/Unbalanced Stereo Audio Acceptor

The following are the pinouts for connecting the output to a balanced or unbalanced stereo audio acceptor:

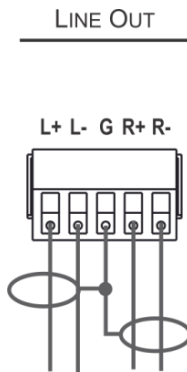

Figure 2: Connecting the output to a balanced stereo audio acceptor

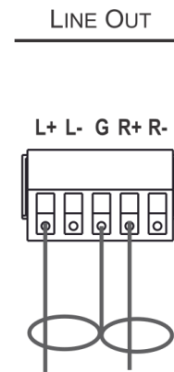

Figure 3: Connecting the output to an unbalanced stereo audio acceptor

Connecting a Balanced/Unbalanced Stereo Audio Source to the Balanced Input

The following are the pinouts for connecting a balanced or unbalanced stereo audio source to the balanced input:

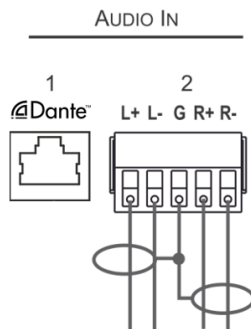

Figure 4: Connecting a balanced stereo audio source to the balanced input

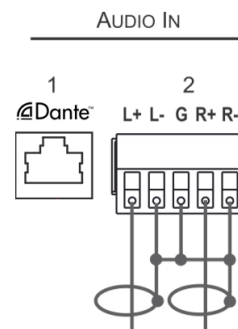

Figure 5: Connecting an unbalanced stereo audio source to the balanced input

Connecting to PA-240Net via RS-232

You can connect to the **PA-240Net** via an RS-232 connection ⁽¹⁵⁾ using, for example, a PC.

From the RS-232 9-pin D-sub serial port connect:

- Pin 2 to the TX pin on the **PA-240Net** RS-232 terminal block.
- Pin 3 to the RX pin on the **PA-240Net** RS-232 terminal block.
- Pin 5 to the G pin on the **PA-240Net** RS-232 terminal block.

RJ-45 Pinout

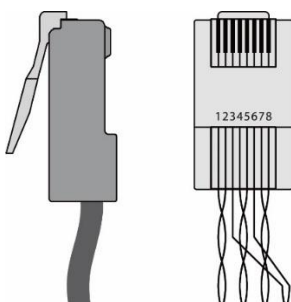

PIN EIA /TIA 568B	
PIN	Wire Color
1	Orange / White
2	Orange
3	Green / White
4	Blue
5	Blue / White
6	Green
7	Brown / White
8	Brown

Connecting PA-240Net via the Ethernet Port

You can connect to the PA-240Net via Ethernet using either of the following methods:

- Directly to the PC using a crossover cable (see [Connecting the Ethernet Port Directly to a PC](#) on page 9).
- Via a network hub, switch, or router, using a straight-through cable (see [Connecting the Ethernet Port via a Network Hub or Switch](#) on page 11).



If you want to connect via a router and your IT system is based on IPv6, speak to your IT department for specific installation instructions.

Connecting the Ethernet Port Directly to a PC

You can connect the Ethernet port of the PA-240Net directly to the Ethernet port on your PC using a crossover cable with RJ-45 connectors.



This type of connection is recommended for identifying the PA-240Net with the factory configured default IP address

After connecting the PA-240Net to the Ethernet port, configure your PC as follows:

1. Click **Start > Control Panel > Network and Sharing Center**.
2. Click **Change Adapter Settings**.
3. Highlight the network adapter you want to use to connect to the device and click **Change settings of this connection**.

The Local Area Connection Properties window for the selected network adapter appears as shown in [Figure 6](#).

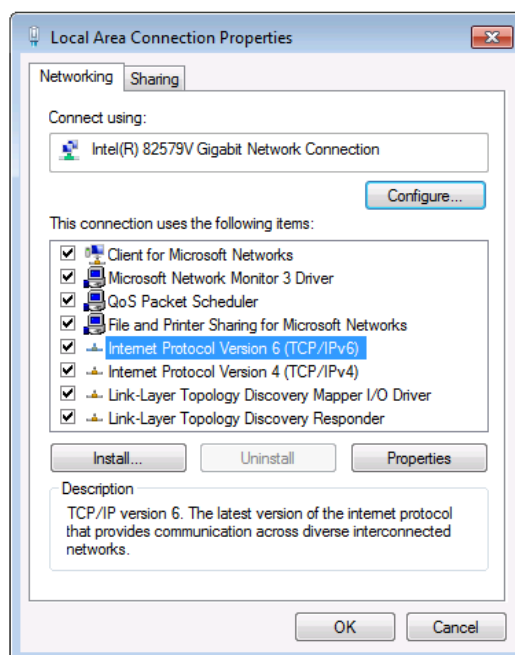

Figure 6: Local Area Connection Properties Window

4. Highlight either **Internet Protocol Version 6 (TCP/IPv6)** or **Internet Protocol Version 4 (TCP/IPv4)** depending on the requirements of your IT system.
5. Click **Properties**.
The Internet Protocol Properties window relevant to your IT system appears as shown in [Figure 7](#) or [Figure 8](#).

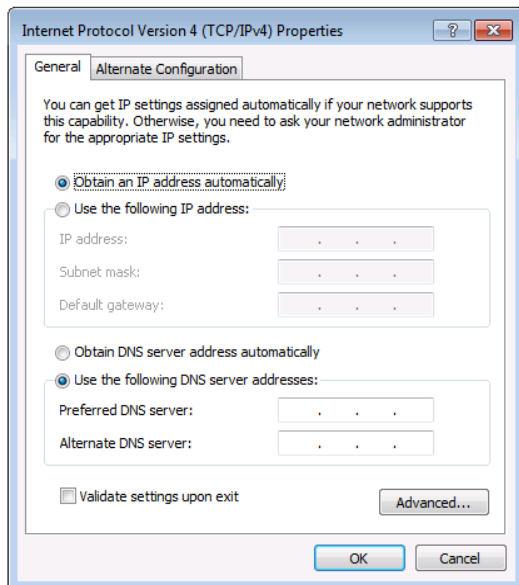

Figure 7: Internet Protocol Version 4 Properties Window

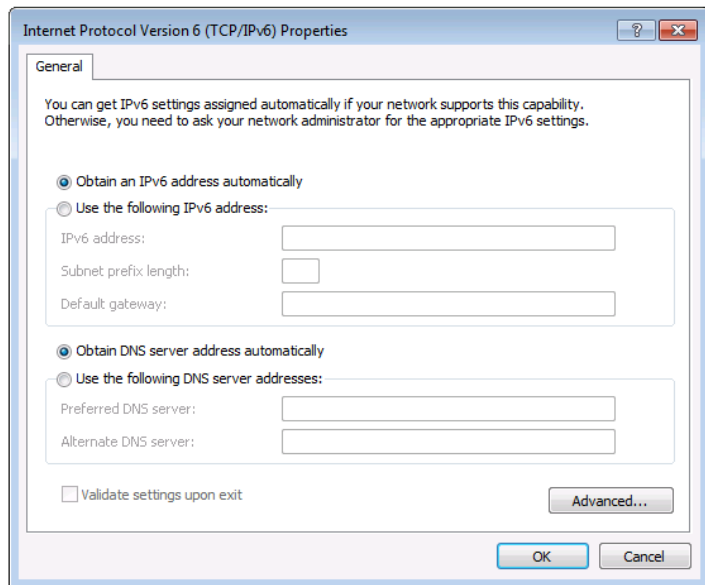

Figure 8: Internet Protocol Version 6 Properties Window

6. Select **Use the following IP Address** for static IP addressing and fill in the details as shown in [Figure 9](#).
For TCP/IPv4 you can use any IP address in the range 192.168.1.1 to 192.168.1.255 (excluding 192.168.1.39) that is provided by your IT department.

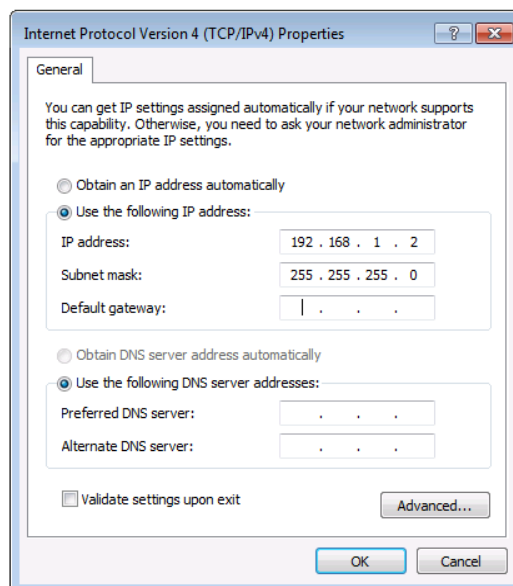

Figure 9: Internet Protocol Properties Window

7. Click **OK**.
8. Click **Close**.

Connecting the Ethernet Port via a Network Hub or Switch

You can connect the Ethernet port of the PA-240Net to the Ethernet port on a network hub or using a straight-through cable with RJ-45 connectors.

Control Configuration via the Ethernet Port

To control several units via Ethernet, connect the Master unit (Device 1) via the Ethernet port to the Ethernet port of your PC. Use your PC provide initial configuration of the settings (see [Connecting PA-240Net via the Ethernet Port](#) on page 9).



Operating the PA-240Net

This section describes the following operations:

- [Setting the DIP-Switches](#) on page 11.
- [Adjusting the Master Volume](#) on page 11.

Setting the DIP-Switches

By default, the DIP-switches (16) are set to Hi-Z and 100V.

DIP-Switch #	Setting
1	Set to Hi-Z (up) for high impedance configurations.  Use when connecting mono speakers in daisy-chain.
	Set to Lo-Z (down) for low impedance configurations.  Use when connecting to a single pair of speakers, one to the left and one to the right.
2	When DIP-switch 1 is set to Hi-Z (up), set DIP-switch 2 either to 70V (down) or 100V (up), according to your requirements.

Adjusting the Master Volume

Use the VOLUME attenuator (13) on the rear panel to set the maximum level for the speaker output. Adjust the master volume (speaker output) via the web pages, see [Setting the Master Volume and Balance](#) on page 14.

Using the Embedded Web Pages

Control the PA-240Net via the web pages which are accessed using a Web browser and an Ethernet connection.

Before attempting to connect:

- Perform the procedures described in [Connecting PA-240Net via the Ethernet Port](#) on page 9.
- Ensure that your browser is supported.

The following operating systems and Web browsers are supported:

OS	Browser
Windows (7 and higher)	IE
	FireFox
	Chrome
Mac/iOS	Safari
Android	Chrome

The PA-240Net web pages enable performing the following:

- [Setting the Speaker Output Parameters](#) on page 13.
- [Setting the Line Level Output Parameters](#) on page 15.
- [Selecting Hi-Z Mono Settings](#) on page 16.
- [Changing Standby Settings](#) on page 16.
- [Setting Device Parameters](#) on page 17.
- [Managing Web Page Security](#) on page 19.
- [Viewing the About Page](#) on page 21.
- [Using the Web-based Dante Controller](#) on page 21.

To browse the PA-240Net web pages:

1. Open your Internet browser.
2. Type the IP address of the device in the address bar of your browser. For example, the default IP address:



The Authentication window appears (if security is enabled).

3. Enter the User Name (Admin, by default) and Password (Admin, by default) and click **OK**.

The Speaker Output page appears:

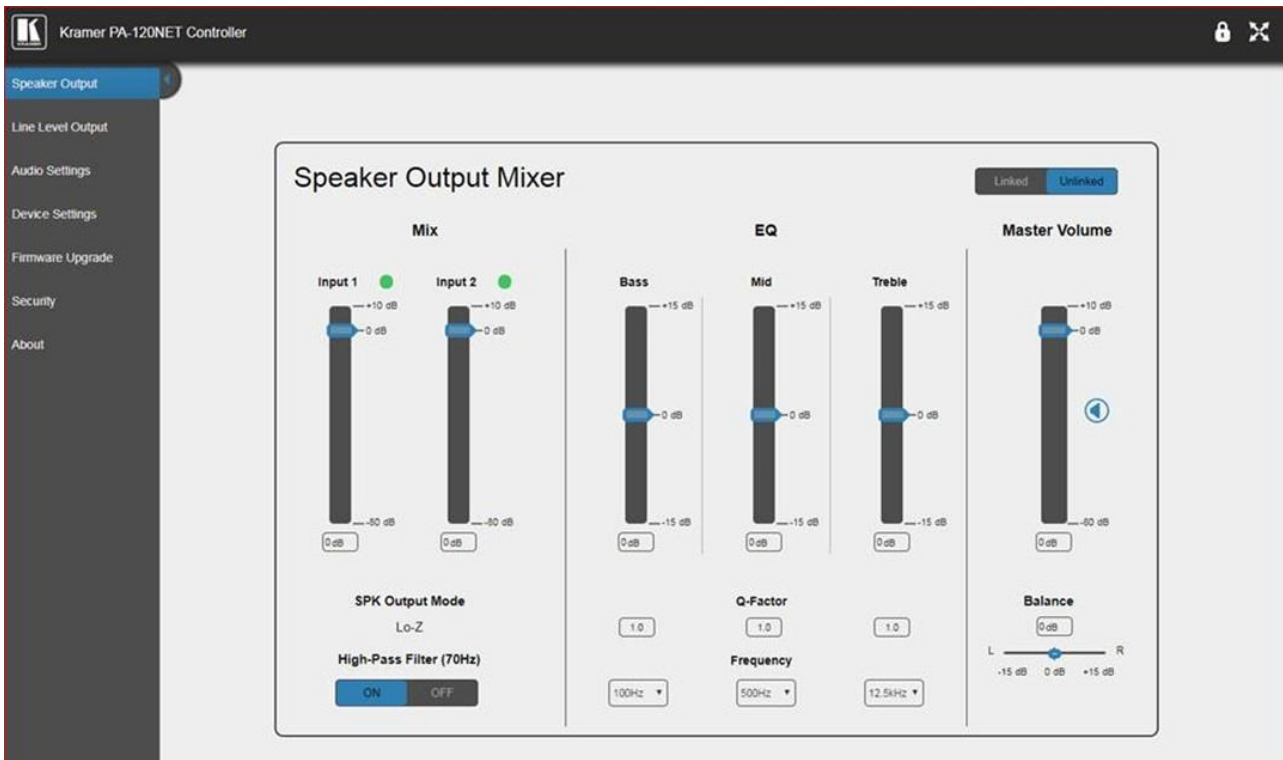

Figure 10: Speaker Output Page

4. Click the desired web page using the navigation list on the left or click the arrow at the top to hide the navigation list.

Setting the Speaker Output Parameters

Use the Speaker Output page to set the speaker input signals mixing and the output parameters.



PA-240Net can automatically set the line level output parameters according to the speaker output parameters (see [Setting the Line Level Output Parameters](#) on page 15).

The Speaker Output Mixer enables performing the following operations:

- [Mixing the Input Signal Levels](#) on page 14.
- [Setting Equalization Levels](#) on page 14.
- [Setting the Master Volume and Balance](#) on page 14.

Mixing the Input Signal Levels



The indication buttons next to Input 1 and Input 2 appear green when there is an active signal on that input.

To set the Mixing Level:

1. In the Navigation pane, click **Speaker Output**.
The Speaker Output page appears (see [Figure 10](#)).
2. In the Mix column, use the sliders to set the mixing level for each input or enter their value below the sliders.
3. Set the High-Pass Filter **ON** or **OFF** to cut-off frequencies lower than 70Hz.



To save energy, enable the High-Pass Filter when outputting soft background music or speech sources.

Setting Equalization Levels

We recommend that you first set the frequencies, then the Q and finally the Bass Mid and Treble ranges.

To set EQ levels:

1. In the navigation pane click **Speaker Output**. The Speaker Output page appears.
2. In the EQ column set the following:
 - Frequency: Bass [60Hz, 80Hz, 100Hz or 200Hz] Mid [500Hz, 1kHz, 1.5kHz or 2.5kHz] and Treble [10kHz, 12.5kHz, 15kHz or 17.5kHz] frequency.
 - Q-Factor: Bass, Mid and Treble [0.1 to 16].
The lower the Q value, the wider the bandwidth.
 - Equalization: Bass, Mid and Treble via the sliders or enter their value [dB] below the sliders.

Setting the Master Volume and Balance

The maximum master volume level of the speaker output is set via the VOLUME attenuator ⁽¹³⁾ on the rear panel, see [Adjusting the Master Volume](#) on page [11](#).

In the Master Volume column:

- Use the slider to set the speaker audio level or enter the value [dB] below the slider.
- Click  to mute/unmute the output volume.
- Set the left right balance on the speaker output.

Setting the Line Level Output Parameters

PA-240Net can automatically set the line level output parameters according to the speaker output parameters (see [Setting the Speaker Output Parameters](#) on page 13), or they can be set manually via the Line Level Output page.

To set the line level output parameters independently (unlinked to speaker output parameters):

1. In the Navigation pane, click **Speaker Output**. The Speaker Output page appears.
2. Click **Unlinked**.
3. In the Navigation pane, click **Line Level Output**. The Line Level Output page appears.

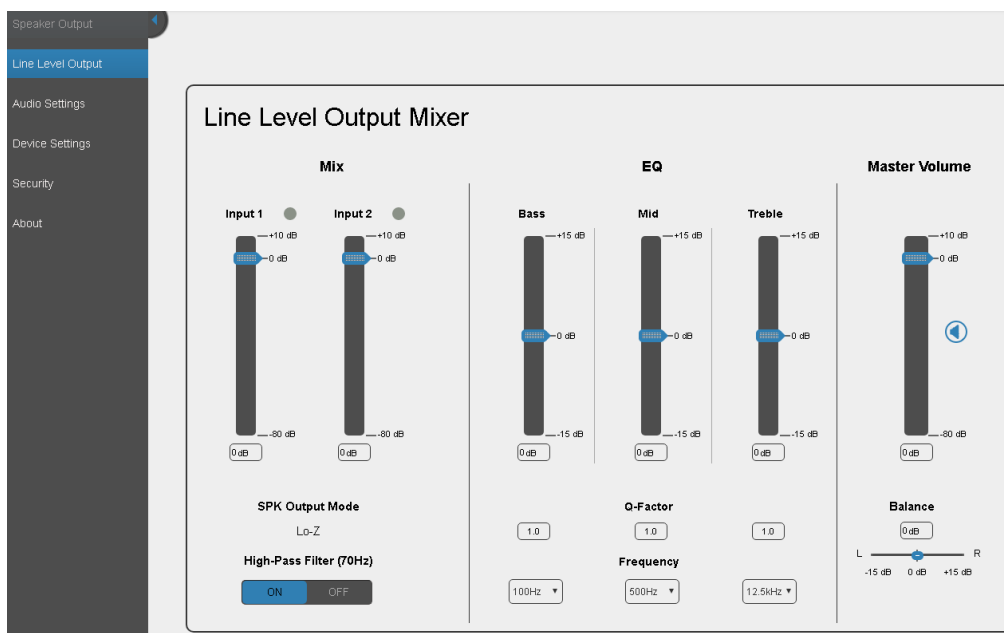

Figure 11: Line Level Output Page

4. Set the line level parameters (see [Setting the Speaker Output Parameters](#) on page 13).

Selecting Hi-Z Mono Settings

To Select Hi-Z Mono Settings:

1. In the Navigation pane, click **Audio Settings**. The Audio Settings page appears.

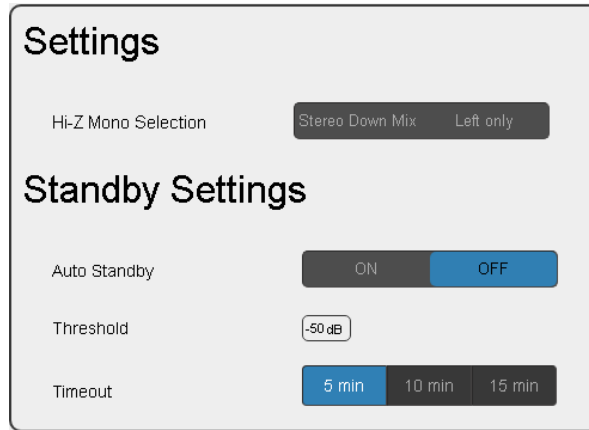

Figure 12: Audio Settings Page

2. Set the Hi-Z reduction to mono to one of the following:
 - Select **Left only** to use left audio in connectors.
 - Select **Stereo Down Mix** to reduce the stereo input to mono.

Changing Standby Settings

To change standby settings:

1. In the Navigation pane, click **Audio Settings**.
The Audio Settings page appears (see [Figure 12](#)).
2. Define the Standby Settings:

- Set auto standby to **ON** or **OFF**.
- Type the audio threshold to initiate auto standby.



The "threshold" sets what is considered a valid input signal by the amplifier, and what is considered noise.

This will also influence the front panel LEDs. If the input signal becomes lower than the threshold, the LEDs will not illuminate.

- Set the standby timeout to **5**, **10** or **15** minutes.

Setting Device Parameters

The Device Settings Web page shows the device details, such as name, MAC address and firmware version. It also allows the following functions:

- Changing the name of the unit by typing the name in the Unit name text box.
- [Changing the Ethernet Controller/Ethernet Dante Settings](#) on page 17.
- [Saving and Loading Settings](#) on page 18.
- [Performing a Factory Reset](#) on page 18.

Changing the Ethernet Controller/Ethernet Dante Settings

To change the Ethernet settings, if required:

1. In the Navigation pane, click **Device Settings**. The Device Settings page appears:

The screenshot shows the 'Device Settings' web page. At the top, the 'Unit name' is 'PA-120NET-' with a 'Set' button. Below this, the 'Model' is 'PA-120NET' and the 'Serial number' is not visible. The page is divided into two main sections: 'Ethernet - Controller' and 'Ethernet - Dante'.

Ethernet - Controller:

- DHCP: A toggle switch set to 'OFF'.
- IP address: 192 . 168 . 1 . 39
- Mask address: 255 . 255 . 0 . 0
- Gateway address: 192 . 168 . 0 . 1
- Mac address: 00-1d-56-00-34-9e
- UDP port: 50000
- TCP port: 5000

Ethernet - Dante:

- DHCP: A toggle switch set to 'ON'.
- IP address: 192 . 168 . 1 . 6
- Mask address: 255 . 255 . 255 . 0
- Gateway address: 192 . 168 . 1 . 1
- Mac address: 00-1d-c1-80-53-f7

At the bottom, there are buttons for 'Load...', 'Save...', and 'Factory reset'.

Figure 13: Device Settings Page

2. Set DHCP to **ON** or **OFF**.
3. If DHCP is set to **OFF**, change any of the parameters (IP Address, Netmask and/or Gateway).
4. Click **Set**.



- After changing the IP number, reload the web page with the new IP address.
- After changing the Subnet mask you need to restart the **PA-240Net**.
- If DHCP is checked, reload the web page with the new IP address.

5. Set the UDP and TCP port numbers and click **Set**.

Saving and Loading Settings

To save a configuration:

1. In the Navigation pane, click **Device Settings**.
The Device Settings page appears (see [Figure 13](#)).
2. Click **Save**. The following message appears:
“Configuration file is ready, [right-click here](#) to download”
3. Right-click the link ([right-click here](#)) and click **Save link as**.
The configuration is downloaded to your PC.

To load a configuration:

1. In the Navigation pane, click **Device Settings**.
The Device Settings page appears (see [Figure 13](#)).
2. Click **Load** and browse for the configuration file.
3. Click **Open**.
The configuration loads (this process may take a few minutes to complete)
A message indicating that the configuration uploaded successfully appears.

Performing a Factory Reset

To reset the device to its factory default values:

1. In the Navigation pane, click **Device Settings**.
The Device Settings page appears (see [Figure 13](#)).
2. Click **Factory reset**.
A confirmation warning message appears.
3. Click **OK** to start factory reset and follow the instructions on-screen.

Managing Web Page Security

Use the Authentication page to set Web access permission.

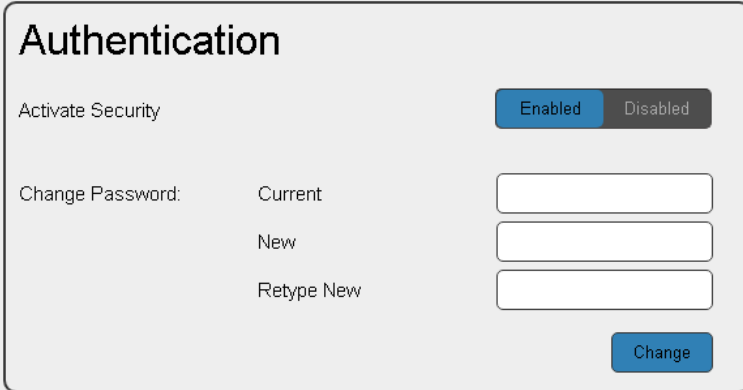

To access Web pages without using the password:

1. In the Navigation pane, click **Security**.
The Authentication page appears (see [Figure 14](#)).



The screenshot shows a web interface titled "Authentication". At the top, there is a section for "Activate Security" with two buttons: "Enabled" (highlighted in blue) and "Disabled". Below this is a "Change Password" section with three input fields labeled "Current", "New", and "Retype New". A "Change" button is located at the bottom right of the form.

Figure 14: Authentication Page

2. Set Activate Security to **Disabled**.
A message prompting for your password appears.
3. Type the current password (Admin by default) and click **OK**.
A message indicating that the password was changed successfully appears.
4. Click **OK**.
The Web page reloads and the web pages are unlocked  .

To access Web pages using the password:

1. In the Navigation pane, click **Security**.
The Authentication page appears (see [Figure 14](#)).
2. Set Activate Security to **Enabled** for Web page password protection.
A confirmation warning message appears:
3. Click **OK**.
The connection is interrupted and authentication is required to access web pages.

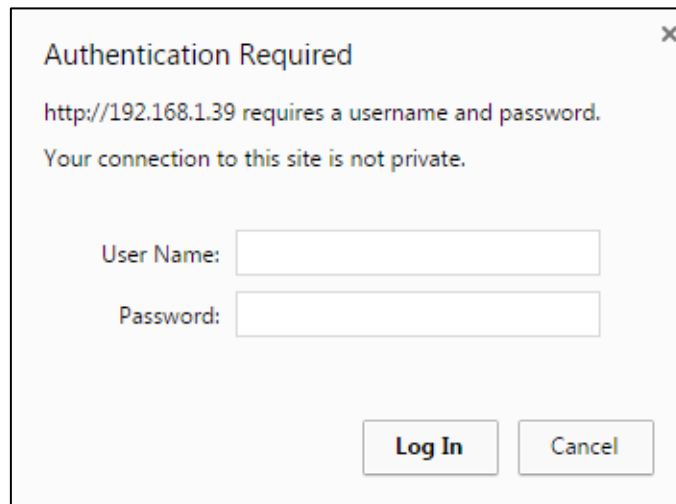



Figure 15: Password Settings Page – Security Log In

4. Type the User Name (Admin, by default) and Password (Admin, by default).
5. Click **Log In**.
6. Select **Security** from the Navigation pane.
The Authentication page appears (see [Figure 14](#)).
7. Type the new authentication password twice in both New and Retype New text boxes.
8. Click **Change**.
A confirmation warning message appears.
9. Click **OK**. The following message appears.
A message indicating that the password was changed successfully appears.
10. Click **OK**.

The web pages are locked  .

Viewing the About Page

The About page lets you view the web page version and Kramer Electronics Ltd details.

Using the Web-based Dante Controller

The PA-240Net can be operated using the Dante Controller, a Web-based software controller application from Audinate. Use the controller to route audio and configure devices on a Dante network. It features automatic device discovery, one-click signal routing and user-editable device and channel labels as well as providing essential device status information and powerful real-time network monitoring.

- Download the Dante Web-based Controller from:
www.audinate.com/products/software/dante-controller
- Download the Dante Web-based controller User Guide from:
<https://dev.audinate.com/GA/dante-controller/userguide/pdf/latest>

Technical Specifications

		PA-240Net	PA-120Net
Inputs	2 Channels, on a Dante™ Net	On an RJ-45 connector	
	1 Balanced Stereo Audio	+4dBu/10kΩ, on a 5-pin terminal block	
Outputs	1 Balanced Stereo Audio	Line level, on a 5-pin terminal block	
	1 Speaker	On a 4-pin large terminal block	
Ports	1 Control via IP	On an RJ-45 connector	
	1 RS-232	On a 3-pin terminal block	
Amplifier	Input Sensitivity:	Full power @ 0.3V (-10dBV)	
	Output Power:	2 x 60W @ 4Ω or 8Ω 1 x 120W @ 70V or 100V	2 x 120W @ 4Ω or 8Ω 1 x 240W @ 70V or 100V
	Class	D	
	Maximum Voltage Gain:	26dB SE / 32dB BTL	
	Dynamic Range	119dB	
	Frequency Response	20Hz to 20kHz @ +/-1dB	
	S/N Ratio:	80dB, 20Hz - 20kHz	
	Audio THD + Noise:	THD+N (1kHz @ 1W) 0.003 %	
Audio 2nd Harmonic:	0.08% @ 75W RMS @ 4Ω 6.67kHz		
Controls		Output volume attenuator, IP and RS-232	
Power	Source:	Universal mains operational voltage 85V AC – 265V AC	Universal mains operational voltage 85V AC – 265V AC (full power at 120V – 230V)
	Consumption	195VA	265VA
	Total System Efficiency	89%	90%
Environmental Conditions	Operating Temperature	0° to +40°C (32° to 104°F)	
	Storage Temperature	-40° to +70°C (-40° to 158°F)	
	Humidity	10% to 90%, RHL non-condensing	
Regulatory Compliance	Safety	CE, FCC	
	Environmental	RoHs, WEEE	
Enclosure	Size	Desktop	
	Type	Aluminum	
	Cooling	Fan ventilation	
General	Net Dimensions (W, D, H)	21.5cm x 16.3cm x 4.4cm (8.5" x 6.4" x 1.7")	
	Shipping Dimensions (W, D, H)	40.5cm x 29.7cm x 9cm (15.9" x 11.7" x 3.5")	
	Net Weight	1.05kg (2.3lbs)	
	Shipping Weight	1.65kg (3.6lbs) approx.	
Included Accessories		Power cord	
Specifications are subject to change without notice at www.kramerav.com			

Default Communication Parameters

RS-232		
Protocol 3000		
Baud Rate:	115,200	
Data Bits:	8	
Stop Bits:	1	
Parity:	None	
Example (change the volume of input 2 to -10 dB):	#AUD-LVL 1,2,-10	
TCP/IP Parameters	Ethernet - Controller	Ethernet - Dante
IP Address:	192.168.1.39	DHCP
Subnet Mask:	255.255.000.000	N/A
Default Gateway:	192.168.0.1	N/A
Maximum UDP Connections:	Unlimited	N/A
Maximum TCP Connections:	Unlimited	N/A
UDP Port #:	50000	N/A
TCP Port #:	5000	N/A
Default Username / Password:	Admin / Admin	N/A
Full Factory Reset		
Protocol 3000	Excluding ETH: use "#FACTORY" command and use "#RESET" to restore the factory default values.	

Protocol 3000

The PA-240Net 240W Power Amplifier can be operated using the Kramer Protocol 3000 serial commands. The command framing varies according to how you interface with the PA-240Net.

Generally, a basic video input switching command that routes a layer 1 video signal to HDMI out 1 from HDMI input 2 (ROUTE 1, 1, 2), is entered as follows:

- Terminal communication software, such as Hercules:

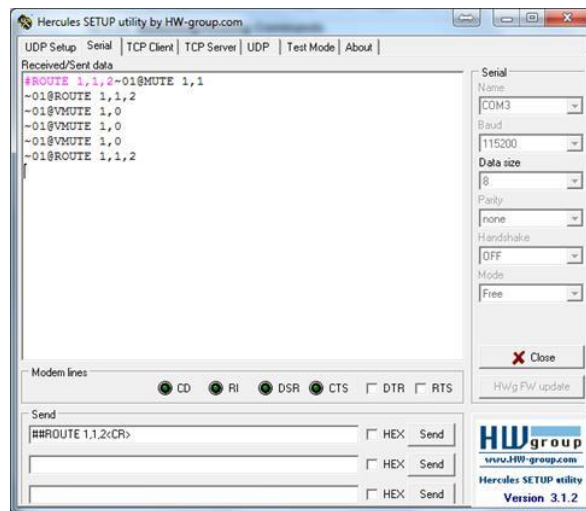

The framing of the command varies according to the terminal communication software.

- K-Touch Builder (Kramer software):

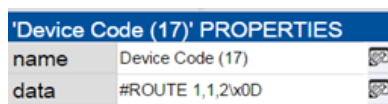

- K-Config (Kramer configuration software):

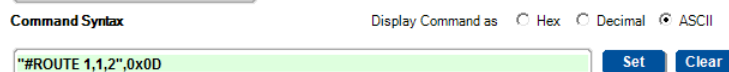

All the examples provided in this section are based on using the K-Config software.

You can enter commands directly using terminal communication software (e.g., Hercules) by connecting a PC to the serial or Ethernet port, depending on your device. To enter `CR` press the Enter key (`LF` is also sent but is ignored by the command parser).

Commands sent from various non-Kramer controllers (e.g., Crestron) may require special coding for some characters (such as, `/X##`). For more information, refer to your controller's documentation.

For more information about Protocol 3000 commands, see:

- [Understanding Protocol 3000](#) on page [25](#).
- [Kramer Protocol 3000 Syntax](#) on page [26](#).
- [Protocol 3000 Commands](#) on page [27](#).

Understanding Protocol 3000

Protocol 3000 commands are structured according to the following:

- Command – A sequence of ASCII letters (A-Z, a-z and -). A command and its parameters must be separated by at least one space.
- Parameters – A sequence of alphanumeric ASCII characters (0-9, A-Z, a-z and some special characters for specific commands). Parameters are separated by commas.
- Message string – Every command entered as part of a message string begins with a message starting character and ends with a message closing character.



A string can contain more than one command. Commands are separated by a pipe (|) character.

- Message starting character:
 - # – For host command/query
 - ~ – For device response
- Device address – K-NET Device ID followed by @ (optional, K-NET only)
- Query sign – ? follows some commands to define a query request
- Message closing character:
 - CR – Carriage return for host messages (ASCII 13)
 - CR LF – Carriage return for device messages (ASCII 13) and line-feed (ASCII 10)
- Command chain separator character – Multiple commands can be chained in the same string. Each command is delimited by a pipe character (|). When chaining commands, enter the message starting character and the message closing character only at the beginning and end of the string.



Spaces between parameters or command terms are ignored. Commands in the string do not execute until the closing character is entered. A separate response is sent for every command in the chain.

Kramer Protocol 3000 Syntax

The Kramer Protocol 3000 syntax uses the following delimiters:

- **CR** = Carriage return (ASCII 13 = 0x0D)
- **LF** = Line feed (ASCII 10 = 0x0A)
- **SP** = Space (ASCII 32 = 0x20)

Some commands have short name syntax in addition to long name syntax to enable faster typing. The response is always in long syntax.

The Protocol 3000 syntax is in the following format:

- **Host Message Format:**

Start	Address (optional)	Body	Delimiter
#	<i>Device_id@</i>	Message	CR

- **Simple Command** – Command string with only one command without addressing:

Start	Body	Delimiter
#	Command SP <i>Parameter_1,Parameter_2,...</i>	CR

- **Command String** – Formal syntax with command concatenation and addressing:

Start	Address	Body	Delimiter
#	<i>Device_id@</i>	Command_1 <i>Parameter1_1,Parameter1_2,...</i> Command_2 <i>Parameter2_1,Parameter2_2,...</i> Command_3 <i>Parameter3_1,Parameter3_2,...</i> ...	CR

- **Device Message Format:**

Start	Address (optional)	Body	Delimiter
~	<i>Device_id@</i>	Message	CR LF

- **Device Long Response** – Echoing command:

Start	Address (optional)	Body	Delimiter
~	<i>Device_id@</i>	Command SP [<i>Param1 Param2 ...</i>] result	CR LF

Protocol 3000 Commands

This section includes the following commands:

- [System Commands](#) on page [27](#).
- [Audio Commands](#) on page [31](#).
- [Communication Commands](#) on page [39](#).

System Commands

All devices running Protocol 3000 use these commands.

Command	Description
#	Protocol handshaking
BUILD-DATE?	Get device build date
FACTORY	Reset to factory default configuration
HELP	Get command list
MODEL?	Get device model
PROT-VER?	Get device protocol version
RESET	Reset device
SN?	Get device serial number
NAME	Set/get machine (DNS) name

#

Functions		Permission	Transparency
Set:	#	End User	Public
Get:	-	-	-
Description		Syntax	
Set:	Protocol handshaking	# <input type="checkbox"/> CR	
Get:	-	-	
Response			
~nn@SPOKCR LF			
Notes			
Validates the Protocol 3000 connection and gets the machine number Step-in master products use this command to identify the availability of a device			
K-Config Example			
"#", 0x0D			

BUILD-DATE?

Functions		Permission	Transparency
Set:	-	-	-
Get:	BUILD-DATE?	End User	Public
Description		Syntax	
Set:	-	-	
Get:	Get device build date	# BUILD-DATE? <input type="checkbox"/> CR	
Response			
~ <input type="checkbox"/> <input type="checkbox"/> @ BUILD-DATE <input type="checkbox"/> SPdate <input type="checkbox"/> SPtime <input type="checkbox"/> CR LF			
Parameters			
date – Format: YYYY/MM/DD where YYYY = Year, MM = Month, DD = Day			
time – Format: hh:mm:ss where hh = hours, mm = minutes, ss = seconds			
K-Config Example			
"#BUILD-DATE?", 0x0D			

FACTORY

Functions		Permission	Transparency
Set:	FACTORY	End User	Public
Get:	-	-	-
Description		Syntax	
Set:	Reset device to factory default configuration	# FACTORY <input type="checkbox"/> CR	
Get:	-	-	
Response			
~ <input type="checkbox"/> <input type="checkbox"/> @ FACTORY <input type="checkbox"/> SPOK <input type="checkbox"/> CR LF			
Notes			
This command deletes all user data from the device. The deletion can take some time. Your device may require powering off and powering on for the changes to take effect.			
K-Config Example			
"#FACTORY", 0x0D			

HELP

Functions		Permission	Transparency
Set:	-	-	-
Get:	HELP	End User	Public
Description		Syntax	
Set:	-	-	
Get:	Get command list or help for specific command	2 options: 1. # HELP <input type="checkbox"/> 2. # HELP <input type="checkbox"/> SPcommand_name <input type="checkbox"/> CR	
Response			
1. Multi-line: ~ <input type="checkbox"/> <input type="checkbox"/> @Device available protocol 3000 commands: <input type="checkbox"/> CR LFcommand <input type="checkbox"/> SPcommand... <input type="checkbox"/> CR LF To get help for command use: HELP (COMMAND_NAME) <input type="checkbox"/> CR LF			
2. Multi-line: ~ <input type="checkbox"/> <input type="checkbox"/> @ HELP <input type="checkbox"/> SPcommand: <input type="checkbox"/> CR LFdescription <input type="checkbox"/> CR LFUSAGE: usage <input type="checkbox"/> CR LF			
Notes			
To get help for a specific command use: HELP <input type="checkbox"/> SPCOMMAND_NAME <input type="checkbox"/> CR LF			
K-Config Example			
"#HELP", 0x0D			

MODEL?

Functions		Permission	Transparency
Set:	–	–	–
Get:	MODEL?	End User	Public
Description		Syntax	
Set:	–	–	
Get:	Get device model	# MODEL? <input type="checkbox"/> CR	
Response			
~ <input type="checkbox"/> <input type="checkbox"/> @ MODEL? <input type="checkbox"/> SP <code>model_name</code> <input type="checkbox"/> CR LF			
Parameters			
<code>model_name</code> – string of up to 19 printable ASCII chars			
Notes			
This command identifies equipment connected to Step-in master products and notifies of identity changes to the connected equipment. The Matrix saves this data in memory to answer REMOTE-INFO requests			
K-Config Example			
"#MODEL?", 0x0D			

PROT-VER?

Functions		Permission	Transparency
Set:	–	–	–
Get:	PROT-VER?	End User	Public
Description		Syntax	
Set:	–	–	
Get:	Get device protocol version	# PROT-VER? <input type="checkbox"/> CR	
Response			
~ <input type="checkbox"/> <input type="checkbox"/> @ PROT-VER? <input type="checkbox"/> SP <code>3000:version</code> <input type="checkbox"/> CR LF			
Parameters			
<code>version</code> – XX.XX where X is a decimal digit			
K-Config Example			
"#PROT-VER?", 0x0D			

RESET

Functions		Permission	Transparency
Set:	RESET	Administrator	Public
Get:	–	–	–
Description		Syntax	
Set:	Reset device	# RESET <input type="checkbox"/> CR	
Get:	–	–	
Response			
~ <input type="checkbox"/> <input type="checkbox"/> @ RESET <input type="checkbox"/> SPOk <input type="checkbox"/> CR LF			
Notes			
To avoid locking the port due to a USB bug in Windows, disconnect USB connections immediately after running this command. If the port was locked, disconnect and reconnect the cable to reopen the port.			
K-Config Example			
"#RESET", 0x0D			

SN?

Functions		Permission	Transparency
Set:	–	–	–
Get:	SN?	End User	Public
Description		Syntax	
Set:	–	–	
Get:	Get device serial number	#SN? <input type="checkbox"/> CR	
Response			
~ <input type="checkbox"/> nn@ <input type="checkbox"/> SN <input type="checkbox"/> SPserial_number <input type="checkbox"/> CR LF			
Parameters			
serial_number – 14 decimal digits, factory assigned			
K-Config Example			
"#SN?",0x0D			

NAME

Functions		Permission	Transparency
Set:	NAME	Administrator	Public
Get:	NAME?	End User	Public
Description		Syntax	
Set:	Set machine (DNS) name	#NAME <input type="checkbox"/> SPmachine_name <input type="checkbox"/> CR	
Get:	Get machine (DNS) name	#NAME? <input type="checkbox"/> CR	
Response			
Set: ~ <input type="checkbox"/> nn@ <input type="checkbox"/> NAME <input type="checkbox"/> SPmachine_name <input type="checkbox"/> CR LF			
Get: ~ <input type="checkbox"/> nn@ <input type="checkbox"/> NAME? <input type="checkbox"/> SPmachine_name <input type="checkbox"/> CR LF			
Parameters			
machine_name – string of up to 15 alpha-numeric chars (can include hyphen, not at the beginning or end)			
Notes			
The machine name is not the same as the model name. The machine name is used to identify a specific machine or a network in use (with DNS feature on)			
K-Config Example			
Set the DNS name of the device to "room-442": "#NAME room-442",0x0D			

Audio Commands

These commands are used by audio devices running Protocol 3000.

Command	Description
AUD-CH-LINK	Set/get link between master configuration and slave/state
AUD-CLIP?	Get clipping status
AUD-FILTER	Set/get filter/state
AUD-HI-Z?	Get High Z status
AUD-IN-CONF	Set/get threshold and time
AUD-LVL	Set/get audio level in specific amplifier stage
AUD-MIX	Set/get mixer level
AUD-MONO-MODE	Set/get output select state when audio in HI-Z mode only
AUD-SIGNAL?	Get audio input signal status
AUD-STANDBY	Set/get standby mode/state
BALANCE	Set/get balance level
EQ-FREQ	Set/get equalizer center
EQ-LVL	Set/get equalization level
EQ-Q	Set/get Q level
MUTE	Set/get audio mute

AUD-CH-LINK

Functions		Permission	Transparency
Set:	AUD-CH-LINK	End User	Public
Get	AUD-CH-LINK?	End User	Public
Description		Syntax	
Set:	Set link between master configuration and slave	#AUD-CH-LINK ^{SP} Ch1,Ch2,LinkState ^{CR}	
Get:	Get the configuration link state	#AUD-CH-LINK?Ch1 ^{CR}	
Response			
~nn@AUD-CH-LINK ^{SP} Ch1,Ch2,LinkState ^{CR LF}			
Parameters			
Ch1 – 1 (Speaker Output)			
Ch2 – 2 (Line Level Output)			
LinkState – 1 (enable), 0 (disable)			
Notes			
Response if no link - AUD-CH-LINK 1,1,0			
Response if link - AUD-CH-LINK 1,2,1			
K-Config Example			
Set a link between the speaker output configuration and the line level output configuration: "#AUD-CH-LINK 1,2,1",0x0D			

AUD-CLIP?

Functions		Permission	Transparency
Set:	–	–	–
Get	AUD-CLIP?	End User	Public
Description		Syntax	
Set:	–	–	
Get:	Get clipping status	#AUD-CLIP? [SP] Channel [CR]	
Response			
~ [nn] @AUD-CLIP [SP] Channel,ClipStatus [CR LF]			
Parameters			
Channel – 1 (Speaker Output), 2 (Line Level Output) ClipStatus – 1 (Clipping detected), 0 (Clipping not detected)			
K-Config Example			
Get the speaker output channel clipping status: "#AUD-CLIP? 1",0x0D			

AUD-FILTER

Functions		Permission	Transparency
Set:	AUD-FILTER	End User	Public
Get	AUD-FILTER?	End User	Public
Description		Syntax	
Set:	Set filter	#AUD-FILTER [SP] Channel,FilterType,Freq,State [CR]	
Get:	Get filter state	#AUD-FILTER? [SP] Channel [CR]	
Response			
~ [nn] @AUD-FILTER [SP] Channel,FilterType,Freq,State [CR LF]			
Parameters			
Channel – 1 (Speaker Output), 2 (Line Level Output) FilterType – Filter type: 0 (High pass filter) Freq – Filter frequency: 0 (T: 10kHz, M: 500Hz, B: 60Hz), 1 (T: 12.5kHz, M: 1kHz, B: 80Hz), 2 (T: 15kHz, M: 1.5kHz, B: 500Hz), 3 (T: 17.5kHz, M: 2.5kHz, B: 200Hz) State – 1 (On), 0 (Off)			
Notes			
T=Treble, M=Middle, B=Bass			
K-Config Example			
Set the audio filter on the speaker output on to high-pass filter, T: 10kHz, M: 500Hz, B: 60Hz: "#AUD-FILTER 1,0,0,1",0x0D			

AUD-HI-Z

Functions		Permission	Transparency
Set:	–	–	–
Get	AUD-HI-Z?	End User	Public
Description		Syntax	
Set:	–	–	
Get:	Get High Z status	#AUD-HI-Z? CR	
Response			
~nn@AUD-HI-Z SP Channel,HiZState,HiZVolt CR LF			
Parameters			
Channel – 1 (Speaker Output), 2 (Line Level Output) HiZState – 1 (Hi-Z state high), 0 (Hi-Z state low) HiZVolt – Hi-Z volt level: 0 (70 Volt), 1 (100 Volt), 0xff (Ignore). Optional, active only in high state			
Notes			
Active only when state is high. Ignore everything else.			
K-Config Example			
Set the line level output to Hi-Z and 70V: "#AUD-HI-Z 2,1,0",0x0D			

AUD-IN-CONF

Functions		Permission	Transparency
Set:	AUD-IN-CONF	End User	Public
Get	AUD-IN-CONF?	End User	Public
Description		Syntax	
Set:	Set threshold and time to indicate when signal is presents or not.	#AUD-IN-CONF SP Channel,ThresholdDbLevel,TrigTimeDelay CR	
Get:	Get threshold and time	#AUD-IN-CONF? CR Channel	
Response			
~nn@AUD-IN-CONF SP Channel,ThresholdDbLevel,TrigTimeDelay CR LF			
Parameters			
Channel – 1 (Speaker Output), 2 (Line Level Output) ThresholdDbLevel – input level indicating when a signal is not present, range -100 to 0dB TrigTimeDelay – 10 (fixed)			
K-Config Example			
Set the speaker output threshold level and time: "#AUD-IN-CONF 1,-50,10",0x0D			

AUD-LVL

Functions		Permission	Transparency
Set:	AUD-LVL	End User	Public
Get:	AUD-LVL?	End User	Public
Description		Syntax	
Set:	Set volume level	#AUD-LVL[SP]stage,channel,volume,mutebehavior[CR]	
Get:	Get volume level	#AUD-LVL?[SP]stage,channel[CR]	
Response			
~nn@AUD-LVL[SP]stage,channel,volume[CR LF]			
Parameters			
stage – 1 (For output processing)			
channel – 1 (Speaker Output), 2 (Line Level Output)			
volume – volume level -80db to 10dB			
mutebehavior – optional, 1 (changing the volume does not affect the mute state)			
K-Config Example			
Set the speaker output audio level to -50dB: "#AUD-LVL 1,1,-50",0x0D			

AUD-MIX

Functions		Permission	Transparency
Set:	AUD-MIX	End User	Public
Get:	AUD-MIX?	End User	Public
Description		Syntax	
Set:	Set mixer level	#AUD-MIX[SP]channel,knob,level[CR]	
Get:	Get mixer level	#AUD-MIX?[SP]channel,knob[CR]	
Response			
~nn@AUD-MIX[SP]channel,knob,level[CR LF]			
Parameters			
channel – 1 (Speaker Output), 2 (Line Level Output)			
knob – mixer knob number: 1 (Input 1), 2 (Input 2)			
level – mixer level: -80 to 10dB			
K-Config Example			
Set the input mixing level of input 2 on the speaker output to -48dB: "#AUD-MIX 1,2,-48",0x0D			

AUD-MONO-MODE

Functions		Permission	Transparency
Set:	AUD-MONO-MODE	End User	Public
Get	AUD-MONO-MODE?	End User	Public
Description		Syntax	
Set:	Set output select state when audio in HI-Z mode only	#AUD-MONO-MODE[SP]MonoMode[CR]	
Get:	Get output select state when audio in HI-Z mode only	#AUD-MONO-MODE?[CR]	
Response			
~nn@AUD-MONO-MODE[SP]MonoMode[CR LF]			
Parameters			
<i>MonoMode</i> – The mono output mode: 0 (output is "stereo mix to mono" – both left and right mix to one channel), 1 (output is "left to mono" – duplicate left channel information to the right and play both)			
Notes			
These commands are active only when the state is HI-Z, otherwise an error is returned. To set, the <i>MonoMode</i> parameter must be used.			
K-Config Example			
Set the output to mix to mono: "#AUD-MONO-MODE 0",0x0D			

AUD-SIGNAL

Functions		Permission	Transparency
Set:	–	–	–
Get	AUD-SIGNAL?	End User	Public
Description		Syntax	
Set:	–	–	
Get:	Get audio input signal status	#AUD-SIGNAL?[SP]inp_id[CR]	
Response			
~nn@AUD-SIGNAL[SP]inp_id,status[CR LF]			
Parameters			
<i>Inp_id</i> – input number: 1 (Input 1), 2 (Input 2) <i>status</i> – 0 (OFF, no signal), 1 (ON, signal present)			
Response Triggers			
After execution, response is sent to the com port from which the Get was received Response is sent to all com ports if audio status state was changed on any input			
K-Config Example			
get the status of input 1: "#AUD-SIGNAL? 1",0x0D			

AUD-STANDBY

Functions		Permission	Transparency
Set:	AUD-STANDBY	End User	Public
Get:	AUD-STANDBY?	End User	Public
Description		Syntax	
Set:	Set standby mode	#AUD-STANDBY[SP]StandbyMode,TimeDelay[CR]	
Get:	Get standby mode state	#AUD-STANDBY?[CR]	
Response			
~nn@AUD-STANDBY[SP]StandbyMode,TimeDelay[CR LF]			
Parameters			
<i>StandbyMode</i> – 0 (Off), 1 (Delayed, auto mode), 2 (Standby mode)			
<i>TimeDelay</i> – 5, 10, or 15 (time delay [min] to standby mode)			
Notes			
Active only in auto mode			
K-Config Example			
Set the standby delay time to 10 minutes: "#AUD-STANDBY 1,10",0x0D			

BALANCE

Functions		Permission	Transparency
Set:	BALANCE	End User	Public
Get:	BALANCE?	End User	Public
Description		Syntax	
Set:	Set balance level	#BALANCE[SP]channel,balancelevel[CR]	
Get:	Get balance level	#BALANCE?[SP]channel[CR]	
Response			
~nn@BALANCE[SP]channel,balance_level[CR LF]			
Parameters			
<i>channel</i> – 1 (Speaker output), 2 (Line level output)			
<i>balancelevel</i> – -15 to +15 (audio parameter in Kramer units, minus sign precedes negative values)			
++ increase current value			
-- decrease current value			
K-Config Example			
Set the speaker output balance to +12: "#BALANCE 1,12",0x0D			

EQ-FREQ

Functions		Permission	Transparency
Set:	EQ-FREQ	End User	Public
Get	EQ-FREQ?	End User	Public
Description		Syntax	
Set:	Set equalizer frequency	#EQ- FREQ[SP]Stage,Channel,EqType,EqFreq[CR]	
Get:	Get equalizer frequency	#EQ- FREQ?[SP]Stage,Channel,EqType[CR]	
Response			
~nn@EQ- FREQ[SP]Stage,Channel,EqType,EqFreq[CR LF]			
Parameters			
<i>Stage</i> – 1 (Output) <i>Channel</i> – 1 (Speaker output), 2 (Line Level Output) <i>EqType</i> – 0 (Bass), 1 (Middle), 2 (Treble) <i>EqFreq</i> – 0 (T: 10kHz, M: 500Hz, B: 60Hz), 1 (T: 12.5kHz, M: 1kHz, B: 80Hz), 2 (T: 15kHz, M: 1.5kHz, B: 500Hz), 3 (T: 17.5kHz, M: 2.5kHz, B: 200Hz)			
Notes			
T=Treble, M=Middle, B=Bass			
K-Config Example			
Set speaker output equalizer frequency on the bass to 200Hz: "#EQ-FREQ 1,1,0,3",0x0D			

EQ-LVL

Functions		Permission	Transparency
Set:	EQ-LVL	End User	Public
Get:	EQ-LVL?	End User	Public
Description		Syntax	
Set:	Set equalization level	#EQ-LVL[SP]Stage,Channel,EqType,Level[CR]	
Get :	Get equalization level	#EQ-LVL?[SP]Stage,Channel,EqType[CR]	
Response			
~nn@EQ-LVL[SP]Stage,Channel,EqType,Level[CR LF]			
Parameters			
<i>Stage</i> – 1 (Output processing) <i>Channel</i> – 1 (Speaker output), 2 (Line level output) <i>EqType</i> – 0 (Bass), 1 (Middle), 2 (Treble) <i>Level</i> –equalizer level			
K-Config Example			
Set Bass EQ level of the speaker output to 12: "#EQ-LVL 1,1,0,12",0x0D			

EQ-Q

Functions		Permission	Transparency
Set:	EQ-Q	End User	Public
Get:	EQ-Q?	End User	Public
Description		Syntax	
Set:	Set Q level	#EQ-Q[SP]Channel,EqType,Q_level[CR]	
Get:	Get Q level	#EQ-Q?[SP]Channel,EqType[CR]	
Response			
~nn@EQ-Q[SP]Channel,EqType,Q_level[CR LF]			
Parameters			
Channel – 1 (Speaker output), 2 (Line level output)			
EqType – 0 (Bass), 1 (Middle), 2 (Treble)			
Q_level – 0 to 15 (Q level)			
K-Config Example			
Set the line level output treble Q level to 8: "#EQ-Q 1,2,8 4",0x0D			

MUTE

Functions		Permission	Transparency
Set:	MUTE	End User	Public
Get:	MUTE?	End User	Public
Description		Syntax	
Set:	Set audio mute	#MUTE[SP]channel,mute_mode[CR]	
Get:	Get audio mute	#MUTE?[SP]channel[CR]	
Response			
~nn@MUTE[SP]channel,mute_mode[CR LF]			
Parameters			
channel – 1 (Speaker output), 2 (Line level output)			
mute_mode – 0 (Off), 1 (On)			
K-Config Example			
Set speaker output to mute: "#MUTE 1,1",0x0D			

Communication Commands

These commands are used by network devices running Protocol 3000.

Command	Description
NET-CONFIG	Set/get a network configuration
ETH-PORT	Set/get Ethernet port protocol
NET-DHCP	Set/get DHCP mode
NET-MAC?	Get MAC address

NET-CONFIG

Functions		Permission	Transparency
Set:	NET-CONFIG	End User	Public
Get:	NET-CONFIG?	End User	Public
Description		Syntax	
Set:	Set a network configuration.	#NET-CONFIG <i>SP</i> <i>id,ip,net_mask,gateway</i> <i>CR LF</i>	
Get:	Get a network configuration.	#NET-CONFIG? <i>SP</i> <i>id</i> <i>CR LF</i>	
Response			
Get:	~ <i>nn</i> @NET-CONFIG <i>SP</i> <i>id,ip,net_mask,gateway</i> <i>CR LF</i>		
Parameters			
<i>id</i> – network ID			
<i>ip</i> – network IP			
<i>net_mask</i> – network mask			
<i>gateway</i> – network gateway			
K-Config Example			
"#NET-CONFIG 1,192.168.113.10,255.255.0.0,192.168.0.1",0x0D			

ETH-PORT

Functions		Permission	Transparency
Set:	ETH-PORT	Administrator	Public
Get:	ETH-PORT?	End User	Public
Description		Syntax	
Set:	Set Ethernet port protocol	#ETH-PORT <i>SP</i> <i>portType,ETHPort</i> <i>CR</i>	
Get:	Get Ethernet port protocol	#ETH-PORT? <i>SP</i> <i>portType</i> <i>CR</i>	
Response			
~ <i>nn</i> @ETH-PORT <i>SP</i> <i>portType,ETHPort</i> <i>CR LF</i>			
Parameters			
<i>portType</i> – 0 (TCP), 1 (UDP)			
<i>ETHPort</i> – 0-65534 (TCP / UDP port number)			
Notes			
If the port number you enter is already in use, an error is returned. The port number must be within the following range: 2000-(2 ¹⁶ -1). UDP port 50001 and TCP port 5001 are reserved for internal use.			
K-Config Example			
Set the Ethernet port protocol for TCP to port 12457: "#ETH-PORT 0,12457",0x0D			

NET-DHCP

Functions		Permission	Transparency
Set:	NET-DHCP	Administrator	Public
Get:	NET-DHCP?	End User	Public
Description		Syntax	
Set:	Set DHCP mode	#NET-DHCP SP mode CR	
Get:	Get DHCP mode	#NET-DHCP? CR	
Response			
~nn@NET-DHCP SP mode CR LF			
Parameters			
<i>mode</i> –			
0 (do not use DHCP. Use the IP address set by the factory or the NET-IP command),			
1 (try to use DHCP. If unavailable, use the IP address set by the factory or the NET-IP command)			
Notes			
Connecting Ethernet to devices with DHCP may take more time in some networks			
To connect with a randomly assigned IP by DHCP, specify the device DNS name (if available) using the command "NAME". You can also get an assigned IP by direct connection to USB or RS-232 protocol port if available			
For proper settings consult your network administrator			
K-Config Example			
Enable DHCP mode, if available: "#NET-DHCP 1", 0x0D			

NET-MAC?

Functions		Permission	Transparency
Set:	–	–	–
Get:	NET-MAC?	End User	Public
Description		Syntax	
Set:	–	–	
Get:	Get MAC address	#NET-MAC? CR	
Response			
~nn@NET-MAC SP mac_address CR LF			
Parameters			
<i>mac_address</i> – Unique MAC address. Format: XX-XX-XX-XX-XX-XX where X is hex digit			
K-Config Example			
"#NET-MAC?", 0x0D			

The warranty obligations of Kramer Electronics Inc. ("Kramer Electronics") for this product are limited to the terms set forth below:

What is Covered

This limited warranty covers defects in materials and workmanship in this product.

What is Not Covered

This limited warranty does not cover any damage, deterioration or malfunction resulting from any alteration, modification, improper or unreasonable use or maintenance, misuse, abuse, accident, neglect, exposure to excess moisture, fire, improper packing and shipping (such claims must be presented to the carrier), lightning, power surges, or other acts of nature. This limited warranty does not cover any damage, deterioration or malfunction resulting from the installation or removal of this product from any installation, any unauthorized tampering with this product, any repairs attempted by anyone unauthorized by Kramer Electronics to make such repairs, or any other cause which does not relate directly to a defect in materials and/or workmanship of this product. This limited warranty does not cover cartons, equipment enclosures, cables or accessories used in conjunction with this product.

Without limiting any other exclusion herein, Kramer Electronics does not warrant that the product covered hereby, including, without limitation, the technology and/or integrated circuit(s) included in the product, will not become obsolete or that such items are or will remain compatible with any other product or technology with which the product may be used.

How Long this Coverage Lasts

The standard limited warranty for Kramer products is seven (7) years from the date of original purchase, with the following exceptions:

1. All Kramer VIA hardware products are covered by a standard three (3) year warranty for the VIA hardware and a standard three (3) year warranty for firmware and software updates.
2. All Kramer fiber optic cables, adapter-size fiber optic extenders, active cables, cable retractors, all Kramer speakers and Kramer touch panels are covered by a standard one (1) year warranty.
3. All Kramer Cobra products, all Kramer Calibre products, all Kramer Minicom digital signage products, all HighSecLabs products, all streaming, and all wireless products are covered by a standard three (3) year warranty.
4. All Sierra Video MultiViewers are covered by a standard five (5) year warranty.
5. Sierra switchers & control panels are covered by a standard seven (7) year warranty (excluding power supplies and fans that are covered for three (3) years).
6. K-Touch software is covered by a standard one (1) year warranty for software updates.
7. All Kramer passive cables are covered by a ten (10) year warranty.

Who is Covered

Only the original purchaser of this product is covered under this limited warranty. This limited warranty is not transferable to subsequent purchasers or owners of this product.

What Kramer Electronics Will Do

Kramer Electronics will, at its sole option, provide one of the following three remedies to whatever extent it shall deem necessary to satisfy a proper claim under this limited warranty:

1. Elect to repair or facilitate the repair of any defective parts within a reasonable period of time, free of any charge for the necessary parts and labor to complete the repair and restore this product to its proper operating condition. Kramer Electronics will also pay the shipping costs necessary to return this product once the repair is complete.
2. Replace this product with a direct replacement or with a similar product deemed by Kramer Electronics to perform substantially the same function as the original product.
3. Issue a refund of the original purchase price less depreciation to be determined based on the age of the product at the time remedy is sought under this limited warranty.

What Kramer Electronics Will Not Do Under This Limited Warranty

If this product is returned to Kramer Electronics or the authorized dealer from which it was purchased or any other party authorized to repair Kramer Electronics products, this product must be insured during shipment, with the insurance and shipping charges prepaid by you. If this product is returned uninsured, you assume all risks of loss or damage during shipment. Kramer Electronics will not be responsible for any costs related to the removal or re-installation of this product from or into any installation. Kramer Electronics will not be responsible for any costs related to any setting up this product, any adjustment of user controls or any programming required for a specific installation of this product.

How to Obtain a Remedy Under This Limited Warranty

To obtain a remedy under this limited warranty, you must contact either the authorized Kramer Electronics reseller from whom you purchased this product or the Kramer Electronics office nearest you. For a list of authorized Kramer Electronics resellers and/or Kramer Electronics authorized service providers, visit our web site at www.kramerav.com or contact the Kramer Electronics office nearest you.

In order to pursue any remedy under this limited warranty, you must possess an original, dated receipt as proof of purchase from an authorized Kramer Electronics reseller. If this product is returned under this limited warranty, a return authorization number, obtained from Kramer Electronics, will be required (RMA number). You may also be directed to an authorized reseller or a person authorized by Kramer Electronics to repair the product.

If it is decided that this product should be returned directly to Kramer Electronics, this product should be properly packed, preferably in the original carton, for shipping. Cartons not bearing a return authorization number will be refused.

Limitation of Liability

THE MAXIMUM LIABILITY OF KRAMER ELECTRONICS UNDER THIS LIMITED WARRANTY SHALL NOT EXCEED THE ACTUAL PURCHASE PRICE PAID FOR THE PRODUCT. TO THE MAXIMUM EXTENT PERMITTED BY LAW, KRAMER ELECTRONICS IS NOT RESPONSIBLE FOR DIRECT, SPECIAL, INCIDENTAL OR CONSEQUENTIAL DAMAGES RESULTING FROM ANY BREACH OF WARRANTY OR CONDITION, OR UNDER ANY OTHER LEGAL THEORY. Some countries, districts or states do not allow the exclusion or limitation of relief, special, incidental, consequential or indirect damages, or the limitation of liability to specified amounts, so the above limitations or exclusions may not apply to you.

Exclusive Remedy

TO THE MAXIMUM EXTENT PERMITTED BY LAW, THIS LIMITED WARRANTY AND THE REMEDIES SET FORTH ABOVE ARE EXCLUSIVE AND IN LIEU OF ALL OTHER WARRANTIES, REMEDIES AND CONDITIONS, WHETHER ORAL OR WRITTEN, EXPRESS OR IMPLIED. TO THE MAXIMUM EXTENT PERMITTED BY LAW, KRAMER ELECTRONICS SPECIFICALLY DISCLAIMS ANY AND ALL IMPLIED WARRANTIES, INCLUDING, WITHOUT LIMITATION, WARRANTIES OF MERCHANTABILITY AND FITNESS FOR A PARTICULAR PURPOSE. IF KRAMER ELECTRONICS CANNOT LAWFULLY DISCLAIM OR EXCLUDE IMPLIED WARRANTIES UNDER APPLICABLE LAW, THEN ALL IMPLIED WARRANTIES COVERING THIS PRODUCT, INCLUDING WARRANTIES OF MERCHANTABILITY AND FITNESS FOR A PARTICULAR PURPOSE, SHALL APPLY TO THIS PRODUCT AS PROVIDED UNDER APPLICABLE LAW. IF ANY PRODUCT TO WHICH THIS LIMITED WARRANTY APPLIES IS A "CONSUMER PRODUCT" UNDER THE MAGNUSON-MOSS WARRANTY ACT (15 U.S.C.A. §2301, ET SEQ.) OR OTHER APPLICABLE LAW, THE FOREGOING DISCLAIMER OF IMPLIED WARRANTIES SHALL NOT APPLY TO YOU, AND ALL IMPLIED WARRANTIES ON THIS PRODUCT, INCLUDING WARRANTIES OF MERCHANTABILITY AND FITNESS FOR THE PARTICULAR PURPOSE, SHALL APPLY AS PROVIDED UNDER APPLICABLE LAW.

Other Conditions

This limited warranty gives you specific legal rights, and you may have other rights which vary from country to country or state to state.

This limited warranty is void if (i) the label bearing the serial number of this product has been removed or defaced, (ii) the product is not distributed by Kramer Electronics or (iii) this product is not purchased from an authorized Kramer Electronics reseller. If you are unsure whether a reseller is an authorized Kramer Electronics reseller, visit our web site at www.kramerav.com or contact a Kramer Electronics office from the list at the end of this document.

Your rights under this limited warranty are not diminished if you do not complete and return the product registration form or complete and submit the online product registration form. Kramer Electronics thanks you for purchasing a Kramer Electronics product. We hope it will give you years of satisfaction.



P/N:



2900-301040

Rev:



2



SAFETY WARNING

Disconnect the unit from the power supply before opening and servicing

For the latest information on our products and a list of Kramer distributors, visit our Web site where updates to this user manual may be found.

We welcome your questions, comments, and feedback.