

USER MANUAL

MODEL:

FC-18 Display Controller



Contents

Introduction	1
Getting Started	1
Overview	2
Typical Applications	3
Defining FC-18 Display Controller	4
Mounting FC-18	6
Connecting FC-18	7
Connecting Remote Control Switches	8
Connecting to FC-18 via RS-232	8
Connecting to FC-18 via Ethernet	9
Controlling the FC-18	12
Controlling the Display via FC-18	13
Controlling the Display via HDMI OUT Port (CEC)	14
Controlling the Display via its RS-232 Port	21
Controlling the Display via the Network (Ethernet)	28
Using the Embedded Web Pages	36
Viewing General Information	38
Changing Device Settings	38
Defining Video and Audio Settings	42
Managing EDID	43
Setting RS-232 Port and Toggle Remote Switch Functions	45
Configuring CEC Commands	50
Controlling an External Device via Ethernet	52
Setting Web Page Access Permission	54
Viewing About Us Page	56
Firmware Upgrade	57
Technical Specifications	58
Default EDID	58
Default Communication Parameters	61
Protocol 3000	62
Understanding Protocol 3000	62
Protocol 3000 Commands	63
Result and Error Codes	68

Introduction

Welcome to Kramer Electronics! Since 1981, Kramer Electronics has been providing a world of unique, creative, and affordable solutions to the vast range of problems that confront the video, audio, presentation, and broadcasting professional on a daily basis. In recent years, we have redesigned and upgraded most of our line, making the best even better!

Getting Started

We recommend that you:

- Unpack the equipment carefully and save the original box and packaging materials for possible future shipment.
- Review the contents of this user manual.



Go to www.kramerav.com/downloads/FC-18 to check for up-to-date user manuals, application programs, and to check if firmware upgrades are available (where appropriate).

Achieving the Best Performance

- Use only good quality connection cables (we recommend Kramer high-performance, high-resolution cables) to avoid interference, deterioration in signal quality due to poor matching, and elevated noise levels (often associated with low quality cables).
- Do not secure the cables in tight bundles or roll the slack into tight coils.
- Avoid interference from neighboring electrical appliances that may adversely influence signal quality.
- Position your Kramer **FC-18** away from moisture, excessive sunlight and dust.

Safety Instructions



Caution:

- This equipment is to be used only inside a building. It may only be connected to other equipment that is installed inside a building.
- For products with relay terminals and GPIO ports, please refer to the permitted rating for an external connection, located next to the terminal or in the User Manual.
- There are no operator serviceable parts inside the unit.



Warning:

- Use only the power cord that is supplied with the unit.
- To ensure continuous risk protection, replace fuses only according to the rating specified on the product label which located on the bottom of the unit.

Recycling Kramer Products

The Waste Electrical and Electronic Equipment (WEEE) Directive 2002/96/EC aims to reduce the amount of WEEE sent for disposal to landfill or incineration by requiring it to be collected and recycled. To comply with the WEEE Directive, Kramer Electronics has made arrangements with the European Advanced Recycling Network (EARN) and will cover any costs of treatment, recycling and recovery of waste Kramer Electronics branded equipment on arrival at the EARN facility. For details of Kramer's recycling arrangements in your particular country go to our recycling pages at www.kramerav.com/support/recycling.

Overview

Congratulations on purchasing your Kramer **FC-18 Display Controller**. **FC-18** is a display ON/OFF controller for 4K@60Hz (4:4:4) HDR HDMI™ signals. It accepts and outputs an HDMI signal after reclocking and equalizing.

FC-18 can be used to control a display device manually via front panel buttons, contact closure switches and via RS-232 and Ethernet serial commands.

On detection of the onset of an input signal, **FC-18** sends an ON command to the display or projector, and on detection of the loss of the input signal, **FC-18** sends an OFF command.

FC-18 provides exceptional quality, advanced and user-friendly operation, and flexible control.

Exceptional Quality

- High-Performance HDMI Acceptor – Supports 4K@60Hz (4:4:4) HDR10, HDCP 2.2/1.4 signals at 18G (6G per channel) data rate, CEC (bypass), Dolby Vision (bypass) as specified in HDMI 2.0.

Advanced and User-friendly Operation

- Facilitates Meeting Setups – Just plug in the AV source and the display screen or projector automatically turn on. No more searching for the power button.
- Variety of Automatic Control Formats – Commands are sent to the display device via CEC, RS-232, or Ethernet.
- Variety of Manual Control Formats – Manually turn the display device ON and OFF via front panel buttons and RS-232/CEC commands, Ethernet and contact closure switches.
- Efficient Power-Saving – Shuts down display devices automatically when not in use.
- Firmware Upgrade – Ethernet or USB based, via a user-friendly software upgrade tool.

Flexible Connectivity

- Data Tunneling – Supports RS-232 data tunneling over Ethernet.
- Easy Installation – Compact DigiTOOLS® fan-less enclosure for surface mounting or side-by-side mounting of 3 units in a 1U rack space with the recommended rack adapter.



FC-18 supports CEC functionality and has been tested and verified with many display models. Kramer cannot guarantee CEC compatibility with all CEC displays due to command variations and proprietary commands implemented by some manufacturers in some of their displays.

Typical Applications

FC-18 is ideal for the following typical applications:

- Small meeting spaces.
- Projection systems in conference rooms, boardrooms, auditoriums, hotels and churches, production studios, rental and staging.
- Ethernet-based control applications where the installation uses an RS-232 controlled or CEC supported projector.

Controlling your FC-18

Control your **FC-18** via:

- RS-232 serial commands transmitted by a touch screen system, PC, or other serial controller.
- Ethernet using built-in user-friendly Web pages.
- The front panel push buttons.
- Remote contact-closure switches (for example, a proximity switch).

Defining FC-18 Display Controller

This section defines FC-18.

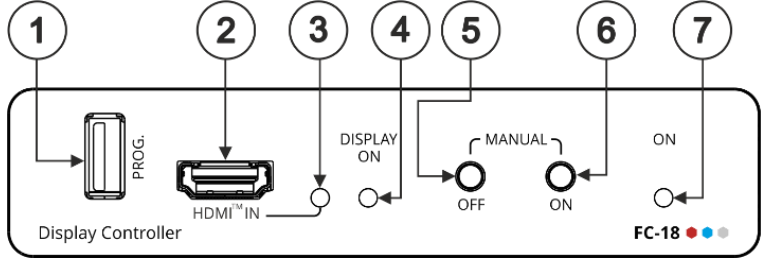



Figure 1: FC-18 Display Controller Front Panel

#	Feature	Function	
①	PROG USB Connector	Connect to update the firmware.	
②	HDMI™ IN	Connector	Connect to an HDMI source.
③		LED	Lights green when a valid HDMI signal is detected. Detection is based on the presence of 5V and a clock signal on the HDMI input.
④	DISPLAY ON LED		Lights green when the HDMI acceptor on the output is on.
⑤	MANUAL	OFF Button	Press to instruct FC-18 to send a CEC OFF (or RS-232 or Ethernet) command to the display. The display remains off (and the DISPLAY ON LED is off) even if the input conditions dictate to turn the display on. Only after detecting no input signal for a period of over 5 minutes will the trigger-defined input conditions be able to turn the display on once again. Press and hold for 3 seconds for full factory reset.
⑥		ON Button	Press to instruct FC-18 to send a CEC ON (or RS-232 or Ethernet) command to the display. The display remains on (and the DISPLAY ON LED is on) for an interval of a minimum of 5 minutes. After that time-period, the trigger-defined input conditions will dictate to shut the display down. Press and hold for 3 seconds to enter firmware upgrade mode (see Firmware Upgrade on page 57).
	 On/off behavior remains the same whether the display is set to ON/OFF manually or via serial communications. Press both ON and OFF buttons simultaneously to show the current device IP address on the display.		
⑦	ON LED	Lights green when power is connected.	

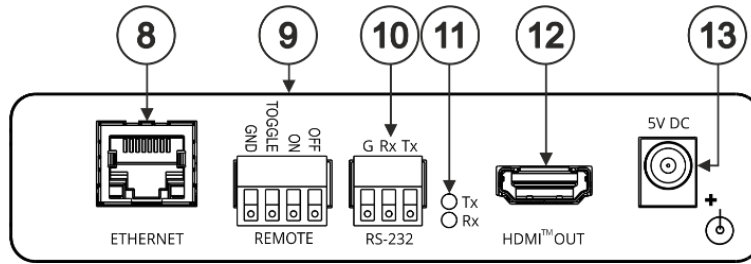

Figure 2: FC-18 Display Controller Rear Panel

#	Feature	Function
⑧	Ethernet RJ-45 Port	Connect to a PC via a LAN to control the device, send commands to the display, or tunnel RS-232 data to the display. Also use for firmware upgrade.
⑨	REMOTE 4-pin Terminal Block Connector	Connect to contact closure switches (by momentary contact between the desired pin and GND pin), see Connecting Remote Control Switches on page 8. TOGGLE – one button toggles between display ON and display OFF (instead of using two separate buttons for ON and OFF). The button can be set for edge triggering (momentary connection) or for level triggering (constant contact connection), see Setting the Toggle Pin Function on page 45. ON – turns the display on. OFF – turns the display off.
⑩	RS-232 3-pin Terminal Block Connectors (G, Rx, Tx)	Set the function of the RS-232 port via the webpages: Connect to the display to send RS-232 commands to the display (default) via web pages, for example. OR Connect to a PC or remote controller to control FC-18 (for example, instructing it to send a CEC command to turn the display on or off).
⑪	Tx LED	Lights red when RS-232 port transmits data.
	Rx LED	Lights green when RS-232 Port receives data.
⑫	HDMI™ OUT Connector	Connect to a CEC enabled HDMI acceptor.
⑬	5V DC Power Connector	Connect to the supplied power adapter.

Mounting FC-18

This section provides instructions for mounting **FC-18**. Before installing, verify that the environment is within the recommended range:



- Operation temperature – 0° to 40°C (32 to 104°F).
- Storage temperature – -40° to +70°C (-40 to +158°F).
- Humidity – 10% to 90%, RHL non-condensing.



- **FC-18** must be placed upright in the correct horizontal position.



Caution:

- Mount **FC-18** before connecting any cables or power.



Warning:

- Ensure that the environment (e.g., maximum ambient temperature & air flow) is compatible for the device.
- Avoid uneven mechanical loading.
- Appropriate consideration of equipment nameplate ratings should be used for avoiding overloading of the circuits.
- Reliable earthing of rack-mounted equipment should be maintained.

Mount FC-18 in a rack:

Use the recommended rack adapter
(see www.kramerav.com/product/FC-18).

Mount FC-18 on a surface using one of the following methods:

- Attach the rubber feet and place the unit on a flat surface.
- Fasten a bracket (included) on each side of the unit and attach it to a flat surface. For more information go to www.kramerav.com/downloads/FC-18.

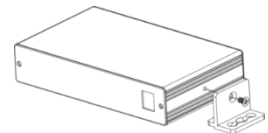

Connecting FC-18



Always switch off the power to each device before connecting it to your **FC-18**. After connecting your **FC-18**, connect its power and then switch on the power to each device.

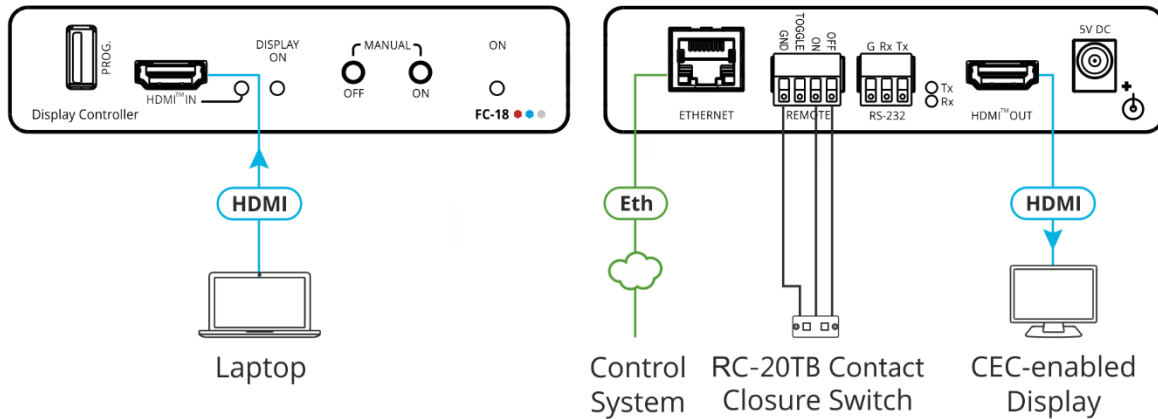

Figure 3: Connecting to FC-18

To connect the FC-18 as illustrated in the example in [Figure 3](#):

1. Connect an HDMI source (for example, a laptop) to the HDMI™ IN connector (2) on the front panel.
2. Connect the HDMI™ OUT connector (12) to an HDMI acceptor (for example, a CEC-enabled display).
3. Connect the REMOTE 4-pin terminal block connector (9) to contact closure switches (for example, Kramer RC-20TB).
4. Connect the ETHERNET RJ-45 port (8) to the Ethernet to control the FC-18 or to tunnel RS-232 data to the display. Also use for firmware upgrade.
5. Connect the power adapter to the FC-18 and to the mains electricity (not shown in [Figure 3](#)).
6. Press the ON and OFF buttons simultaneously to display the current device IP address of the FC-18 on the HDMI acceptor.

Connecting Remote Control Switches

FC-18 includes 3 remote control switches (9). Use contact closure remote control (also known as push-to-make momentary contact) to momentarily connect the desired pin to the GND pin to select one of the following operations:

Pin Name	Function
TOGGLE	Toggle between ON and OFF.
ON	Turn the display ON.
OFF	Turn the display OFF.



Instead of a push-to-make switch, TOGGLE may be configured to operate with a standard SPST switch or for TTL level detection (for example, to use with an occupancy sensor). See [Setting the Toggle Pin Function](#) on page 45.

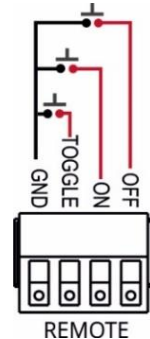

The Toggle pin function can be defined via the RS-232 & Remote embedded webpage (see [Setting the Toggle Pin Function](#) on page 45). By default, the display toggles on or off when momentarily connected. By setting the Toggle function, you can set the pin for level-triggering rather than edge-triggering (i.e., constant contact connection rather than momentary connection), allowing, for example, connection to an occupancy sensor that triggers the toggle commands.

Connecting to FC-18 via RS-232

You can connect to the FC-18 via an RS-232 connection (10) using, for example, a PC.

The FC-18 features an RS-232 3-pin terminal block connector allowing the RS-232 to control the FC-18.

Connect the RS-232 terminal block on the rear panel of the FC-18 to a PC/controller, as follows:

From the RS-232 9-pin D-sub serial port connect:

- Pin 2 to the TX pin on the FC-18 RS-232 terminal block.
- Pin 3 to the RX pin on the FC-18 RS-232 terminal block.
- Pin 5 to the G pin on the FC-18 RS-232 terminal block.

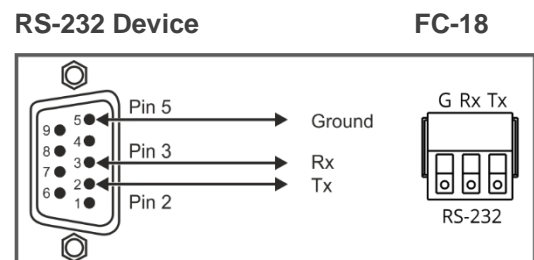

Connecting to FC-18 via Ethernet

You can connect to the **FC-18** via Ethernet using either of the following methods:

- Directly to the PC using a crossover cable (see [Connecting the Ethernet Port Directly to a PC](#) on page 9).
- Via a network hub, switch, or router, using a straight-through cable (see [Connecting the Ethernet Port via a Network Hub or Switch](#) on page 11).



If you want to connect via a router and your IT system is based on IPv6, speak to your IT department for specific installation instructions.

Connecting the Ethernet Port Directly to a PC

You can connect the Ethernet port of the **FC-18** directly to the Ethernet port on your PC using a crossover cable with RJ-45 connectors.



This type of connection is recommended for identifying the **FC-18** with the factory configured default IP address.



Press the front panel ON and OFF buttons simultaneously to show the current device IP address on the display connected to the HDMI output of the **FC-18**.

After connecting the **FC-18** to the Ethernet port, configure your PC as follows:

1. Click **Start > Control Panel > Network and Sharing Center**.
2. Click **Change Adapter Settings**.
3. Highlight the network adapter you want to use to connect to the device and click **Change settings of this connection**.

The Local Area Connection Properties window for the selected network adapter appears as shown in [Figure 4](#).

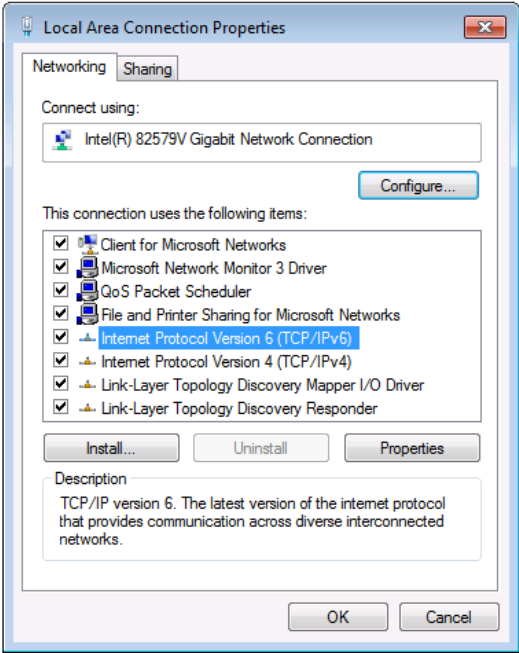

Figure 4: Local Area Connection Properties Window

- 4. Highlight either **Internet Protocol Version 6 (TCP/IPv6)** or **Internet Protocol Version 4 (TCP/IPv4)** depending on the requirements of your IT system.
- 5. Click **Properties**.

The Internet Protocol Properties window relevant to your IT system appears as shown in [Figure 5](#) or [Figure 6](#).

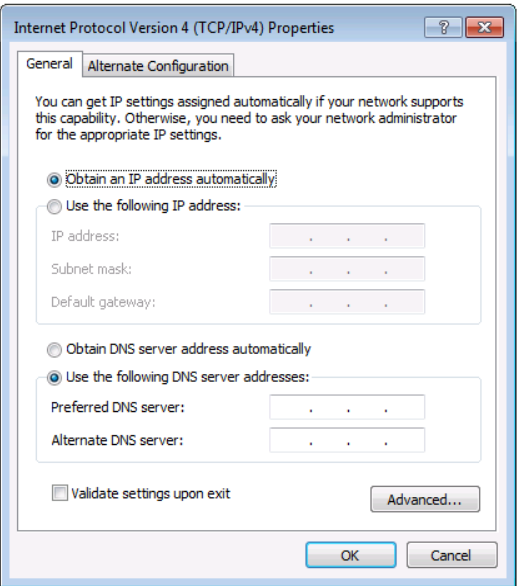

Figure 5: Internet Protocol Version 4 Properties Window

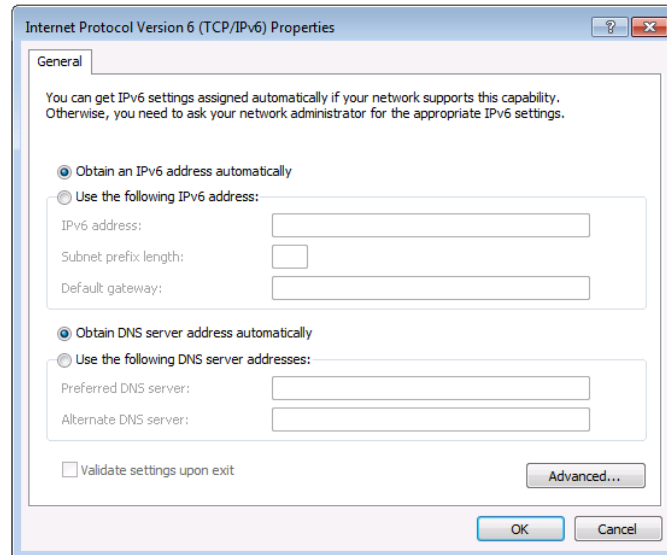

Figure 6: Internet Protocol Version 6 Properties Window

6. Select **Use the following IP Address** for static IP addressing and fill in the details as shown in [Figure 7](#).

For TCP/IPv4 you can use any IP address in the range 192.168.1.1 to 192.168.1.255 (excluding 192.168.1.39) that is provided by your IT department.

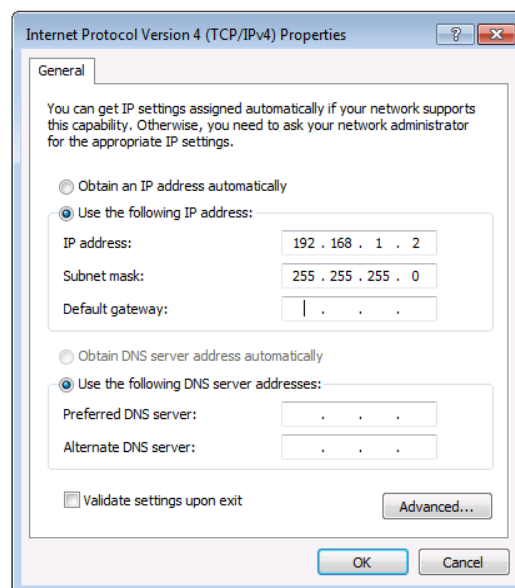

Figure 7: Internet Protocol Properties Window

7. Click **OK**.
8. Click **Close**.

Connecting the Ethernet Port via a Network Hub or Switch

You can connect the Ethernet port of the FC-18 to the Ethernet port on a network hub or using a straight-through cable with RJ-45 connectors.

Configuring the Ethernet Port

You can set the Ethernet parameters via the embedded webpages (see [Using the Embedded Web Pages](#) on page 36).

Controlling the FC-18

You can control **FC-18** via:

- RS-232 port and/or Ethernet by sending protocol commands (see [Protocol 3000](#) on page [62](#)).
- Embedded web pages (see [Using the Embedded Web Pages](#) on page [36](#)).

Control **FC-18** by connecting a laptop or controller to the RS-232 port.

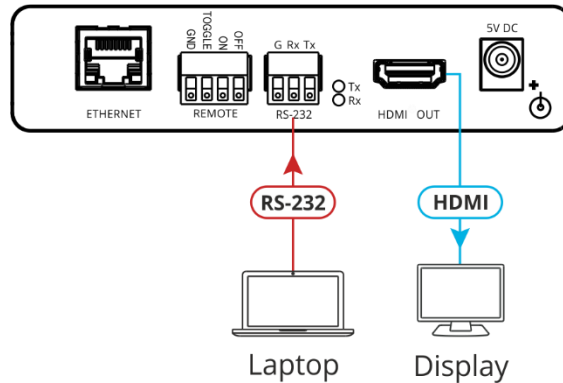

Figure 8: Controlling FC-18 via RS-232 Port

To control the device:

1. Connect a controller to the **FC-18** RS-232 port (10) to control the device.
2. In the Navigation pane, click **RS-232 & Remote**. The RS-232 & Remote page appears.
3. Check Port Definition to **FC-18 Control**.
4. Send protocol commands to control the device.

The device is controlled via RS-232.

Controlling the Display via FC-18

Control the display that is connected to the HDMI OUT connector on the **FC-18** via HDMI, RS-232 or via the Ethernet (mainly, turning it on/off). You can select one of several control methods to enable **FC-18** control the connected display.

To control the display via FC-18:

1. Choose the **FC-18** connection to the display.
2. Choose the user control method via **FC-18**.
3. Wire and configure the system according to the appropriate configuration in the table below:

		FC-18 Controls Display Using		
		HDMI (CEC)	RS-232	Ethernet
User Control Method Via FC-18	RS-232	See Controlling Via RS-232 (FC-18 Sends CEC to HDMI OUT) on page 14 .	N/A	N/A
	Ethernet	See Controlling Via Ethernet (FC-18 Sends CEC to HDMI OUT) on page 16 .	See Controlling the Display using Ethernet (Sending to the Display's RS-232 Port) on page 22 .	See Controlling the Display from the Network (Sending CEC to the Display) on page 29 .
	Front-panel buttons	See Controlling Via Front Panel Buttons (FC-18 Sends CEC to HDMI OUT) on page 16 .	See Controlling the Display via FC-18's Front Panel Buttons (Sending to the Display's RS-232 Port) on page 23 .	See Controlling the Display from the Front Panel Buttons (Sending Ethernet to the Display) on page 29 .
	Remote buttons	See Controlling Via REMOTE ON/OFF Pins (FC-18 Sends CEC to HDMI OUT) on page 17 .	See Controlling the Display via FC-18's REMOTE ON/OFF Pins (Sending to the Display's RS-232 Port) on page 24 .	See Controlling the Display from REMOTE ON/OFF Pins (Sending Ethernet to the Display) on page 31 .
	Occupancy sensor / GPO	See Controlling Via REMOTE TOGGLE Pin (FC-18 Sends CEC to HDMI OUT) on page 18 .	See Controlling the Display via FC-18's REMOTE TOGGLE Pin (Sending to the Display's RS-232 Port) on page 26 .	See Controlling the Display from REMOTE TOGGLE Pin (Sending Ethernet to the Display) on page 32 .
	Automatic control (video input sensing)	See Controlling the Display Automatically (Sending CEC to HDMI OUT) on page 19 .	See Controlling the Display Automatically via the RS-232 Port on page 27 .	See Controlling the Display Automatically via the Ethernet Port on page 34 .



In the following sections, the acceptor that is connected to HDMI OUT is referred to as “the display” but this also implies “the projector” or any other acceptor type.

Controlling the Display via HDMI OUT Port (CEC)

You can control a CEC-enabled display via CEC commands in any of the following ways:

- [Controlling Via RS-232 \(FC-18 Sends CEC to HDMI OUT\)](#) on page 14.
- [Controlling Via Ethernet \(FC-18 Sends CEC to HDMI OUT\)](#) on page 16.
- [Controlling Via Front Panel Buttons \(FC-18 Sends CEC to HDMI OUT\)](#) on page 16.
- [Controlling Via REMOTE ON/OFF Pins \(FC-18 Sends CEC to HDMI OUT\)](#) on page 17.
- [Controlling Via REMOTE TOGGLE Pin \(FC-18 Sends CEC to HDMI OUT\)](#) on page 18.
- [Controlling the Display Automatically \(Sending CEC to HDMI OUT\)](#) on page 19.

If your display does not include CEC features, you can send display on/off commands via the RS-232 port (see [Controlling the Display via its RS-232 Port](#) on page 21) or the Ethernet port (see [Controlling the Display via the Network \(Ethernet\)](#) on page 28).

Controlling Via RS-232 (FC-18 Sends CEC to HDMI OUT)

You can send an FC-18 CEC command to the display via the HDMI port by connecting a laptop or controller to the RS-232 port on FC-18.

To control the display by RS-232 via HDMI:

1. Connect a controller to the FC-18 RS-232 port (10) and the HDMI port (12) to the CEC-enabled display.

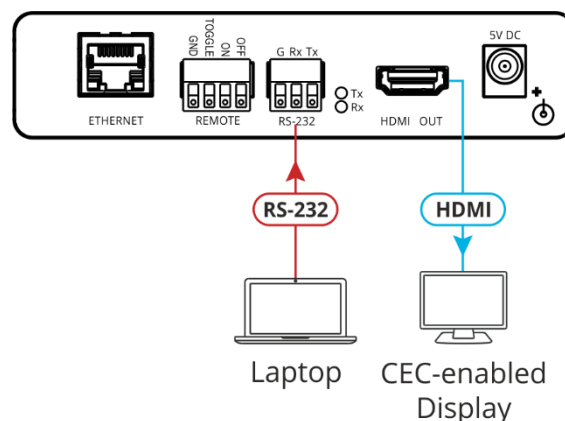

Figure 9: Sending a CEC Command via RS-232 Port

2. In the Navigation pane, click **RS-232 & Remote**. The RS-232 & Remote page appears.

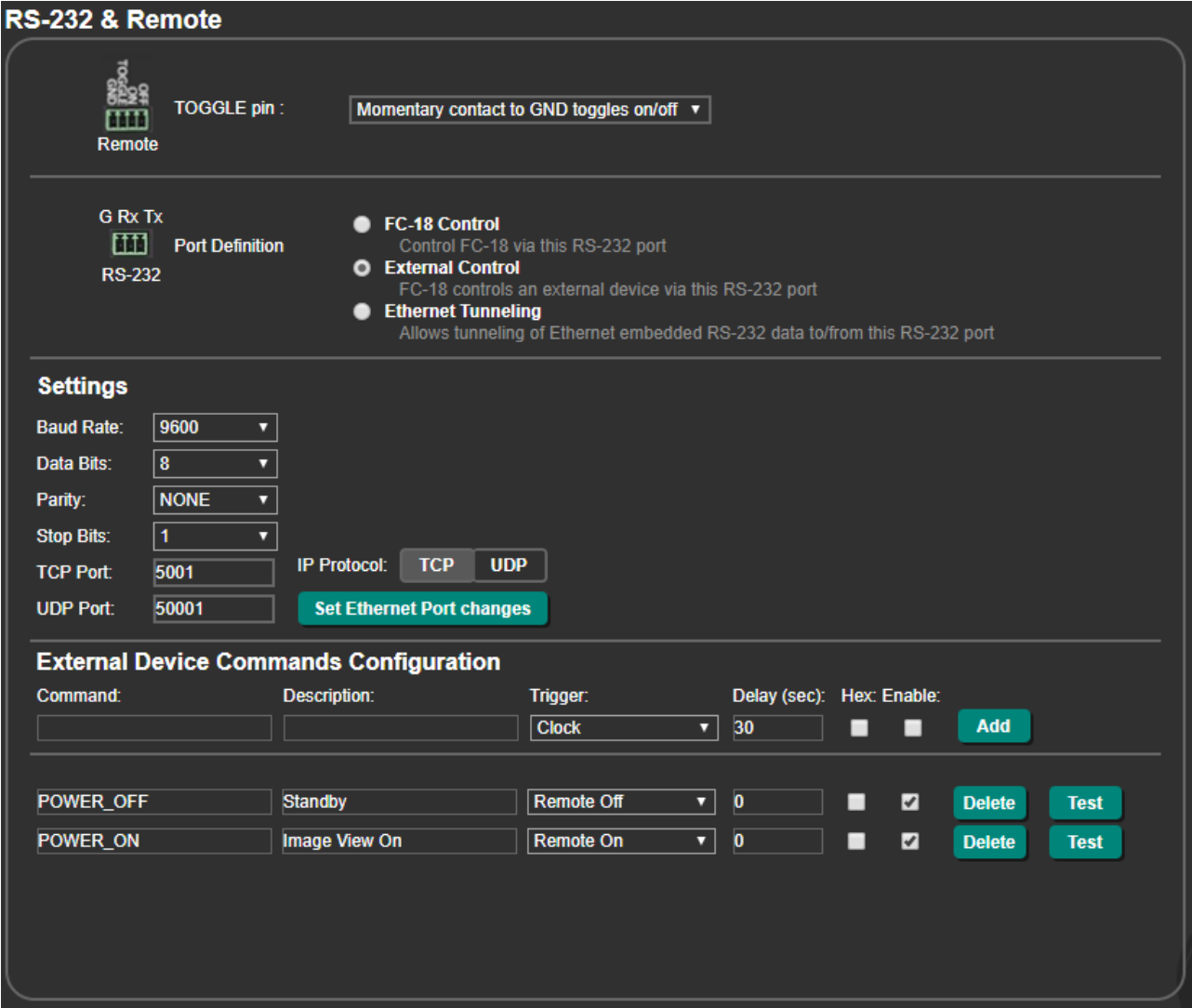

Figure 10: RS-232 & Remote Page

3. Check Port Definition to **FC-18 Control**.

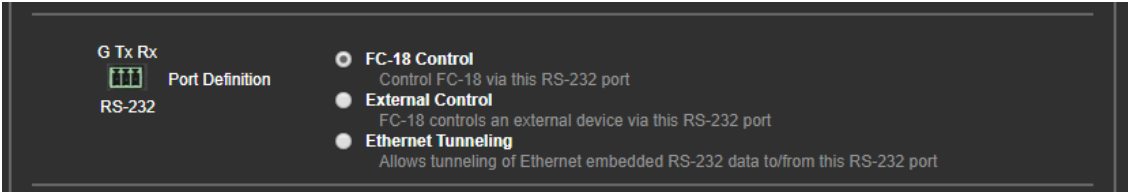

Figure 11: RS-232 & Remote Page – RS-232 Controls FC-18

4. Send the CEC protocol command to control the display (see [Protocol 3000 Commands](#) on page 63).

The display is controlled by RS-232 via the HDMI port.

Controlling Via Ethernet (FC-18 Sends CEC to HDMI OUT)

You can send a CEC command to the display via the HDMI port by connecting a laptop or controller to the Ethernet port on FC-18.

To control the display by Ethernet via HDMI:

1. Connect a controller to the FC-18 Ethernet port (8) and the HDMI port (12) to the CEC-enabled display.

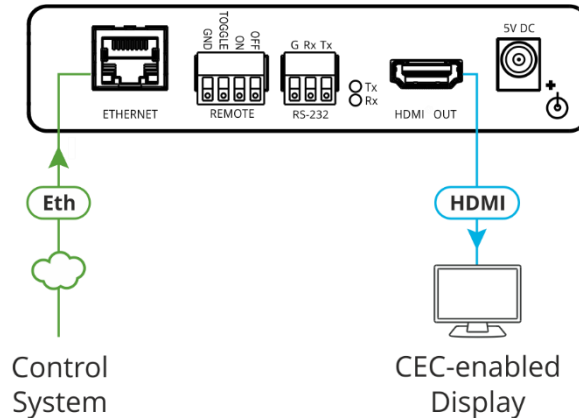

Figure 12: Sending CEC Command via Ethernet Port

2. Send the CEC protocol command to control the display (see [Protocol 3000 Commands](#) on page 63).

The display is controlled by Ethernet via the HDMI port.

Controlling Via Front Panel Buttons (FC-18 Sends CEC to HDMI OUT)

You can turn the display on or off using the front panel buttons.

To control the display using the ON/OFF buttons via HDMI:

1. Connect the HDMI port (12) to the CEC-enabled display.

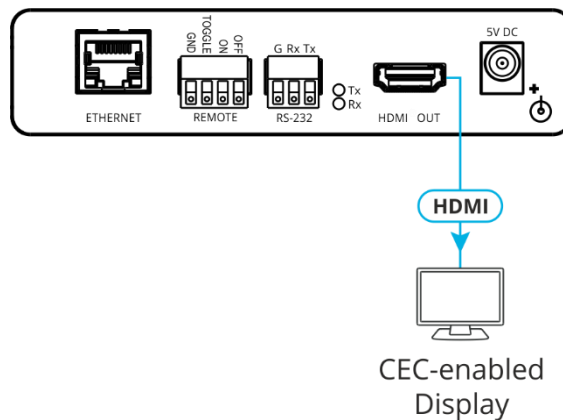

Figure 13: Sending Commands by ON/OFF Buttons via HDMI Connector

- In the Navigation pane, click **CEC**. The CEC Configuration page appears.

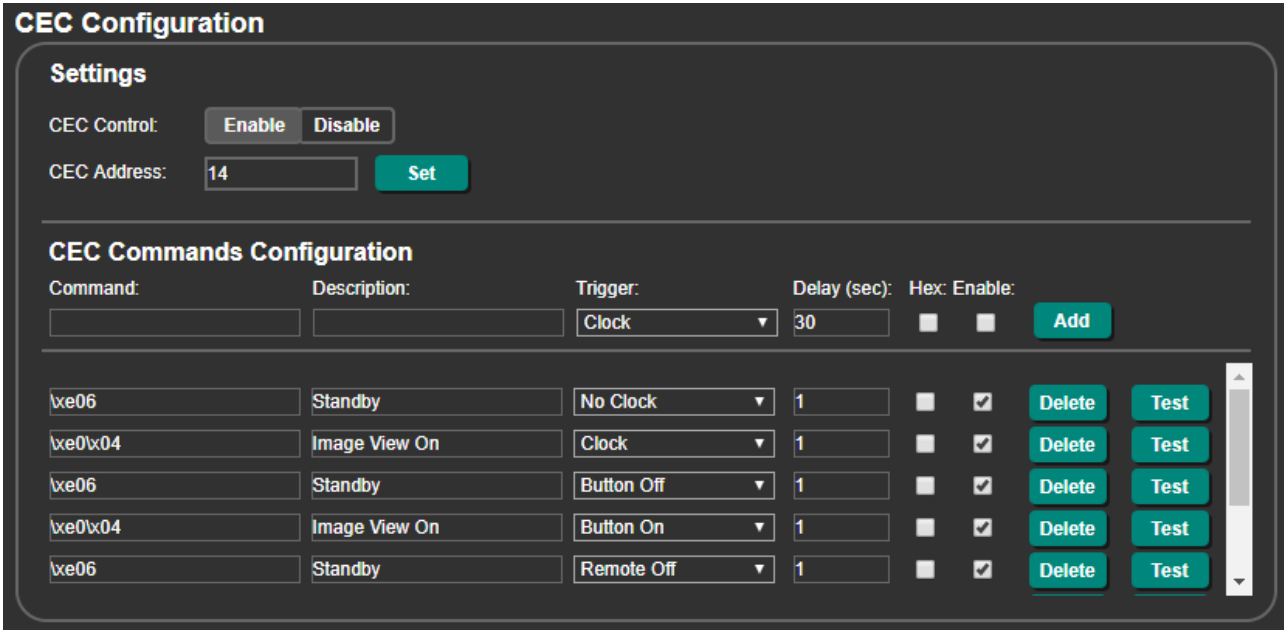

Figure 14: CEC Configuration Page – Button On and Button Off Command Configuration

- Check that the Button On and Button Off commands are defined correctly and enabled.
- Press **ON/OFF** on the front panel to turn the display on or off.

The display is controlled via ON and OFF buttons on the front panel.

For further details, see [Configuring CEC Commands](#) on page 50.

Controlling Via REMOTE ON/OFF Pins (FC-18 Sends CEC to HDMI OUT)

You can turn the display on or off via the contact closure REMOTE ON and OFF pins or TOGGLE pin.

To control the display using the REMOTE ON/OFF pins via HDMI:

- Connect the REMOTE ON, OFF and GND pins (or TOGGLE and GND pins) (9) to remote control buttons and the HDMI port (12) to the CEC-enabled display.

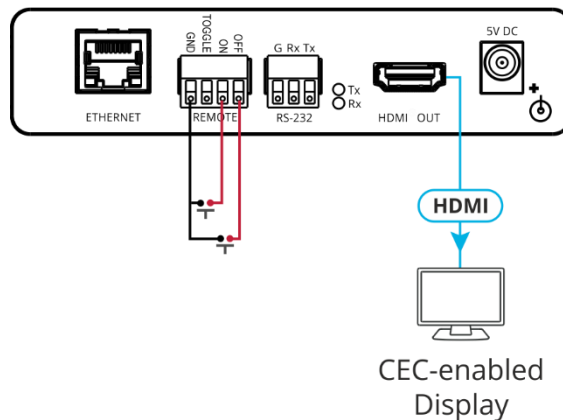

Figure 15: Sending REMOTE ON/OFF Commands via HDMI Connector



If you are using the TOGGLE pin, select the TOGGLE pin function via the RS-232 & Remote page (see [Setting the Toggle Pin Function](#) on page 45).

- In the Navigation pane, click **CEC**. The CEC Configuration page appears.

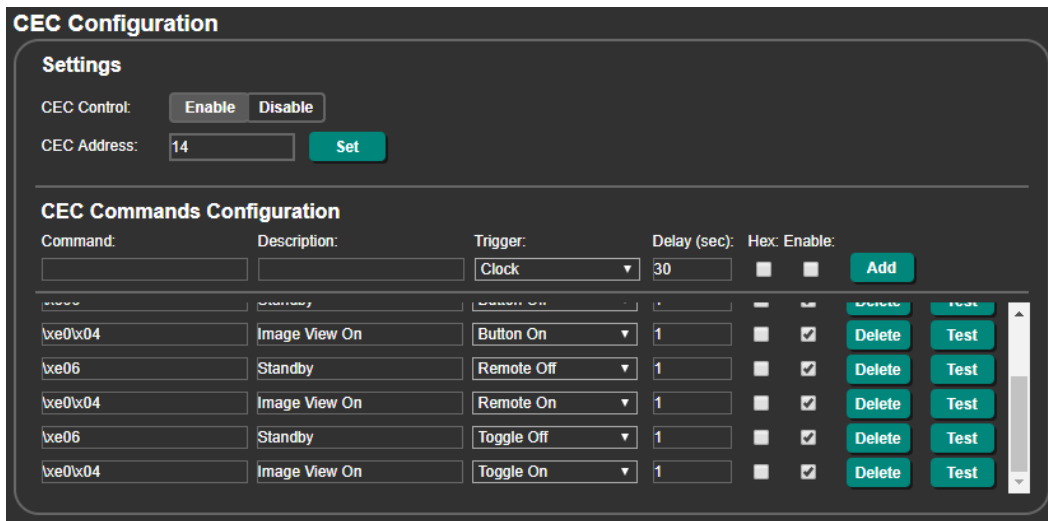

Figure 16: CEC Configuration Page – Remote On and Remote Off Command Configuration

- Check that the Remote On and Remote Off commands are defined correctly and enabled.
- Momentarily connect an ON or OFF pin to the G pin to turn the display on or off.

The display is controlled via ON and OFF buttons on the front panel.

For further details, see [Configuring CEC Commands](#) on page 50.

Controlling Via REMOTE TOGGLE Pin (FC-18 Sends CEC to HDMI OUT)

You can turn the display on or off via the REMOTE contact closure TOGGLE pin that is connected, for example, to an occupancy sensor.

To control the display using the REMOTE TOGGLE pins via HDMI:

- Connect the REMOTE TOGGLE and GND pins ⑨ to remote control buttons and the HDMI port ⑫ to the CEC-enabled display.

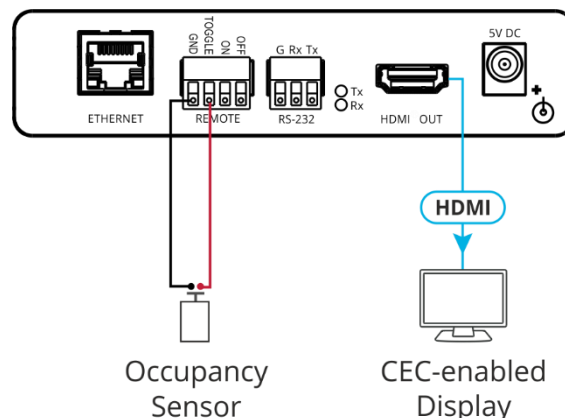

Figure 17: Sending Occupancy-Sensor Triggered Commands via HDMI Connector

- In the Navigation page, click **RS-232 & Remote**. The RS-232 & Remote page appears.
- Select the behavior of the TOGGLE pin from the drop-down list.
For example, for an occupancy sensor, select a Switch closed/Switch open setting.

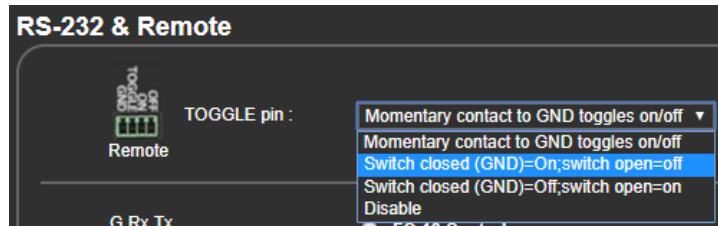

Figure 18: RS-232 & Remote Page – Setting the TOGGLE Pin

- In the Navigation pane, click **CEC**. The CEC Configuration page appears.

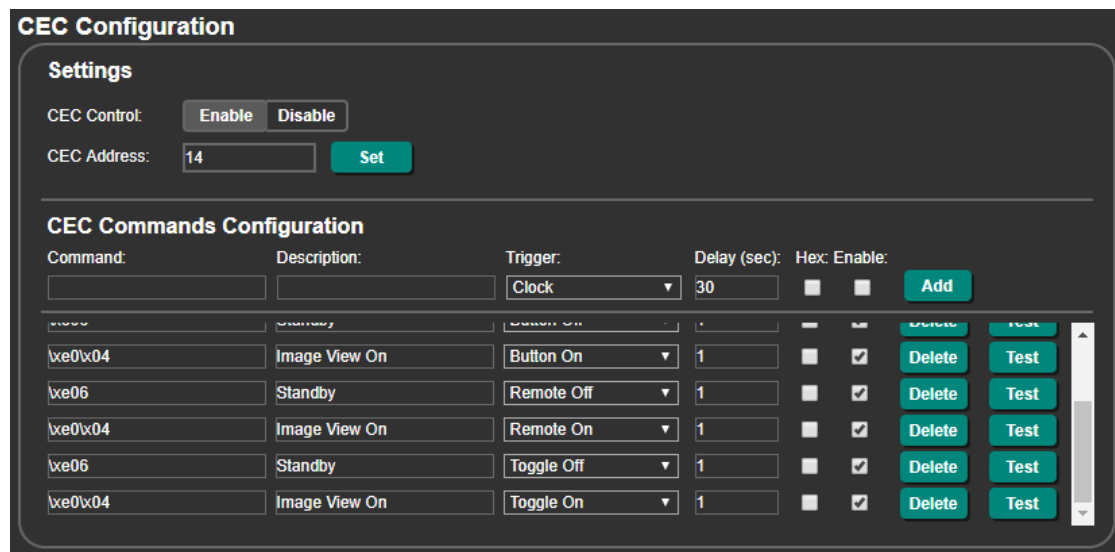

Figure 19: CEC Configuration Page – Toggle On and Toggle Off Command Configuration

- Check that the Toggle On and Toggle Off commands are defined correctly and enabled.

The occupancy sensor, connected to the TOGGLE pin, controls the display.

For further details, see [Configuring CEC Commands](#) on page 50.

Controlling the Display Automatically (Sending CEC to HDMI OUT)

You can turn the display on or off automatically when an HDMI signal is present or lost via the presence of 5V and/or clock signal on or off.



In the example shown below, when the unit detects no signal (no clock) on the HDMI input, it turns the display off by sending the CEC OFF command (\xe06).

When the unit detects that the HDMI signal (clock) returns, it turns the display on by sending the CEC ON command (\xe0\x04).

To control the display automatically via HDMI:

- 1. Connect the HDMI port (12) to the CEC-enabled display.

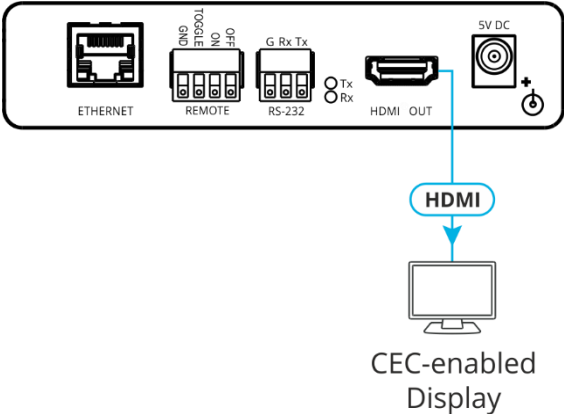

Figure 20: Sending Automatic Commands via HDMI Connector

- 2. In the Navigation pane, click **Video & Audio**. The Video & Audio page appears.

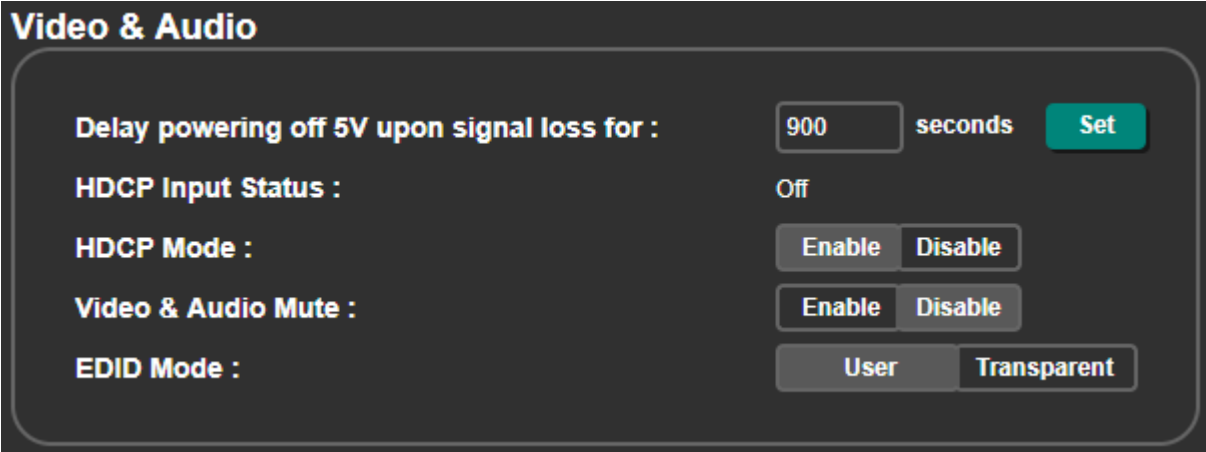

Figure 21: Video & Audio Page – Setting 5V Off Signal-Loss Delay Time

- 3. Enter the 5V powering off delay time and click **Set**.

- In the Navigation pane, click **CEC**. The CEC Configuration page appears.

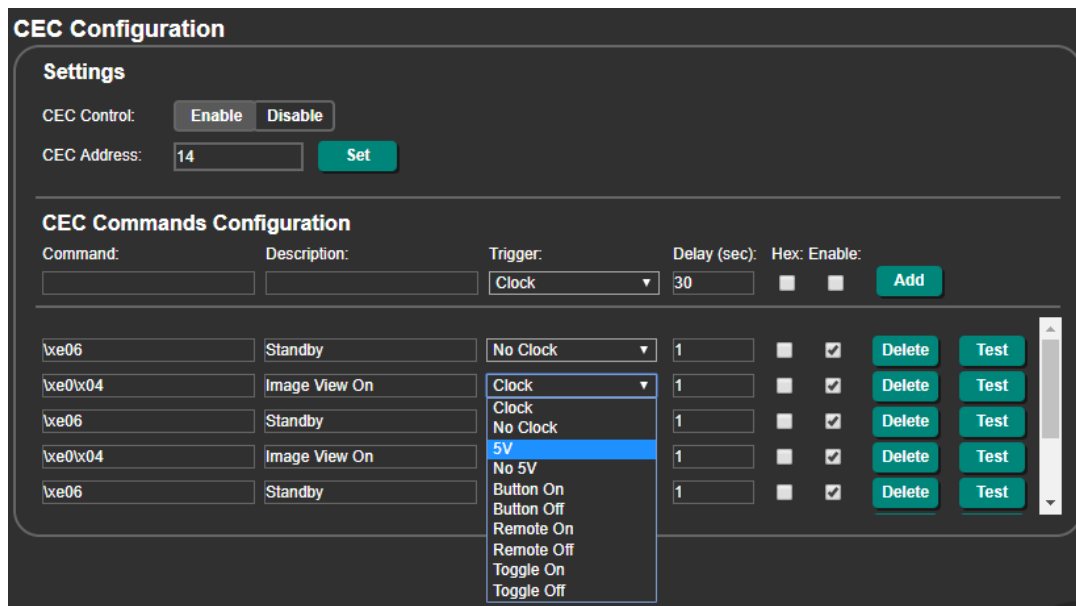

Figure 22: CEC Configuration Page – Clock and/or 5V Command Configuration

- Check that the Clock / No Clock and 5V / No 5V commands are defined correctly and enabled.
- If required, configure the other commands, and add them to the CEC command list.

The display is triggered to turn on and off automatically via 5V/No 5V/Clock/No Clock commands.

For further details, see [Configuring CEC Commands](#) on page 50.

Controlling the Display via its RS-232 Port

In case your display does not include the CEC feature you connect the RS-232 port to the display and control the display via the RS-232 port in any of the following ways:

- [Controlling the Display using Ethernet \(Sending to the Display's RS-232 Port\)](#) on page 22.
- [Controlling the Display via FC-18's Front Panel Buttons \(Sending to the Display's RS-232 Port\)](#) on page 23.
- [Controlling the Display via FC-18's REMOTE ON/OFF Pins \(Sending to the Display's RS-232 Port\)](#) on page 24.
- [Controlling the Display via FC-18's REMOTE TOGGLE Pin \(Sending to the Display's RS-232 Port\)](#) on page 26.
- [Controlling the Display Automatically via the RS-232 Port](#) on page 27.

If your display does not include CEC features, you can also send display on/off commands via the Ethernet port (see [Controlling the Display via the Network \(Ethernet\)](#) on page 28).

If your display includes CEC features, you can send display on/off commands via HDMI (see [Controlling the Display via HDMI OUT Port \(CEC\)](#) on page 14).

Controlling the Display using Ethernet (Sending to the Display's RS-232 Port)

You can control the display by tunneling display commands from a control system (using Hercules utility, for example) via Ethernet, and routing these commands through the **FC-18** RS-232 port that is connected to the display.

To control the display via tunneling:

1. Connect a controller to the Ethernet port (8) **FC-18** and connect the RS-232 port (10) and the HDMI port (12) to the RS-232-controlled display.

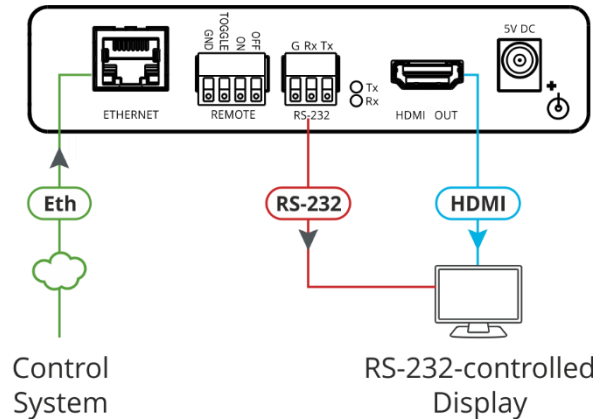

Figure 23: Sending Commands via Ethernet Tunneling



The gray arrows in [Figure 23](#) show the tunneling direction from the control system to the display.

2. In the Navigation pane, click **RS-232 & Remote**. The RS-232 & Remote page appears.
3. Check **Ethernet Tunneling**.

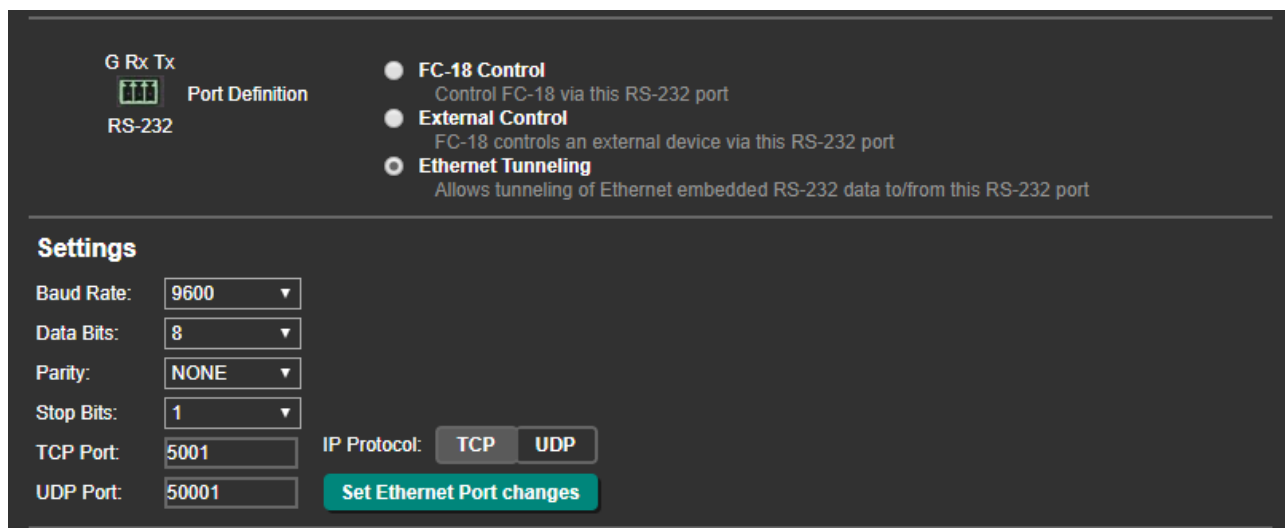

Figure 24: RS-232 & Remote Page – Ethernet Tunneling

4. Under Settings, enter the communication settings of the connected display.
5. Send display commands via Ethernet through the RS-232 port to the display.

The display RS-232 commands are tunneled from the Ethernet to the display via the RS-232 port.

Controlling the Display via FC-18's Front Panel Buttons (Sending to the Display's RS-232 Port)

You can control a display via the FC-18 RS-232 port using the front panel buttons.

To control the display using the ON/OFF buttons via RS-232 port:

1. Connect the RS-232 port (10) and the HDMI port (12) to the RS-232-controlled display.

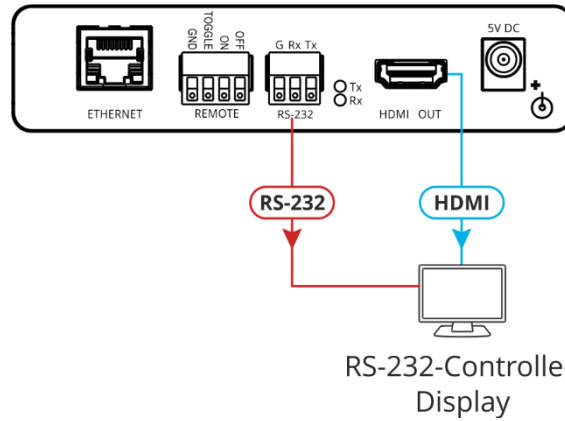

Figure 25: Sending Commands by ON/OFF Buttons via RS-232 Port

2. In the Navigation pane, click **RS-232 & Remote**. The RS-232 & Remote page appears.

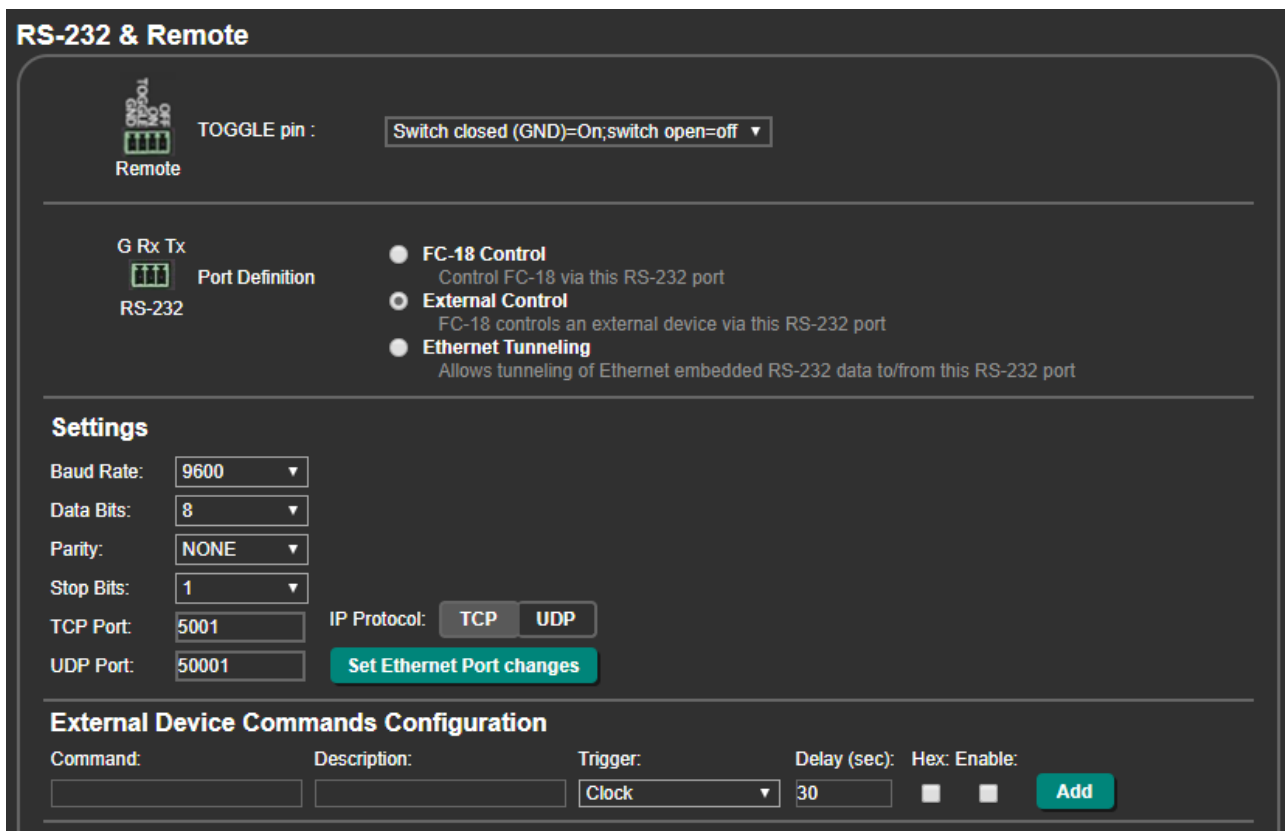

Figure 26: RS-232 & Remote Page – Button On and Button Off Command Configuration

3. Configure the Button On and Button Off display commands (see [Controlling an External Device via RS-232](#) on page 48).

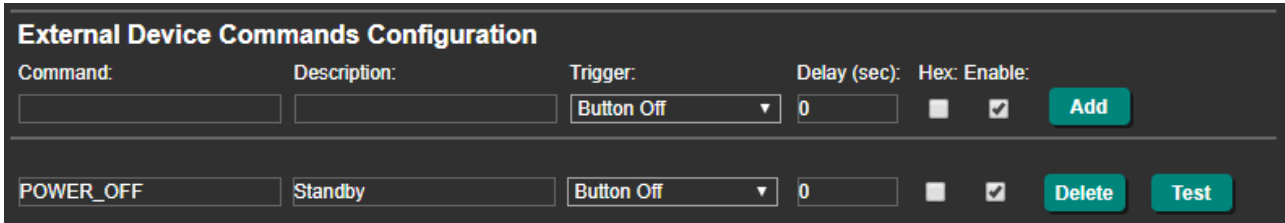

Figure 27: Adding Commands

4. Add and enable the Button On and Button Off commands.
5. Press **ON/OFF** on the front panel to turn the display on or off.

The display is controlled via ON and OFF buttons on the front panel.

Controlling the Display via FC-18's REMOTE ON/OFF Pins (Sending to the Display's RS-232 Port)

You can control the display via the FC-18 RS-232 port using the REMOTE ON/OFF pins or TOGGLE pin.

To control the display using the REMOTE ON/OFF pins via the RS-232 port:

1. Connect the REMOTE ON, OFF and GND pins (or TOGGLE and GND pins) ^⑨ to remote control buttons and the HDMI port ^⑫ to the RS-232-controlled display.

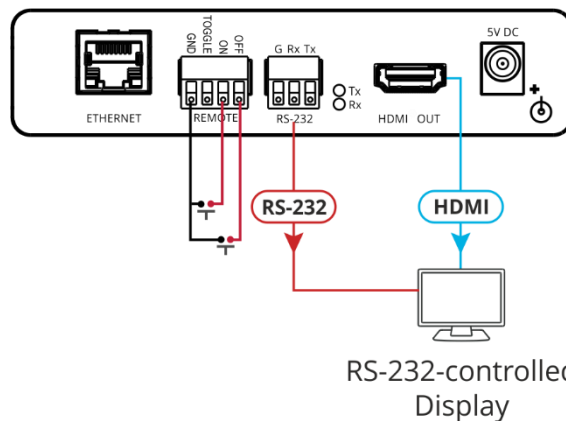

Figure 28: Sending REMOTE ON/OFF Commands via RS-232 Port



If you are using the TOGGLE pin, select the TOGGLE pin function via the RS-232 & Remote page (see [Setting the Toggle Pin Function](#) on page 45).

2. In the Navigation pane, click **RS-232 & Remote**. The RS-232 & Remote page appears (see [Figure 10](#)).

3. Set Port Definition to **External Control**.

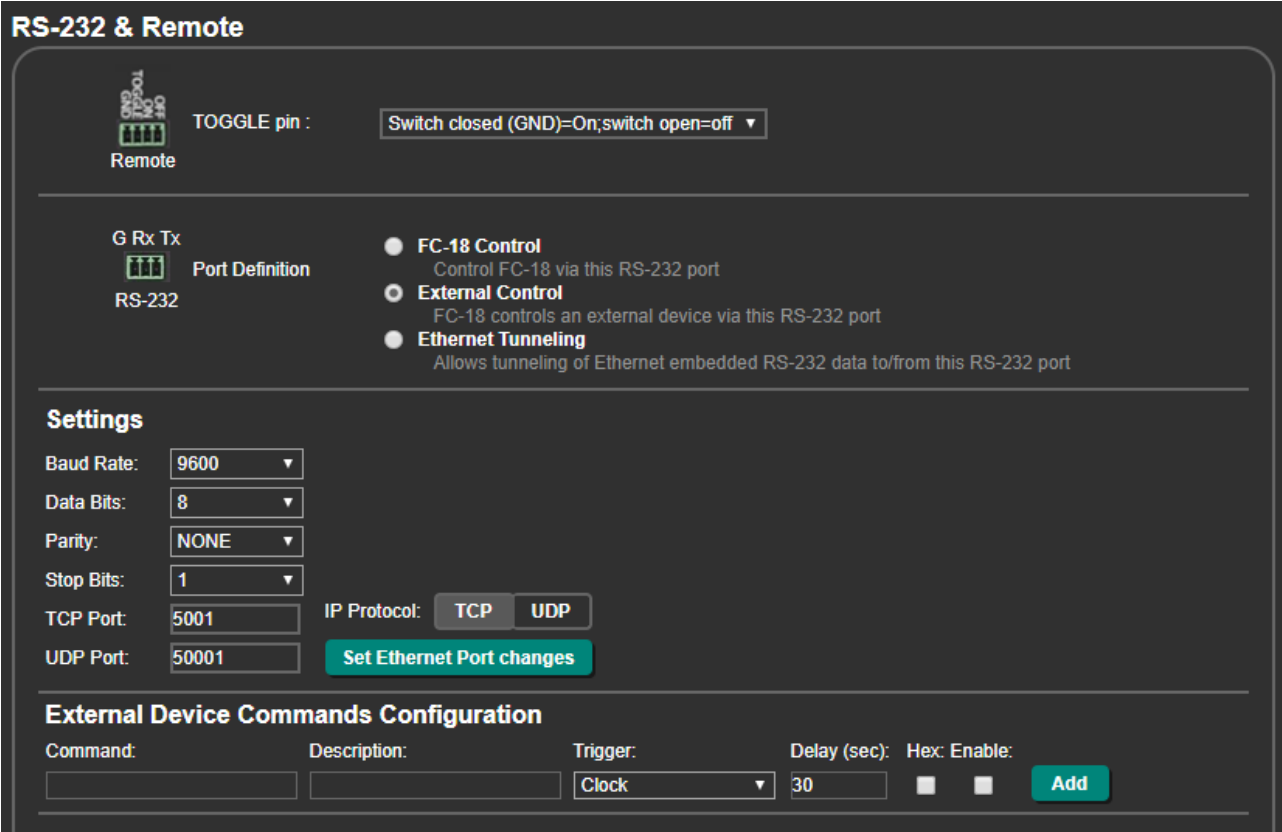

Figure 29: RS-232 & Remote Page – Button On and Button Off Command Configuration

- 4. Configure the Button On and Button Off display commands (see [Controlling an External Device via RS-232](#) on page 48).

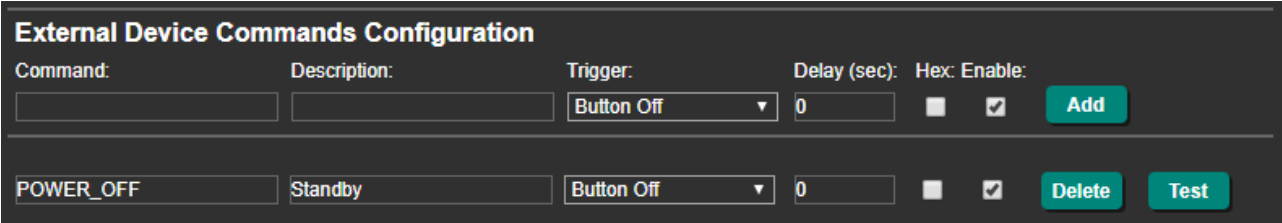

Figure 30: RS-232 & Remote Page – Adding Commands

- 5. Check **Enable** next to the Button On and Button Off commands, and click **Add**.
- 6. Press **ON/OFF** on the front panel to turn the display on or off.

The display is controlled via ON and OFF buttons on the front panel via RS-232.

Controlling the Display via FC-18's REMOTE TOGGLE Pin (Sending to the Display's RS-232 Port)

You can turn the display on or off via the contact closure TOGGLE pin that is connected, for example, to an occupancy sensor.

To control the display using the REMOTE TOGGLE pins via the RS-232 Port:

1. Connect the REMOTE TOGGLE and GND pins (9) to remote control buttons, the RS-232 port (10) to the display and the HDMI port (12) to the RS-232-controlled display.

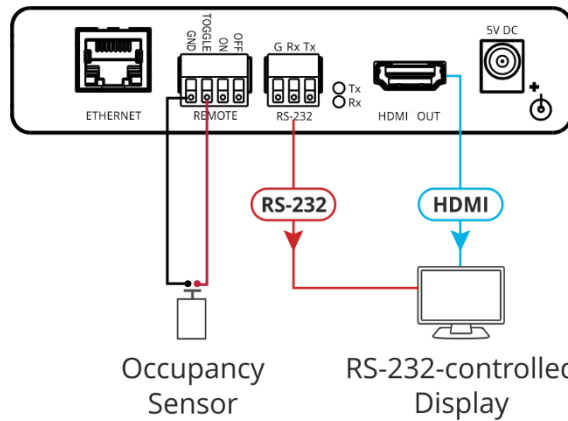

Figure 31: Sending Occupancy-Sensor Triggered Commands via RS-232 Port

2. In the Navigation page, click **RS-232 & Remote**. The RS-232 & Remote page appears.
3. Select the behavior of the TOGGLE pin from the drop-down list. For example, for an occupancy sensor, select a Switch closed/Switch open setting.

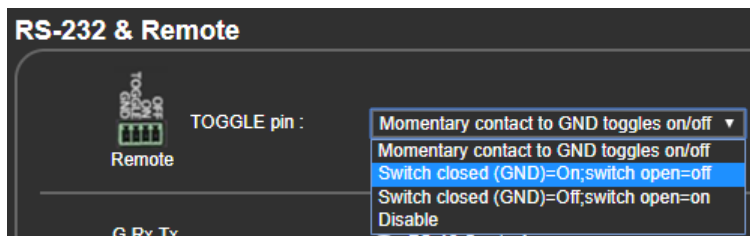

Figure 32: RS-232 & Remote Page – Setting the TOGGLE Pin

4. Set Port Definition to External Control.
5. Configure the Toggle On and Toggle off commands (see [Controlling an External Device via RS-232](#) on page 48).

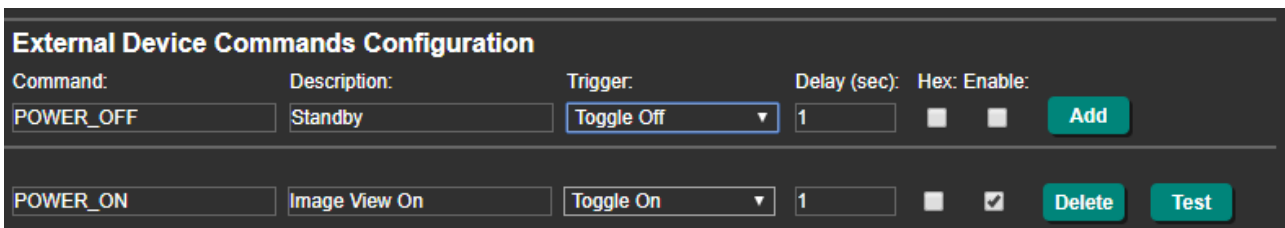

Figure 33: RS-232 & Remote Page – Toggle On and Toggle Off Command Configuration

6. Check **Enable** next to the Button On and Button Off commands, and click **Add**.

The occupancy sensor, connected to the TOGGLE pin, controls the display via the RS-232 port.

Controlling the Display Automatically via the RS-232 Port

You can turn the display on or off automatically when an HDMI signal is present or lost via the presence of 5V and/or clock signal on or off.



The “No Clock” trigger automatically sends a Standby (Off) command when no signal is detected on the output, and “Clock” triggers and an Image View On (On) command when a signal is detected.

To control the display automatically via the RS-232 port:

1. Connect the RS-232 port (10) to the display and the HDMI port (12) to the RS-232-controlled display.

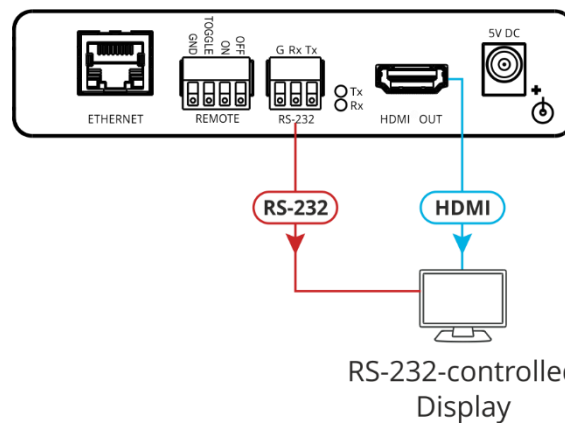

Figure 34: Sending Automatic Commands via RS-232 Port

2. In the Navigation pane, click **Video & Audio**. The Video & Audio page appears.

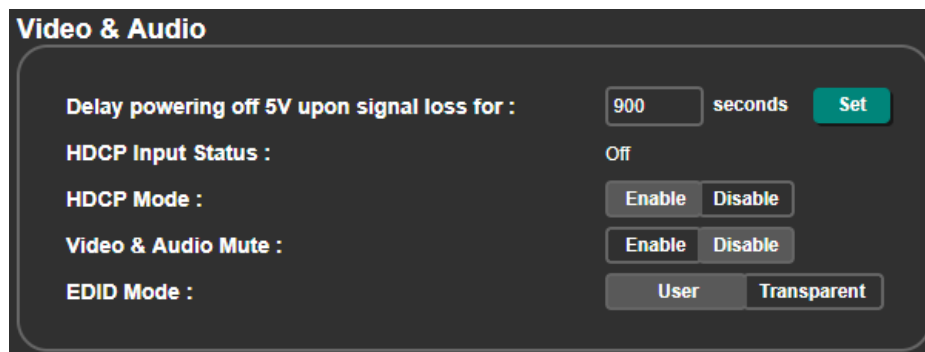

Figure 35: Video & Audio Page – Setting 5V Off Signal-Loss Delay Time

3. Enter the 5V powering off delay time and click **Set**.

- In the Navigation pane, click **RS-232 & Remote**. The RS-232 & Remote page appears.

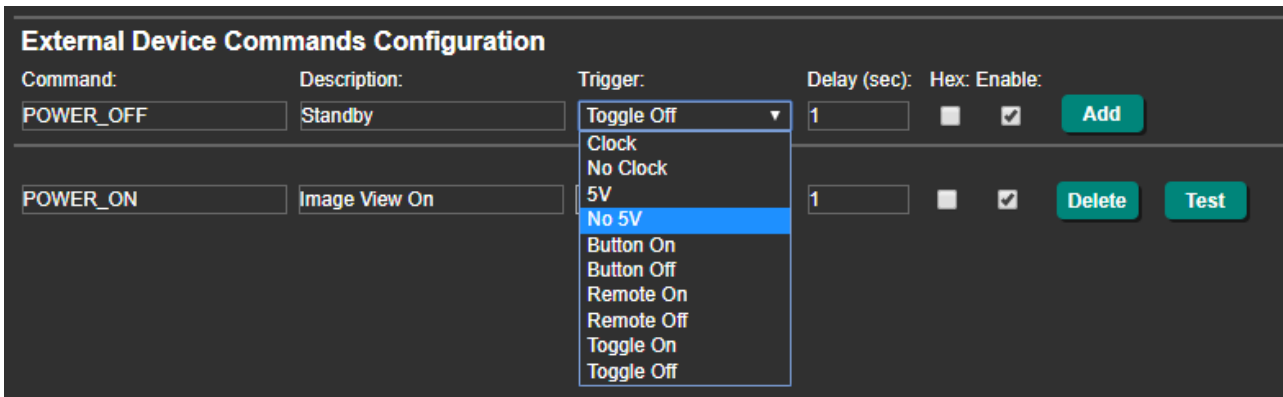

Figure 36: RS-232 & Remote Page – Clock and/or 5V Command Configuration

- Configure the Clock / No Clock and 5V / No 5V commands and add them to the RS-232 command list.
- If required, configure the other commands, and add them to the RS-232 command list.

The display is triggered to turn on and off automatically via 5V/No 5V/Clock/No Clock commands.

Controlling the Display via the Network (Ethernet)

You can connect your network to **FC-18** and to the display's Ethernet port and control the display via Ethernet in any of the following ways:

- [Controlling Via RS-232 \(FC-18 Sends CEC to HDMI OUT\)](#) on page [14](#).
- [Controlling Via Ethernet \(FC-18 Sends CEC to HDMI OUT\)](#) on page [16](#).
- [Controlling Via Front Panel Buttons \(FC-18 Sends CEC to HDMI OUT\)](#) on page [16](#).
- [Controlling Via REMOTE ON/OFF Pins \(FC-18 Sends CEC to HDMI OUT\)](#) on page [17](#).
- [Controlling Via REMOTE TOGGLE Pin \(FC-18 Sends CEC to HDMI OUT\)](#) on page [18](#).
- [Controlling the Display Automatically \(Sending CEC to HDMI OUT\)](#) on page [19](#).

You can also send display on/off commands via the RS-232 port (see [Controlling the Display via its RS-232 Port](#) on page [21](#)).

If your display includes CEC features, you can send display on/off commands via HDMI (see [Controlling the Display via HDMI OUT Port \(CEC\)](#) on page [14](#)).

Controlling the Display from the Network (Sending CEC to the Display)

You can send a CEC command to the display via the network by connecting a laptop or controller to the Ethernet port on FC-18.

To control the display by Ethernet via the Network:

1. Connect a controller to the FC-18 Ethernet port (8) and the HDMI port (12) to the CEC-controlled display.

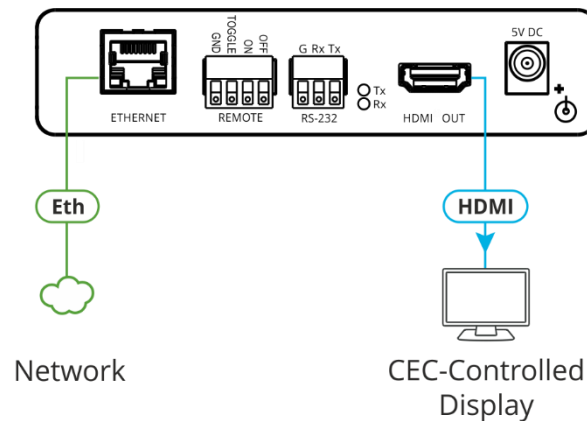

Figure 37: Sending CEC Command via Ethernet Port

2. Send the CEC protocol command to control the display (see [Protocol 3000 Commands](#) on page 63).

The display is controlled by Ethernet via CEC communication to the HDMI port.

Controlling the Display from the Front Panel Buttons (Sending Ethernet to the Display)

You can turn the display on or off using the front panel buttons.

To control the display using the ON/OFF buttons (sending Ethernet to the display):

1. Connect the Ethernet port (8) and the HDMI port (12) to the Ethernet-controlled display.

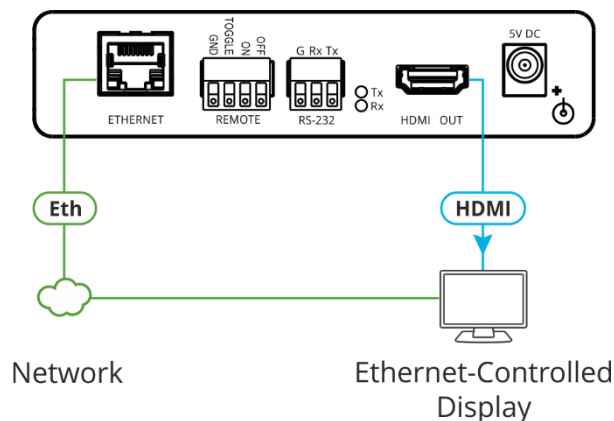

Figure 38: Sending Commands by ON/OFF Buttons via Ethernet Port

2. In the Navigation pane, click **Ethernet**. The Ethernet page appears.

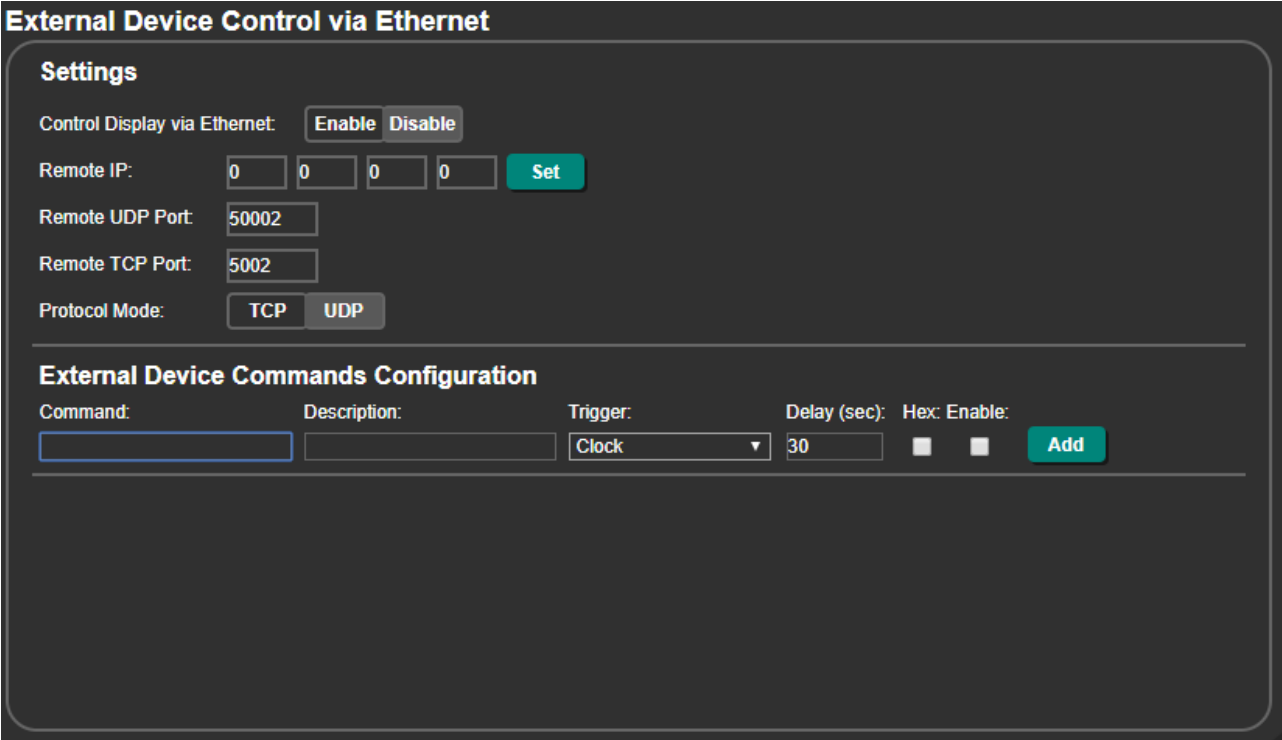

Figure 39: Ethernet Page – Button On and Button Off Command Configuration

- 3. Click **Enable** to control the display via the Ethernet.
- 4. Enter the Remote IP address (the IP address of the display) and click **Set**.
- 5. Set the remote port (UDP – 50002; TCP – 5002, by-default).
- 6. Click **TCP** or **UDP** to select the protocol mode.
- 7. Configure the Button On and Button Off commands, and enable them.

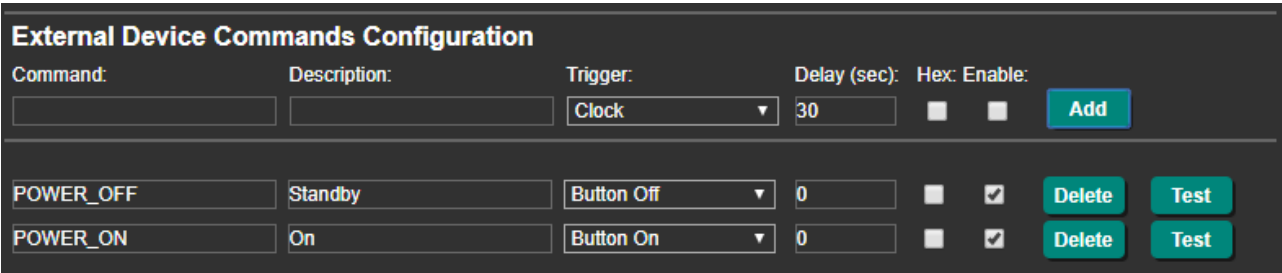

Figure 40: Ethernet Page – Button On and Button Off Commands

8. Press **ON/OFF** on the front panel to turn the display on or off.

The display is controlled via ON and OFF buttons on the front panel.

For further details, see [Controlling an External Device via Ethernet](#) on page 52.

Controlling the Display from REMOTE ON/OFF Pins (Sending Ethernet to the Display)

You can turn the display on or off via the contact closure ON and OFF pins or TOGGLE pin.

To control the display using the REMOTE ON/OFF pins (sending Ethernet to the display):

1. Connect the REMOTE ON, OFF and GND pins (or TOGGLE and GND pins) ⑨ to remote control buttons, and the Ethernet port ⑧ and HDMI port ⑫ to the Ethernet-controlled display.

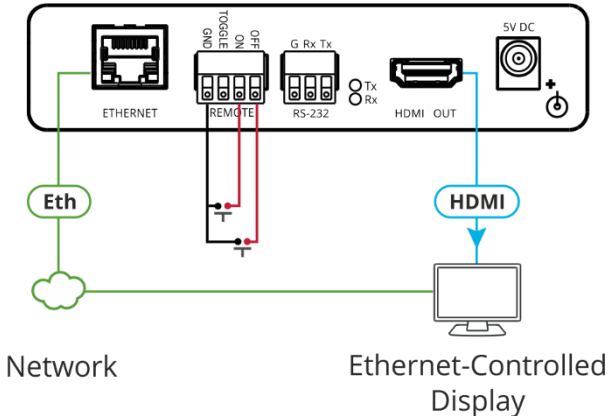



Figure 41: Using Remote On/Off Buttons via Ethernet Port

 If you are using the TOGGLE pin, select the TOGGLE pin function via the RS-232 & Remote page (see [Setting the Toggle Pin Function](#) on page 45).

2. In the Navigation pane, click **Ethernet**. The Ethernet page appears.

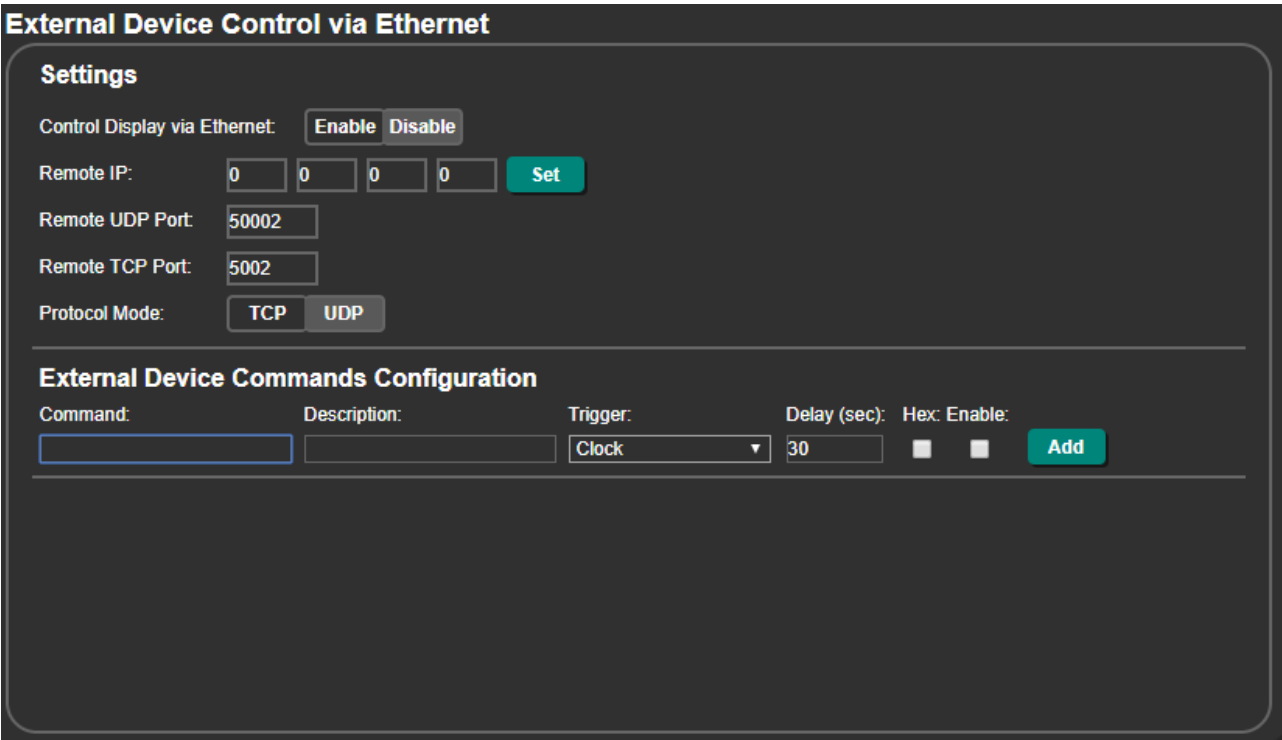

Figure 42: Ethernet Page – Remote On and Remote Off Command Configuration

3. Click **Enable** to control the display via the Ethernet.
4. Enter the Remote IP address and click **Set**.
5. Set the remote port (UDP – 50002; TCP – 5002, by-default).
6. Click **TCP** or **UDP** to select the protocol mode.
7. Configure the Remote On and Remote Off commands.
8. Check **Enable** next to the Button On and Button Off commands, and click **Add**.
9. Momentarily connect an ON or OFF pin to the G pin to turn the display on or off.

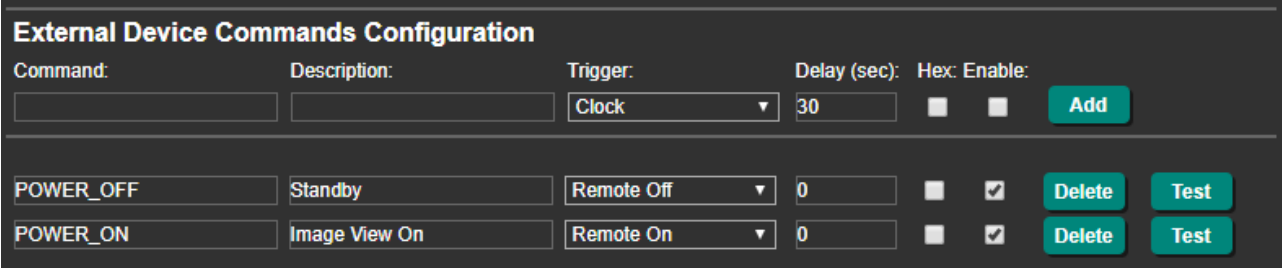

Figure 43: Ethernet Page – Adding Commands

The display is controlled via ON and OFF buttons on the front panel.

For further details, see [Controlling an External Device via Ethernet](#) on page 52.

Controlling the Display from REMOTE TOGGLE Pin (Sending Ethernet to the Display)

You can turn the display on or off via the contact closure TOGGLE pin that is connected, for example, to an occupancy sensor.

To control the display using the REMOTE TOGGLE pins via HDMI:

1. Connect the REMOTE TOGGLE and GND pins (9) to remote control buttons, and the Ethernet port (8) and HDMI port (12) to the Ethernet-controlled display.

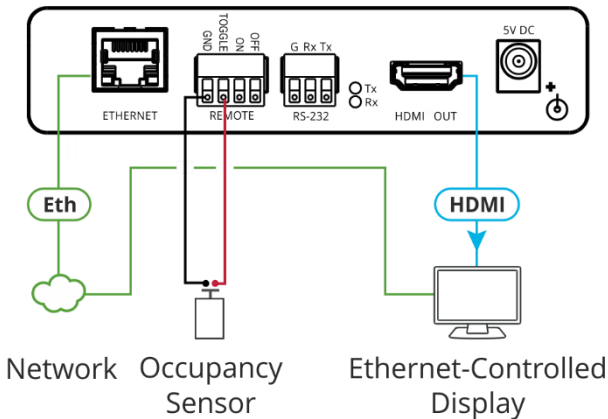

Figure 44: Sending Occupancy-Sensor Triggered Commands via Ethernet Port

2. In the Navigation page, click **RS-232 & Remote**. The RS-232 & Remote page appears.

3. Select the behavior of the TOGGLE pin from the drop-down list.
For example, for an occupancy sensor, select a Switch closed/Switch open setting.

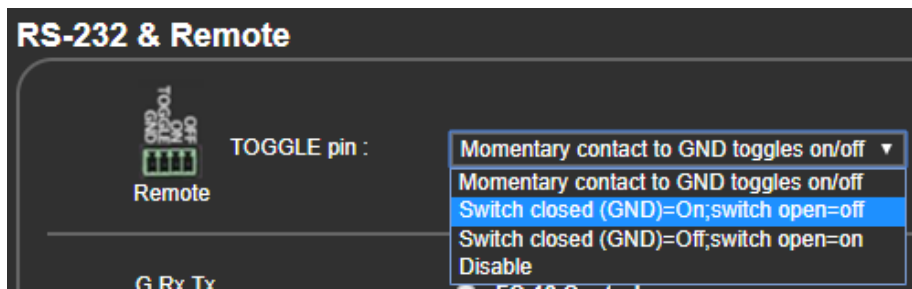

Figure 45: RS-232 & Remote Page – Setting the TOGGLE Pin

4. In the Navigation pane, click **Ethernet**. The Ethernet page appears.

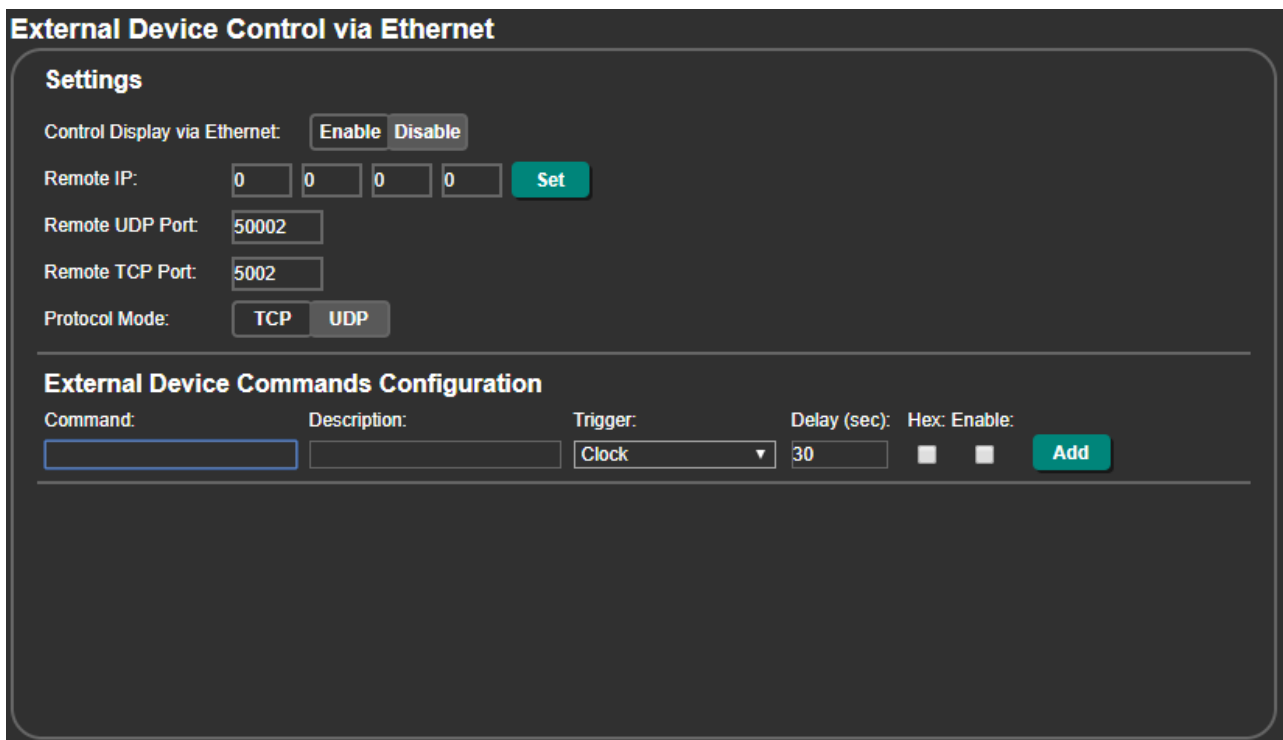

Figure 46: Ethernet Page – Toggle On and Toggle Off Command Configuration

5. Click **Enable** to control the display via the Ethernet.
6. Enter the Remote IP address (the IP address of the display) and click **Set**.
7. Set the remote port (UDP – 50002; TCP – 5002, by-default).
8. Click **TCP** or **UDP** to select the protocol mode.
9. Configure the Toggle On and Toggle Off commands.
10. Check **Enable** next to the Toggle On and Toggle Off commands, and click **Add**.

11. Momentarily connect the TOGGLE pin to the G pin to turn the display on or off.

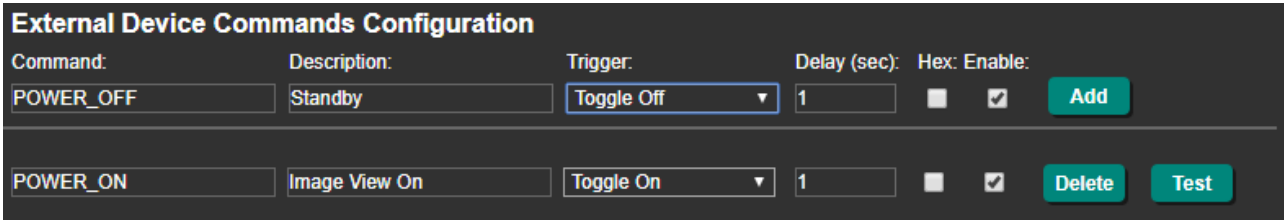

Figure 47: Ethernet Page – Toggle On and Toggle Off Command Configuration

The occupancy sensor, connected to the TOGGLE pin, controls the display via the Ethernet port.

Controlling the Display Automatically via the Ethernet Port

You can turn the display on or off automatically when an HDMI signal is present or lost via the presence of 5V and/or clock signal on or off.



The “No Clock” trigger automatically sends a Standby (Off) command when no signal is detected on the output, and “Clock” triggers and an Image View On (On) command when a signal is detected.

To control the display automatically via the Ethernet port:

1. Connect the Ethernet port (8) and the HDMI port (12) to the Ethernet-controlled display.

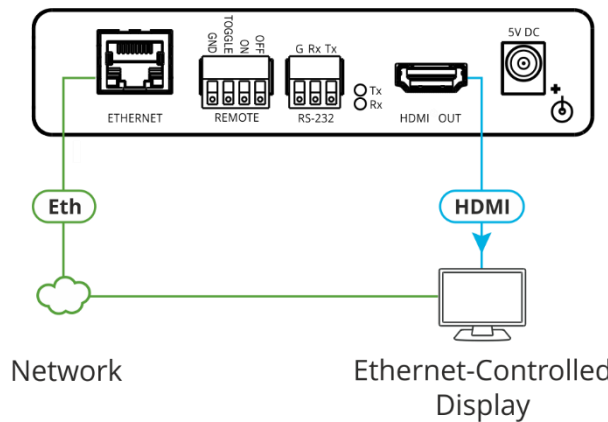

Figure 48: Sending Automatic Commands via Ethernet Port

2. In the Navigation pane, click **Video & Audio**. The Video & Audio page appears.

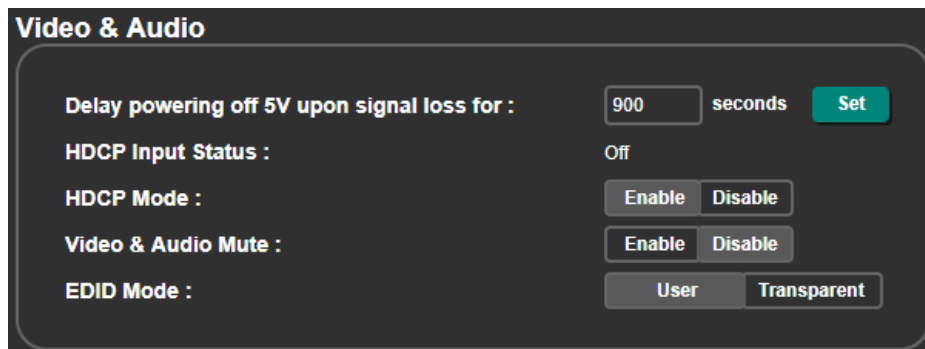

Figure 49: Video & Audio Page – Setting 5V Off Signal-Loss Delay Time

3. Enter the 5V powering off delay time and click **Set**.

4. In the Navigation pane, click **Ethernet**. The Ethernet page appears.

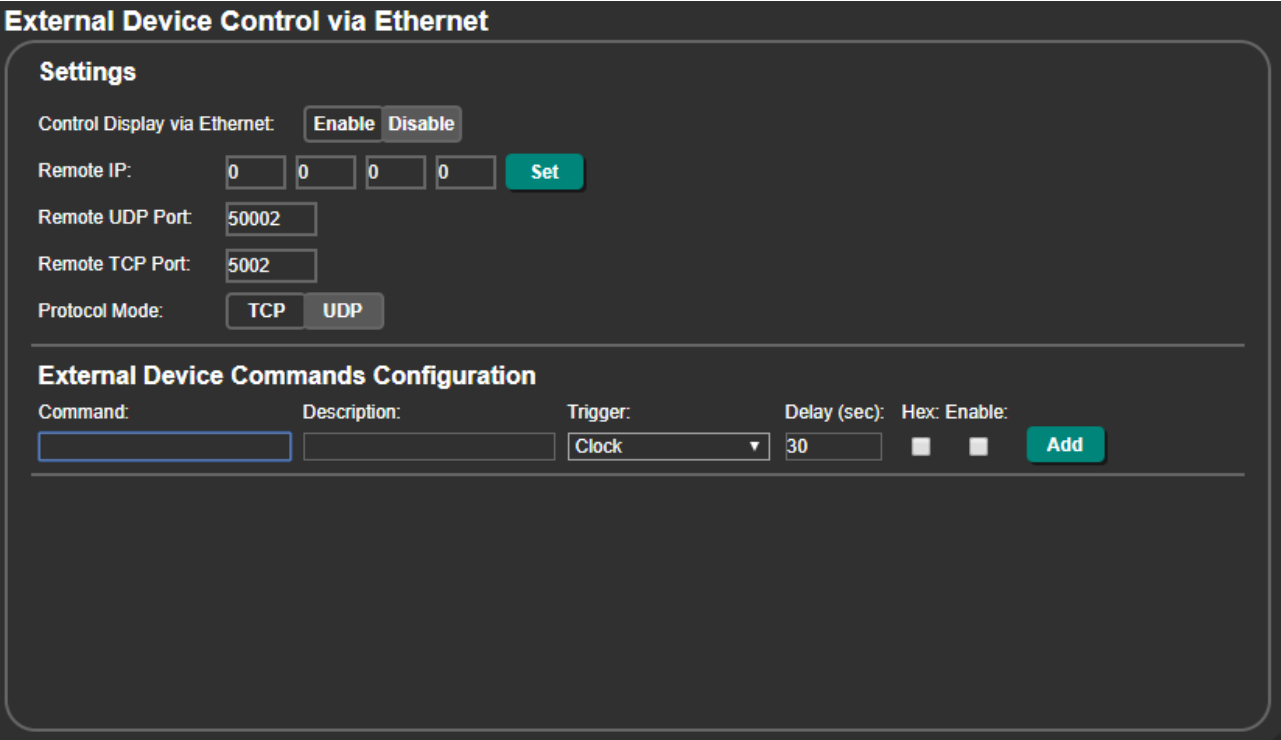

Figure 50: Ethernet Page – Button On and Button Off Command Configuration

- 5. Click **Enable** to control the display via the Ethernet.
- 6. Enter the Remote IP address (of the connected display) and click **Set**.
- 7. Set the remote port (UDP – 50002; TCP – 5002, by-default).
- 8. Click **TCP** or **UDP** to select the protocol mode.
- 9. Configure the Clock / No Clock and 5V / No 5V commands and add them to the Ethernet command list.

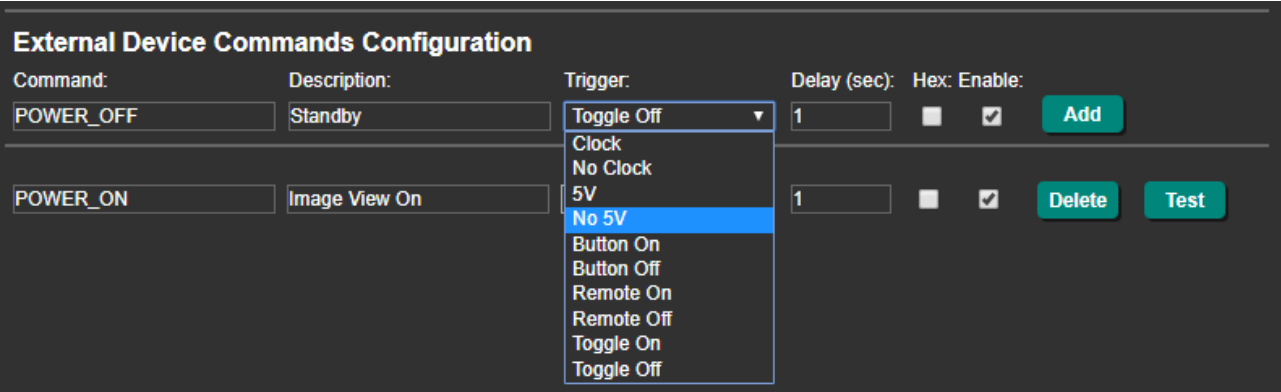

Figure 51: RS-232 & Remote Page – Clock and/or 5V Command Configuration

10. If required, configure the other commands, and add them to the Ethernet command list. The display is triggered to turn on and off automatically via 5V/No 5V/Clock/No Clock commands via the Ethernet port.

For further details, see [Controlling an External Device via Ethernet](#) on page 52.

Using the Embedded Web Pages

Use the embedded web pages to configure and control **FC-18**. The web pages are accessed using a Web browser and an Ethernet connection.

Before attempting to connect:

- Perform the procedures in (see [Connecting to FC-18](#) via Ethernet on page 9).
- Ensure that your browser is supported.

The following operating systems and Web browsers are supported:

Operating Systems	Versions
Windows 7	IE
	Firefox
	Chrome
	Safari
Windows 10	IE
	Edge
	Firefox
	Chrome
Mac	Safari
iOS	Safari



Some features might not be supported by some mobile operating systems.

To browse the Web pages:

1. Open your browser and enter the IP address of the device in the address bar of your browser.



If the page is not secured, it appears when entering the device name or IP address.

2. If the page is secured, once you enter the device name/IP address, the Authentication window appears:

The image shows a dark-themed authentication window. It has two input fields: 'Username:' and 'Password:'. To the right of the 'Password:' field is a blue circular button with a white right-pointing arrow.

Figure 52: Using the Embedded Web Pages – Authentication Window

3. Enter the Username and Password (admin, admin by-default) and click the arrow button. The General Info page appears:

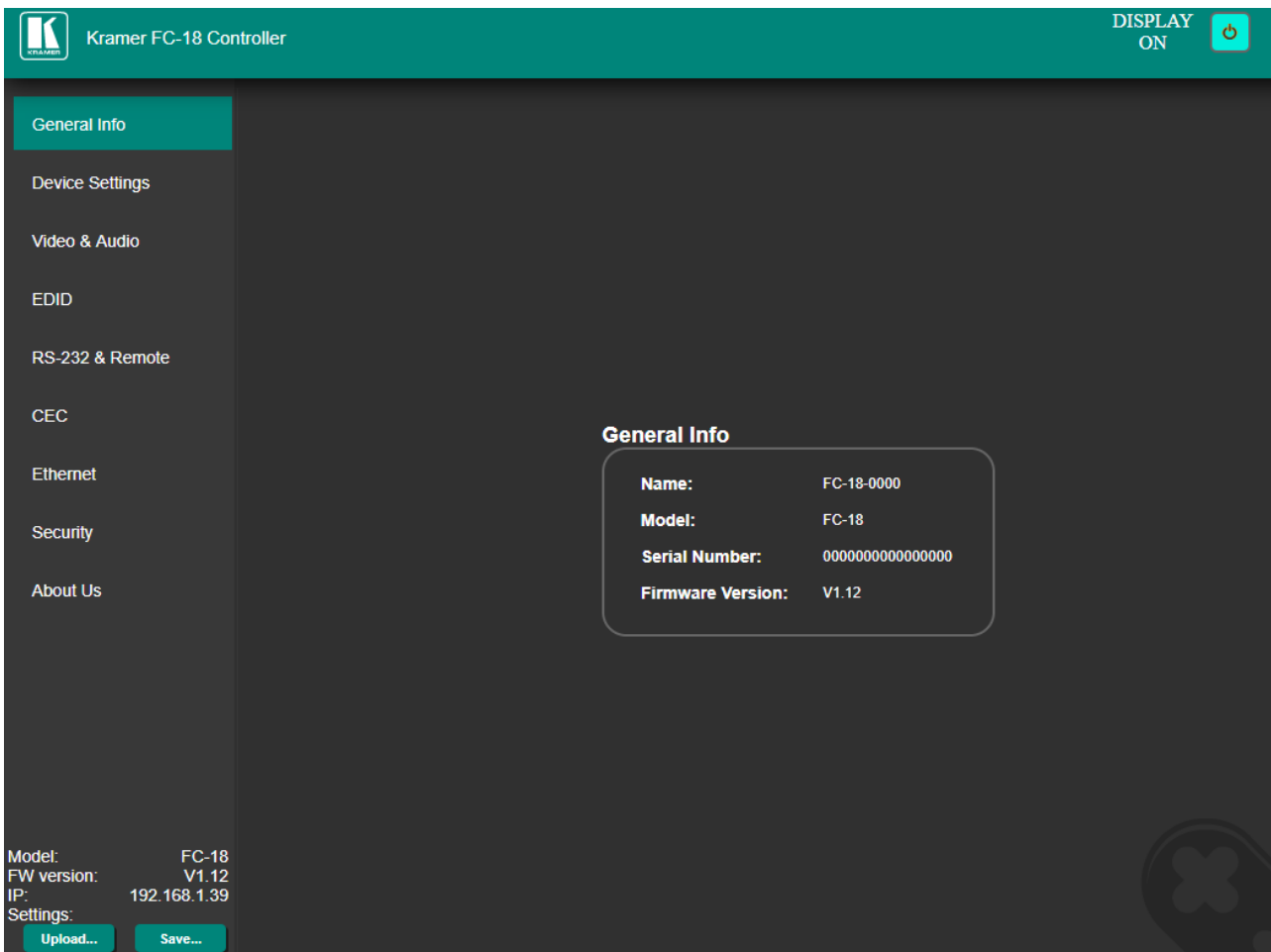

Figure 53: FC-18 Webpage

4. Click the desired page in the Navigation pane.



The model name, FW version and IP address appear on the lower left side of the page. The lower part of the screen lets you save the settings and upload a saved setting.

The **FC-18** webpage enables performing the following functions:

- [Viewing General Information](#) on page [38](#).
- [Changing Device Settings](#) on page [38](#).
- [Defining Video and Audio Settings](#) on page [42](#).
- [Managing EDID](#) on page [43](#).
- [Setting RS-232 Port and Toggle Remote Switch Functions](#) on page [45](#).
- [Configuring CEC Commands](#) on page [50](#).
- [Controlling an External Device via Ethernet](#) on page [52](#).
- [Setting Web Page Access Permission](#) on page [54](#).
- [Viewing About Us Page](#) on page [56](#).

Viewing General Information

View the name and model of the **FC-18** as well as its serial number and firmware version via the General Info page.

To view general information:

- In the Navigation pane, click **General Info**. The General Info page opens.



Figure 54: General Info Page

You can view **FC-18** general information.

Changing Device Settings

Use the Device Settings page to perform the following operations:

- [Changing the Network Settings](#) on page [39](#).
- [Upgrading the Firmware](#) on page [40](#).
- [Soft Factory Reset](#) on page [41](#).

Changing the Network Settings

To change the Network settings:

1. In the Navigation pane, click **Device Settings**. The Device Settings page appears:

Figure 55: Device Settings Page

2. Check/uncheck the **DHCP** box **ON** (default) or **OFF**.

When DHCP is checked:

- IP Address shows the device-acquired IP address (from the DHCP server).



Press both **ON** (6) and **OFF** (5) buttons on the front panel to show the current device IP address on the display.

- Static IP Address, Gateway and Subnet are disabled.



Static IP Address is the actual IP address when operating in non-DHCP mode and is also the fallback IP address, auto-acquired after no DHCP server detection. Default is set to 192.168.1.39.

3. Click **Set**.

The confirmation window appears:

Figure 56: Device Settings Page – Changing to DHCP Mode

4. Click **OK**.
5. If DHCP is **OFF**, change any of the static IP parameters (Static IP Address, Netmask and/or Gateway).
6. Click **Set**.



After changing the IP Address, or DHCP to ON, reload the Web page with the new IP address.

Any change in the device settings requires confirmation (static IP setting, for example).

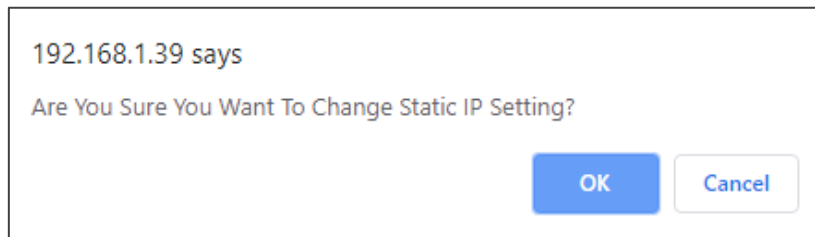

Figure 57: Device Settings Page – Static IP Setting Confirmation

7. Click **OK**.

Network parameters are changed.

Upgrading the Firmware

To upgrade the firmware:

1. In the Navigation pane, click **Device Settings**. The Device Settings page appears (see [Figure 55](#)).
2. Click **Choose File** next to Firmware Update. An Open window appears.
3. Select the correct firmware file.
4. Click **Open**. The selected file appears next to Firmware Update.

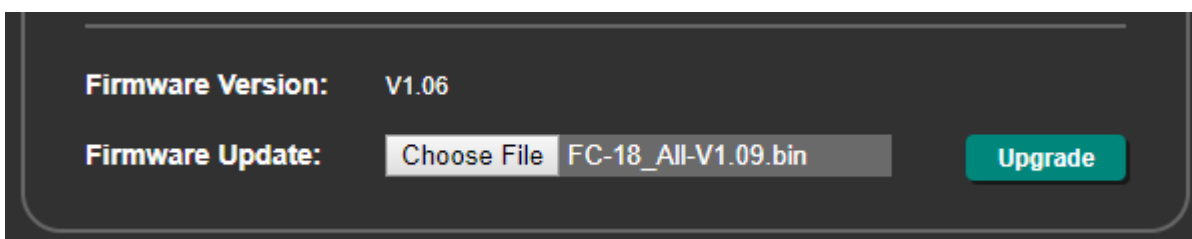

Figure 58: Device Settings Page – Firmware File Uploaded

5. Click **Upgrade**.

The new firmware is uploaded, the firmware is upgraded and the system restarts. Upon completion, the web page refreshes.

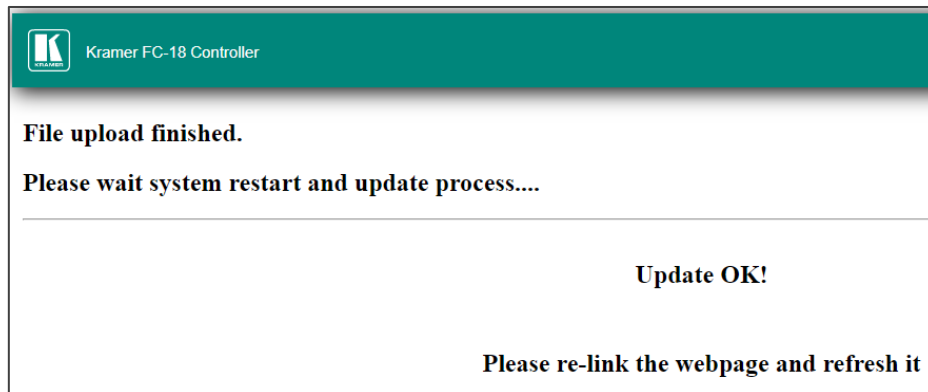

Figure 59: The Device Settings Page – Uploading the New Firmware File

6. Make sure that the new version appears on the Web page lower left side:

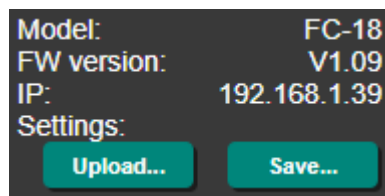

Figure 60: The Device Settings Page – New Firmware Updated

Firmware update is complete.

Soft Factory Reset

FC-18 can be reset to its default settings, excluding Network parameters.

To reset the device to its factory default parameters (except for IP parameters):

1. In the Navigation pane, click **Device Settings**. The Device Settings page appears.
2. Click **Soft Factory reset**. The following message appears:

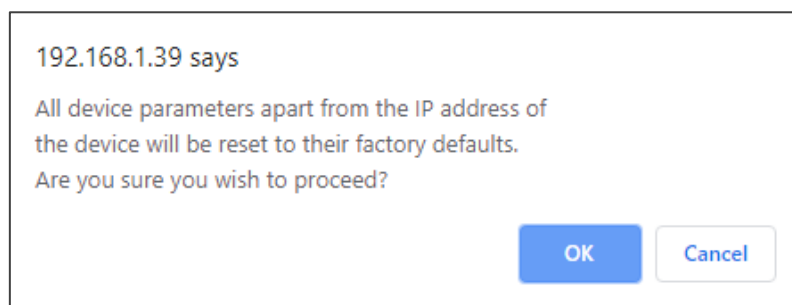

Figure 61: Device Settings Page – Soft Factory Reset Message

3. Click **OK** and wait for the web page to reload following soft factory reset.



See [Default Communication Parameters](#) on page [61](#) to view other factory reset procedures.

Device is reset to its factory default parameters, excluding network parameters.

Defining Video and Audio Settings

Define **FC-18** video and audio settings such as power off delay time upon signal loss, HDCP mode, mute status and EDID mode via the Video & Audio page.

To set video and audio parameters:

1. In the Navigation pane, click **Video & Audio**. The Video & Audio settings page appears.

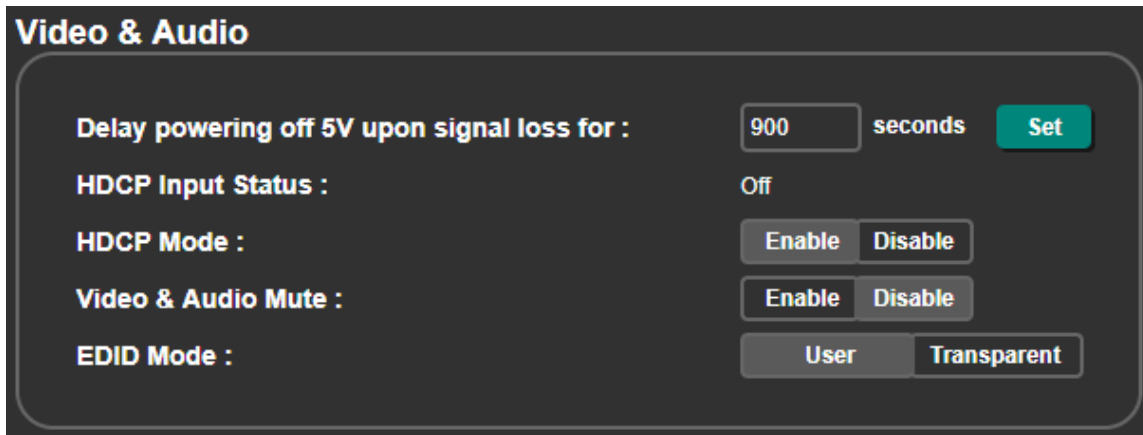

Figure 62: FC-18 Video & Audio Page

2. Set 5V power-off delay time upon signal loss and click **Set**.
3. View the HDCP input status.
Once an input is connected, **FC-18** automatically detects input signal HDCP status.
4. Click **Enable** (default) or **Disable** HDCP Mode for HDCP support on the HDMI input.
5. Click **Enable** or **Disable** (default) video & audio mute.
6. Set EDID mode to:
 - **User** – to use the internal EDID, acquired via the EDID page (see [Managing EDID](#) on page 43).
 - **Transparent** (default) – to use the EDID that is read directly from the display (DDC pass-through).

Managing EDID

Read the EDID from the output, from the default or from a custom file to the **FC-18**.



You can read the EDID only when EDID mode is set to **User** (see [Defining Video and Audio Settings](#) on page 42).

To acquire the EDID from the default EDID:

1. In the Navigation pane, click **EDID**. The EDID management page appears.
2. Make sure that EDID Mode is set to **User**. If it is set to Transparent, a warning message appears.

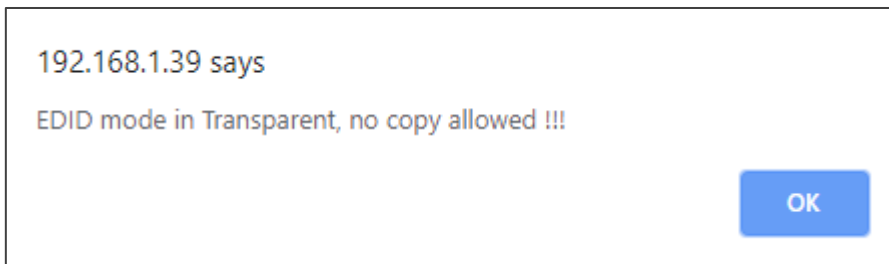

Figure 63: EDID Mode Message

3. Click **Default**.

Figure 64: EDID Management Page

4. Click **Copy** and follow the instructions on-screen. A confirmation message appears.

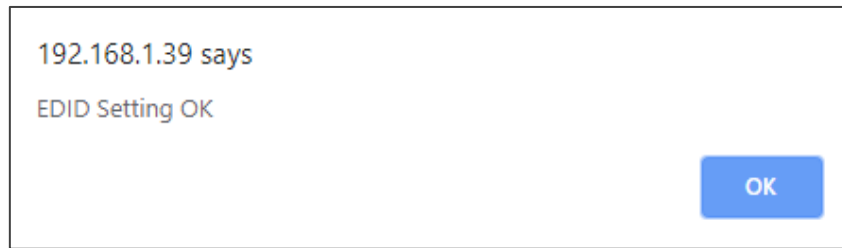

Figure 65: EDID Confirmation Message

5. Click **OK**.

Default EDID is copied.

To copy an EDID from the output to the input:

1. In the Navigation pane, click **EDID**. The EDID management page appears.
2. Make sure that a display is connected to the output.
3. Click HDMI OUT.
4. Click **Copy**. A confirmation message appears.
5. Click **OK**.

The EDID is copied from the output to the input.

To load a custom EDID file:

1. In the Navigation pane, click **EDID**. The EDID management page appears.
2. In the **File** area, click **Choose a file** to browse for the custom EDID file location.
3. Open the custom EDID file.
4. Click **Copy** and follow the instructions on-screen.

The custom EDID is copied to the input.

Setting RS-232 Port and Toggle Remote Switch Functions

Define the function of the RS-232 port and the TOGGLE remote switch on the FC-18, using the RS-232 & Remote page.

Setting the Toggle Pin Function

To set the Toggle pin function:

1. In the Navigation pane, click **RS-232 & Remote**. The RS-232 & Remote page appears.

RS-232 & Remote

Remote

TOGGLE pin :

Port Definition

FC-18 Control
Control FC-18 via this RS-232 port

External Control
FC-18 controls an external device via this RS-232 port

Ethernet Tunneling
Allows tunneling of Ethernet embedded RS-232 data to/from this RS-232 port

Settings

Baud Rate:

Data Bits:

Parity:

Stop Bits:

TCP Port: IP Protocol:

UDP Port:

External Device Commands Configuration

Command:	Description:	Trigger:	Delay (sec):	Hex:	Enable:
<input type="text"/>	<input type="text"/>	<input type="text" value="Clock"/>	<input type="text" value="30"/>	<input type="checkbox"/>	<input type="checkbox"/>

Figure 66: RS-232 & Remote Page

2. Open the TOGGLE pin drop-down box.

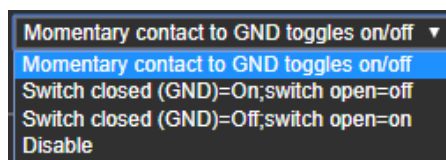

Figure 67: TOGGLE Pin Options

3. Select one of the following:
 - **Momentary Contact to GND toggles on/off** – momentary contact changes the on/off status of the display.
 - **Switch Closed (GND)=on; switch open=off** – when connected to GND the display is on and when disconnected, the display is off.
 - **Switch Closed (GND)=off; switch open=on** – when connected to GND the display is off and when disconnected, the display is on.



An occupancy sensor can be connected to the TOGGLE pin and, based on the sensor type, you can select one of the two last options (switch close and switch open options), to have the display shut off once no motion is detected in the room.

Toggle pin function is defined.

Setting RS-232 Function

The FC-18 RS-232 port can function as an “input” to control the device, an “output” to control an external device, or it can be used for go both ways for tunneling RS-232 data via Ethernet tunneling:

- [Controlling FC-18](#) via RS-232 on page [47](#).
- [Controlling an External Device](#) via RS-232 on page [48](#).
- [Tunneling via Ethernet](#) on page [49](#).



For all 3 of these settings, **bi-directional** RS-232 data is supported.

Tx and Rx LEDs ⁽¹¹⁾ on the FC-18 rear panel indicate the status of the RS-232 port.

Selecting RS-232 Function

To select the RS-232 port function:

1. In the Navigation pane, click **RS-232 & Remote**. The RS-232 & Remote page appears (see [Figure 66](#)).
2. Check RS-232 port function from the Port Definition list:
 - **FC-18 Control** – The RS-232 port is connected to an external controller and is configured to control the FC-18. It accepts RS-232 commands to control the unit (for example, instructing it to send a CEC command to send “turn the display on or off), see [Controlling FC-18 via RS-232](#) on page [47](#)).
 - **External Control** – The RS-232 port is connected to the display and is configured for sending RS-232 commands to the display (default), including display on and off, see [Controlling an External Device via RS-232](#) on page [48](#)).
 - **Ethernet Tunneling** – The RS-232 is configured for bi-directional RS-232 data tunneling via Ethernet (default Ethernet tunneling port: 5001/50001), see [Tunneling via Ethernet](#) on page [49](#)).

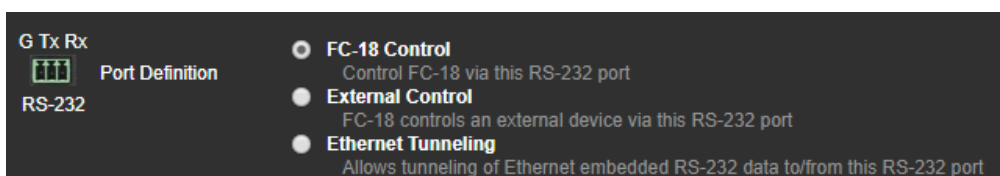

Figure 68: RS-232 & Remote Page – Defining RS-232 Function

Port definition is selected.

Controlling FC-18 via RS-232

Control FC-18 by connecting a laptop or controller to the RS-232 port.

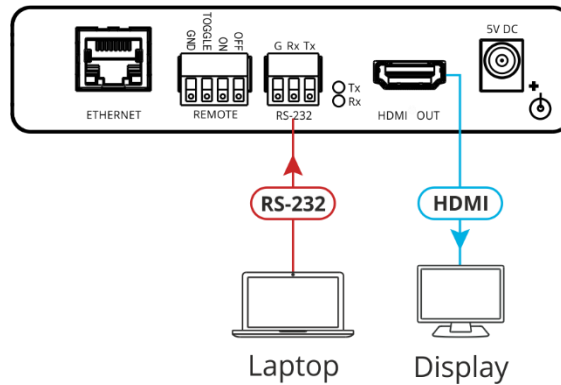

Figure 69: Controlling FC-18 via RS-232 Port

To control the device:

1. Connect a controller to the **FC-18** RS-232 port (10) to control the device.
2. In the Navigation pane, click **RS-232 & Remote**. The RS-232 & Remote page appears.
3. Check Port Definition to **FC-18 Control**.
4. Send protocol commands to control the device.



When sending the **FC-18** CEC command, that command is sent via the HDMI connector to the display.

The device is controlled via RS-232.

Controlling an External Device via RS-232

Connect the RS-232 port to the display to send commands to that external device see [Controlling the Display via its RS-232 Port](#) on page 21).

To send commands to the HDMI acceptor:

1. In the Navigation pane, click **RS-232 & Remote**. The RS-232 & Remote page appears.
2. Set Port Definition to **External Control**:

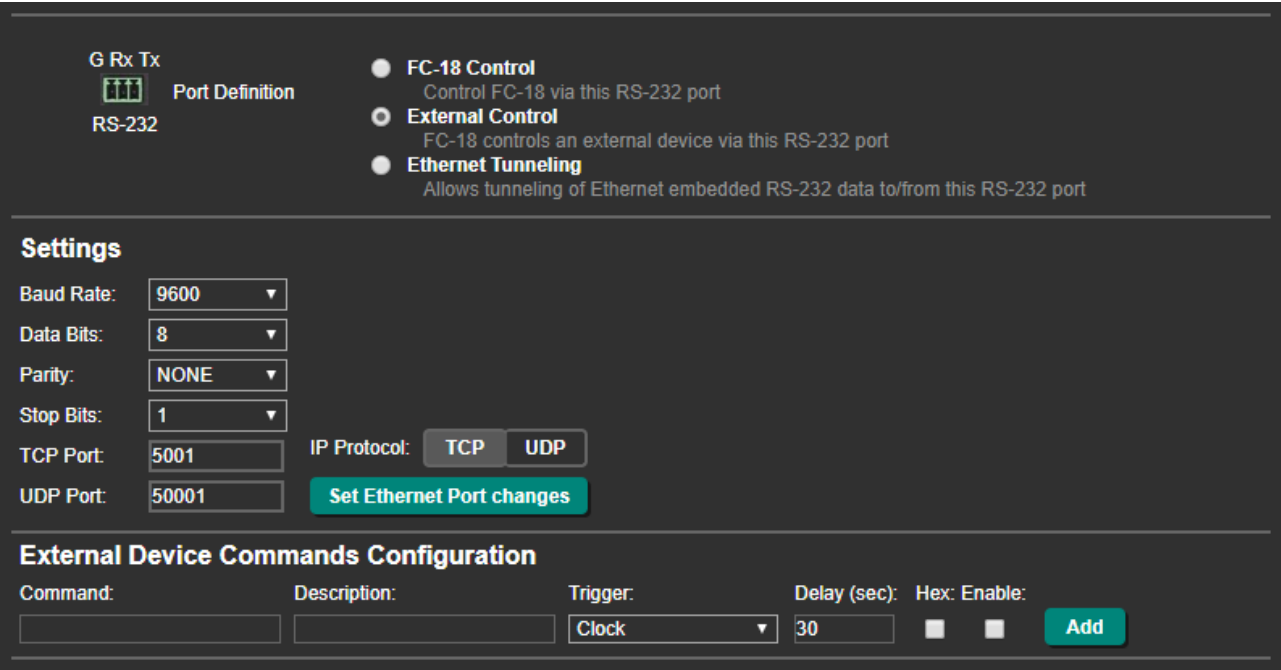

Figure 70: RS-232 & Remote Page – Controlling an External Device

3. Under Settings select the RS-232 port parameters to enable communication with the acceptor.
4. Configure the commands as follows:
 - Enter a device command (for example, turn display on).
 - Enter the command description.
 - Select a trigger from the drop-down box to carry out the command (**Clock**, **No Clock**, **5V**, **No 5V**, **Button On**, **Button Off**, **Remote On**, **Remote Off**, **Toggle On** or **Toggle Off**).
 - Enter a delay time, if required.
 - Check Hex for command Hex format, if required.
 - Check **Enable** to enable the command.

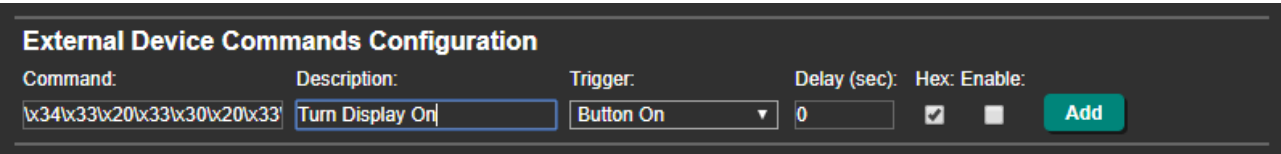

Figure 71: RS-232 – Creating a Command

5. Click **Add**.

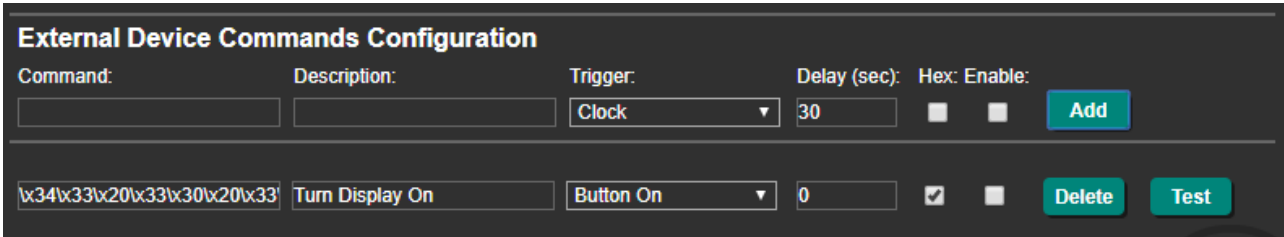

Figure 72: RS-232 Page – Command Added

6. You can:

- Click **Delete** to delete the command.
- Click **Test** to test the command.
- Change any of the command configurations.
- Enable or disable the command.

Control the display via the RS-232 port.

Tunneling via Ethernet

When selecting Ethernet tunneling, you can send commands via Ethernet, allowing embedded RS-232 data to be tunneled between the Ethernet port and the RS-232 port (see [Controlling the Display using Ethernet \(Sending to the Display’s RS-232 Port\)](#) on page 22).

To send commands to the RS-232 connector via Ethernet tunneling:

1. In the Navigation pane, click **RS-232 & Remote**. The RS-232 & Remote page appears.
2. Check **Ethernet Tunneling**.

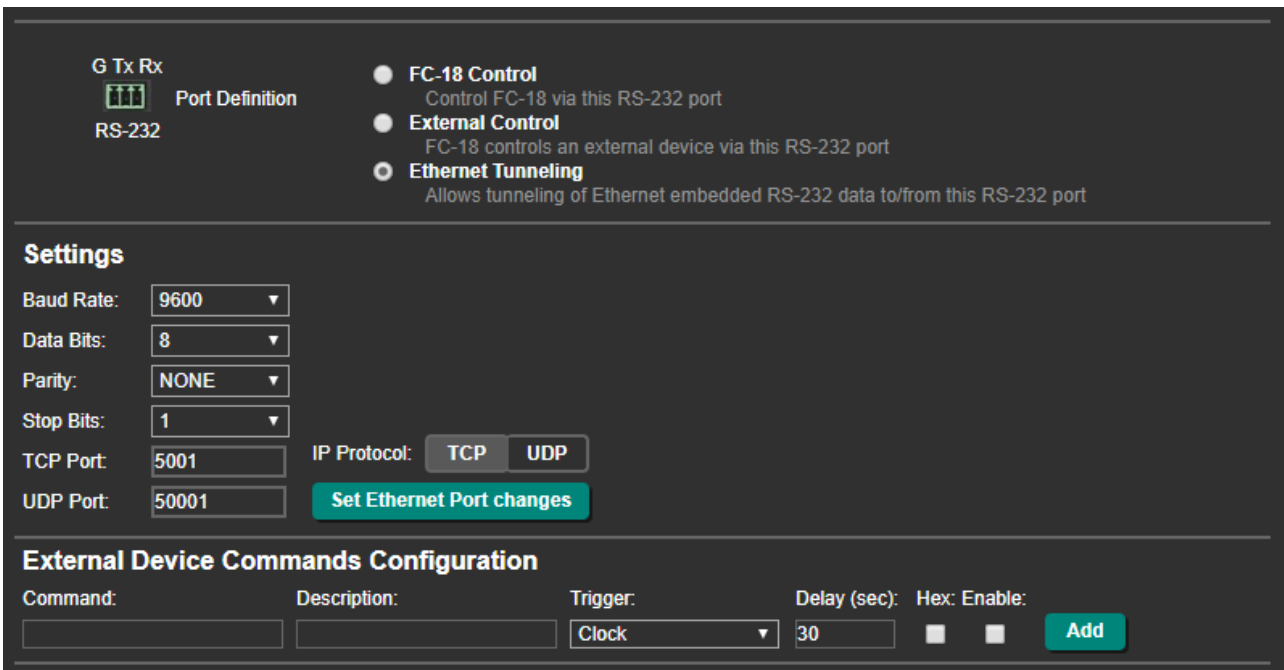

Figure 73: RS-232 Page – Tunneling via Ethernet



3. Enter the display communication settings (to enable communication with the display).

4. Set the remote port (by-default: TCP – 5001; UDP – 50001).
5. Select the IP Protocol mode (TCP or UDP).
6. Click **Set Ethernet Port changes**.
7. Send a display protocol command from a control system that is connected to the Ethernet via the RS-232 port to the display.

Commands are sent to the display via RS-232 tunneling.

Configuring CEC Commands

FC-18 can send a CEC code upon detection of a defined trigger (e.g., on the HDMI input, from an occupancy sensor, etc.), and turn the display on or off accordingly, using the settings on the CEC Configuration page.

-  By default, all types of display on/off commands are listed and enabled.
-  If your display does not support CEC, you can control the display via RS-232 (see [Controlling the Display via its RS-232 Port](#) on page 21) or the Ethernet (see [Controlling the Display via the Network \(Ethernet\)](#) on page 28).

To send CEC commands to the HDMI acceptor:

1. In the Navigation pane select **CEC**. The CEC Configuration page appears.

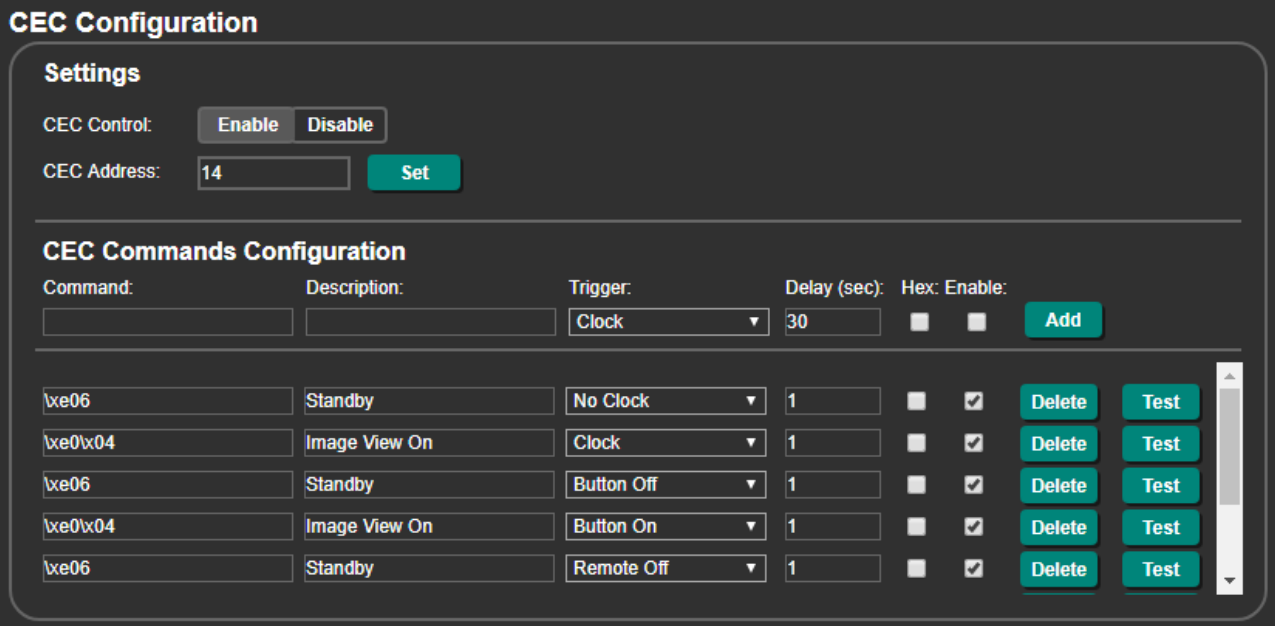

Command	Description	Trigger	Delay (sec)	Hex	Enable	
		Clock	30	<input type="checkbox"/>	<input type="checkbox"/>	Add
\xe06	Standby	No Clock	1	<input type="checkbox"/>	<input checked="" type="checkbox"/>	Delete Test
\xe0x04	Image View On	Clock	1	<input type="checkbox"/>	<input checked="" type="checkbox"/>	Delete Test
\xe06	Standby	Button Off	1	<input type="checkbox"/>	<input checked="" type="checkbox"/>	Delete Test
\xe0x04	Image View On	Button On	1	<input type="checkbox"/>	<input checked="" type="checkbox"/>	Delete Test
\xe06	Standby	Remote Off	1	<input type="checkbox"/>	<input checked="" type="checkbox"/>	Delete Test

Figure 74: CEC Configuration Page

2. **Enable** (default) or **Disable** CEC control.
3. Enter the CEC logical address (14, by default) and click **Set**.

4. Configure a command as follows:

- Enter a device command (for example, mute).
- Enter the command description.
- Select a trigger from the drop-down box to carry out the command (**Clock**, **No Clock**, **5V**, **No 5V**, **Button On**, **Button Off**, **Remote On**, **Remote Off**, **Toggle On** or **Toggle Off**).
- Enter a delay time, if required.
- Check Hex for command Hex format, if required.
- Check **Enable** to enable the command.

The screenshot shows the 'CEC Commands Configuration' form. It has several input fields: 'Command:' with the value 'x6Bx65x20x30x31x20x30', 'Description:' with 'Mute display', 'Trigger:' with a dropdown menu set to 'No 5V', 'Delay (sec):' with '30', 'Hex:' with an unchecked checkbox, and 'Enable:' with a checked checkbox. An 'Add' button is visible on the right.

Figure 75: RS-232 – Creating a Command

5. Click **Add**.

The screenshot shows the 'CEC Commands Configuration' page with a list of commands. The 'Add' button is highlighted. The list of commands is as follows:

Command	Description	Trigger	Delay (sec)	Hex	Enable	Actions
		Clock	30	<input type="checkbox"/>	<input type="checkbox"/>	Add
x6Bx65x20x30x31x20x30	Mute display	No 5V	30	<input type="checkbox"/>	<input checked="" type="checkbox"/>	Delete Test
x606	Standby	Remote Off	1	<input type="checkbox"/>	<input checked="" type="checkbox"/>	Delete Test
x60x04	Image View On	Remote On	1	<input type="checkbox"/>	<input checked="" type="checkbox"/>	Delete Test
x606	Standby	Toggle Off	1	<input type="checkbox"/>	<input checked="" type="checkbox"/>	Delete Test
x60x04	Image View On	Toggle On	1	<input type="checkbox"/>	<input checked="" type="checkbox"/>	Delete Test
x6Be 01 01x0d	Mute display	No 5V	30	<input type="checkbox"/>	<input checked="" type="checkbox"/>	Delete Test

Figure 76: RS-232 Page – Command Added

6. You can:

- Click **Delete** to delete the command.
- Click **Test** to test the command.
- Change any of the command configurations.
- Enable or disable the command.



The display ON/OFF commands are listed by default.

CEC commands are sent to the display via the HDMI port.

Controlling an External Device via Ethernet

Use the Ethernet to send commands to an Ethernet-controlled display (see [Controlling the Display via the Network \(Ethernet\)](#) on page 28).

To control an external device via the Ethernet:

1. In the Navigation pane, click **Ethernet**. The Ethernet page appears.

External Device Control via Ethernet

Settings

Control Display via Ethernet: Enable Disable

Remote IP:

Remote UDP Port:

Remote TCP Port:

Protocol Mode:

External Device Commands Configuration

Command:	Description:	Trigger:	Delay (sec):	Hex:	Enable:	
<input type="text"/>	<input type="text"/>	<input type="text" value="Clock"/>	<input type="text" value="30"/>	<input type="checkbox"/>	<input type="checkbox"/>	<input type="button" value="Add"/>

Figure 77: Ethernet Display Control

2. Click **Enable** display control via Ethernet (Disable, by-default).
3. Enter the remote IP address of the display.
4. Click **Set**.
5. Set the remote port (UDP – 50002; TCP – 5002, by-default).
6. Click **TCP** or **UDP** to select the protocol mode.
7. Configure the external device commands (for example, to turn the display on when the ON front panel button is pressed):
 - Enter the command, command description.
 - Select a trigger from the drop-down box to carry out the command (**Clock**, **No Clock**, **5V**, **No 5V**, **Button On**, **Button Off**, **Remote On**, **Remote Off**, **Toggle On** or **Toggle Off**).
 - Enter a delay time, if required.
 - Check Hex for command Hex format, if required.
 - Check **Enable** to enable the command.

External Device Commands Configuration

Command:	Description:	Trigger:	Delay (sec):	Hex:	Enable:	
<input type="text" value="POWER_ON"/>	<input type="text" value="Display On"/>	<input type="text" value="Button On"/>	<input type="text" value="0"/>	<input type="checkbox"/>	<input checked="" type="checkbox"/>	<input type="button" value="Add"/>

Figure 78: Configuring an External Device Command

8. Click **Add**.

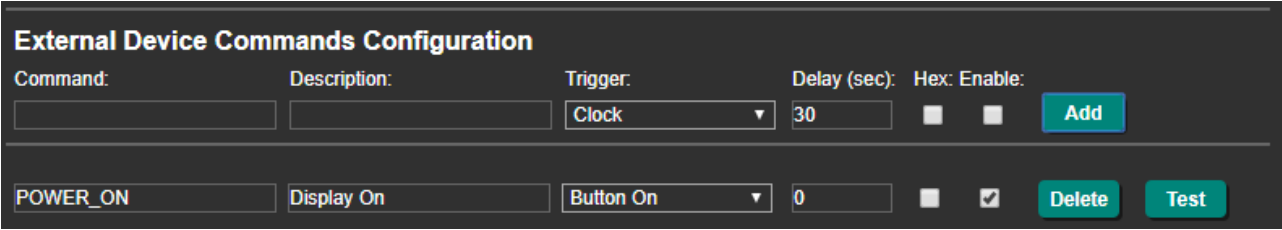

Figure 79: Button On Device Command

9. You can:

- Click **Delete** to delete the command.
- Click **Test** to test the command.
- Change any of the command configurations.
- Enable or disable the command.

10. Repeat the previous steps to add any other commands to the command list:

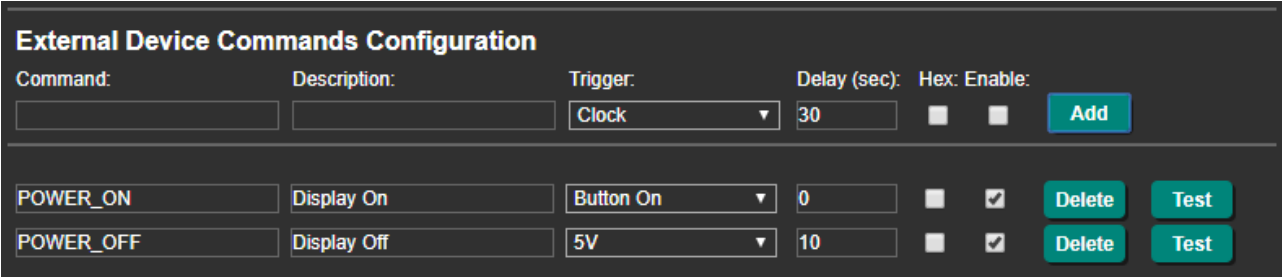

Figure 80: Ethernet Page – Unmute Display Command Added

The enabled command is sent to the display via the Ethernet.

Setting Web Page Access Permission

By default, the Web pages are secured and require access permission (username and password are both: **admin**). This section describes how to change the password and disable/enable access permission.

To change the password:

1. In the Navigation pane, click **Security**. The Security page appears.

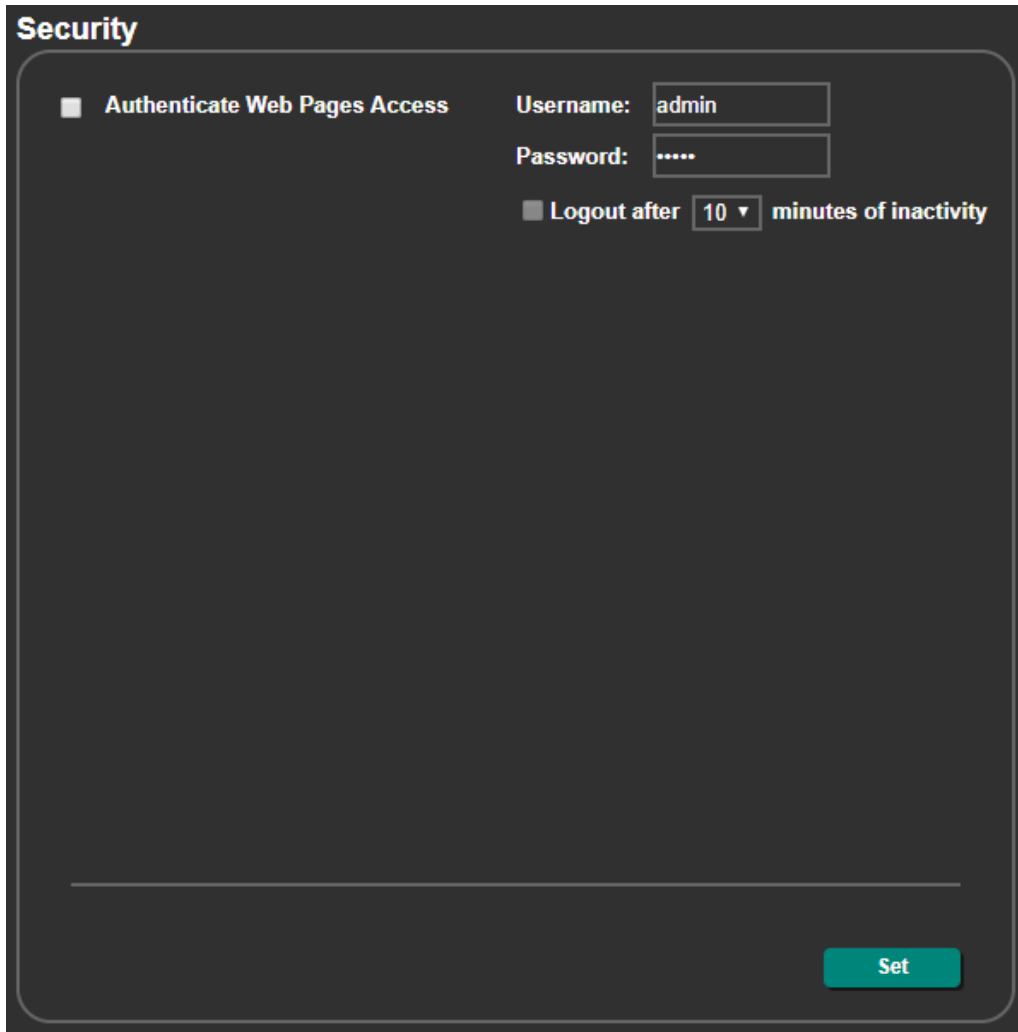

The screenshot shows a dark-themed 'Security' configuration window. At the top left, there is a checkbox labeled 'Authenticate Web Pages Access' which is currently checked. To the right of this checkbox are two input fields: 'Username:' containing the text 'admin' and 'Password:' containing six dots. Below these fields is another checkbox labeled 'Logout after' followed by a dropdown menu showing '10' and the text 'minutes of inactivity'. At the bottom right of the window is a green button labeled 'Set'.

Figure 81: Security Page

2. Enter the new password.

3. Click **Set changes**.

The following message appears:

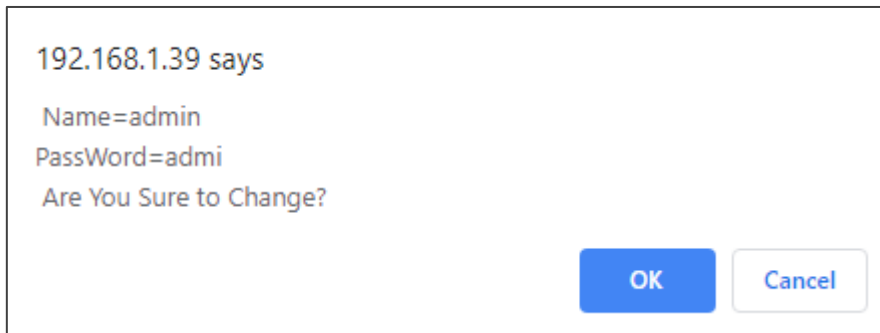

Figure 82: Security Page – Changing the Name/Password

4. Click **OK**.

The following message appears:

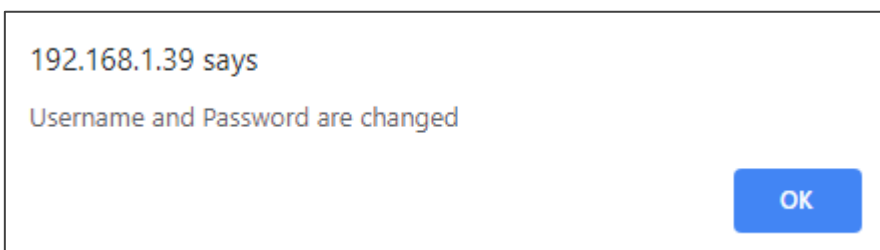

Figure 83: Security – Password Change Confirmation

5. Click **OK**.

Username and password have changed.

To disable security:

1. In the Navigation pane, click **Security**. The Security page appears.
2. Uncheck **Authenticate Web pages Access**.
Current credentials are grayed out.
3. Click **Set changes**
The following message appears:



Figure 84: Security – Security Disable Confirmation

4. Click **OK**.

Authentication is not required.

To enable security:

1. In the Navigation pane, click **Security**. The Security page appears.
2. Check **Authenticate Web pages Access**.
Previous credentials are restored.
3. Click **Set changes**
The following message appears:



Figure 85: Security – Security Enable Confirmation

4. Click **OK**.
 appears, and authentication is now required.

Viewing About Us Page

In the Navigation pane, click **About** to view the **FC-18** webpage version and Kramer Electronics Ltd details.



Figure 86: About Us Page

Firmware Upgrade

You can upgrade the firmware via the embedded web pages (see [Upgrading the Firmware](#) on page 40) or by connecting a memory stick to the PROG USB port ①.

To upgrade the firmware via a memory stick:

1. Save the new firmware file to an empty memory stick.
2. Connect power to **FC-18**.
3. Plug the memory stick into the PROG USB port on the **FC-18** front panel.
4. Press and hold the ON button until it flashes and then release.
The device is in the FW upgrading mode.
During FW upgrade, all LEDs are off.
5. When LED button turns ON, firmware upgrade is complete.
6. Check that the webpage shows the latest FW version.
7. Press and hold OFF button for 3 seconds to factory reset the device.

Technical Specifications

Inputs	HDMI	On a female HDMI connector
Outputs	HDMI	On a female HDMI connector
Ports	Ethernet	On an RJ-45 female connector
	RS-232	On a 3-pin terminal block
	USB	On a female USB type-A connector
Video	Max Bandwidth	18Gbps
	Max Resolution	4K@60Hz (4:4:4)
	Compliance	HDMI and HDCP 1.4/2.2
Controls	Rear Panel	Configurable remote contact closure on/off switches / GPI
	Front Panel	Manual ON and OFF buttons
Indication LEDs	Front Panel	Display on/off, HDMI IN, ON LEDs
	Rear Panel	RS-232 Communication LEDs
Power	Consumption	5V DC, 580mA
	Source	5V DC, 4A
Environmental Conditions	Operating Temperature	0° to +40°C (32° to 104°F)
	Storage Temperature	-40° to +70°C (-40° to 158°F)
	Humidity	10% to 90%, RHL non-condensing
Regulatory Compliance	Safety	CE, FCC, UL
	Environmental	RoHs, WEEE
Enclosure	Size	TOOL
	Type	Aluminum
	Cooling	Convection Ventilation
General	Net Dimensions (W, D, H)	12cm x 7.2cm x 2.4cm (4.7" x 2.8" x 0.9")
	Shipping Dimensions (W, D, H)	15.7cm x 12cm x 8.7cm (6.2" x 4.7" x 3.4")
	Net Weight	0.25kg (0.6lbs) approx..
	Shipping Weight	0.8 kg (1.8lbs) approx.
Accessories	Included	Power adapter and cord
Specifications are subject to change without notice at www.kramerav.com		

Default EDID

Monitor

Model name..... FC-18
 Manufacturer..... KMR
 Plug and Play ID..... KMR031D
 Serial number..... 49
 Manufacture date..... 2016, ISO week 19
 Filter driver..... None

 EDID revision..... 1.3
 Input signal type..... Digital
 Color bit depth..... Undefined
 Display type..... RGB color
 Screen size..... 360 x 290 mm (18.2 in)
 Power management..... Standby, Suspend, Active off/sleep
 Extension blocs..... 1 (CEA-EXT)

 DDC/CI..... n/a

Color characteristics

Default color space..... Non-sRGB
 Display gamma..... 2.40
 Red chromaticity..... Rx 0.611 - Ry 0.329

Green chromaticity..... Gx 0.312 - Gy 0.559
 Blue chromaticity..... Bx 0.148 - By 0.131
 White point (default).... Wx 0.320 - Wy 0.336
 Additional descriptors... None

Timing characteristics

Horizontal scan range.... 27-91kHz
 Vertical scan range..... 23-85Hz
 Video bandwidth..... 170MHz
 CVT standard..... Not supported
 GTF standard..... Not supported
 Additional descriptors... None
 Preferred timing..... Yes
 Native/preferred timing.. 1920x1080p at 60Hz (16:9)
 Modeline..... "1920x1080" 148.500 1920 2008 2052 2200 1080 1084 1089 1125 +hsync +vsync
 Detailed timing #1..... 1280x800p at 60Hz (16:10)
 Modeline..... "1280x800" 83.500 1280 1352 1480 1680 800 803 809 831 -hsync +vsync

Standard timings supported

640 x 480p at 60Hz - IBM VGA
 640 x 480p at 72Hz - VESA
 640 x 480p at 75Hz - VESA
 800 x 600p at 56Hz - VESA
 800 x 600p at 60Hz - VESA
 800 x 600p at 72Hz - VESA
 800 x 600p at 75Hz - VESA
 1024 x 768p at 60Hz - VESA
 1024 x 768p at 70Hz - VESA
 1024 x 768p at 75Hz - VESA
 1280 x 1024p at 75Hz - VESA
 1600 x 1200p at 60Hz - VESA STD
 1280 x 1024p at 60Hz - VESA STD
 1400 x 1050p at 60Hz - VESA STD
 1920 x 1080p at 60Hz - VESA STD
 640 x 480p at 85Hz - VESA STD
 800 x 600p at 85Hz - VESA STD
 1024 x 768p at 85Hz - VESA STD
 1280 x 1024p at 85Hz - VESA STD

EIA/CEA-861 Information

Revision number..... 3
 IT underscan..... Supported
 Basic audio..... Supported
 YCbCr 4:4:4..... Supported
 YCbCr 4:2:2..... Supported
 Native formats..... 3
 Detailed timing #1..... 1440x900p at 60Hz (16:10)
 Modeline..... "1440x900" 106.500 1440 1520 1672 1904 900 903 909 934 -hsync +vsync
 Detailed timing #2..... 1366x768p at 60Hz (16:9)
 Modeline..... "1366x768" 85.500 1366 1436 1579 1792 768 771 774 798 +hsync +vsync
 Detailed timing #3..... 1920x1200p at 60Hz (16:10)
 Modeline..... "1920x1200" 154.000 1920 1968 2000 2080 1200 1203 1209 1235 +hsync -vsync
 Detailed timing #4..... 1600x900p at 60Hz (16:9)
 Modeline..... "1600x900" 108.000 1600 1624 1704 1800 900 901 904 1000 +hsync +vsync
 Detailed timing #5..... 1680x1050p at 60Hz (16:10)
 Modeline..... "1680x1050" 146.250 1680 1784 1960 2240 1050 1053 1059 1089 -hsync +vsync

CE video identifiers (VICs) - timing/formats supported

1920 x 1080p at 60Hz - HDTV (16:9, 1:1) [Native]
 1920 x 1080p at 50Hz - HDTV (16:9, 1:1)
 1280 x 720p at 60Hz - HDTV (16:9, 1:1)
 1280 x 720p at 50Hz - HDTV (16:9, 1:1)
 1920 x 1080i at 60Hz - HDTV (16:9, 1:1)
 1920 x 1080i at 50Hz - HDTV (16:9, 1:1)
 720 x 480p at 60Hz - EDTV (4:3, 8:9)
 720 x 576p at 50Hz - EDTV (4:3, 16:15)
 720 x 480i at 60Hz - Doublescan (4:3, 8:9)
 720 x 576i at 50Hz - Doublescan (4:3, 16:15)
 1920 x 1080p at 30Hz - HDTV (16:9, 1:1)
 1920 x 1080p at 25Hz - HDTV (16:9, 1:1)
 1920 x 1080p at 24Hz - HDTV (16:9, 1:1)
 NB: NTSC refresh rate = (Hz*1000)/1001

CE audio data (formats supported)

LPCM 2-channel, 16/20/24 bit depths at 32/44/48 kHz

CE speaker allocation data

Channel configuration.... 2.0
 Front left/right..... Yes
 Front LFE..... No
 Front center..... No
 Rear left/right..... No

Rear center..... No
Front left/right center.. No
Rear left/right center... No
Rear LFE..... No

CE vendor specific data (VSDB)
IEEE registration number. 0x000C03
CEC physical address..... 1.0.0.0
Maximum TMDS clock..... 165MHz

Report information
Date generated..... 05/03/2020
Software revision..... 2.60.0.972
Data source..... File - NB: improperly installed
Operating system..... 6.2.9200.2

Raw data
00,FF,FF,FF,FF,FF,00,2D,B2,1D,03,31,00,00,00,13,1A,01,03,80,24,1D,8C,EA,9C,20,9C,54,4F,8F,26,
21,52,56,2F,CF,00,A9,40,81,80,90,40,D1,C0,31,59,45,59,61,59,81,99,02,3A,80,18,71,38,2D,40,58,2C,
45,00,10,09,00,00,00,1E,9E,20,00,90,51,20,1F,30,48,80,36,00,10,0A,00,00,00,1C,00,00,00,FC,00,46,
43,2D,31,38,0A,20,20,20,20,20,00,00,00,FD,00,17,55,1B,5B,11,00,0A,20,20,20,20,20,01,C4,
02,03,20,F3,4D,90,1F,04,13,05,14,02,11,06,15,22,21,20,23,09,07,07,83,01,00,00,65,03,0C,00,10,00,
9A,29,A0,D0,51,84,22,30,50,98,36,00,10,0A,00,00,00,1C,66,21,56,AA,51,00,1E,30,46,8F,33,00,10,09,
00,00,00,1E,28,3C,80,A0,70,B0,23,40,30,20,36,00,10,0A,00,00,00,1A,30,2A,40,C8,60,84,64,30,18,50,
13,00,10,09,00,00,00,1E,21,39,90,30,62,1A,27,40,68,B0,36,00,10,0A,00,00,00,1C,00,00,00,00,00,08

Default Communication Parameters

RS-232	
Baud Rate:	115,200
Data Bits:	8
Stop Bits:	1
Parity:	None
Command Format:	ASCII
Example (disable video on the output):	#VMUTE_1,1<CR>
Ethernet	
To reset the IP settings to the factory reset values go to:	
Static IP Address:	192.168.1.39
Subnet mask:	255.255.0.0
Default gateway:	192.168.0.1
TCP Port #:	5000
UDP Port #:	50000
Remote port for Ethernet Display Control	
TCP Port #:	5002
UDP Port #:	50002
Remote port for Ethernet Tunneling	
TCP Port #:	5001
UDP Port #:	50001
Factory Reset	
Embedded web pages	Go to: Device Settings-> Soft factory reset
Full Factory Reset	Press and hold OFF button for 3 seconds.
Protocol 3000	#FACTORY<CR>
Security	
Security User/Password	admin/admin

Protocol 3000

Kramer devices can be operated using Kramer Protocol 3000 commands sent via serial or Ethernet ports.

Understanding Protocol 3000

Protocol 3000 commands are a sequence of ASCII letters, structured according to the following.

- **Command format:**

Prefix X	Command Name	Constant (Space)	Parameter(s)	Suffix
#	Command	_	Parameter	<CR>

- **Feedback format:**



Prefix	Device ID	Constant	Command Name	Parameter(s)	Suffix
~	nn	@	Command	Parameter	<CR><LF>

- **Command parameters** – Multiple parameters must be separated by a comma (,). In addition, multiple parameters can be grouped as a single parameter using brackets ([and]).
- **Command chain separator character** – Multiple commands can be chained in the same string. Each command is delimited by a pipe character (|).
- **Parameters attributes** – Parameters may contain multiple attributes. Attributes are indicated with pointy brackets (<...>) and must be separated by a period (.).

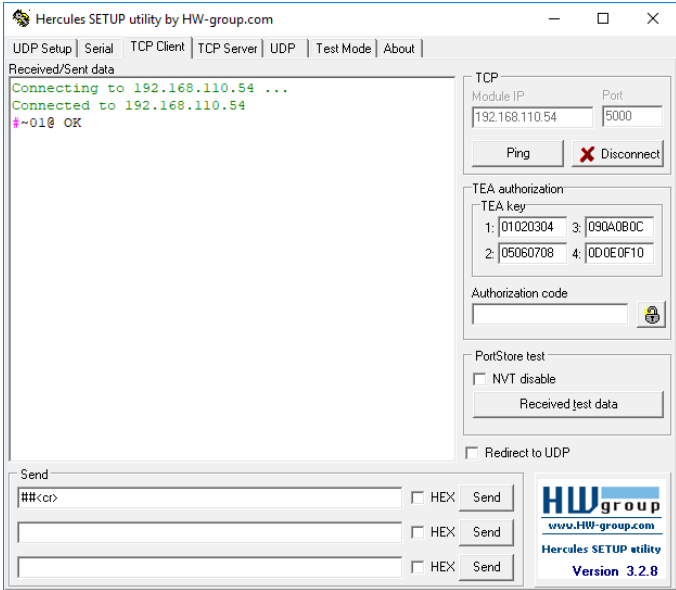
The command framing varies according to how you interface with the FC-18. The following figure displays how the # command is framed using terminal communication software (such as Hercules):









Protocol 3000 Commands

Function	Description	Syntax	Parameters/Attributes	Example
#	Protocol handshaking.  Validates the Protocol 3000 connection and gets the machine number. Step-in master products use this command to identify the availability of a device.	COMMAND #<CR> FEEDBACK ~nn@_OK<CR><LF>		#<CR>
BUILD-DATE?	Get device build date.	COMMAND #BUILD-DATE?_<CR> FEEDBACK ~nn@BUILD-DATE_date,time<CR><LF>	date – Format: YYYY/MM/DD where YYYY = Year MM = Month DD = Day time – Format: hh:mm:ss where hh = hours mm = minutes ss = seconds	Get the device build date: #BUILD-DATE?<CR>
CEC	Set display to ON/OFF	COMMAND #CEC_state<CR> FEEDBACK ~nn@CEC_state<CR><LF>	state – CEC state Off On	Set display to OFF via CEC: #CEC-ON<CR>
CEC-SND	Send CEC command to port.	COMMAND #CEC-SND_port_num,cmd_id,cmd_name,len,cec_command<CR> FEEDBACK ~nn@CEC-SND_port_num,cmd_id,cmd_name,status<CR><LF>	port_num – CEC port transmitting the command: 1 cmd_id – serial number of command for flow control and response commands from device: 0-255 cmd_name – command name len – 1-16 cec_command – CEC format command (in HEX format, no leading zeros, no '0x' prefix) status – 0 – Sent 1 – Gateway disabled 2 – Inactive CEC-Master 3 – Busy 4 – Illegal Message Parameter 5 – Illegal CEC Address Parameter 6 – Illegal CEC Command 7 – Timeout 8 – Error	Send a display ON command: #CEC-SND 1,1,ON,2,E004<CR>
CPEDID	Copy EDID data from the output to the input EEPROM.  Destination bitmap size depends on device properties (for 64 inputs it is a 64-bit word). Example: bitmap 0x0013 means inputs 1,2 and 5 are loaded with the new EDID. In certain products Safe_mode is an optional parameter. See the HELP command for its availability.	COMMAND #CPEDID_src_type,src_id,dst_type,dest_bitmap<CR> or #CPEDID_src_type,src_id,dst_type,dest_bitmap <CR> FEEDBACK ~nn@CPEDID_src_stg,src_id,dst_type,dest_bitmap<CR><LF> ~nn@CPEDID_src_stg,src_id,st_type,dest_bitmap<CR><LF>	src_type – EDID source type (usually output) 0 – Input 1 – Output 2 – Default EDID src_id – Number of chosen source stage 1 – Output dst_type – EDID destination type (usually input) 0 – Input dest_bitmap – Bitmap representing destination IDs. Format: XXXX...X, where X is hex digit. The binary form of every hex digit represents corresponding destinations. 0 – indicates that EDID data is not copied to this destination. 1 – indicates that EDID data is copied to this destination.	Copy the EDID data from the Output 1 (EDID source) to the Input: #CPEDID_1,1,0,0x01<CR> Copy the EDID data from the default EDID source to the Input: #CPEDID_2,0,0,0x01<CR>
DISPLAY?	Get output HPD status.	COMMAND #DISPLAY?_out_id<CR> FEEDBACK ~nn@DISPLAY_out_id,status<CR><LF>	out_id – Output number 1 – Output status – HPD status according to signal validation 0 – Signal or sink is not valid 1 – Signal or sink is valid 2 – Sink and EDID is valid	Get the output HPD status of Output 1: #DISPLAY?_1<CR>
ECHO	Set echo on or off.	COMMAND #ECHO_status <CR> FEEDBACK ~nn@ECHO_status OK<CR><LF>	status – ??? 0 – Echo off 1 – Echo on	Set echo status to on: #ECHO_1<CR>
ECHO?	Get EDID color space.	COMMAND #ECHO?_<CR> FEEDBACK ~nn@ECHO_status<CR><LF>	status – 0 – Echo off 1 – Echo on	Get Echo status: #ECHO?_<CR>
ETH-PORT	Set Ethernet port protocol.	COMMAND #ETH-PORT_portType,ETHPort<CR> FEEDBACK ~nn@ETH-PORT_portType,ETHPort<CR><LF>	portType – TCP/UDP 0 – TCP 1 – UDP ETHPort – TCP/UDP port number	Set the Ethernet port protocol for TCP to port 12457: #ETH-PORT_0,12457<CR>

Function	Description	Syntax	Parameters/Attributes	Example										
ETH-PORT?	Get Ethernet port protocol.	COMMAND #ETH-PORT?_portType<CR> FEEDBACK ~nn@ETH-PORT?_portType,ETHPort<CR><LF>	portType – TCP/UDP 0 – TCP 1 – UDP ETHPort – TCP / UDP port number (0 – 65534)	Get the Ethernet port protocol for UDP: #ETH-PORT?_1<CR>										
FACTORY	Reset device to factory default configuration. i This command deletes all user data from the device. The deletion can take some time. Your device may require powering off and powering on for the changes to take effect.	COMMAND #FACTORY<CR> FEEDBACK ~nn@FACTORY_OK<CR><LF>		Reset the device to factory default configuration: #FACTORY<CR>										
HDCP-MOD	Set HDCP mode. i Set HDCP working mode on the device input: HDCP supported - HDCP_ON [default]. HDCP not supported - HDCP OFF. HDCP support changes following detected sink - MIRROR OUTPUT.	COMMAND #HDCP-MOD_inp_id,mode<CR> FEEDBACK ~nn@HDCP-MOD_inp_id,mode<CR><LF>	inp_id – Input number: 1 – INPUT mode – HDCP mode: 0 – HDCP Off 1 – HDCP On	Set the input HDCP-MODE of IN 1 to Off: #HDCP-MOD_1,0<CR>										
HDCP-MOD?	Get HDCP mode. i Set HDCP working mode on the device input: HDCP supported - HDCP_ON [default]. HDCP not supported - HDCP OFF. HDCP support changes following detected sink - MIRROR OUTPUT.	COMMAND #HDCP-MOD?_inp_id<CR> FEEDBACK ~nn@HDCP-MOD_inp_id,mode<CR><LF>	inp_id – Input number: 1 – INPUT mode – HDCP mode: 0 – HDCP Off 1 – HDCP On	Get the input HDCP-MODE of IN 1: #HDCP-MOD?_1<CR>										
HDCP-STAT?	Get HDCP signal status. i On output – sink status. On input – signal status.	COMMAND #HDCP-STAT?_stage,stage_id<CR> FEEDBACK ~nn@HDCP-STAT_stage,stage_id,status<CR><LF>	stage – Input/Output 0 – Input 1 – Output stage_id – Number of chosen stage (1 to max number of inputs/outputs) status – Signal encryption status - valid values On/Off 0 – HDCP Off 1 – HDCP On 2 – Follow input 3 – Mirror output ("MAC mode")	Get the output HDCP-STATUS of IN 1: #HDCP-STAT?_0,1<CR>										
HELP	Get command list or help for specific command.	COMMAND #HELP<CR> #HELP_command_name<CR> FEEDBACK 1. Multi-line: ~nn@Device_command_command..<CR><LF> To get help for command use: HELP (COMMAND_NAME)<CR><LF> ~nn@HELP_command:<CR><LF> description<CR><LF> USAGE: usage<CR><LF>	command – Name of a specific command	Get the command list: #HELP<CR> To get help for AV-SW-TIMEOUT: HELP_AV-SW-TIMEOUT<CR>										
INFO-IO?	LEGACY COMMAND. Get in/out count.	COMMAND #INFO-IO?_<CR> FEEDBACK ~nn@INFO-IOnn_IN_inputs_count,OUT_outputs_count<CR><LF>	inputs_count – Number of inputs in the unit outputs_count – Number of outputs in the unit	Get inputs count: #INFO-IO?_<CR>										
LOAD	Load file to device.	COMMAND #LOAD_file_name,size<CR> FEEDBACK Data sending negotiation: * Device - ~01@LOAD_file_name,size_ready<CR><LF> * End User (+Device)- Send file in Protocol Packets * Device - ~01@LOAD_file_name,size_ok<CR><LF>	file_name – Name of file to save on device size – Size of file data that is sent Using the Packet Protocol Send a command: LDRV, LOAD, IROUT, LDEDID Receive Ready or ERR### If Ready: a. Send a packet, b. Receive OK on the last packet, c. Receive OK for the command Packet structure: Packet ID (1, 2, 3...) (2 bytes in length) Length (data length + 2 for CRC) – (2 bytes in length) Data (data length -2 bytes) CRC – 2 bytes <table border="1" data-bbox="986 1915 1262 1960"> <tr> <td>01</td> <td>02</td> <td>03</td> <td>04</td> <td>05</td> </tr> <tr> <td>Packet ID</td> <td>Length</td> <td>Data</td> <td>CRC</td> <td></td> </tr> </table> 5. Response: ~nnnn_ok<CR><LF> (Where NNNN is the received packet ID in ASCII hex digits.)	01	02	03	04	05	Packet ID	Length	Data	CRC		Load the file_response.dat file to the device: #LOAD_file_response.dat,5360<CR>
01	02	03	04	05										
Packet ID	Length	Data	CRC											

Function	Description	Syntax	Parameters/Attributes	Example
MODEL?	Get device model. <p>i This command identifies equipment connected to Step-in master products and notifies of identity changes to the connected equipment. The Matrix saves this data in memory to answer REMOTE-INFO requests.</p>	COMMAND #MODEL?_<CR> FEEDBACK ~nn@MODEL_<model_name><CR><LF>	model_name – String of up to 19 printable ASCII chars	Get the device model: #MODEL?_<CR>
NAME	Set machine (DNS) name. <p>i The machine name is not the same as the model name. The machine name is used to identify a specific machine or a network in use (with DNS feature on).</p>	COMMAND #NAME_<machine_name><CR> FEEDBACK ~nn@NAME_<machine_name><CR><LF>	machine_name – String of up to 15 alpha-numeric chars (can include hyphen, not at the beginning or end)	Set the DNS name of the device to room-442: #NAME_<room-442><CR>
NAME?	Get machine (DNS) name. <p>i The machine name is not the same as the model name. The machine name is used to identify a specific machine or a network in use (with DNS feature on).</p>	COMMAND #NAME?_<CR> FEEDBACK ~nn@NAME_<machine_name><CR><LF>	machine_name – String of up to 15 alpha-numeric chars (can include hyphen, not at the beginning or end)	Get the DNS name of the device: #NAME?_<CR>
NAME-RST	Reset machine (DNS) name to factory default. <p>i Factory default of machine (DNS) name is "KRAMER_" + 4 last digits of device serial number.</p>	COMMAND #NAME-RST<CR> FEEDBACK ~nn@NAME-RST_<OK><CR><LF>		Reset the machine name (S/N last digits are 0102): #NAME-RST_<KRAMER_0102><CR>
NET-DHCP	Set DHCP mode. <p>i Only 1 is relevant for the mode value. To disable DHCP, the user must configure a static IP address for the device.</p> <p>Connecting Ethernet to devices with DHCP may take more time in some networks.</p> <p>To connect with a randomly assigned IP by DHCP, specify the device DNS name (if available) using the NAME command. You can also get an assigned IP by direct connection to USB or RS-232 protocol port, if available.</p> <p>For proper settings consult your network administrator.</p>	COMMAND #NET-DHCP_<mode><CR> FEEDBACK ~nn@NET-DHCP_<mode><CR><LF>	mode – 0 – Do not use DHCP. Use the IP set by the factory or using the NET-IP command. 1 – Try to use DHCP. If unavailable, use the IP set by the factory or using the NET-IP command.	Enable DHCP mode, if available: #NET-DHCP_<1><CR>
NET-DHCP?	Get DHCP mode.	COMMAND #NET-DHCP?_<CR> FEEDBACK ~nn@NET-DHCP_<mode><CR><LF>	mode – 0 – Do not use DHCP. Use the IP set by the factory or using the NET-IP command. 1 – Try to use DHCP. If unavailable, use the IP set by the factory or using the NET-IP command.	Get DHCP mode: #NET-DHCP?_<CR>
NET-GATE	Set gateway IP. <p>i A network gateway connects the device via another network and maybe over the Internet. Be careful of security issues. For proper settings consult your network administrator.</p>	COMMAND #NET-GATE_<ip_address><CR> FEEDBACK ~nn@NET-GATE_<ip_address><CR><LF>	ip_address – Format: xxx.xxx.xxx.xxx	Set the gateway IP address to 192.168.0.1: #NET-GATE_<192.168.000.001><CR>
NET-GATE?	Get gateway IP. <p>i A network gateway connects the device via another network and maybe over the Internet. Be aware of security problems.</p>	COMMAND #NET-GATE?_<CR> FEEDBACK ~nn@NET-GATE_<ip_address><CR><LF>	ip_address – Format: xxx.xxx.xxx.xxx	Get the gateway IP address: #NET-GATE?_<CR>
NET-IP	Set IP address. <p>i For proper settings consult your network administrator.</p>	COMMAND #NET-IP_<ip_address><CR> FEEDBACK ~nn@NET-IP_<ip_address><CR><LF>	ip_address – Format: xxx.xxx.xxx.xxx	Set the IP address to 192.168.1.39: #NET-IP_<192.168.001.039><CR>
NET-IP?	Get IP address.	COMMAND #NET-IP?_<CR> FEEDBACK ~nn@NET-IP_<ip_address><CR><LF>	ip_address – Format: xxx.xxx.xxx.xxx	Get the IP address: #NET-IP?_<CR>

Function	Description	Syntax	Parameters/Attributes	Example
NET-MAC?	Get MAC address.  For Backward compatibility, the <code>id</code> parameter can be omitted. In this case, the Network ID, by default, is 0, which is the Ethernet control port.	COMMAND #NET-MAC?_id<CR> FEEDBACK ~nn@NET-MAC_id,mac_address<CR><LF>	<code>id</code> – Network ID—the device network interface (if there are more than one). Counting is 0 based, meaning the control port is '0', additional ports are 1,2,3.... <code>mac_address</code> – Unique MAC address. Format: XX-XX-XX-XX-XX-XX where X is hex digit	#NET-MAC?_id<CR>
NET-MASK	Set subnet mask.  For proper settings consult your network administrator.	COMMAND #NET-MASK_net_mask<CR> FEEDBACK ~nn@NET-MASK_net_mask<CR><LF>	<code>net_mask</code> – Format: xxx.xxx.xxx.xxx	Set the subnet mask to 255.255.0.0: #NET-MASK_255.255.000.000<CR>
NET-MASK?	Get subnet mask.	COMMAND #NET-MASK?_<CR> FEEDBACK ~nn@NET-MASK_net_mask<CR><LF>	<code>net_mask</code> – Format: xxx.xxx.xxx.xxx	Get the subnet mask: #NET-MASK<CR>
PROT-VER?	Get device protocol version.	COMMAND #PROT-VER?_<CR> FEEDBACK ~nn@PROT-VER_3000:version<CR><LF>	<code>version</code> – XX.XX where X is a decimal digit	Get the device protocol version: #PROT-VER?_<CR>
RESET	Reset device.  To avoid locking the port due to a USB bug in Windows, disconnect USB connections immediately after running this command. If the port was locked, disconnect and reconnect the cable to reopen the port.	COMMAND #RESET<CR> FEEDBACK ~nn@RESET_OK<CR><LF>		Reset the device: #RESET<CR>
SIGNAL?	Get input signal status.	COMMAND #SIGNAL?_inp_id<CR> FEEDBACK ~nn@SIGNAL_inp_id,status<CR><LF>	<code>inp_id</code> – Input number 1 – Input 1 <code>status</code> – Signal status according to signal validation: 0 – Off 1 – On	Get the input signal lock status of IN 1: #SIGNAL?_1<CR>
SN?	Get device serial number.	COMMAND #SN?_<CR> FEEDBACK ~nn@SN_serial_number<CR><LF>	<code>serial_number</code> – 14 decimal digits, factory assigned	Get the device serial number: #SN?_<CR>
STANDBY	Set standby mode.	COMMAND #STANDBY_on_off<CR> FEEDBACK ~nn@STANDBY_value<CR><LF>	<code>value</code> – On/Off 0 – Off 1 – On	
STANDBY?	Get standby mode status.	COMMAND #STANDBY?_<CR> FEEDBACK ~nn@STANDBY_value<CR><LF>	<code>value</code> – On/Off 0 – Off 1 – On	
UART	Set com port configuration.  The command is backward compatible, meaning that if the extra parameters do not exist, FW goes to RS-232. Stop_bits 1.5 is only relevant for 5 data_bits.	COMMAND #UART_COM_Num,baud_rate,data_bits,parity,stop_bits,serial_type,485_term<CR> FEEDBACK ~nn@UART_COM_Num,baud_rate,data_bits,parity,stop_bits,serial_type,485_term<CR><LF>	<code>COM_Num</code> – 1 <code>baud_rate</code> – 9600 - 115200 <code>data_bits</code> – 5-8 <code>parity</code> – Parity Type 0 – No 1 – Odd 2 – Even 3 – Mark 4 – Space <code>stop_bits</code> – 1/1.5/2 <code>serial_type</code> – 232/485 0 – 232 1 – 485 <code>485_term</code> – 1/0 (optional - this exists only when <code>serial_type</code> is 485)	Set baud rate to 9600, 8 data bits, parity to none and stop bit to 1: #UART_1,9600,8,node,1<CR>
UART?	Get com port configuration.  The command is backward compatible, meaning that if the extra parameters do not exist, FW goes to RS-232. Stop_bits 1.5 is only relevant for 5 data_bits.	COMMAND #UART?_COM_Num<CR> FEEDBACK ~nn@UART_COM_Num,baud_rate,data_bits,parity,stop_bits,serial_type,485_term<CR><LF>	<code>COM_Num</code> – 1 <code>baud_rate</code> – 9600 - 115200 <code>data_bits</code> – 5-8 <code>parity</code> – Parity Type 0 – No 1 – Odd 2 – Even 3 – Mark 4 – Space <code>stop_bits</code> – 1/1.5/2 <code>serial_type</code> – 232/485 0 – 232 1 – 485 <code>485_term</code> – 1/0 (optional - this exists only when <code>serial_type</code> is 485)	Get Com 1 baud rate: #UART?_1<CR>
VERSION?	Get firmware version number.	COMMAND #VERSION?_<CR> FEEDBACK ~nn@VERSION_firmware_version<CR><LF>	<code>firmware_version</code> – XX.XX.XXXX where the digit groups are: major.minor.build version	Get the device firmware version number: #VERSION?_<CR>
VMUTE	Set enable/disable video on output.  Video mute parameter 2 (blank picture) is not supported.	COMMAND #VMUTE_output_id,flag<CR> FEEDBACK ~nn@VMUTE_output_id,flag<CR><LF>	<code>output_id</code> – 1 <code>flag</code> – Video Mute 0 – Video enabled 1 – Video disabled 2 – Blank picture	Disable the video on the output: #VMUTE_1,1<CR>

Function	Description	Syntax	Parameters/Attributes	Example
VMUTE?	<p>Get video on output status.</p> <p> Video mute parameter 2 (blank picture) is not supported.</p>	<p>COMMAND</p> <p>#VMUTE?_output_id_<CR></p> <p>FEEDBACK</p> <p>~nn@VMUTE_output_id,flag<CR><LF></p>	<p>output_id – 1 to number of system outputs</p> <p>flag – Video Mute</p> <p>0 – Video enabled</p> <p>1 – Video disabled</p> <p>2 – Blank picture</p>	

Result and Error Codes

Syntax

In case of an error, the device responds with an error message. The error message syntax:

- **~NN@ERR XXX<CR><LF>** – when general error, no specific command.
- **~NN@CMD ERR XXX<CR><LF>** – for specific command.
- **NN** – machine number of device, default = 01.
- **XXX** – error code.

Error Codes

Error Name	Error Code	Description
P3K_NO_ERROR	0	No error
ERR_PROTOCOL_SYNTAX	1	Protocol syntax
ERR_COMMAND_NOT_AVAILABLE	2	Command not available
ERR_PARAMETER_OUT_OF_RANGE	3	Parameter out of range
ERR_UNAUTHORIZED_ACCESS	4	Unauthorized access
ERR_INTERNAL_FW_ERROR	5	Internal FW error
ERR_BUSY	6	Protocol busy
ERR_WRONG_CRC	7	Wrong CRC
ERR_TIMEDOUT	8	Timeout
ERR_RESERVED	9	(Reserved)
ERR_FW_NOT_ENOUGH_SPACE	10	Not enough space for data (firmware, FPGA...)
ERR_FS_NOT_ENOUGH_SPACE	11	Not enough space – file system
ERR_FS_FILE_NOT_EXISTS	12	File does not exist
ERR_FS_FILE_CANT_CREATED	13	File can't be created
ERR_FS_FILE_CANT_OPEN	14	File can't open
ERR_FEATURE_NOT_SUPPORTED	15	Feature is not supported
ERR_RESERVED_2	16	(Reserved)
ERR_RESERVED_3	17	(Reserved)
ERR_RESERVED_4	18	(Reserved)
ERR_RESERVED_5	19	(Reserved)
ERR_RESERVED_6	20	(Reserved)
ERR_PACKET_CRC	21	Packet CRC error
ERR_PACKET_MISSED	22	Packet number isn't expected (missing packet)
ERR_PACKET_SIZE	23	Packet size is wrong
ERR_RESERVED_7	24	(Reserved)
ERR_RESERVED_8	25	(Reserved)
ERR_RESERVED_9	26	(Reserved)
ERR_RESERVED_10	27	(Reserved)
ERR_RESERVED_11	28	(Reserved)
ERR_RESERVED_12	29	(Reserved)
ERR_EDID_CORRUPTED	30	EDID corrupted
ERR_NON_LISTED	31	Device specific errors
ERR_SAME_CRC	32	File has the same CRC – no changed
ERR_WRONG_MODE	33	Wrong operation mode
ERR_NOT_CONFIGURED	34	Device/chip was not initialized

The warranty obligations of Kramer Electronics Inc. ("Kramer Electronics") for this product are limited to the terms set forth below:

What is Covered

This limited warranty covers defects in materials and workmanship in this product.

What is Not Covered

This limited warranty does not cover any damage, deterioration or malfunction resulting from any alteration, modification, improper or unreasonable use or maintenance, misuse, abuse, accident, neglect, exposure to excess moisture, fire, improper packing and shipping (such claims must be presented to the carrier), lightning, power surges, or other acts of nature. This limited warranty does not cover any damage, deterioration or malfunction resulting from the installation or removal of this product from any installation, any unauthorized tampering with this product, any repairs attempted by anyone unauthorized by Kramer Electronics to make such repairs, or any other cause which does not relate directly to a defect in materials and/or workmanship of this product. This limited warranty does not cover cartons, equipment enclosures, cables or accessories used in conjunction with this product. Without limiting any other exclusion herein, Kramer Electronics does not warrant that the product covered hereby, including, without limitation, the technology and/or integrated circuit(s) included in the product, will not become obsolete or that such items are or will remain compatible with any other product or technology with which the product may be used.

How Long this Coverage Lasts

The standard limited warranty for Kramer products is seven (7) years from the date of original purchase, with the following exceptions:

1. All Kramer VIA hardware products are covered by a standard three (3) year warranty for the VIA hardware and a standard three (3) year warranty for firmware and software updates; all Kramer VIA accessories, adapters, tags, and dongles are covered by a standard one (1) year warranty.
2. Kramer fiber optic cables, adapter-size fiber optic extenders, pluggable optical modules, active cables, cable retractors, ring mounted adapters, portable power chargers, Kramer speakers, and Kramer touch panels are all covered by a standard one (1) year warranty.
3. All Kramer Cobra products, all Kramer Calibre products, all Kramer Minicom digital signage products, all HighSecLabs products, all streaming, and all wireless products are covered by a standard three (3) year warranty.
4. All Sierra Video MultiViewers are covered by a standard five (5) year warranty.
5. Sierra switchers & control panels are covered by a standard seven (7) year warranty (excluding power supplies and fans that are covered for three (3) years).
6. K-Touch software is covered by a standard one (1) year warranty for software updates.
7. All Kramer passive cables are covered by a ten (10) year warranty.

Who is Covered

Only the original purchaser of this product is covered under this limited warranty. This limited warranty is not transferable to subsequent purchasers or owners of this product.

What Kramer Electronics Will Do

Kramer Electronics will, at its sole option, provide one of the following three remedies to whatever extent it shall deem necessary to satisfy a proper claim under this limited warranty:

1. Elect to repair or facilitate the repair of any defective parts within a reasonable period of time, free of any charge for the necessary parts and labor to complete the repair and restore this product to its proper operating condition. Kramer Electronics will also pay the shipping costs necessary to return this product once the repair is complete.
2. Replace this product with a direct replacement or with a similar product deemed by Kramer Electronics to perform substantially the same function as the original product. If a direct or similar replacement product is supplied, the original product's end warranty date remains unchanged and is transferred to the replacement product.
3. Issue a refund of the original purchase price less depreciation to be determined based on the age of the product at the time remedy is sought under this limited warranty.

What Kramer Electronics Will Not Do Under This Limited Warranty

If this product is returned to Kramer Electronics or the authorized dealer from which it was purchased or any other party authorized to repair Kramer Electronics products, this product must be insured during shipment, with the insurance and shipping charges prepaid by you. If this product is returned uninsured, you assume all risks of loss or damage during shipment. Kramer Electronics will not be responsible for any costs related to the removal or re-installation of this product from or into any installation. Kramer Electronics will not be responsible for any costs related to any setting up this product, any adjustment of user controls or any programming required for a specific installation of this product.

How to Obtain a Remedy Under This Limited Warranty

To obtain a remedy under this limited warranty, you must contact either the authorized Kramer Electronics reseller from whom you purchased this product or the Kramer Electronics office nearest you. For a list of authorized Kramer Electronics resellers and/or Kramer Electronics authorized service providers, visit our web site at www.kramerav.com or contact the Kramer Electronics office nearest you.

In order to pursue any remedy under this limited warranty, you must possess an original, dated receipt as proof of purchase from an authorized Kramer Electronics reseller. If this product is returned under this limited warranty, a return authorization number, obtained from Kramer Electronics, will be required (RMA number). You may also be directed to an authorized reseller or a person authorized by Kramer Electronics to repair the product.

If it is decided that this product should be returned directly to Kramer Electronics, this product should be properly packed, preferably in the original carton, for shipping. Cartons not bearing a return authorization number will be refused.

Limitation of Liability

THE MAXIMUM LIABILITY OF KRAMER ELECTRONICS UNDER THIS LIMITED WARRANTY SHALL NOT EXCEED THE ACTUAL PURCHASE PRICE PAID FOR THE PRODUCT. TO THE MAXIMUM EXTENT PERMITTED BY LAW, KRAMER ELECTRONICS IS NOT RESPONSIBLE FOR DIRECT, SPECIAL, INCIDENTAL OR CONSEQUENTIAL DAMAGES RESULTING FROM ANY BREACH OF WARRANTY OR CONDITION, OR UNDER ANY OTHER LEGAL THEORY. Some countries, districts or states do not allow the exclusion or limitation of relief, special, incidental, consequential or indirect damages, or the limitation of liability to specified amounts, so the above limitations or exclusions may not apply to you.

Exclusive Remedy

TO THE MAXIMUM EXTENT PERMITTED BY LAW, THIS LIMITED WARRANTY AND THE REMEDIES SET FORTH ABOVE ARE EXCLUSIVE AND IN LIEU OF ALL OTHER WARRANTIES, REMEDIES AND CONDITIONS, WHETHER ORAL OR WRITTEN, EXPRESS OR IMPLIED. TO THE MAXIMUM EXTENT PERMITTED BY LAW, KRAMER ELECTRONICS SPECIFICALLY DISCLAIMS ANY AND ALL IMPLIED WARRANTIES, INCLUDING, WITHOUT LIMITATION, WARRANTIES OF MERCHANTABILITY AND FITNESS FOR A PARTICULAR PURPOSE. IF KRAMER ELECTRONICS CANNOT LAWFULLY DISCLAIM OR EXCLUDE IMPLIED WARRANTIES UNDER APPLICABLE LAW, THEN ALL IMPLIED WARRANTIES COVERING THIS PRODUCT, INCLUDING WARRANTIES OF MERCHANTABILITY AND FITNESS FOR A PARTICULAR PURPOSE, SHALL APPLY TO THIS PRODUCT AS PROVIDED UNDER APPLICABLE LAW.

IF ANY PRODUCT TO WHICH THIS LIMITED WARRANTY APPLIES IS A "CONSUMER PRODUCT" UNDER THE MAGNUSON-MOSS WARRANTY ACT (15 U.S.C.A. §2301, ET SEQ.) OR OTHER APPLICABLE LAW, THE FOREGOING DISCLAIMER OF IMPLIED WARRANTIES SHALL NOT APPLY TO YOU, AND ALL IMPLIED WARRANTIES ON THIS PRODUCT, INCLUDING WARRANTIES OF MERCHANTABILITY AND FITNESS FOR THE PARTICULAR PURPOSE, SHALL APPLY AS PROVIDED UNDER APPLICABLE LAW.

Other Conditions

This limited warranty gives you specific legal rights, and you may have other rights which vary from country to country or state to state.

This limited warranty is void if (i) the label bearing the serial number of this product has been removed or defaced, (ii) the product is not distributed by Kramer Electronics or (iii) this product is not purchased from an authorized Kramer Electronics reseller. If you are unsure whether a reseller is an authorized Kramer Electronics reseller, visit our web site at www.kramerav.com or contact a Kramer Electronics office from the list at the end of this document.

Your rights under this limited warranty are not diminished if you do not complete and return the product registration form or complete and submit the online product registration form. Kramer Electronics thanks you for purchasing a Kramer Electronics product. We hope it will give you years of satisfaction.



P/N:



2900-301044

Rev:



1



SAFETY WARNING

Disconnect the unit from the power supply before opening and servicing

For the latest information on our products and a list of Kramer distributors, visit our website where updates to this user manual may be found.

We welcome your questions, comments, and feedback.

The terms HDMI, HDMI High-Definition Multimedia Interface, and the HDMI Logo are trademarks or registered trademarks of HDMI Licensing Administrator, Inc. All brand names, product names, and trademarks are the property of their respective owners.