



PU-44XL-KIT

Express Installation Kit - 4 x 4 HDBaseT™ LITE Matrix
with PU-514L-RX Receivers

OPERATION MANUAL

DISCLAIMERS

The information in this manual has been carefully checked and is believed to be accurate. CYP (UK) Ltd assumes no responsibility for any infringements of patents or other rights of third parties which may result from its use.

CYP (UK) Ltd assumes no responsibility for any inaccuracies that may be contained in this document. CYP (UK) Ltd also makes no commitment to update or to keep current the information contained in this document.

CYP (UK) Ltd reserves the right to make improvements to this document and/or product at any time and without notice.

COPYRIGHT NOTICE

No part of this document may be reproduced, transmitted, transcribed, stored in a retrieval system, or any of its part translated into any language or computer file, in any form or by any means—electronic, mechanical, magnetic, optical, chemical, manual, or otherwise—without express written permission and consent from CYP (UK) Ltd.

© Copyright 2011 by CYP (UK) Ltd.

All Rights Reserved.

Version 1.1 August 2011

TRADEMARK ACKNOWLEDGMENTS

All products or service names mentioned in this document may be trademarks of the companies with which they are associated.



SAFETY PRECAUTIONS

Please read all instructions before attempting to unpack, install or operate this equipment and before connecting the power supply.

Please keep the following in mind as you unpack and install this equipment:

- Always follow basic safety precautions to reduce the risk of fire, electrical shock and injury to persons.
- To prevent fire or shock hazard, do not expose the unit to rain, moisture or install this product near water.
- Never spill liquid of any kind on or into this product.
- Never push an object of any kind into this product through any openings or empty slots in the unit, as you may damage parts inside the unit.
- Do not attach the power supply cabling to building surfaces.
- Use only the supplied power supply unit (PSU). Do not use the PSU if it is damaged.
- Do not allow anything to rest on the power cabling or allow any weight to be placed upon it or any person walk on it.
- To protect the unit from overheating, do not block any vents or openings in the unit housing that provide ventilation and allow for sufficient space for air to circulate around the unit.

REVISION HISTORY

VERSION NO.	DATE	SUMMARY OF CHANGE
v1.00	28/05/13	First release
v1.01	30/05/13	Corrections
v1.02	31/07/13	Added USB Power Cable information
v1.03	16/08/13	Corrected package contents
v1.04	06/11/15	Corrected CEC information

CONTENTS

1. Introduction	6
2. Applications	6
3. Package Contents	6
4. System Requirements	7
5. Features	7
6. Operation Controls and Functions	8
6.1 Front Panel	8
6.2 Rear Panel.....	9
6.3 Side Panel	10
6.4 Remote Control	10
6.5 IR Pin Assignment.....	11
6.6 RS-232 Pin Assignment.....	11
6.7 RS-232 & Telnet Commands.....	12
6.8 Telnet Control.....	13
6.9 Web GUI Control	15
7. Connection Diagram	17
8. Specifications.....	18
9. Acronyms.....	19

1. INTRODUCTION

This 4 by 4 HDMI HDBaseT™ Lite Matrix Express Installation Kit has been developed as a robust and cost effective solution at the heart of any four zone multi-room environment. Supplied complete with a HDBaseT™ Lite Matrix plus four PU-514L-RX receivers, the kit enables an installer to easily and confidently configure a 4-zone multi-room AV system using HDBaseT Lite technology and distribute content throughout the system over a Single CAT5e/6/7 cable infrastructure.

The Express Install Kit supports the transmission of video (resolutions up to 1080p Full HD and 1920x1200@60Hz), multi-channel digital audio, and control via IR, RS-232, or Web GUI/Telnet IP, from four high definition sources to four HDBaseT outputs over a single CAT5e/6/7 cable (up to 60m) for each output.

The PU-44XL-KIT is supplied with 4x PU-514L-RX receivers which utilise the 2-way IR control capabilities of the matrix. Utilise the USB power output from a TV as an optional way of powering the PU-514L-RX receiver unit alternative to a mains power supply.

Use the IP control feature to enable users to access and control the matrix remotely and also allow additional options for integration of third-party control systems. CYP provide control drivers for control systems such as Control 4, RTI, Crestron, AMX, Control FX, and Demopad. These are available at no extra cost.

2. APPLICATIONS

- /// Domestic HDMI Matrix system
- /// Video/TV wall display and control
- /// Security surveillance and control
- /// Commercial advertising, display and control
- /// University Lecture hall display and control
- /// Retail Sales and demonstration

3. PACKAGE CONTENTS

- /// 4x4 HDMI HDBaseT Lite Matrix over 4 CAT5e/6/7
- /// 4x PU-514L-RX Receivers
- /// 4xIR Extender
- /// 4xIR Blaster
- /// 1x24V/2.7A DC adaptor
- /// 1xRemote control
- /// 1xSet Rack Ears (REARS-10)
- /// Operation manual

4. SYSTEM REQUIREMENTS

- /// HDMI equipped source devices, connect with HDMI cables or DVI equipped source, connect with DVI to HDMI cables
- /// HDMI equipped displays (TVs or monitors) or HDMI equipped AV receivers, connect with HDMI cables
- /// Industry standard CAT5e/6/7 cables

5. FEATURES

- /// Supports all v1.3 HDMI resolutions
- /// Supports uncompressed video/audio up to 10.2Gbps
- /// Common supported resolutions: HDTV: 480p, 576p, 720p, 1080i, 1080p, 1080p24; PC: VGA, SVGA, XGA, WXGA, SXGA, UXGA, WUXGA.
- /// HDMI, HDCP and DVI complaint
- /// High Definition Audio supported: Dolby TrueHD, Dolby Digital Plus and DTS-HD Master Audio plus LPCM (up to 192kHz)
- /// Uncompressed data transfer over single CAT cable (60m - CAT5e/6/7)
- /// Supports third-party control systems, with drivers available for: Control FX, AMX, Crestron, RTI, Control 4
- /// Supports HDMI input up to 15m 1080p 8bit or 10m 1080p 12bit.
- /// Supports RS-232, 2-Way IR and Manual Selection Buttons
- /// Selectable EDID settings - TV (downstream) and STD (fixed)
- /// Compact 1U Rack mount design
- /// Supports 3D signals
- /// Supports additional IR Control via a master (ALL) Input/Output
- /// Supports full IP control
- /// Supplied with 4x PU-514L-RX receivers
- /// Choose to power the PU-514L-RX via the USB output from a TV (Cable available separately - APC-USB): * Please note the performance and consistency of USB power outputs from TV's can vary and cannot be guaranteed by CYP.

Note:

1. Do not connect the CONTROL port to the CAT outputs of this device.

6. OPERATION CONTROLS AND FUNCTIONS

6.1 Front Panel

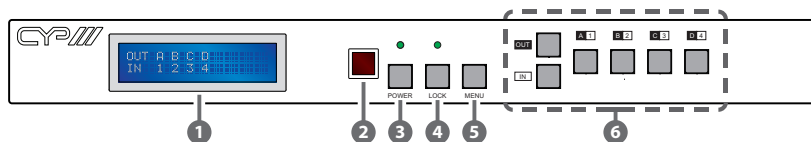

- 1 **LCM** : Displays the setting information of each input and output setting.
- 2 **IR**: IR Receiver window (accepts the remote control signal of this device only).
- 3 **POWER**: Press this button to power the device on/off. The LED will illuminate green when the power is on, red when it is in 'Standby' mode.
- 4 **LOCK**: Press this button to lock all the buttons on the panel; press again to unlock. The LED will illuminate when locked.
- 5 **Menu**: Press once to select EDID setting from STD (internal) 1 or TV (external) 2 then press it again to confirm the selection. Press the the 'MENU' button to confirm the input or output selection. Press multiple times to display the IP settings.
- 6 **1~4/A~D and Out/In**: Press the Out or In button to select the output or input mode and then press the required number or letter button to change the selection.

For example, if outputs A~B need to be set to input 1 and outputs C~D need to be set to input 2, then the following sequence of button presses need to be performed:

Press: Out →A→B→In→1→Menu,
and then press: Out→C→D→In→2→Menu.

Note: If the menu button is not pressed the selection will not be changed.

6.2 Rear Panel

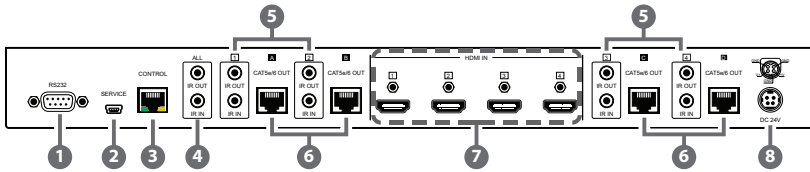

- 1 RS-232:** Connect to a PC or control system with D-Sub 9-pin cable for RS-232 control.
- 2 SERVICE:** Manufacturer use only.
- 3 CONTROL:** Connect to an active network for Telnet/Web GUI control (refer to Section 6.8 for details).

Warning: Please do not connect this port directly to the PC/Laptop as the Telnet function will not work.

- 4 ALL IR OUT:** Connect to the IR blaster for IR signal transmission of the source or display equipment. Place the IR blaster in direct line-of-sight of the equipment to be controlled.

ALL IR IN: Connect to the IR extender for IR signal reception of the remote control of this device or the source and display equipment. Ensure that remote being used is within the direct line-of-sight of the IR extender.

- 5 IR IN 1~4:** Connect the IR extenders for IR signal reception. Ensure that the remote being used is within the direct line-of-sight of the IR extender.

IR OUT 1~4: Connect the IR blasters for IR signal transmission. Place the IR blaster in direct line-of-sight of the equipment to be controlled.

- 6 CAT5e/6/7 OUT A-D:** Connect these CAT outputs to the CAT input port of the receiver units with a single CAT5e/6/7 cable for HDMI Audio/Video and IR control signal transmission.
- 7 HDMI IN 1~4:** Connect to the HDMI input source devices such as a DVD player or a Set-top Box with HDMI cable or DVI to HDMI cable.
- 8 DC24V:** Connect the 24 V DC power supply to the unit and plug the adaptor into an AC outlet.

6.3 Side Panel

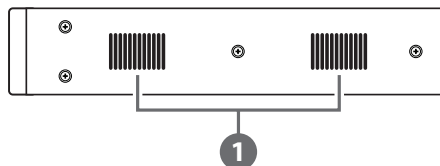

- ① **Ventilator:** These are fan ventilation areas, DO NOT block these areas or cover them with any object. Ensure there is adequate space around the unit for air to circulate.

6.4 Remote Control

- ① **Power:**
Press this button to switch on the device or set it to standby mode.
- ② **IN:**
Input ports selection 1~4.
- ③ **OUT:**
Output ports selection A~D.
Note: IR Matrix control from Zones only require the user to select the desired input.

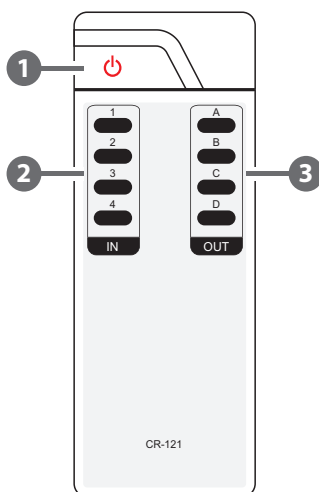

6.5 IR Pin Assignment

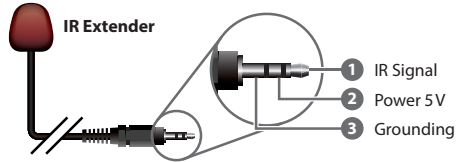
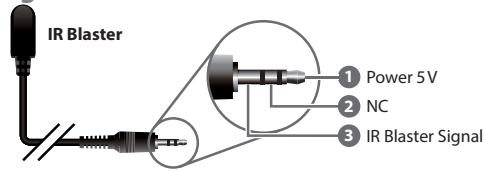

6.6 RS-232 Pin Assignment

PU-44XL-KIT	
PIN	Assignment
1	NC
2	Tx
3	Rx
4	NC
5	GND
6	NC
7	NC
8	NC
9	NC



Remote Control Console	
PIN	Assignment
1	NC
2	Rx
3	Tx
4	NC
5	GND
6	NC
7	NC
8	NC
9	NC

Baud Rate: 19200bps
 Data bit: 8 bits
 Parity: None
 Flow Control: None
 Stop Bit: 1

6.7 RS-232 & Telnet Commands

Command (Case Sensitive)	Description
A1~A4	Switch output A to 1~4
B1~B4	Switch output B to 1~4
C1~C4	Switch output C to 1~4
D1~D4	Switch output D to 1~4
AB...1~CD...4	Switch output ABCD... to 1~4
SETIP<IP><SubNet><GW>	Setting IP. SubNet. GateWay (Static IP)
RSTIP	IP Configuration: Reset to Factory Defaults <DHCP>
IPCONFIG	Display the current IP config
P0	POWER OFF
P1	POWER ON
I1~I4	Switch all outputs to 1~4
ST	Displays the current matrix status and firmware version
RS	System Reset to A1, B2, C3 & D4
EM	Setting EDID MODE. 1=STD, 2=TV
?	Display all the available commands
Quit	Exit (for telnet only)

Note: All the commands will not be executed unless followed with a carriage return. All letters are case-insensitive.

6.8 Telnet Control

Before attempting to use the telnet control, please ensure that both both the Matrix (via the 'LAN /CONTROL' port) and the PC/Laptop are connected to the same active network.

Note: Please do not connect both the Matrix and the PC/Laptop with a single CAT5e/6 cable as it will not access the telnet function.

To access the telnet control in Windows 7, click on the 'Start' menu and type "cmd" in the Search field then press enter.

Under Windows XP go to the 'Start' menu and click on "Run"; type "cmd" with then press enter.

Under Mac OS X, go to Go→Applications→Utilities→Terminal

See below for reference.

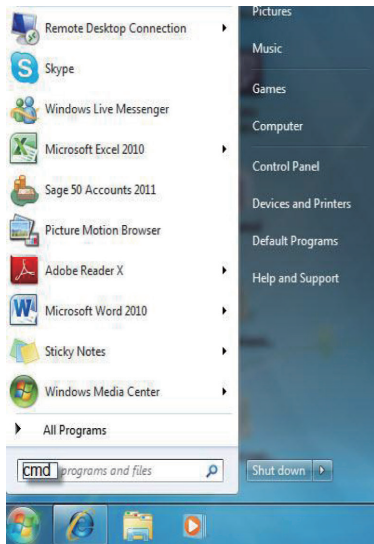

Once in the command line interface (CLI) type "telnet", a space, then the IP address of the unit you wish to control, a space and "23", then hit enter.

Note: The IP address of the Matrix can be displayed on the device's LCM monitor by pressing the Menu button twice.

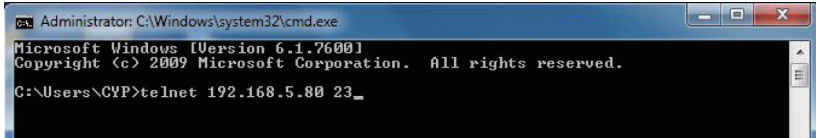

This will bring us into the device which we wish to control. Type "HELP" to list the available commands.

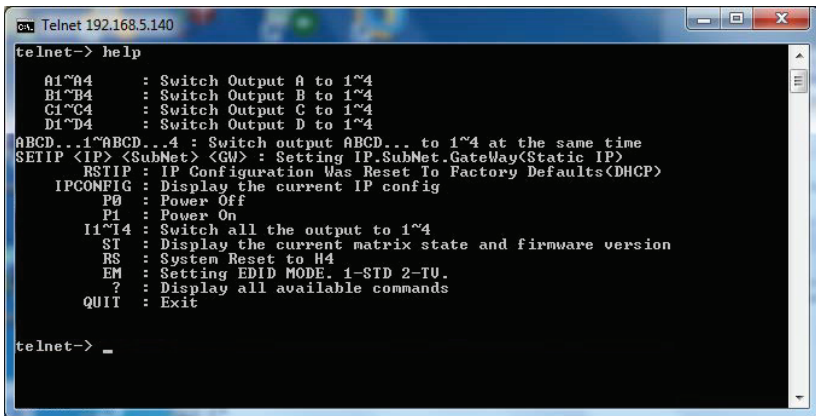

Type "IPCONFIG" To show all IP configurations. To reset the IP, type "RSTIP" and to use a set static IP, type "SETIP" (For a full list of commands, see Section 6.7).

Note: Any commands will not be executed unless followed by a carriage return. Commands are not case-sensitive. If the IP is changed then the IP Address required for Telnet access will also change accordingly.

6.9 Web GUI Control

On a PC/Laptop that is connected to the same active network as the Matrix, open a web browser and type device's IP address on the web address entry bar. The browser will display the device's status, control and User setting pages.

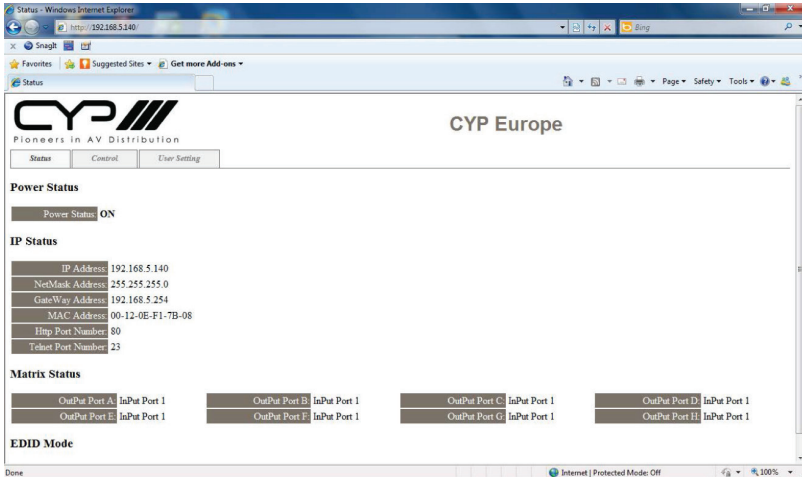

Click on the 'Control' tab to control power, input/output ports, EDID and reset mode.

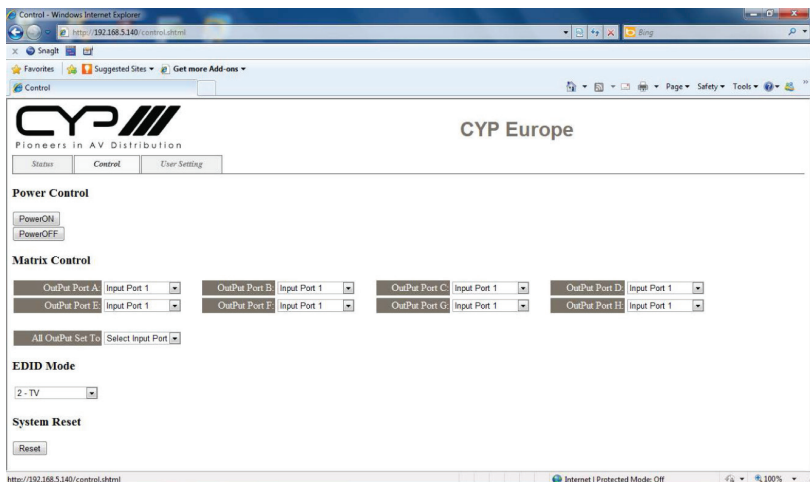

Clicking on the 'User Setting' tab allows you to reset the IP configuration.

The system will ask for a reboot of the device every time any of the settings are changed. The IP address needed to access the Web GUI control will also need to be changed accordingly on the web address entry bar.

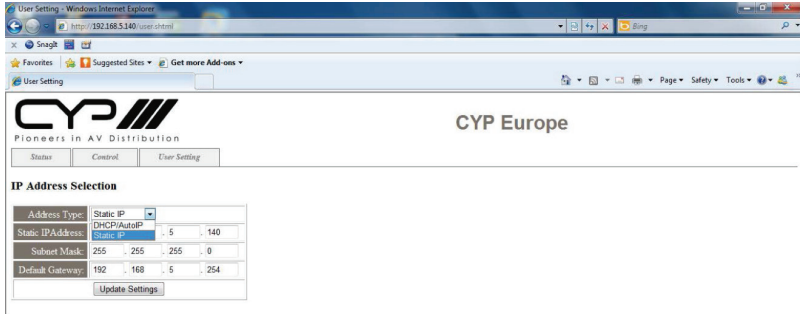

7. CONNECTION DIAGRAM

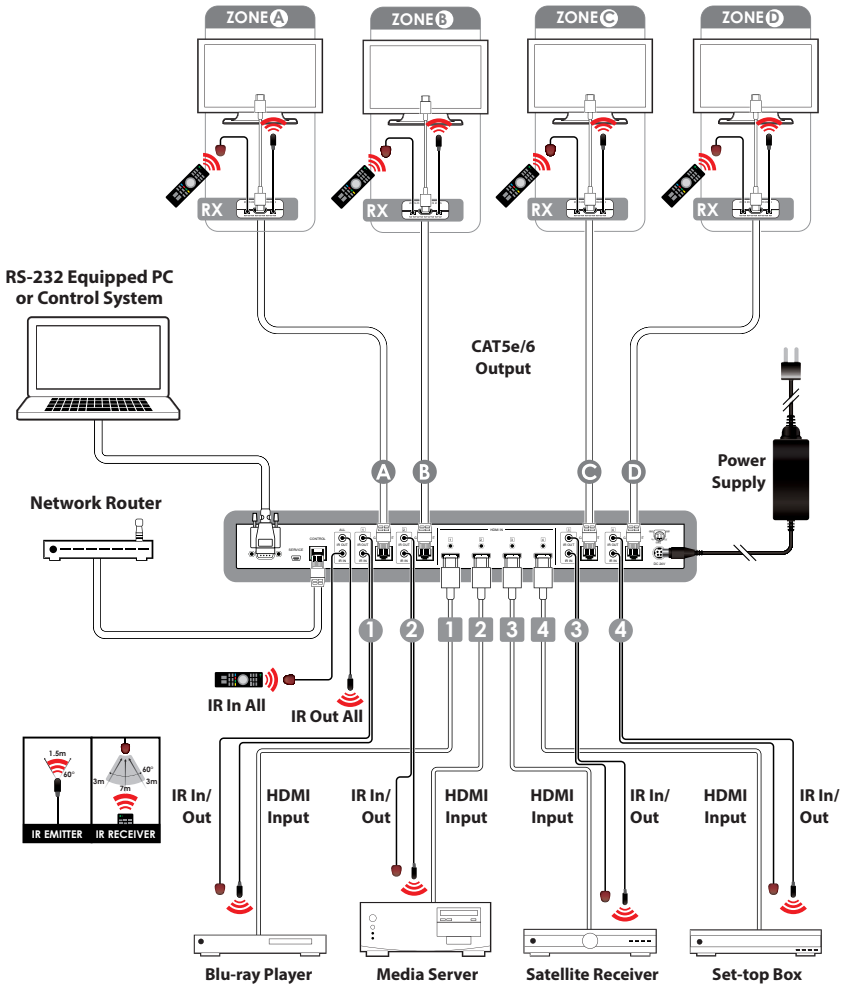

8. SPECIFICATIONS

Video Bandwidth	225 MHz/6.75 Gbps
Input Ports	4×HDMI, 5×IR Extender, 1×CONTROL, 1×RS-232, 1×Mini-USB B type(for firmware update only)
Output Ports	4×CAT5e/6/7, 5×IR Emitter
ESD Protection	Human body model: ±8 kV (air-gap discharge) ±4 kV (contact discharge)
Power Supply	24V/2.7 A DC (US/EU standards, CE/FCC/UL certified)
Dimensions	436 mm(W) × 255 mm(D) × 48 mm(H)
Chassis Material	Metal
Colour	Black
Operating Temperature	0 °C~40 °C/32 °F~104 °F
Storage Temperature	-20 °C~60 °C/-4 °F~140 °F
Relative Humidity	20~90 % RH (non-condensing)
Power Consumption	40W

9. ACRONYMS

ACRONYM	COMPLETE TERM
CLI	Command Line Interface
DTS	Digital Theater System
EDID	Extended Display Identification Data
HDCP	High-bandwidth Digital Content Protection
HDMI	High-Definition Multimedia Interface



CYP (UK) Ltd., Unit 7, Shepperton Business Park, Govett Avenue, Shepperton,
Middlesex, TW17 8BA

Tel: +44 (0) 20 3137 9180 | Fax: +44 (0) 20 3137 6279

Email: sales@cypeurope.com

www.cypeurope.com

v1.04