

The top half of the page features a complex, abstract geometric pattern composed of overlapping triangles and polygons in various shades of blue, ranging from light sky blue to deep navy blue. This pattern transitions into a white background at the bottom.

User Manual  
020-001934-01

# Inspire Series WUXGA

**CHRISTIE®**

## NOTICES

### COPYRIGHT AND TRADEMARKS

Copyright ©2022 Christie Digital Systems USA Inc. All rights reserved.

All brand names and product names are trademarks, registered trademarks or trade names of their respective holders.

### GENERAL

Every effort has been made to ensure accuracy, however in some cases changes in the products or availability could occur which may not be reflected in this document. Christie reserves the right to make changes to specifications at any time without notice. Performance specifications are typical, but may vary depending on conditions beyond Christie's control such as maintenance of the product in proper working conditions. Performance specifications are based on information available at the time of printing. Christie makes no warranty of any kind with regard to this material, including, but not limited to, implied warranties of fitness for a particular purpose. Christie will not be liable for errors contained herein or for incidental or consequential damages in connection with the performance or use of this material. Canadian manufacturing facility is ISO 9001 and 14001 certified.

For the most current technical documentation and office contact information, visit [www.christiedigital.com](http://www.christiedigital.com).

### WARRANTY

Products are warranted under Christie's standard limited warranty, the details of which are available at <https://www.christiedigital.com/help-center/warranties/> or by contacting your Christie dealer or Christie.

### PREVENTATIVE MAINTENANCE

Preventative maintenance is an important part of the continued and proper operation of your product. Failure to perform maintenance as required, and in accordance with the maintenance schedule specified by Christie, will void the warranty.

### REGULATORY

The product has been tested and found to comply with the limits for a Class A digital device, pursuant to Part 15 of the FCC Rules. These limits are designed to provide reasonable protection against harmful interference when the product is operated in a commercial environment. The product generates, uses, and can radiate radio frequency energy and, if not installed and used in accordance with the instruction manual, may cause harmful interference to radio communications. Operation of the product in a residential area is likely to cause harmful interference in which case the user will be required to correct the interference at the user's own expense. Changes or modifications not expressly approved by the party responsible for compliance could void the user's authority to operate the equipment.

### CAN ICES-003 (A) / NMB-003 (A)

이 기기는 업무용 (A 급) 으로 전자파적합등록을 한 기기이오니 판매자 또는 사용자는 이점을 주의하시기 바라며, 가정 외의 지역에서 사용하는 것을 목적으로 합니다.

### ENVIRONMENTAL



The product is designed and manufactured with high-quality materials and components that can be recycled and reused. This symbol  means that electrical and electronic equipment, at their end-of-life, should be disposed of separately from regular waste. Please dispose of the product appropriately and according to local regulations. In the European Union, there are separate collection systems for used electrical and electronic products. Please help us to conserve the environment we live in!

# Content

<b>Introduction</b>	<b>8</b>
Safety and warning guidelines	8
AC/power precautions	9
Installation safety and warning guidelines	9
Laser safety precautions	10
Batteries precautions	10
3D safety information	10
Product labels	12
Projector overview	13
Contact your dealer	13
Key features	14
How the projector works	15
List of components	15
Product documentation	16
Related documentation	16
Built-in keypad	16
Input/Output (I/O) panel	17
IR remote keypad	18
<b>Adjusting the size and position</b>	<b>20</b>
Adjusting the Projected Image	20
Adjusting the Projector's Height	20
Stacking Application	21
Setting the image size preset	22
Adjusting pixel phase	23
Setting the position of display image	23
Setting the digital size of display image	23
Setting the digital position of display image	24
Geometry correction	24
Saving geometry correction	24
Applying geometry correction	24
Adjusting horizontal keystone	25
Adjusting the vertical keystone	25
Adjusting horizontal pincushion	25

Adjusting vertical pincushion . . . . .	26
Adjusting 4-corner . . . . .	26
Enabling auto warp filter . . . . .	26
Adjusting warp filter . . . . .	26
Resetting geometry correction setting . . . . .	27
Configuring warp and blend . . . . .	27
Warping an image . . . . .	27
Downloading a warp from the projector memory . . . . .	28
Enabling basic image blending . . . . .	28
Blending multiple images . . . . .	29
Downloading a blend from the projector memory . . . . .	29
Performing auto warp and blend . . . . .	30
<b>Adjusting the image settings . . . . .</b>	<b>31</b>
Adjusting the brightness . . . . .	31
Adjusting the contrast . . . . .	31
Adjusting the color space . . . . .	31
Adjusting the image sharpness . . . . .	32
Setting up 3D display . . . . .	32
Setting 3D format . . . . .	32
Inverting 3D signal . . . . .	33
Setting the 3D sync output signal . . . . .	33
Setting the frame delay . . . . .	33
Configuring the video settings . . . . .	34
Adjusting black and white video . . . . .	34
Adjusting the color balance . . . . .	34
Adjusting the skin color . . . . .	34
Reducing the temporal noise . . . . .	34
Reducing the MPEG noise . . . . .	35
Setting the input levels . . . . .	35
Adjusting the color gain . . . . .	35
Adjusting the color offset . . . . .	35
Resetting the input levels . . . . .	36
Configuring picture settings . . . . .	36
User configuration . . . . .	37
Setting the contrast ratio . . . . .	37
Enabling the image freeze . . . . .	38
Setting the high dynamic range . . . . .	38
Adjust the color of the image . . . . .	38

Adjusting primary colors . . . . .	39
Setting the wall color . . . . .	40
Adjusting the color value based on gamma setting . . . . .	40
Adjusting the white peaking . . . . .	41
Adjusting the color temperature . . . . .	41
Adjusting the color wheel speed . . . . .	41
Save and Restore user data . . . . .	41
<b>Configuring system settings . . . . .</b>	<b>42</b>
Changing the language . . . . .	42
Adjusting lens settings . . . . .	42
Aligning the image with zoom and focus . . . . .	42
Adjusting lens position . . . . .	43
Saving lens setting . . . . .	43
Applying the previous lens setting . . . . .	43
Locking the lens motor . . . . .	44
Resetting the lens to home position . . . . .	44
Selecting screen image orientation . . . . .	44
Adjusting on-screen display menus . . . . .	44
Determining the on-screen display position . . . . .	45
Showing messages . . . . .	45
Setting the transparency of the on-screen display position . . . . .	45
Changing the splash screen . . . . .	45
Setting time out for on-screen display . . . . .	45
Setting up password protection . . . . .	46
Changing password . . . . .	46
Setting up power mode . . . . .	46
Setting the standby mode . . . . .	46
Setting the AC power . . . . .	47
Setting the time for auto shutdown . . . . .	47
Setting the sleep timer . . . . .	47
Enabling high altitude setting . . . . .	47
Adjusting IR control settings . . . . .	48
Setting 12V trigger . . . . .	48
Setting audio settings . . . . .	48
<b>Configuring communications . . . . .</b>	<b>49</b>
Setting network environment . . . . .	49
Adjusting LAN setting . . . . .	49

- Adjusting WLAN setting . . . . . 50
- Adjusting network setting . . . . . 50
- Setting serial port baud rate . . . . . 50
- Enabling serial port echo . . . . . 50
- Logging on to the web user interface . . . . . 51
- Using the web interface . . . . . 51
- Using the RS-232C interface . . . . . 51
- Re-connecting the network . . . . . 52
- Adjusting the back light settings . . . . . 52
- Setting the hot key . . . . . 52
- Configuring date and time . . . . . 52
  - Setting the clock mode . . . . . 53
  - Setting the date . . . . . 53
  - Setting the time . . . . . 53
  - Setting the daylight saving time . . . . . 53
  - Setting the NTP server . . . . . 53
  - Setting the time zone . . . . . 54
  - Setting the update interval for date and time . . . . . 54
  - Applying the date and time settings . . . . . 54
- Set event schedules . . . . . 54
  - Setting the date and time schedule . . . . . 54
  - Setting the schedule mode . . . . . 54
  - Viewing the event list for the day . . . . . 55
  - Setting the weekly schedule . . . . . 55
  - Resetting the schedule . . . . . 55
- Configuring light source . . . . . 56**
  - Setting light source . . . . . 56
  - Setting constant power . . . . . 57
- Projector information . . . . . 58**
  - Viewing projector information . . . . . 58
  - Changing the language . . . . . 58
  - Selecting a test pattern . . . . . 59
- Configuring input settings . . . . . 60**
  - Setting the main input source . . . . . 60
  - Setting the second input source . . . . . 60
  - Enabling the second input source . . . . . 60

Swapping the main input and second input source . . . . . 60

Setting the size of second input source . . . . . 61

Setting the display layout with two input sources . . . . . 61

    Input sources layout and size . . . . . 61

Setting the timing detection mode . . . . . 62

Setting the input searching method . . . . . 62

Adjusting the sub image . . . . . 63

Enabling low latency mode . . . . . 63

Configuring the HDMI setting . . . . . 63

Configuring the HDMI output . . . . . 64

**Signal connectivity specifications . . . . . 65**

    VGA video formats . . . . . 65

    HDMI video formats . . . . . 68

    HDBaseT video formats . . . . . 71

    Picture-in-picture/picture-by-picture (PIP/PBP) compatibility . . . . . 74

**Regulatory . . . . . 75**

    Safety . . . . . 75

    Laser safety . . . . . 75

    Electro-magnetic compatibility . . . . . 75

        Emissions . . . . . 75

        Immunity . . . . . 76

    Environmental . . . . . 76

    FCC . . . . . 76

    IEC . . . . . 76

    CE . . . . . 77

    Declaration of Conformity for EU countries . . . . . 77

    WEEE . . . . . 77

# Introduction

This manual is intended for Christie qualified installers and trained operators of Inspire Series projection systems.

For complete Inspire Series product documentation and technical support, go to [www.christiedigital.com](http://www.christiedigital.com).

This projector is intended for use in a non-cinema environment.

## Safety and warning guidelines

Read all safety and warning guidelines before installing or operating the projector. This projector must be operated in an environment that meets the operating range specification. Use only the attachments and/or accessories recommended by Christie. Use of others may result in the risk of fire, shock, or personal injury.



**Warning!** If not avoided, the following could result in death or serious injury.

- Do not operate the product without all of its covers in place.
- This product must be installed within a restricted access location not accessible by the general public.
- Only personnel who are trained on the precautions for the restricted access location can be granted entry to the area.
- FIRE HAZARD! Keep hands, clothes, and all combustible material away from the concentrated light beam of the projector.
- TRIP OR FIRE HAZARD! Position all cables where they cannot contact hot surfaces, be pulled, be tripped over, or damaged by persons walking on or objects rolling over the cables.
- SHOCK HAZARD! Disconnect the product from AC before installing, moving, servicing, cleaning, removing components, or opening any enclosure.
- A minimum of four people or appropriately rated lift equipment is required to safely lift, install, or move the product.
- OPTICAL RADIATION HAZARD! Disconnect the power plug from the AC outlet if the product is not being used for an extended period of time.
- Do not allow anything to rest on the power cord.
- Do not use under the following conditions:
  - In extremely hot, cold or humid environments.
    - (i) Ensure that the ambient room temperature is within 5°C to 40°C (storage -10°C to 60°C)
    - (ii) Relative humidity is 10% to 85% RH (storage 5% to 90%RH).
  - In areas susceptible to excessive dust and dirt.
  - Near any appliance generating a strong magnetic field.
  - In direct sunlight.





**Caution!** If not avoided, the following could result in minor or moderate injury.

- Always provide proper ventilation for the product to prevent overheating.
- Only Christie qualified technicians are permitted to open product enclosures.
- All procedures must be performed by Christie qualified technicians.



**Notice.** If not avoided, the following may result in equipment or property damage.

- Do not expose the product to moisture.
- Always use a lens plug when installing or moving the product. This prevents contaminants from entering the product.
- Only use cleaning solutions recommended by Christie. All other cleaning solutions may cause product damage and will void the warranty.

## AC/power precautions

Read all AC/power precautions before installing or operating the projector.



**Warning!** If not avoided, the following could result in death or serious injury.

- FIRE HAZARD! Do not use a power cord, harness, or cable that appears damaged.
- FIRE OR SHOCK HAZARD! Do not overload power outlets and extension cords.
- SHOCK HAZARD! Only use the AC power cord provided with the product or recommended by Christie.
- FIRE AND SHOCK HAZARD! Do not attempt operation unless the power cord, power socket, and power plug meet the appropriate local rating standards.
- SHOCK HAZARD! Do not attempt operation if the AC supply is not within the specified voltage and current, as specified on the license label.
- SHOCK HAZARD! The AC power cord must be inserted into an outlet with grounding.
- SHOCK HAZARD! Disconnect the product from AC before installing, moving, servicing, cleaning, removing components, or opening any enclosure.
- Install the product near an easily accessible AC receptacle.

## Installation safety and warning guidelines

Read all installation safety and warning guidelines before installing the projector.



**Warning!** If not avoided, the following could result in death or serious injury.

- High leakage current present when connected to IT power systems.



**Caution!** If not avoided, the following could result in minor or moderate injury.

- ELECTRICAL and BURN HAZARD! Use caution when accessing internal components.
- Only Christie qualified technicians are authorized to use the tools provided in the toolbox.

## Laser safety precautions

This product is classified as Class 1 Laser Product-Risk Group 2 according to IEC 60825-1:2014 complies with FDA regulations 21 CFR 1040.10 and 1040.11 as a Risk Group 2, LIP (Laser Illuminated Projector) as defined in IEC 62471:2006 except for deviations pursuant to Laser Notice No. 50, dated June 24, 2007.



**Warning!** If not avoided, the following could result in death or serious injury.

- This projector has a built-in Class 4 laser module. Never attempt to disassemble or modify the projector.
- Any operation or adjustment not specifically instructed in the User manual creates the risk of hazardous laser radiation exposure.
- Do not open or disassemble the projector as this may cause damage or exposure to laser radiation.
- Do not stare into beam when the projector is on. The bright light may result in permanent eye damage.
- When turning on the projector, make sure no one within projection range is looking into the lens.
- Follow all installation, operation, adjustment, and maintenance procedures to avoid possible exposure to hazardous laser radiation.

## Batteries precautions

Read the following precautions for your battery:



**Caution!** If not avoided, the following could result in minor or moderate injury.

- Keep new and used batteries away from children.
- Discontinue usage if leakage is found.
- EXPLOSION HAZARD! Dispose of the battery according to local area regulations.



**Warning!** If not avoided, the following could result in death or serious injury.

- CHEMICAL BURN HAZARD! Do not inject the battery.
- INTERNAL BURNS HAZARD! The product contains a coin cell battery and if swallowed can cause internal burns within two hours.
- INTERNAL BURN HAZARD! Seek medical attention if a battery has been swallowed or placed inside any part of the body.
- EXPLOSION OR FIRE HAZARD! Replacement battery must be of the correct type and replaced properly.
- EXPLOSION HAZARD! Do not mechanically cut or crush the battery or dispose of it in a fire or oven.

## 3D safety information

Follow all recommended warnings and precautions before using the 3D function.



**Caution!** If not avoided, the following could result in minor or moderate injury.

- Closely supervise children and teenagers viewing 3D images as they may be more susceptible to health issues associated with them.

## Photosensitive seizure warning and other health risks

Some viewers may experience discomfort when exposed to certain flashing images or lights contained in certain projector pictures or video games.

- Some viewers may experience an epileptic seizure or stroke when exposed to certain flashing images or lights contained in certain projector pictures or video games. If you suffer from, or have a family history of epilepsy or strokes, consult with a medical specialist before using the 3D function. Those without a personal or family history of epilepsy or stroke may have an undiagnosed condition that can cause photosensitive epileptic seizures.
- Pregnant women, the elderly, sufferers of serious medical conditions, those who are sleep deprived, or those under the influence of alcohol should avoid using the 3D functionality.
- If experiencing any of the following symptoms, stop viewing 3D pictures immediately and consult a medical specialist:
  - Altered vision
  - Lightheadedness
  - Dizziness
  - Involuntary movements such as eye or muscle twitching
  - Confusion
  - Nausea
  - Loss of awareness
  - Convulsions
  - Cramps
  - Disorientation

Children and teenagers may be more likely than adults to experience these symptoms. Monitor children and ask if they are experiencing these symptoms.

- Watching 3D projection may also cause motion sickness, perceptual after effects, disorientation, eye strain and decreased postural stability. Christie recommends taking frequent breaks to lessen the potential of these effects. If your eyes show signs of fatigue or dryness or if experiencing any of the above symptoms, immediately discontinue use of this device and do not resume using it for at least thirty minutes after the symptoms have subsided.
- Watching 3D projection while sitting too close to the screen for an extended period of time may damage your eyesight. The ideal viewing distance should be at least three times the screen height. Christie recommends the viewer's eyes are level with the screen.
- Watching 3D projection while wearing 3D glasses for an extended period of time may cause a headache or fatigue. If experiencing a headache, fatigue, or dizziness, stop viewing the 3D projection and rest.
- Do not use the 3D glasses for any other purpose than for watching 3D projection.
- Wearing the 3D glasses for any other purpose (as general spectacles, sunglasses, protective goggles, and so on) may be physically harmful to you and weaken your eyesight.
- Viewing in 3D projection may cause disorientation for some viewers. Do not place the 3D projector near open stairwells, cables, balconies, or other objects that can be tripped over, run into, knocked down, broken, or fallen over.

## Product labels

Learn about the labels that may be used on the product. Labels on your product may be yellow or black and white.

### General hazards

Hazard warnings also apply to accessories once they are installed in a Christie product that is connected to power.

#### Fire and Shock Hazard



To prevent fire or shock hazards, do not expose this product to rain or moisture.  
Do not alter the power plug, overload the power outlet, or use it with extension cords.  
Do not remove the product enclosure.  
Only Christie qualified technicians are authorized to service the product.

#### Electrical Hazard



Risk of electric shock.  
Do not remove the product enclosure.  
Only Christie qualified technicians are authorized to service the product.



**Notice!** If not avoided, the following could result in property damage.



General hazard.

### Laser labels



Do not look into the projector lens when the laser is on. The bright light may result in permanent eye damage.



This projector has been classified as Class 1 Laser Product-Risk Group 2 according to IEC 60825-1:2014, IEC 62471:2006, and IEC 62471-5:2015.



Mount above the heads of children. The use of a ceiling mount is recommended with this product to place it above the eyes of children.

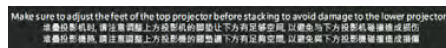

Make sure to adjust the feet of the top projector before stacking to avoid damage to the lower projector.

## Projector overview

The Inspire Series projector is a professional, WUXGA resolution projector system using Digital Light Processing (DLP™) technology from Texas Instruments. It provides high standard of image quality along with high degree of flexibility, providing great alternatives for fixed installation environments to enhance users visual experience.

## Contact your dealer

Record the information about your projector and keep this information with your records to assist with the servicing of your projector. If you encounter a problem with your Christie projector, contact your dealer.

Purchase record
Dealer:
Dealer or Christie Sales/Service contact phone number:
Projector serial number: The serial number can be found on the license label located on the display panel
Purchase date:
Installation date:

### Ethernet settings

Default gateway	
Projector IP address	
Subnet mask	

## Key features

Understand the important features of the projector.

- WUXGA(1920 X1200) resolution with high brightness performance
- Projection lens compatibility:

DWU760-iS/DWU860-iS/DWU960-iS:

- Vertical offset ranges with half image size: +/-110%
- Horizontal offset ranges with half image size: +/-50%

Measurements comply with industry standards where offset is calculated as a ratio of the number of pixels shifted up or down to half image size.

DWU960ST-iS:

- Vertical offset ranges with half image size: +/-110%
- Horizontal offset ranges with half image size: +/-50%

Measurements comply with industry standards where offset is calculated as a ratio of the number of pixels shifted up or down to half image size.

- Christie Twist™ and Mystique™ allow for easy and quick blending and warping  
Support for Mystique™ camera based alignment system (sold separately)
- Full HD 3D technology with frame sequential up to 120Hz
- A wide range of connectivity including HDMI, VGA, HDBaseT, and 3D input/3D output
- 360 degrees projection enabled by laser light source
- Compatible with HDR content
- All video formats can be resized to full screen either horizontally or vertically while maintaining aspect ratio
- The projector can be operated using any of the following:
  - Built-in keypad
  - Infrared (IR) remote keypad
  - Wired remote keypad
  - PC/device using serial communications (Ethernet or RS232)
  - A web page using Ethernet or from a PC or device using a wireless USB dongle (optional)

## How the projector works

The Inspire Series projector accepts a variety of input signals for a wide range of commercial projection applications.

Designed with solid-state illumination light sources and phosphor technology, the red, green and blue color elements are segmented through a phosphor wheel and then modulated by one Digital Micromirror Device (DMD) panel responding to incoming data streams of digitized red, green and blue color information. As these digital streams flow from the source, light from the responding on pixels of the DMD panel is reflected, converged and then projected to the screen through projection lenses, where all pixel reflections are superimposed in sharp full-color images.

## List of components

This projector comes with all the items listed below. Check to make sure your package is complete. If anything is missing, contact your dealer.

- IR Remote
- Product Safety Guide

## Product documentation

For installation, setup, and user information, see the product documentation available on the Christie Digital Systems USA Inc. website at [www.christiedigital.com](http://www.christiedigital.com). Read all instructions before using or servicing this product.

1. Access the documentation from the Christie website:
  - Go to this URL: <https://bit.ly/3fXJcI3> or <https://www.christiedigital.com/products/projectors/all-projectors/inspire-series/>
  - Scan the QR code using a QR code reader app on a smartphone or tablet.



2. On the product page, select the model and switch to the **Downloads** tab.

## Related documentation

Additional information on the projector is available in the following documents.

- *Christie Inspire Series Product Safety Guide (P/N: 0200001932-XX)*
- *Christie Inspire Series Installation and Setup Guide (P/N: 020-001933-XX)*
- *Christie Inspire Series Service Manual (P/N: 020-001935-XX)*
- *Inspire Series Serial API Commands Technical Reference (P/N: 020-103542-XX)*

## Built-in keypad

The built-in keypad controls the projector.

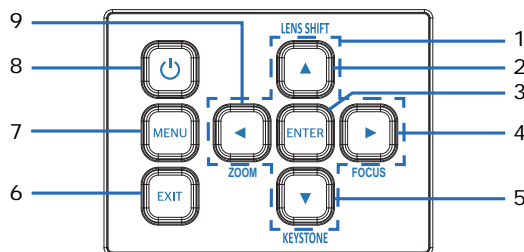

ID	Button	Description
1	Four Directional Select Keys	Use ▲▼◀▶ to select items or make adjustments to your selection.



ID	Button	Description
2	LENS SHIFT ▲	Adjusts the lens setting.
3	ENTER	Confirms your item selection.
4	FOCUS ►	Adjusts the image focus.
5	KEystone ▼	Adjusts keystone.
6	EXIT	Exits the current page and returns to the previous page.
7	MENU	Press MENU to launch the on-screen display (OSD) menu. To exit the OSD, press MENU or EXIT again.
8	Power ⏻	Turns the projector on or off.
9	ZOOM ◀	Adjusts the image size.

## Input/Output (I/O) panel

Identify the components of the Input/Output (I/O) panel.

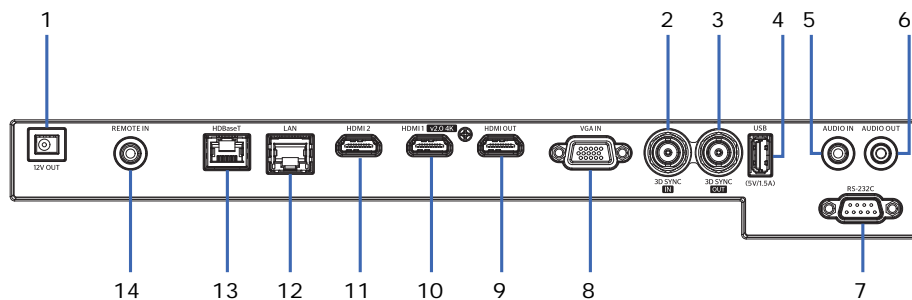

ID	Connector name	ID	Connector name
1	12V OUT	8	VGA IN
2	3D SYNC (IN)	9	HDMI OUT
3	3D SYNC (OUT)	10	HDMI1 (v2.0 4K)
4	USB (5V/1.5A)	11	HDMI2
5	AUDIO IN	12	LAN
6	AUDIO OUT	13	HDBaseT
7	RS232-C	14	REMOTE IN

# IR remote keypad

The IR remote keypad communicates with the projector by way of wireless communications. Use a cable length of 20 m (787.4 inches) or less. If the length of cable exceeds 20 m (787.4 inches), the IR remote keypad may not work correctly.

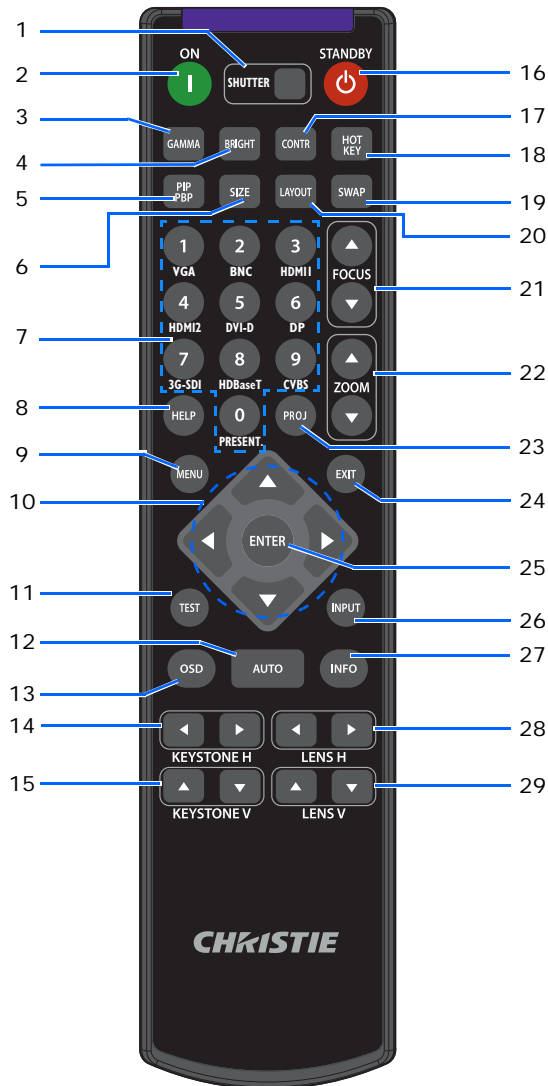

ID	Button	Description
1	SHUTTER	Displays or blanks the video image.
2	ON	Turns the projector on.
3	GAMMA	Adjusts the mid-range levels.

ID	Button	Description
4	BRIGHT	Adjusts the amount of light in the image.
5	PIP PBP	Turns picture-in-picture/picture-by-picture (PIP/PBP) on or off.
6	SIZE	Adjusts the PIP/PBP size.
7	Number keys	Enter a number, such as a channel, value, and so on. The on-screen display (OSD) indicates if a function is not supported.
8	HELP	Displays the instructions for source connection.
9	MENU	Displays the menus.
10	Arrow keys	Adjusts a setting up or down to navigate within a menu.
11	TEST	Displays a test pattern.
12	AUTO	Automatically synchronizes the projector to an input source.
13	OSD	Hides or shows OSD menus.
14	KEYSTONE H	Adjusts the horizontal keystone.
15	KEYSTONE V	Adjusts the vertical keystone.
16	STANDBY	Turns the projector off.
17	CONTR	Adjusts the difference between dark and light.
18	HOT KEY	Selects your preset key quickly.
19	SWAP	Swaps the main and PIP/PBP images.
20	LAYOUT	Adjusts the PIP/PBP layout.
21	FOCUS	Adjusts the focus to improve image clarity as required.
22	ZOOM	Adjusts the zoom to achieve a required image size.
23	PROJ	Changes the IR remote keypad ID. <ul style="list-style-type: none"> <li>• To assign an ID, press <b>PROJ</b> + &lt;<b>1</b> to <b>9</b>&gt;.</li> <li>• To return to the universal IR remote ID, press <b>PROJ</b> + <b>0</b>.</li> </ul>
24	EXIT	Returns to previous level or exit menus if at top level.
25	ENTER	Selects a highlighted menu item, or changes or accepts a value.
26	INPUT	Selects an input for the main or PIP/PBP image.
27	INFO	Displays the projector information.
28	LENS H	Adjusts the position of the image horizontally.
29	LENS V	Adjusts the position of the image vertically.

# Adjusting the size and position

Adjust the projector's size and position. Christie recommends warming the lens before completing these procedures as focus may change as the lens warms.

## Adjusting the Projected Image

Adjust the projected image's height and horizontal tilt for better viewing.

### Adjusting the Projector's Height

The projector is equipped with elevator feet for adjusting the image height.

1. Locate the adjustable foot you want to modify on the underside of the projector.
2. Rotate the adjustable ring clockwise to raise the projector or counter clockwise to lower it.
3. Repeat with the remaining feet as needed.

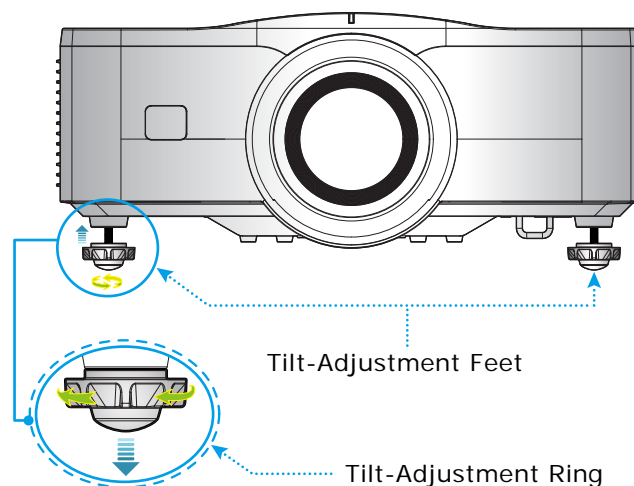



For stacking application, the elevator feet of the upper projector must be adjusted to increase the height of this projector to avoid the interference between two projectors. For more information on stacking projectors, please refer to [Stacking Application](#) on page 21.

## Stacking Application

If two projectors are mounted on top of each other without using a frame, adjust the rubber feet of the upper projector to avoid the interference between the two projectors.

The maximum adjustable range of the rubber foot is 13 mm (0.5 inches).

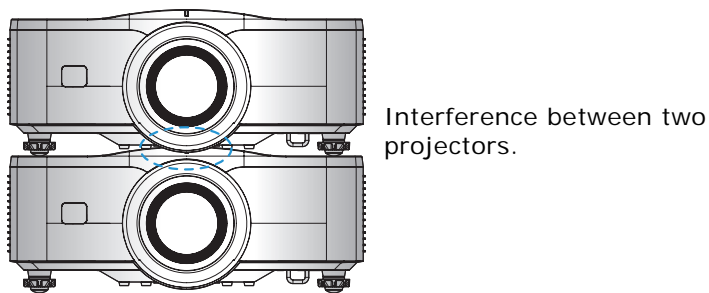
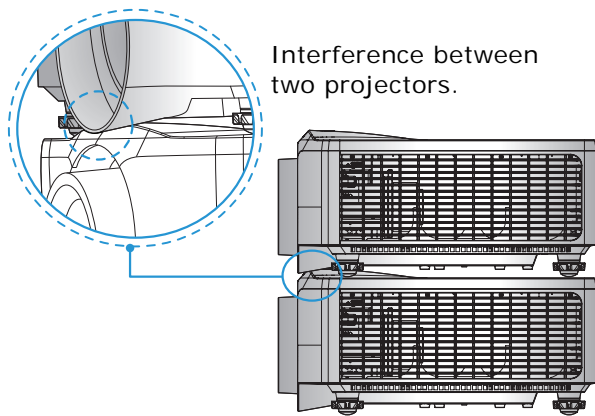
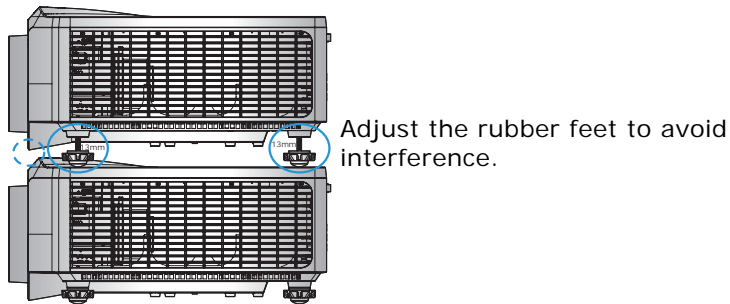

## Setting the image size preset

Set the image size preset to display the image in its native resolution or to resize by maximizing the height, width, both height and width, or to the maximum size while keeping the original aspect ratio.

1. Select **Menu > Size & Position > Size Presets**.
2. Select the appropriate size preset:
  - **Auto**—Display with the detected size.
  - **Native**—Display in its native resolution.
  - **4:3**—Retain 4:3 aspect ratio.
  - **Letterbox**—Make the active content enlarge to the full screen.
  - **Full Size**—Fill the screen, regardless of the source.
  - **Full Width**—Fill display width and keep aspect ratio.
  - **Full Height**—Fill display height and keep aspect ratio.
  - **Custom**—Stretch the display horizontally and vertically without cutting the image display.
  - **3D Mode**—Display 3D content. All other items are grayed out, if 3D Mode is selected.
3. To confirm the selection, press **ENTER**.

## Adjusting pixel phase

Adjust the pixel phase when the image shows shimmer or noise. Pixel phase can adjust the phase of the pixel-sampling clock relative to the incoming signal. This feature is for analog RGB signals only.

1. Select **Menu > Size & Position > Pixel Phase**.
2. Adjust the slider by arrow keys or press **ENTER** to input the values of pixel phase.
3. After inputting the value, press **ENTER** to apply.

## Setting the position of display image

Move the image vertically or horizontally to correct the position of the display image.

1. Select **Menu > Size & Position > Horz Position** or **Vert Position**.
2. Adjust the slider by arrow keys or press **ENTER** to input the values of moving pixels.
3. After inputting the value, press **ENTER** to apply.

## Setting the digital size of display image

These functions are similar technologies as in-camera image processing. Use Digital Horz Zoom or Digital Vert Zoom to enlarge or to compress the display image horizontally or vertically.

1. Select **Menu > Size & Position > Digital Horz Zoom** or **Digital Vert Zoom**.
2. Adjust the slider by arrow keys or press **ENTER** to input the value you selected.
3. After inputting the value, press **ENTER** to apply.

## Setting the digital position of display image

Change the position of the projector's display image horizontally or vertically.



Digital Horz Shift is only available after adjusting the Digital Horz Zoom, and Digital Vert Shift is only available after adjusting the Digital Vert Zoom.

1. Select **Menu > Size & Position > Digital Horz Shift** or **Digital Vert Shift**.
2. Adjust the slider by arrow keys or press **ENTER** to input the value you selected.
3. After inputting the value, press **ENTER** to apply.

## Geometry correction

Modify the geometry of the display image directly on the projector.

Connecting to Christie Twist and Mystique grays out the geometry correction settings on the projector. Uploading warp and blend from Twist and Mystique overwrites the currently applied geometry correction settings. See [Configuring warp and blend](#) on page 27 for more details.

## Saving geometry correction

Save the warp and blend settings to the projector memory. The blend memory saves the edge blend settings, while the warp memory saves the settings of Keystone, Pincushion, 4-Corner, Manual Warp Filter, and image warp.

1. Select **Menu > Size & Position > Geometry Correction > Warp Memory > Save Warp** or **Blend Memory > Save Blend**.
2. To save the geometry setting, select a record.  
One projector can save up to four warps and four blends.
3. To confirm the selection, press **ENTER**.

## Applying geometry correction

Apply the previously saved geometry setting to the projector.

1. Before applying the previous geometry setting, save the geometry setting to the projector.  
See [Saving geometry correction](#) on page 24 for more information.
2. Select **Menu > Size & Position > Geometry Correction > Warp Memory > Apply Warp** or **Blend Memory > Apply Blend**.
3. To apply the specific geometry setting, select the required record.
4. To confirm the selection, press **ENTER**.
5. To erase the applied geometry setting, select **Off**.



## Adjusting horizontal keystone

Use horizontal keystone to correct a keystone image shape in which the left and right borders of the image are unequal in length, and the top and bottom are slanted to one of the sides.

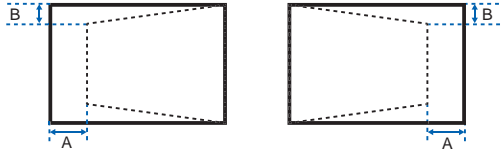

1. Select **Menu > Size & Position > Geometry Correction > Keystone > Horz Keystone**.
2. To adjust the horizontal keystone, adjust the slider by arrow keys or press **ENTER** to input the value you selected.
3. After inputting the value, press **ENTER** to apply.

## Adjusting the vertical keystone

Use vertical keystone to correct a keystone image shape in which the top and bottom borders of the image are unequal in length, and both sides of the image are inclined toward the top or bottom edge.

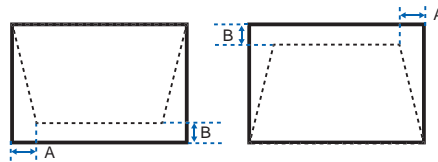

1. Select **Menu > Size & Position > Geometry Correction > Keystone > Vert Keystone**.
2. To adjust the vertical keystone, adjust the slider by arrow keys or press **ENTER** to input the value you selected.
3. After inputting the value, press **ENTER** to apply.

## Adjusting horizontal pincushion

Use horizontal pincushion to correct a pinched image shape in which the horizontal straight lines are curved inwards or horizontal straight lines are curved outwards from the center.

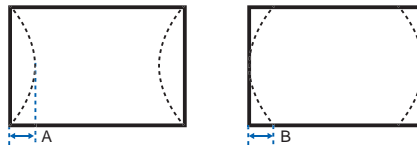

1. Select **Menu > Size & Position > Geometry Correction > Pincushion > Horz Pincushion**.
2. To adjust the horizontal pincushion, adjust the slider by arrow keys or press **ENTER** to input the value you selected.
3. After inputting the value, press **ENTER** to apply.

## Adjusting vertical pincushion

Use vertical pincushion to correct a pinched image shape in which the vertical straight lines are curved inwards or vertical straight lines are curved outwards from the center.

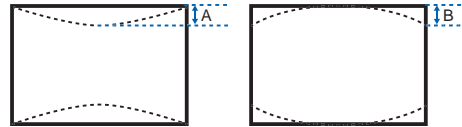

1. Select **Menu > Size & Position > Geometry Correction > Pincushion > Vert Pincushion**.
2. To adjust the vertical pincushion, adjust the slider by arrow keys or press **ENTER** to input the value you selected.
3. After inputting the value, press **ENTER** to apply.

## Adjusting 4-corner

Use 4-corner to correct the four corners of the projector's display image.

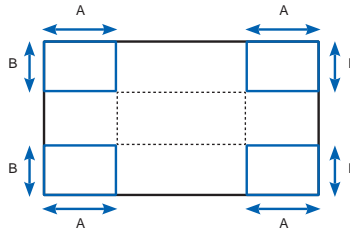

1. Select **Menu > Size & Position > Geometry Correction > 4-Corner**.
2. Select the corner and the direction to adjust.
3. To move the corner, adjust the slider by arrow keys or press **ENTER** to input the value.
4. After inputting the value, press **ENTER** to apply.
5. To adjust the other corner or direction, repeat step 2 to 4.

## Enabling auto warp filter

Improve the sharpness of the image and reduce the ghosting automatically after geometry correction, such as keystone, pincushion, 4-corner, and warping.

1. Select **Menu > Size & Position > Geometry Correction > Auto Warp Filter**.
2. To enable the setting, press **ENTER**.

## Adjusting warp filter

Improve the sharpness of the image after geometry correction, such as keystone, pincushion, 4-corner, and warping. Adjust the warp filter manually to reduce the ghosting.

1. Select **Menu > Size & Position > Geometry Correction > Manual Warp Filter**.
2. To reduce the ghosting in different direction, select **Horz Filter** or **Vert Filter**.

3. Adjust the slider by arrow keys or press **ENTER** to input the value.
4. After inputting the value, press **ENTER** to apply.

## Resetting geometry correction setting

Reset all geometry correction parameters back to default, including warp and blend settings.

1. Select **Menu > Size & Position > Geometry Correction > Reset to Default**.
2. Press **ENTER**.

## Configuring warp and blend

By blending multiple images, you can combine several projectors to create a larger and seamless image. When the projection screen is not perfectly flat or rotated at an angle, warp the image to fit on the irregular surface.

### Warping an image

Christie Twist offer various manual warping options to adjust the image shape with minimal performance impact. Refer to the Christie website ([www.christiedigital.com](http://www.christiedigital.com)) for product information and documentation.

1. Connect the projector and computer to the same network and subnet.
2. To add a projector to a computer, from the Twist menu, click **Home > Add**.
  - To manually connect the projector with Twist, use port 3003.
  - Connecting to Twist grays out the Geometry Correction settings on the projector.

3. Select a record number to save the warp.

You can save up to four warp settings.

4. In Twist, configure warp settings.

Use the test patterns in Twist to help with image shaping.

For more information about creating warp files in Twist, refer to *Twist User Guide (P/N: 020-101380-XX)*.

5. To send the warp settings to the projector, on the canvas, right-click a projector window and select **Send Warp**.
6. To save the warp settings on the projector, click **File > Save** or **Save As**.

When removing the projector from Twist, or closing the program, the projector automatically saves the currently applied warp settings to its warp memory.

7. To change the name when saving warps on the projector, or update the memory location of the warp, click **Properties**.

The changed name shows on both Twist and the projector.



Christie Twist can be upgraded to Twist Premium and Twist Pro that provides more advanced warping features. Refer to the Christie website ([www.christiedigital.com](http://www.christiedigital.com)) for product information and documentation.

## Downloading a warp from the projector memory

Use Twist to download the warp file saved on the projector memory.

1. Before downloading the previous warp file, save the warp setting to the projector memory.
2. On the canvas, click a projector window.
3. Click **File > Warp**.
4. In the Download from Memory Location list, select the required record.
5. To download the selected warp setting, click **OK**.
6. To apply the warp setting to the projector, on the canvas, right-click a projector window and select **Send Warp**.

## Enabling basic image blending

Configure blends directly on the projector to increase or decrease the borders of an individual image, so it blends with a neighboring image to create a single, seamless image.

You can set blends on a projector when not using Christie Twist and Mystique. Connecting to Twist and Mystique grays out the blend settings on the projector. Applying blends from Twist and Mystique overwrites the blends directly set on the projectors.

1. Select **Menu > Size & Position > Geometry Correction > Blend Area**.
2. Choose a side to blend in with the other projectors.
3. To set up the starting position, select **Start Pixel**.
4. Adjust the slider by arrow keys or press **ENTER** to input the starting position.
5. After inputting the starting position, press **ENTER**.
6. To set up the size of blend area, select **Pixel Height**.
7. Adjust the slider by arrow keys or press **ENTER** to input the width of blend area.
8. After inputting the size of blend area, press **ENTER**.
9. To set the gamma value of the blend area, select **Blend Gamma**.
10. After selecting a gamma value, press **ENTER**.
11. To apply the settings, select **Enable**.
12. Press **ENTER**.
13. To save the blend setting, select **Menu > Size & Position > Geometry Correction > Blend Memory > Save Blend**.
14. To set up the other side of blend area, repeat step 2 to 13.

## Blending multiple images

Use Christie Twist to manually configure edge blends and apply them to the projectors.

Christie Twist Premium and Twist Pro offer advanced blending options. Refer to the Christie website ([www.christiedigital.com](http://www.christiedigital.com)) for product information and documentation.

1. Connect the projector and computer to the same network and subnet.
2. To add a projector to a computer, from the Twist menu, click **Home > Add**.
  - To manually connect the projector with Twist, use port 3003.
  - Connecting to Twist grays out the Geometry Correction settings on the projector.
3. Select a record number to save the blend setting.

You can save up to four blend settings.

4. In Twist, configure edge blend settings.

Use the test patterns in Twist to assist in adjusting the blend area.

For more information about creating blend files in Twist, refer to *Twist User Guide (P/N: 020-101380-XX)*.

5. To send the blend settings to the projector, on the canvas, right-click a projector window and select **Send Blend**.
6. Repeat step 2 to 5 for the remaining projectors.

For multiple projectors, use Twist to identify the projectors.
7. To save the warp file on the projector, click **File > Save** or **Save As**.

When removing the projector from Twist, or closing the program, the projector automatically saves the currently applied blend settings to its blend memory.
8. To change the name when saving blends on the projector, or update the memory location of the blend, click **Properties**.

The changed name shows on both Twist and the projector.

## Downloading a blend from the projector memory

Use Twist to download the blend file saved on the projector memory.

1. Before downloading the previous blend file, save the blend setting to the projector memory.
2. On the canvas, click a projector window.
3. Click **File > Blend/Mask/B.U**.
4. In the **Download Blend** dialog, select the required record.
5. To download the selected blend setting, click **OK**.
6. To apply the blend setting to the projector, on the canvas, right-click a projector window and select **Send Blend**.

## Performing auto warp and blend

Use Mystique (sold separately) to perform automatic warp, blend, and more advanced geometry settings. Mystique is an automated camera-based alignment and recalibration solution that lets you quickly stage, install, align, calibrate, and maintain multi-projection systems.

Refer to the Christie website ([www.christiedigital.com](http://www.christiedigital.com)) for product information and documentation.

# Adjusting the image settings

Learn how to adjust the projector image.

## Adjusting the brightness

Adjust the intensity of the image.

1. Select **Menu > Image Settings > Brightness**.
2. Adjust the slider by arrow keys or press **ENTER** to input the value.
3. After inputting the value, press **ENTER** to apply.

## Adjusting the contrast

Adjust the degree of difference between the lightest and darkest parts of the image and changes the amount of black and white in the image.

1. Select **Menu > Image Settings > Contrast**.
2. Adjust the slider by arrow keys or press **ENTER** to input the value.
3. After inputting the value, press **ENTER** to apply.

## Adjusting the color space

Determine how the color components are decoded for accurate color in the display.

1. Select **Menu > Image Settings > Color Space**.
2. If projector does not detect the correct input signal while **Auto** is enabled, disable **Auto** by pressing **ENTER** to select color space manually.
3. To match up with the input signal, select appropriate color space:
  - Auto
  - RGB

- RGB Full
  - RGB Limited
  - YUV
    - REC709
    - REC601
4. To confirm the selection, press **ENTER**.

## Adjusting the image sharpness

Adjust the edge clarity of the image.

1. Select **Menu > Image Settings > Detail**.
2. Select the sharpness:
  - Maximum
  - High
  - Normal
  - Low
  - Minimum
3. To confirm the selection, press **ENTER**.

## Setting up 3D display

Use the functions in 3D Display menu to make the timing adjustment and environment necessary for displaying 3D images.

### Setting 3D format

Set up the 3D format according to the 3D input signal.

1. Select **Menu > Image Settings > 3D Display > 3D Enable**.
2. Select the appropriate 3D format:
  - Auto
  - Frame Packing
  - Side by Side
  - Top and Bottom
  - Frame Sequential
  - Off
3. To confirm the selection, press **ENTER**.



## Inverting 3D signal

3D images consist of a series of images (frames) that alternate quickly between two slightly different view points, corresponding to our left and right eyes. When these frames are displayed fast enough and viewed with 3D glasses synchronized to the left/right (L/R) changes, the resulting image appears with the same depth and perspective that is sensed in the real world.

If the projector generates the sync internally and content is displayed without 3D sync in the cable connected to the projector, there is a 50% chance that the content is displayed with the left/right eyes swapped. This function is used for swapping the sequence of the image to make the resulting image appear normally.

1. Select **Menu > Image Settings > 3D Display > 3D Invert**.
2. To swap, press **ENTER**.

## Setting the 3D sync output signal

This function is used for controlling and processing the 3D sync output signal.

1. Select **Menu > Image Settings > 3D Display > 3D Sync Out**.
2. Select the appropriate 3D sync out setting.
  - **To Emitter**—If the 3D sync out port is connected to an emitter, select **To Emitter** to transmit 3D signal to emitter and give to 3D glasses.
  - **To Next Projector**—Multiple projectors 3D application only. Select **To Next Projector** when the 3D sync out port is not connected to an emitter.
3. To confirm the selection, press **ENTER**.

## Setting the frame delay

Adjust the frame delay which eliminates the odd colors and cross talk caused by timing difference. Frame delay is the time difference between the first 3D signal being given and the result being executed from current projector.

1. Select **Menu > Image Settings > 3D Display > Frame Delay**.
2. Adjust the slider by arrow keys or press **ENTER** to input the value.
3. After inputting the value, press **ENTER** to apply.

## Configuring the video settings

Configure the video settings to optimize the image performance, such as applying color to black and white videos, reducing luminance component noise, and so on.

### Adjusting black and white video

Adjust a video image from black and white to fully saturated color. This feature is for video sources only.

1. Select **Menu > Image Settings > Video Options > Color**.
2. Adjust the slider by arrow keys or press **ENTER** to input the value.
3. After inputting the value, press **ENTER** to apply.

### Adjusting the color balance

Adjust the red-green color balance in NTSC video images. NTSC, named after the National Television System Committee, is the analog video color system used in North America and most of the South America countries. This feature is for NTSC video sources only.

1. Select **Menu > Image Settings > Video Options > Tint**.
2. Adjust the slider by arrow keys or press **ENTER** to input the value.
3. After inputting the value, press **ENTER** to apply.

### Adjusting the skin color

Adjust the color tone of human skin in videos.

1. Select **Menu > Image Settings > Video Options > Skin Color**.
2. Select appropriate skin color tone.
3. To confirm the selection, press **ENTER**.

### Reducing the temporal noise

Remove the luminance component noise of the low light videos.

1. Select **Menu > Image Settings > Video Options > Temporal Noise Reduction**.
2. Select appropriate level for temporal noise reduction.
3. To confirm the selection, press **ENTER**.

## Reducing the MPEG noise

MPEG compression causes block noise appears like small blocks in the image, and the image compression algorithms result in mosquito noise around the sharp edges in the image. This function is used to reduce the MPEG noise.

1. Select **Menu > Image Settings > Video Options > MPEG Noise Reduction**.
2. Select appropriate level for MPEG noise reduction.
3. To confirm the selection, press **ENTER**.

## Setting the input levels

If the image is displayed by an analog signal, such as VGA signal, the image may have odd color on the screen. These functions are used to adjust gain and offset error and correct the color.

### Adjusting the color gain

Set the color gain to correct the color intensity of the image. This function is used when the image is displayed by VGA or component and the color is incorrect.

1. Select **Menu > Image Settings > Input Levels**.
2. Select appropriate color gain:
  - Red Gain
  - Green Gain
  - Blue Gain
3. Adjust the slider by arrow keys or press **ENTER** to input the value.
4. After inputting the value, press **ENTER** to apply.

### Adjusting the color offset

Set the color gain to correct the degree of color difference of the image. This function is used when the image is displayed by VGA signal and the color is incorrect.

1. Select **Menu > Image Settings > Input Levels**.
2. Select appropriate color offset:
  - Red Offset
  - Green Offset
  - Blue Offset
3. Adjust the slider by arrow keys or press **ENTER** to input the value.
4. After inputting the value, press **ENTER** to apply.

## Resetting the input levels

Reset all input levels parameters back to default.

1. Select **Menu > Image Settings > Input Levels > Reset to Default**.
2. Press **ENTER**.

## Configuring picture settings

Depending on display content, choose the most suitable picture settings. Different picture settings have different color temperature, brightness, and so on.

1. Select **Menu > Image Settings > Picture Settings**.
2. Select the appropriate picture setting:
  - **Video**—Used for theater application. It sets the color temperature to 6300K with 60% of maximum brightness.
  - **Bright**—Used for large size or high brightness application. It sets the color temperature to 7500K with 100% brightness.
  - **Enhanced**—Used for images with richly saturated and vivid color. It is based on brightness mode.
  - **REC709**—Used for high-definition television. It sets the color temperature to 6500K with 80% of the maximum brightness.
  - **DICOM SIM**—Used for high contrast content, such as X-ray diagram. It sets the color temperature to 7500K with 100% brightness.
  - **Blending**—Used for multiple projector application. It sets the color temperature to 7500K with 90% of maximum brightness.
  - **HDR**—Displays High Dynamic Range (HDR) content.
  - **3D**—Plays 3D videos.
  - **2D High Speed**—Displays 2D input signal at 120Hz.
  - **User**—Customized picture setting. See [User configuration](#) on page 37 for more details of creating a customized picture setting.
3. To confirm the selection, press **ENTER**.

## User configuration

Customize the picture setting by adjusting the brightness, contrast, input levels, color temperature, gamma, detail, white peaking, and so on.

1. Adjust the parameters to customize user's picture setting:
  - Video
  - Bright
  - Enhanced
  - REC709
  - DICOM SIM
  - Blending
  - HDR
  - 3D
  - 2D High Speed
2. Select **Menu > Image Settings > User Configuration**.
3. Press **ENTER**.

## Setting the contrast ratio

Use contrast enhancement function to raise the contrast ratio.

1. Select **Menu > Image Settings > Contrast Enhancement**.
2. Select the appropriate calculation method for contrast ratio:
  - **Dynamic Black™**—Enable the function to automatically adjust the contrast ratio for video sources. It improves the black level in dark scenes by reducing the light output.
  - **Speed**—Adjust the speed of the light source correction. The value ranges from 1 to 15. A lower value makes the correction slower and less aggressive while a higher value results in the faster correction.
  - **Strength**—Set the strength of the dynamic contrast adjustment. The value ranges from 0 to 3, the higher the value the stronger the correction.
  - **Level**—Adjust the light source when the brightness level of the current content gets lower than the set value. The value ranges from 50% to 100%. The higher the value, the larger the range to adjust the light source.
  - **Real Black**—Enable the function to automatically increase the contrast ratio by turning off the laser light when black image is detected.
  - **Lights Out Timer**—Set a timer for the laser light to turn off after detecting black content. The set value ranges from 0s to 20s.

- **Lights Out Signal Level**—Set a black level value as the threshold for the Real Black function. The value can be selected from 0 to 5, with 0 being the darkest black and 5 being the brightest.
  - **Reset to Default**—Reset the function settings to factory default values.
3. To confirm the selection, press **ENTER**.

## Enabling the image freeze

Pause the display screen despite any change in the source device.

1. Select **Menu > Image Settings > Image Freeze**.
2. To pause the screen, check **Image Freeze**.
3. To unfreeze the screen, press any button on the keypad or remote control.
4. Select **Yes**.

## Setting the high dynamic range

High dynamic range (HDR) is set to increase the dynamic range which allows the full spectrum of the image to be seen. HDR significantly expands the range of contrast ratio and color to show a more realistic and natural image. After enabling this function, you can see details in the dark, at the same time, the bright part of the image is still visible.

1. Select **Menu > Image Settings > HDR**.
2. Select appropriate setting for HDR:
  - **Auto**—Auto detect HDR content or off to disable it.
  - **HDR1**—Low HDR effect, used for bright images to increase the color saturation.
  - **HDR2**—Medium HDR effect, used for standard images to make them look more realistic and natural.
  - **HDR3**—Medium HDR effect, used for video content to improve image details.
  - **HDR4**—Strong HDR effect, used to improve image details in dark scenes.
3. To confirm the selection, press **ENTER**.

## Adjust the color of the image

Calibrate the accuracy of primary colors and the wall color, which can change because of lighting and environmental factors. Lighting and other environmental factors may slightly change how these colors appear on your screen. While the change is negligible in most cases, you may prefer to recover the originally intended color performance before trying to match colors from several projectors.

## Adjusting primary colors

To achieve consistency use a color meter to measure the native primary colors—red, green, blue, and white, as they appear on the screen. Use hue, saturation and gain (HSG) to adjust each color component to essentially calibrate a projector to its surroundings, compensating for factors such as screen type, lamp and/or ambient lighting, and improves color accuracy and consistency in a group of projectors. It ensures a good starting point for further customizing and matching; however, is not critical for all installations.

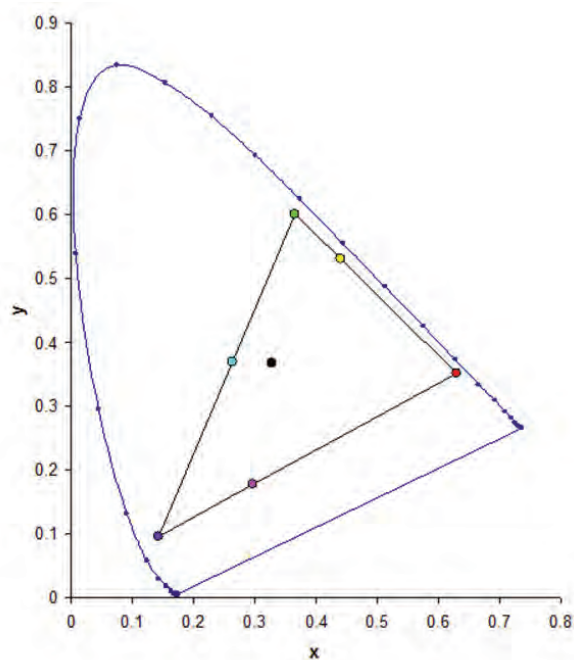

1. Select **Menu > Image Settings > Color Matching > HSG Adjustment**.
2. To enable HSG adjustment, check **HSG Enable**.
3. Select one primary color (red, green, blue, cyan, magenta, or yellow).
4. To view a specific color while adjusting, press **ENTER** to enable **Auto Test Pattern**.
5. To edit hue of the primary color, adjust the slider or enter the color values of the primary color component you selected until you are satisfied with the colors.  
 Hue values reflect the number of degrees of rotation around the wheel from the original color of the pixel. Increasing the value indicates counterclockwise rotation and decreasing the value indicates clockwise rotation.
6. To confirm the selection, press **ENTER**.
7. To edit saturation of the primary color, adjust the slider or enter the color values of the primary color component you selected until you are satisfied with the colors.  
 Saturation values reflect the color shifting away from the primary color or toward white.
8. To confirm the selection, press **ENTER**.

9. To edit gain of the primary, adjust the slider or enter the color values of the primary color component you selected until you are satisfied with the colors.  
Increasing value indicates increasing the lightness, and decreasing the value indicates decreasing it to black.
10. To confirm your selection, press **ENTER**.
11. Repeat steps 3 to 9 for each primary color component, except white.
12. To edit the color of white by three components—red, blue and green—adjust the slider or enter the values until you are satisfied with the white.
13. To confirm your selection, press **ENTER**.
14. To reset the primary colors to their defaults, select **Reset to Default**.
15. To reset back to default setting, press **ENTER**.

## Setting the wall color

Set the wall color so the projector can enhance the color performance customized for the specific wall.

1. Select **Menu > Image Settings > Color Matching > Wall Color**.
2. Select the preferred setting:
  - White
  - Gray 130
  - Light Yellow
3. Press **ENTER**.

## Adjusting the color value based on gamma setting

Adjust the color values to give a more detailed displayed image.

1. Select **Menu > Image Settings > Advanced Image Settings > Gamma**.
2. Select the appropriate option:
  - Video
  - Film
  - Bright
  - CRT
  - DICOM
3. Press **ENTER**.



## Adjusting the white peaking

Use white peaking to adjust the color of white. The maximum value of white peaking, 100, can increase the brightness of white to near 100%.

1. Select **Menu > Image Settings > Advanced Image Settings > White Peaking**.
2. Adjust the slider by arrow keys or press **ENTER** to input the value.
3. Press **ENTER**.

## Adjusting the color temperature

Adjust the color temperature as expressed in degrees Kelvin.

1. Select **Menu > Image Settings > Advanced Image Settings > Color Temperature**.
2. Select appropriate color temperature:
  - **Warmest**—Set the color temperature to 5500K.
  - **Warm**—Set the color temperature to 6500K.
  - **Cool**—Set the color temperature to 7500K.
3. Press **ENTER**.

## Adjusting the color wheel speed

Adjust the color wheel speed, which affects the projector's noise level, lifetime, and eliminates the rainbow phenomenon.



The color wheel speed adjustment is available only for DWU960-iS and DWU960ST-iS.

1. Select **Menu > Image Settings > Advanced Image Settings > Color Wheel Speed**.
2. Select appropriate color temperature:
  - **2X**—Increase the projector's lifetime and reduce the noise level.
  - **3X**—Eliminate the rainbow phenomenon.
3. Press **ENTER**.

## Save and Restore user data

User can save the projector settings as user data and reload the settings later.

1. Select **Menu > Image Settings > Advanced Image Settings > Backup Restore**.
  - **Save**—Save all of the projector settings as user data. User can save up to five records.
  - **Restore**—Load the previously saved user data.

# Configuring system settings

Learn how to configure the system settings.

## Changing the language

Choose the language you want displayed on projector display panel and on-screen display.

1. Select **Menu > Configuration > Language**.  
You can also select **Menu > Language**.
2. Select the appropriate language.
3. Press **ENTER**.

## Adjusting lens settings

Adjust various lens settings including the lens type, zoom, focus, lens position, memorizing lens position and locking the lens motors.

## Aligning the image with zoom and focus

Ensure that the image reflected from the digital micromirror device (DMD) is parallel and centered with the lens and screen.

1. Display an image or test pattern that can be used to analyze image focus and geometry.
2. Press **FOCUS** on keypad or remote control.  
You can also select **Menu > Configuration > Lens Settings > Focus**.
3. Use the up and down arrow keys to zoom in or out of the image.
4. To exit the menu, press **EXIT**.
5. Press **ZOOM** on keypad or remote control.  
You can also select **Menu > Configuration > Lens Settings > Zoom**.
6. Use the up and down arrow keys to adjust the focus of the image.

7. To exit the menu, press **EXIT**.
8. To refine your adjusts, repeat steps 2 to 7.



Before adjusting the focus of DWU960ST-iS, use the lens shift function to move the lens downward to increase the gap between the lens and the ID. This makes the distance value clearer and easier to adjust the floating ring to the correct position manually.

## Adjusting lens position

Shift the lens to the specific position.

1. Display an image or test pattern that can be used to analyze image location.
2. Press **LENS SHIFT** (up button) on keypad or **LENS H/LENS V** on remote control.  
You can also select **Menu > Configuration > Lens Settings > Lens Shift**.
3. Use the arrow keys to adjust the lens position.
4. To exit the menu, press **EXIT**.

## Saving lens setting

Save the lens position, zoom and focus. One projector can save maximum up to five lens settings.

1. Select **Menu > Configuration > Lens Settings > Lens Shift Memory > Save Current Settings**.
2. To save the lens setting, select an empty record.
3. To confirm the selection, press **ENTER**.

## Applying the previous lens setting

Apply the previous lens setting.

1. Before applying the previous lens setting, you must save the lens setting.  
See [Saving lens setting](#) on page 43 for more details.
2. Select **Menu > Configuration > Lens Settings > Lens Shift Memory > Apply Position**.
3. To apply specific lens setting, select the required record.
4. To confirm the selection, press **ENTER**.

## Locking the lens motor

Prevent all lens motors from moving. It disables the zoom, focus, and offset settings, locking out any changes and overriding all other lens features. This feature prevents accidental lens position changes in multiple projectors installations.

1. Select **Menu > Configuration > Lens Settings > Lock all Lens Motors**.
2. To enable locking of all lens motors, select **Locked**.
3. To unlock all lens motors, select **Allow**.
4. To confirm the selection, press **ENTER**.

## Resetting the lens to home position

Set the lens offset back to the home position.

1. Select **Menu > Configuration > Lens Settings > Lens Calibration**.  
You can also press **LENS** on keypad or **LENS H/LENS V** on remote control.
2. To start the lens calibration, press **ENTER**.
3. To confirm the selection, select **OK**.

## Selecting screen image orientation

Specify the orientation to use for the image. The projector supports front projection, rear projection, front projection inverted, or rear projection inverted.

1. To invert the projection image, select **Menu > Configuration > Ceiling Mount**.
2. Select appropriate ceiling mount settings:
  - **Auto**—Detect the orientation automatically.
  - **Off**—Disable the ceiling mount setting.
  - **On**—Enable the ceiling mount setting.
3. To confirm the image orientation, press **ENTER**.
4. To do a rear projection, select **Menu > Configuration > Rear Projection**.
5. To swap, press **ENTER**.

## Adjusting on-screen display menus

Adjust various on-screen display (OSD) settings including the position, OSD transparency and timing for OSD to disappear.

## Determining the on-screen display position

Adjust the location of the on-screen display (OSD) menus.

1. Select **MENU > Configuration > Menu Preferences > Menu Horz Offset** or **Menu Vert Offset**.
2. To determine the location on the screen where you want OSD to appear, adjust the slider by arrow keys or press **ENTER** to input the value.
3. After inputting the value, press **ENTER** to apply.

## Showing messages

Enable or disable the on screen message dialogs. For example, input source, IP Address, Slot information, Gamma information, and so on.

1. Select **Menu > Configuration > Menu Preferences > Show Messages**.
2. To swap, press **ENTER**.

## Setting the transparency of the on-screen display position

Change the on-screen display (OSD) menus background to be transparent. As the value increases, more of the image behind the menu is visible.

1. Select **MENU > Configuration > Menu Preferences > Menu Transparency**.
2. Adjust the slider by arrow keys or press **ENTER** to input the value.
3. After inputting the value, press **ENTER** to apply.

## Changing the splash screen

Select splash screen which is the screen with no source is displayed.

1. Select **Menu > Configuration > Menu Preferences > Splash Screen Setup**.
2. Select the appropriate splash screen:
  - Factory Logo
  - Blue
  - Black
  - White
3. Press **ENTER**.

## Setting time out for on-screen display

Adjust the time for on-screen display to disappear.

1. Select **Menu > Configuration > Menu Preferences > Menu Time Out**.
2. Select the appropriate time:

- Off
  - 1 Min
  - 3 Min
3. Press **ENTER**.

## Setting up password protection

Protect your projector with a password. Once enabled, you must enter the password before you can project an image. If the projector is powered on with password protection, you must enter the password to use the projector.

1. Select **Menu > Configuration > Menu Preferences > PIN Protect**.
2. Enter a password by number keys.
3. To confirm the password, select **OK**.

## Changing password

Change the current password to a new password.

1. Select **Menu > Configuration > Menu Preferences > Change PIN**.
2. Enter current password by number keys.
3. Select **OK**.
4. Enter new password by number keys.
5. Select **OK**.
6. To confirm the password, enter new password again by number keys.
7. Select **OK**.

## Setting up power mode

Adjust various projector's power settings including the shutdown time, sleep timer, and standby mode.

## Setting the standby mode

Determine which standby mode the projector is in when AC power on.

1. Select **Menu > Configuration > Power Management > Standby Mode**.
2. Select the appropriate mode:
  - **0.5W mode**—Less power consumption (<0.5W) which does not have the ability to monitor the projector over a network cable.
  - **Communication mode**—More power consumption in standby mode which allows you to monitor the projector over a network cable.

3. Press **ENTER**.



Communication mode is the projector's default standby mode. After performing factory reset, manually set the standby mode to 0.5W mode to have less power consumption (<0.5W).

## Setting the AC power

Enable or disable this function to power on the projector directly or not when AC power is on.

1. Select **Menu > Configuration > Power Management > AC Power On**.
2. To swap, press **ENTER**.

## Setting the time for auto shutdown

Set up a time for automatically turns off the projector after no signal is detected for a preset number of minutes. If an active signal is received before the projector powers down, the image is displayed.

1. Select **Menu > Configuration > Power Management > Auto Shutdown**.
2. Select the appropriate time to automatically turn off the projector when no signal exists.
3. To confirm the selection, press **ENTER**.

## Setting the sleep timer

Set up a time for automatically power off the projector, after it has been on for a specified amount of time.

1. Select **Menu > Configuration > Power Management > Sleep Timer**.
2. Select the appropriate time to automatically turn off the projector.
3. To confirm the selection, press **ENTER**.

## Enabling high altitude setting

Enable high altitude mode when altitudes  $\geq$  2000 m. The fan operates at high speed to ensure sufficient air flow for high altitudes; however, the noise level of the projector is increased.

1. Select **Menu > Configuration > High Altitude**.
2. To swap, press **ENTER**.

## Adjusting IR control settings

Choose IR control setting from top, front and HDbaseT.

1. Select **Menu > Configuration > IR Control**.
2. Select to turn on or off IR control from top, front and HDbaseT.
3. To confirm the selection, press **ENTER**.

## Setting 12V trigger

When enabled, the projector screen is automatically raised or lowered when the projector is turned on or off. This function only works when the projector is connected to an electrical projector screen.

1. Select **Menu > Configuration > 12V Trigger**.
2. Select to turn on or off 12V trigger.
3. To confirm the selection, press **ENTER**.

## Setting audio settings

Control audio settings.

1. Select **Menu > Configuration > Audio Settings**.
2. Select to audio mute or adjust the volume.
3. To confirm the selection, press **ENTER**.



# Configuring communications

Define and control how single or multiple projectors are linked with each other and with controlling device.

## Setting network environment

Determine the communication settings such as network setup, serial port information, and so on.

### Adjusting LAN setting

Set up network configuration for wire networking.

1. Select **Menu > Configuration > Communications > LAN**.
2. Set up the appropriate setting:
  - **MAC Address**—Display the network MAC address value.
  - **Network Status**—Connect or disconnect Network status.
  - **LAN Interface**—Choose from RJ-45 or HDBaseT.
  - **DHCP**—Enable or disable the DHCP to automatically get IP address, subnet mask, and so on.
  - **IP Address**—Assign the network IP address.
  - **Subnet Mask**—Assign the network subnet mask.
  - **Default Gateway**—Assign the network default gateway.
  - **Primary DNS**—Assign the primary DNS.
  - **Secondary DNS**—Assign the secondary DNS.
3. To apply the LAN settings, select **Apply**.

## Adjusting WLAN setting

Set up network configuration for wireless networking.

1. Select **Menu > Configuration > Communications > WLAN**.
2. Set up the appropriate setting:
  - **SSID**—Display the SSID of the wireless network.
  - **Enable**—Enable or disable the wireless functionality.
  - **Start IP**—Assign the start IP address of the wireless network.
  - **End IP**—Assign the end IP address of the wireless network.
  - **Subnet Mask**—Assign the subnet mask of the wireless network.
  - **Default Gateway**—Assign the gateway of the wireless network.
3. To apply the WLAN settings, select **Apply**.

## Adjusting network setting

Set up network configuration setting, such as reset back to default.

1. Select **Menu > Configuration > Communications > Network**.
2. Set up the appropriate network setting:
  - **Show Network Message**—Enable or disable to display of the network message.
  - **Reset to Default**—Reset the network configuration setting, including LAN setting and WLAN setting, back to default.
3. To apply the network configuration, press **ENTER**.

## Setting serial port baud rate

Select the serial port and baud rate.

1. Select **Menu > Configuration > Communications > Serial Port Baud rate**.
2. Set up the appropriate baud rate.
3. To confirm the selection, press **ENTER**.

## Enabling serial port echo

Enable or disable to allow the CLI command pass through.

1. Select **Menu > Configuration > Communications > Serial Port Echo**.
2. To swap, press **ENTER**.

## Logging on to the web user interface

Log on to the web user interface by following the steps below.

1. Connect the projector to AC and power it on.
2. When network is available, connect the projector and computer to the same network.
  - a. To check the projector address in a wired network, select **Menu > Configuration > Communications > LAN > IP Address**.
  - b. To check the projector address in a wireless network, select **Menu > Configuration > Communications > WLAN > Default Gateway**.
3. If network is unavailable, connect the projector to the computer with an RJ45 cable.
  - a. Set the Default Gateway and Subnet Mask of the computer to match the projector.
  - b. Set the IP address of the computer to match the first three numbers of the projector.  
For example, if the projector IP address is 192.168.000.100, set the computer IP address to 192.168.000.xxx, where xxx is not 100.
4. Open a web browser and type the projector address in the browser address bar.
5. In the Username field, type the username.  
The default username is admin.
6. In the Password field, type the password.  
The default password is projector serial number.
7. Click **Login**.

## Using the web interface

To control the projector through the web interface, do the following:

1. Start up the web browser on your computer or mobile devices.
2. Enter the IP address set on the projector into the URL of the web browser.
3. Enter the user name and password to login. After a successful login, you can control the projector over the web interface.

## Using the RS-232C interface

To control the projector through the RS-232C interface, do the following:

1. Connect your computer and the projector directly using the RS-232 cable.
2. Set the same baud rate in both your computer and projector. Use commands to control the projector.

## Re-connecting the network

After the network is disconnected and timeout via RJ-45/HDBaseT/Wifi, the browser will refresh the page automatically and show "HTTP404 (Not Found)" error message.

If user wants to re-control the projector, user must login in the control page with account and password again.

## Adjusting the back light settings

Control the back light behavior and timeout setting for the keypad and status LED.

1. Select **Menu > Configuration > Backlight Preferences > Status LED**.
2. Select the appropriate setting for status LED.
3. To confirm the selection, press **ENTER**.

## Setting the hot key

To directly call out a function without going through the layers of the on-screen display (OSD) menus, select a specific function for a hot key. User can call this function by pressing the HOT KEY on remote control.

1. Select **Menu > Configuration > Hot-Key Settings**.
2. Select the one function for the hot key:
  - Size Presets
  - Picture Settings
  - Default Value
  - Detail
  - Contrast Enhancement
  - Light Source Mode
  - Image Freeze
  - Information
  - Disable Warp/Blend
  - Audio Mute
  - Audio Volume

## Configuring date and time

Configure date and time settings.

## Setting the clock mode

Configure the clock mode.

1. Select **Menu > Configuration > Date and Time > Clock mode**.
2. Select the preferred way:
  - Use NTP Server
  - Manual
3. To confirm the selection, press **ENTER**.

## Setting the date

Configure the date settings.

1. Select **Menu > Configuration > Date and Time > Date**.
2. Setup year, month and day.
3. To confirm, press **ENTER**.

## Setting the time

Configure the time settings.

1. Select **Menu > Configuration > Date and Time > Time**.
2. Setup hour and minute.
3. To confirm, press **ENTER**.

## Setting the daylight saving time

Configure the daylight saving time.

1. Select **Menu > Configuration > Date and Time > Daylight Saving Time**.
2. Select on or off.
3. To confirm, press **ENTER**.

## Setting the NTP server

Configure the NTP server settings.

1. Select **Menu > Configuration > Date and Time > NTP Server**.
2. Select the preferred NTP server:
  - time.google.com
  - asia.pool.ntp.org
  - europe.pool.ntp.org
  - north-america.pool.ntp.org

3. To confirm, press **ENTER**.

## Setting the time zone

Select the time zone.

1. Select **Menu > Configuration > Date and Time > Time Zone**.
2. Select time zone.
3. To confirm, press **ENTER**.

## Setting the update interval for date and time

Set the update interval.

1. Select **Menu > Configuration > Date and Time > Update Interval**.
2. Select either hourly or daily.
3. To confirm, press **ENTER**.

## Applying the date and time settings

To apply the date and time settings, do the following.

1. Select **Menu > Configuration > Date and Time > Apply**.
2. Press **ENTER**.

## Set event schedules

Schedule power settings, input source, light source mode, and shutter.

## Setting the date and time schedule

Check or adjust the date and time for the projector.

1. Select **Menu > Configuration > Schedule > Date and Time**.
2. Setup YYYY/MM/DD MM:SS.
3. To confirm, press **ENTER**.

## Setting the schedule mode

Enable or disable the schedule function. If the projector is controlled using external devices or software, the Schedule Mode displays AP Mode and the projector's schedule functions are grayed out.

1. Select **Menu > Configuration > Schedule > Schedule Mode**.
2. Select on or off.

3. To confirm, press **ENTER**.

## Viewing the event list for the day

View the event list scheduled for today.

1. Select **Menu > Configuration > Schedule > View Today**.
2. Press **ENTER**.

## Setting the weekly schedule

Set up the schedule for the days of a week. On the Schedule menu page, select a day and configure the schedule settings.

1. Select **Menu > Configuration > Schedule > Monday to Sunday**.
2. Press **ENTER**.

## Resetting the schedule

Reset all of the schedule settings.

1. Select **Menu > Configuration > Schedule > Reset schedule**.
2. Press **ENTER**.

# Configuring light source

Learn how to configure the light settings.

## Setting light source

Set up the light source to control the projector brightness.

1. Select **Menu > Light Source > Light Source Mode**.
2. Set up the appropriate light source model:
  - **Constant Power**—Enable Constant Power to set the projector brightness to a specific level controlled by the laser diode power. See [Setting constant power](#) on page 57 for more details of setting the laser diode power.
  - **Constant Intensity**—After enabling Constant Power, select Constant Intensity to maintain current constant brightness and color settings. This function can remain at the current setting for longer period of time than Constant Power mode.
    - Light sensor calibration must be performed before enabling Constant Intensity and is used for long-term projecting or blending purposes.
    - When Constant Intensity is enabled, Dynamic Black and Real Black functions are automatically disabled.
    - When Picture Settings is changed under Constant Intensity, the light source mode automatically changes to Constant Power.
  - **ECO 1 (80%)**—Set the projector to 80% constant brightness and color settings.
  - **ECO 2 (50%)**—Set the projector to 50% constant brightness and color settings.
3. Press **ENTER**.





## Setting constant power

Set the value of the laser diode power. The power levels can be managed to obtain the brightest picture or longest light source life. The minimum setting of the light power is 30% brightness and color setting, and the maximum is 100% brightness and color setting.

1. Select **Menu > Light Source > Constant Power**.
2. Adjust the slider from 1 to 100 by arrow keys or press **ENTER** to input the value you selected.
3. After inputting the value, press **ENTER** to apply.

# Projector information

View the projector related information, set a test pattern, and change the language.

## Viewing projector information

View the projector information about its status and settings. The projector information is read only.

1. Select **Menu > Information**.
2. Select the information category.
3. Press **ENTER**.

## Changing the language

Choose the language you want displayed on projector display panel and on-screen display.

1. Select **Menu > Language**.
2. Select the appropriate language.
3. Press **ENTER**.

## Selecting a test pattern

Use the projector's test patterns to assist with configuration of the projector and to diagnose any issues that may occur.

1. Select Test Pattern on remote control.  
You can also select the test patterns from **Menu > Test Pattern**.
2. Scroll through the list of test patterns by left and right arrow keys on remote control.
3. Select the required test pattern.
4. To confirm your selection, press **ENTER**.

# Configuring input settings

Learn how to configure the input source and picture-in-picture (PIP)/picture-by-picture (PBP) settings.

## Setting the main input source

Set up the active input to be used as the main image.

1. Select **Menu > Input Switching & PIP > Main Input**.
2. To select the active input, press **ENTER**.

## Setting the second input source

Select an active input to be used as the picture-in-picture (PIP)/picture-by-picture (PBP).

1. Select **Menu > Input Switching & PIP > PIP/PBP Input**.
2. To select another active input, press **ENTER**.

## Enabling the second input source

To activate the picture-in-picture (PIP)/picture-by-picture (PBP) setting, switch on this function.

1. Select **Menu > Input Switching & PIP > PIP/PBP Enable**.
2. To swap, press **ENTER**.

## Swapping the main input and second input source

Switch the main input source with second input source.

1. Select **Menu > Input Switching & PIP > Swap**.
2. To swap, press **ENTER**.

## Setting the size of second input source

Set the size of picture-in-picture (PIP)/picture-by-picture (PBP). See [Input sources layout and size](#) on page 61 for more details of the layout and size.

1. Select **Menu > Input Switching & PIP > Size**.
2. Select the appropriate size, small, medium or large, for PIP/PBP input source.
3. To confirm the selection, press **ENTER**.

## Setting the display layout with two input sources







Set the display location for main input source and second input source on the screen. See [Input sources layout and size](#) on page 61 for more details of the layout and size.

1. Select **Menu > Input Switching & PIP > Layout**.
2. Select the appropriate layout.
3. To confirm the selection, press **ENTER**.

## Input sources layout and size

A P indicates the primary source region (lighter color) and an asterisk (\*) indicates both regions are the same size.

PIP/PBP Layout	PIP/PBP Size		
	Small	Medium	Large
PBP, Main Left			*
PBP, Main Top			*
PBP, Main Right			*
PBP, Main Bottom			*
PIP, Sub Bottom Right			
PIP, Sub Bottom Left			

PIP/PBP Layout	PIP/PBP Size		
	Small	Medium	Large
PIP, Sub Top Left			
PIP, Sub Top Right			

## Setting the timing detection mode

Set timing detection mode to enhanced or normal to support additional PC timings. When the projected picture is not completed, this function is used to adjust the picture.

1. Select **Menu > Input Switching & PIP > Auto Image Resync**.
2. Select the appropriate mode:
  - **Normal**—If the input signal source has been plugged to the same port on the projector and not been replugged, then the projector can process the signal at a faster speed.
  - **Enhanced**—Every time the projector receives the signal, it will analyze the source signal profoundly and verify the integrity. This ensures the optimal image quality but consumes more time.
3. To confirm the selection, press **ENTER**.

## Setting the input searching method

Set the most suited method for searching input source.

1. Select **Menu > Input Switching & PIP > Input key**.
2. Select the appropriate searching method:
  - **Change Sources**—Change the source manually by pressing **INPUT** on the keypad or remote control.
  - **List all Sources**—Select to list all the sources and then select the input source you want.
  - **Auto Sources**—Automatically search the source.
3. To confirm the selection, press **ENTER**.

## Adjusting the sub image

Adjust the image related settings for the sub source in PIP mode.

1. Select **Menu > Input Switching & PIP > Adjust Sub Image**.
2. Set up the appropriate setting for sub source:
  - **Brightness**—Adjust the brightness of the sub image to adapt to various ambient light.
  - **Contrast**—Adjust the contrast ratio of the sub image.
  - **Color Space**—Select a color space for the sub image.

## Enabling low latency mode

Enable the Low Latency Mode to minimize the input lag. This function is used for live broadcasting, streaming media, and similar installations.

1. Select **Menu > Input Switching & PIP > Low Latency Mode**.
2. Select the appropriate mode.
  - **Normal**—No functional restrictions but longer delay time.
  - **2D Ultra**—Reduces latency in 2D mode but sets restrictions when warping the image.



2D Ultra does not support 3D, 4K timing, input timings outside the range of 30fps to 120fps, PIP/PBP mode, and image freeze.

3. To confirm the selection, press **ENTER**.

## Configuring the HDMI setting

Enable or disable the Extended Display Identification Data (EDID) for HDMI 2.0 to play videos from hardware devices, such as DVD players.

The most commonly used HDMI versions are HDMI 1.4 and 2.0, with differences in bandwidth. The projector is compatible with both HDMI 1.4 and HDMI 2.0. When the projector is connected to a hardware device supporting HDMI 1.4 only, disable the EDID for HDMI 2.0 to play the videos properly.

1. Select **Menu > Input Switching & PIP > EDID**.
2. Select the HDMI version.
3. To confirm the setting, press **ENTER**.



HDMI 2.0 is supported only by HDMI1 connector.

## Configuring the HDMI output

Set the default HDMI output port.

1. Select **Menu > Input Switching & PIP > HDMI Output**.
2. Select **HDMI 1** or **HDMI 2** as the HDMI output.
3. To confirm the setting, press **ENTER**.



# Signal connectivity specifications

Identify the signal connectivity specifications for Inspire Series projector.

The list of formats listed below are not exhaustive and other formats may be supported. For more information, contact Christie Technical Support.

## VGA video formats

Identify the video formats for the VGA input.

Signal Type	Signal Format	Resolution	Aspect Ratio		V Sync (Hz)	RGB	YPbPr
PC	VGA	640 x 350			85	V	X
		640 x 400		16:10	85	V	X
		640 x 480	1.33	4:3	60	V	X
					72	V	X
					75	V	X
					85	V	X
		720 x 400	1.8	9:5	70	V	X
					85	V	X
		SVGA	800 x 600	1.33	4:3	60	V
	72					V	X
	75					V	X
	85					V	X
	75					V	X
	832 x 624				75	V	X
	848 x 480			60	V	X	
XGA	1024 x 768	1.33	4:3	60	V	X	
				70	V	X	

Signal Type	Signal Format	Resolution	Aspect Ratio		V Sync (Hz)	RGB	YPbPr
PC	XGA	1024 x 768	1.33	4:3	75	V	X
					85	V	X
	SXGA	1152 x 864	1.32		75	V	X
		1152 x 870			75	V	X
	WXGA	1280 x 768	1.67	5:3	60	V	X
					75	V	X
					85	V	X
		1280 x 800	1.6	16:10	60	V	X
					75	V	X
					85	V	X
	SXGA	1280 x 960	1.33	4:3	60	V	X
					85	V	X
		1280 x 1024	1.25	5:4	60	V	X
					75	V	X
	WXGA	1360 x 768	1.78	16:9	60	V	X
		1366 x 768				V	X
	SXGA+	1400 x 1050	1.33	4:3		V	X
	WXGA+	1440 x 900	1.6	16:10	60	V	X
					75	V	X
	WXGA++	1600 x 900	1.78	16:9	60	V	X
UXGA	1600 x 1200	1.33	4:3	50	V	X	
				60	V	X	
WSXGA+	1680 x 1050	1.6	16:10		V	X	
WUXGA RB	1920 x 1200RB			50	V	X	
				60	V	X	
TV	SDTV (480i)	720 x 480	1.5	3:2	59.94	V	V
					60	V	V
	SDTV (576i)	720 x 576	1.25	5:4	50	V	V
	EDTV (480p)	720 x 480	1.5	3:2	59.94	V	V
					60	V	V
	EDTV (576p)	720 x 576	1.25	5:4	50	V	V

Signal Type	Signal Format	Resolution	Aspect Ratio		V Sync (Hz)	RGB	YPbPr
TV	HDTV (1080i)	1920 x 1080	1.78	16:9	50	V	V
					59.94	V	V
					60	V	V
	HDTV (720p)	1280 x 720	1.78	16:9	50	V	V
					59.94	V	V
					60	V	V
	HDTV (1080p)	1920 x 1080	1.78	16:9	23.98	V	V
					24	V	V
					25	V	V
					29.97	V	V
					30	V	V
					50	V	V
					59.94	V	V
					60	V	V

(V): Video format is supported.

(X): Video format is Not supported.

# HDMI video formats

Identify the video formats for the HDMI input.

Signal Type	Signal Format	Resolution	Aspect Ratio		V Sync (Hz)	RGB			YCbCr 4:4:4			YCbCr 4:2:2	
						8 bit	10 bit	12 bit	8 bit	10 bit	12 bit	8 bit	
PC	VGA	640 x 350			85	V	V	V	V	V	V	V	
		640 x 400		16:10	85	V	V	V	V	V	V	V	
		640 x 480	1.33	4:3	60	V	V	V	V	V	V	V	V
					72	V	V	V	V	V	V	V	
					75	V	V	V	V	V	V	V	
					85	V	V	V	V	V	V	V	
		720 x 400	1.8	9:5	70	V	V	V	V	V	V	V	
					85	V	V	V	V	V	V	V	
		SVGA	800 x 600	1.33	4:3	60	V	V	V	V	V	V	V
						72	V	V	V	V	V	V	V
	75					V	V	V	V	V	V	V	
	85					V	V	V	V	V	V	V	
	120					V	V	V	V	V	V	V	
	832 x 624				75	V	V	V	V	V	V		
	848 x 480			60	V	V	V	V	V	V			
	XGA	1024 x 768	1.33	4:3	60	V	V	V	V	V	V	V	
					70	V	V	V	V	V	V	V	
					75	V	V	V	V	V	V	V	
					85	V	V	V	V	V	V	V	
					120	V	V	V	V	V	V	V	
	SXGA	1152 x 864			75	V	V	V	V	V	V		
		1152 x 870	1.32		75	V	V	V	V	V	V		
	WXGA	1280 x 768	1.67	5:3	60	V	V	V	V	V	V	V	
					75	V	V	V	V	V	V	V	
					85	V	V	V	V	V	V	V	
		1280 x 800	1.6	16:10	60	V	V	V	V	V	V	V	
					75	V	V	V	V	V	V	V	
					85	V	V	V	V	V	V	V	
				120	V	V	V	V	V	V			

Signal Type	Signal Format	Resolution	Aspect Ratio		V Sync (Hz)	RGB			YCbCr 4:4:4			YCbCr 4:2:2
						8 bit	10 bit	12 bit	8 bit	10 bit	12 bit	8 bit
PC	SXGA	1280 x 960	1.33	4:3	60	V	V	V	V	V	V	V
					85	V	V	V	V	V	V	V
		1280 x 1024	1.25	5:4	60	V	V	V	V	V	V	V
					75	V	V	V	V	V	V	V
	WXGA	1360 x 768	1.78	16:9	60	V	V	V	V	V	V	V
						1366 x 768	V	V	V	V	V	V
	SXGA+	1400 x 1050	1.33	4:3		V	V	V	V	V	V	V
	WXGA+	1440 x 900	1.6	16:10	60	V	V	V	V	V	V	V
					75	V	V	V	V	V	V	V
					85	V	V	V	V	V	V	V
	WXGA++	1600 x 900	1.78	16:9	60	V	V	V	V	V	V	V
	UXGA	1600 x 1200	1.33	4:3	50	V	V	V	V	V	V	V
					60	V	V	V	V	V	V	V
	WSXGA+	1680 x 1050	1.6	16:10		V	V	V	V	V	V	V
	WUXGA RB	1920 x 1200RB			50	V	V	V	V	V	V	V
			60	V	V	V	V	V	V	V		
TV	SDTV (480i)	720 x 480	1.5	3:2	59.94	V	V	V	V	V	V	V
					60	V	V	V	V	V	V	V
	SDTV (576i)	720 x 576	1.25	5:4	50	V	V	V	V	V	V	V
	EDTV (480p)	720 x 480	1.5	3:2	59.94	V	V	V	V	V	V	V
					60	V	V	V	V	V	V	V
	EDTV (576p)	720 x 576	1.25	5:4	50	V	V	V	V	V	V	V
	HDTV (1080i)	1920 x 1080	1.78	16:9	50	V	V	V	V	V	V	V
					59.94	V	V	V	V	V	V	V
					60	V	V	V	V	V	V	V
	HDTV (720p)	1280 x 720	1.78	16:9	50	V	V	V	V	V	V	V
					59.94	V	V	V	V	V	V	V
					60	V	V	V	V	V	V	V
					120	V	V	V	V	V	V	V
	HDTV (1080p)	1920 x 1080	1.78	16:9	23.98	V	V	V	V	V	V	V
					24	V	V	V	V	V	V	V
					25	V	V	V	V	V	V	V
29.97					V	V	V	V	V	V	V	

Signal Type	Signal Format	Resolution	Aspect Ratio		V Sync (Hz)	RGB			YCbCr 4:4:4			YCbCr 4:2:2	
						8 bit	10 bit	12 bit	8 bit	10 bit	12 bit	8 bit	
TV	HDTV (1080p)	1920 x 1080	1.78	16:9	30	V	V	V	V	V	V	V	
					50	V	V	V	V	V	V	V	
					59.94	V	V	V	V	V	V	V	
					60	V	V	V	V	V	V	V	
	Mandatory 3D	Frame Packing (1080p)	1920 x 1080	1.78	16:9	23.98	V	V	V	V	V	V	V
						24	V	V	V	V	V	V	V
		Frame Packing (720p)	1280 x 720	1.78	16:9	50	V	V	V	V	V	V	V
						59.94	V	V	V	V	V	V	V
						60	V	V	V	V	V	V	V
		Side by Side (1080i)	1920 x 1080	1.78	16:9	50	V	V	V	V	V	V	V
59.94						V	V	V	V	V	V	V	
60						V	V	V	V	V	V	V	
Top and Bottom (720p)		1280 x 720	1.78	16:9	50	V	V	V	V	V	V	V	
					59.94	V	V	V	V	V	V	V	
	60				V	V	V	V	V	V	V		
Top and Bottom (1080p)	1920 x 1080	1.78	16:9	23.98	V	V	V	V	V	V	V		
				24	V	V	V	V	V	V	V		
Frame Sequential 3D	SVGA	800 x 600	1.33	4:3	120	V	V	V	V	V	V	V	
	XGA	1024 x 720				V	V	V	V	V	V	V	
	HDTV	1280 x 720	1.78	16:9	60	V	V	V	V	V	V	V	
	WXGA	1280 x 800	1.60	16:10		V	V	V	V	V	V		
	1080p	1920 x 1080	1.78	16:9		V	V	V	V	V	V	V	
	WUXGA	1920 x 1200	1.60	16:10		V	V	V	V	V	V	V	
4K(*)	3840 x 2160	3840 x 2160	1.78	16:9	24	V	V	V	V	V	V	V	
					25	V	V	V	V	V	V	V	
					30	V	V	V	V	V	V	V	
					50	V	X	X	V	X	X	V	
					60	V	X	X	V	X	X	V	
	4096 x 2160 SMPTE	4096 x 2160	1.90	16:9	24	V	V	V	V	V	V	V	
					25	V	V	V	V	V	V	V	
					30	V	V	V	V	V	V	V	
					50	V	X	X	V	X	X	V	
					60	V	X	X	V	X	X	V	

(V): Video format is supported.

(X): Video format is Not supported.



- 4K is not supported if the source is HDMI2.

## HDBaseT video formats

Identify the video formats for the HDBaseT input.

Signal Type	Signal Format	Resolution	Aspect Ratio		V Sync (Hz)	RGB			YCbCr 4:4:4			YCbCr 4:2:2	
						8 bit	10 bit	12 bit	8 bit	10 bit	12 bit	8 bit	
PC	VGA	640 x 350			85	V	V	V	V	V	V	V	
		640 x 400		16:10	85	V	V	V	V	V	V	V	
		640 x 480	1.33	4:3	60	V	V	V	V	V	V	V	V
					72	V	V	V	V	V	V	V	
					75	V	V	V	V	V	V	V	
					85	V	V	V	V	V	V	V	
		720 x 400	1.8	9:5	70	V	V	V	V	V	V	V	
					85	V	V	V	V	V	V	V	
		SVGA	800 x 600	1.33	4:3	60	V	V	V	V	V	V	V
	72					V	V	V	V	V	V	V	
	75					V	V	V	V	V	V	V	
	85					V	V	V	V	V	V	V	
	120					V	V	V	V	V	V	V	
	832 x 624				75	V	V	V	V	V	V		
	848 x 480			60	V	V	V	V	V	V			
	XGA	1024 x 768	1.33	4:3	60	V	V	V	V	V	V	V	
					70	V	V	V	V	V	V	V	
					75	V	V	V	V	V	V	V	
					85	V	V	V	V	V	V	V	
					120	V	V	V	V	V	V	V	
	SXGA	1152 x 864			75	V	V	V	V	V	V		
1152 x 870		1.32		75	V	V	V	V	V	V			

Signal Type	Signal Format	Resolution	Aspect Ratio		V Sync (Hz)	RGB			YCbCr 4:4:4			YCbCr 4:2:2	
						8 bit	10 bit	12 bit	8 bit	10 bit	12 bit	8 bit	
PC	WXGA	1280 x 768	1.67	5:3	60	V	V	V	V	V	V	V	V
					75	V	V	V	V	V	V	V	V
					85	V	V	V	V	V	V	V	V
		1280 x 800	1.6	16:10	60	V	V	V	V	V	V	V	V
					75	V	V	V	V	V	V	V	V
					85	V	V	V	V	V	V	V	V
	120				V	V	V	V	V	V	V	V	
	SXGA	1280 x 960	1.33	4:3	60	V	V	V	V	V	V	V	V
					85	V	V	V	V	V	V	V	V
		1280 x 1024	1.25	5:4	60	V	V	V	V	V	V	V	V
					75	V	V	V	V	V	V	V	V
					85	V	V	V	V	V	X	V	V
	WXGA	1360 x 768	1.78	16:9	60	V	V	V	V	V	V	V	V
		1366 x 768				V	V	V	V	V	V	V	V
	SXGA+	1400 x 1050	1.33	4:3		V	V	V	V	V	V	V	V
	WXGA+	1440 x 900	1.6	16:10	60	V	V	V	V	V	V	V	V
					75	V	V	V	V	V	V	V	V
					85	V	V	V	V	V	V	V	V
	WXGA++	1600 x 900	1.78	16:9	60	S	V	V	V	V	V	V	V
	UXGA	1600 x 1200	1.33	4:3	50	V	V	V	V	V	V	V	V
60					V	V	V	V	V	X	V	V	
WSXGA+	1680 x 1050	1.6	16:10		V	V	V	V	V	V	V	V	
WUXGA RB	1920 x 1200RB			50	V	V	V	V	V	V	V	V	
					60	V	V	V	V	V	X	V	
TV	SDTV (480i)	720 x 480	1.5	3:2	59.94	V	V	V	V	V	V	V	V
					60	V	V	V	V	V	V	V	V
	SDTV (576i)	720 x 576	1.25	5:4	50	V	V	V	V	V	V	V	
	EDTV (480p)	720 x 480	1.5	3:2	59.94	V	V	V	V	V	V	V	V
					60	V	V	V	V	V	V	V	V
	EDTV (576p)	720 x 576	1.25	5:4	50	V	V	V	V	V	V	V	
	HDTV (1080i)	1920 x 1080	1.78	16:9	50	V	V	V	V	V	V	V	V
					59.94	V	V	V	V	V	V	V	V
					60	V	V	V	V	V	V	V	V



Signal Type	Signal Format	Resolution	Aspect Ratio		V Sync (Hz)	RGB			YCbCr 4:4:4			YCbCr 4:2:2
						8 bit	10 bit	12 bit	8 bit	10 bit	12 bit	8 bit
TV	HDTV (720p)	1280 x 720	1.78	16:9	50	V	V	V	V	V	V	V
					59.94	V	V	V	V	V	V	V
					60	V	V	V	V	V	V	V
					120	V	V	V	V	V	V	V
	HDTV (1080p)	1920 x 1080	1.78	16:9	23.98	V	V	V	V	V	V	V
					24	V	V	V	V	V	V	V
					25	V	V	V	V	V	V	V
					29.97	V	V	V	V	V	V	V
					30	V	V	V	V	V	V	V
					50	V	V	V	V	V	V	V
					59.94	V	V	V	V	V	V	V
					60	V	V	V	V	V	V	V
Mandatory 3D	Frame Packing (1080p)	1920 x 1080	1.78	16:9	23.98	V	V	V	V	V	V	V
					24	V	V	V	V	V	V	V
	Frame Packing (720p)	1280 x 720	1.78	16:9	50	V	V	V	V	V	V	V
					59.94	V	V	V	V	V	V	V
					60	V	V	V	V	V	V	V
	Side by Side (1080i)	1920 x 1080	1.78	16:9	50	V	V	V	V	V	V	V
					59.94	V	V	V	V	V	V	V
					60	V	V	V	V	V	V	V
	Top and Bottom (720p)	1280 x 720	1.78	16:9	50	V	V	V	V	V	V	V
					59.94	V	V	V	V	V	V	V
					60	V	V	V	V	V	V	V
	Top and Bottom (1080p)	1920 x 1080	1.78	16:9	23.98	V	V	V	V	V	V	V
24					V	V	V	V	V	V	V	
Frame Sequential 3D	SVGA	800 x 600	1.33	4:3	120	V	V	V	V	V	V	V
	XGA	1024 x 720	1.33	4:3		V	V	V	V	V	V	V
	HDTV	1280 x 720	1.78	16:9		V	V	V	V	V	V	V
	WXGA	1280 x 800	1.60	16:10	V	V	V	V	V	V	V	
	1080p	1920 x 1080	1.78	16:9	60	V	V	V	V	V	V	V
	WUXGA	1920 x 1200	1.60	16:10		V	V	V	V	V	V	V

## Picture-in-picture/picture-by-picture (PIP/PBP) compatibility

The following table details the picture-in-picture/picture-by-picture (PIP/PBP) compatibility.

PIP/PBP		VGA	HDMI2	HDMI1		HDBaseT
			HDMI 1.4	HDMI 1.4	HDMI 2.0	
Sub Source	VGA		•	•	•	•
	HDMI2	HDMI 1.4	•	•	•	•
	HDMI1	HDMI 1.4	•	•		•
		HDMI 2.0	•	•		•
	HDBaseT		•	•	•	

- Dot (•): PIP/PBP combinations are enabled.

# Regulatory

This product conforms to the following regulations related to product safety, environmental requirements and electromagnetic compatibility (EMC).

## Safety

- CAN/CSA C22.2 No. 60950-1-07 - Information Technology Equipment – Safety – Part 1: General Requirements
- ANSI/UL 60950-1-2014 – Information Technology Equipment – Safety – Part 1: General Requirements
- IEC/EN 60950-1 – Information Technology Equipment – Safety – Part 1: General Requirements

## Laser safety

- IEC 60825-1:2014 – Safety of Laser Products – Part 1: Equipment Classification and Requirements
- IEC 62471:2006 – Photobiological safety of lamps and lamp systems
- IEC 62471-5:2015 – Photobiological safety of lamps and lamp systems – Part 5: Image projectors
- FDA 2015-02 – Immediately in Effect Guidance Document: Classification and Requirements for Laser Illuminated Projectors (LIPs)

## Electro-magnetic compatibility

### Emissions

- FCC CFR47, Part 15, Subpart B/ANSI C63.4, Class A - Unintentional Radiators
- CAN ICES-3 (A/B) / NMB-3 (A)
- CISPR 32:2014/EN 55032:2014, Class A - Information Technology
- IEC 61000-3-2/EN61000-3-2 - Limits for Harmonic Current Emissions
- IEC 61000-3-3/EN61000-3-3 - Limitations of Voltage Changes, Voltage Fluctuations, and Flicker

## Immunity

- CISPR 24: 2010/EN55024:2010 - EMC Requirements - Information Technology Equipment

## Environmental

- EU Directive (2011/65/EU) on the restriction of the uses of certain hazardous substances (RoHS) in electrical and electronic equipment and the applicable official amendment(s)
- EU Directive (2012/19/EU) on waste and electrical and electronic equipment (WEEE) and the applicable official amendment(s)
- Regulation (EC) No 1907/2006 concerning the Registration, Evaluation, Authorisation and Restriction of Chemicals (REACH) and the applicable official amendment(s)
- China Ministry of Information Industry Order No.39 (02/2006) on the control of pollution caused by electronic information products, hazardous substances concentration limits (SJ/T11363-2006), and the applicable product marking requirement (SJ/T11364-2006)

## FCC

This device complies with Part 15 of the FCC rules. Operation is subject to the following two conditions:

- (1) This device may not cause harmful interference,
- (2) This device must accept any interference received; including interference that may cause undesired operation.

This Equipment has been tested and found to comply with the limits for a Class A digital device, pursuant to part 15 of the FCC Rules. These limits are designed to provide reasonable protection against harmful interference when the equipment is operated in a commercial environment. This equipment generates, uses, and can radiate radio frequency energy and, if not installed and used in accordance with the instruction manual, may cause harmful interference to radio communications.

Operation of this equipment in a residential area is likely to cause harmful interference in which case the user will be required to correct the interference at his own expense.

## IEC

The Class A digital apparatus meets all requirements of the Canadian Interference-Causing Equipment Regulation. Interference-Causing Equipment Regulation.

Cet appareil numérique de la class A respecte toutes les exigences du Règlement sur le matériel brouilleur du Canada.

## CE

This product is herewith confirmed to comply with the requirements set out in the Council Directives on the Approximation of the laws of the Member States relating to Electromagnetic Compatibility Directive 2004/108/EEC.

**Warning!**

- This product must not be used in residential areas.
- This product may cause interference if used in residential areas.

Such use must be avoided unless the user takes special measures to reduce electromagnetic emissions to prevent interference to the reception of radio and television broadcasts.

## Declaration of Conformity for EU countries

- EMC Directive 2014/30/EU (including amendments)
- Low Voltage Directive 2014/35/EU
- (RED) 2014/53/EU (if product has RF function)

## WEEE

This product is herewith confirmed to comply with the requirements set out in the Council Directives on the Approximation of the laws of the Member States relating to Electromagnetic Compatibility Directive 2004/108/EEC.

**Disposal instructions**

Do not throw this electronic device into the trash when discarding.

To minimize pollution and ensure utmost protection of the global environment, recycle it.

