

**Canon**

**MULTIMEDIA PROJECTOR  
LV-WX300UST**

**LV-WX300USTi**

**User's Manual**

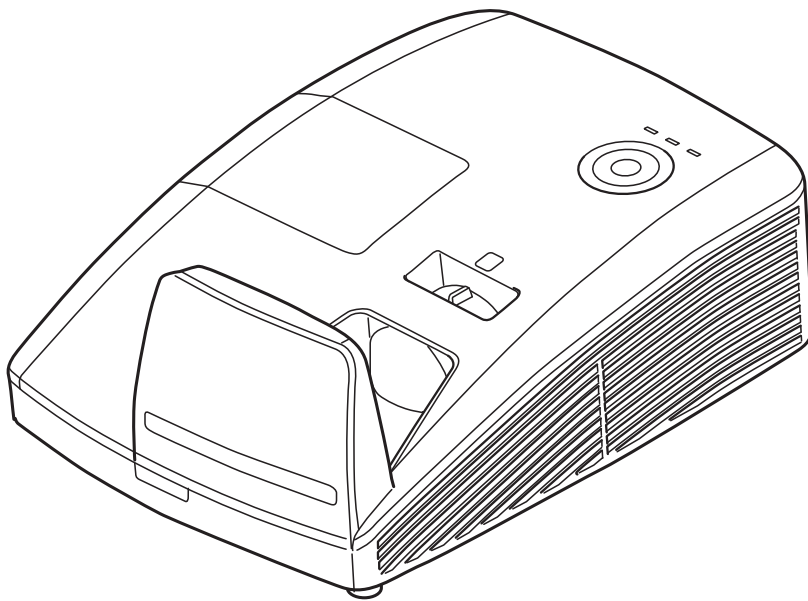

**HDMI™**  
HIGH DEFINITION MULTIMEDIA INTERFACE

## Copyright

This publication, including all photographs, illustrations and software, is protected under international copyright laws, with all rights reserved. Neither this manual, nor any of the material contained herein, may be reproduced without written consent of the author.

© Copyright 2015

## Disclaimer

The information in this document is subject to change without notice. The manufacturer makes no representations or warranties with respect to the contents hereof and specifically disclaims any implied warranties of merchantability or fitness for any particular purpose. The manufacturer reserves the right to revise this publication and to make changes from time to time in the content hereof without obligation of the manufacturer to notify any person of such revision or changes.

## Trademark Recognition



Kensington is a U.S. registered trademark of ACCO Brand Corporation with issued registrations and pending applications in other countries throughout the world.



HDMI, the HDMI Logo, and High-Definition Multimedia Interface are trademarks or registered trademarks of HDMI Licensing LLC in the United States and other countries.

All other product names used in this manual are the properties of their respective owners and are acknowledged.

## Copyright Notice

Please note that enlarging or reducing the size of an image for commercial purposes or public presentation may infringe on the legally protected copyright or the copyright holder of the original material.

## About Trademarks

- Ethernet is a registered trademark of Xerox Corporation.
- Microsoft, Windows, Windows Vista, Windows 7, Windows 8 and Aero are registered trademarks or trademarks of Microsoft Corporation in the United States and / or other countries.
- Mac, Mac OS and Macintosh are trademarks of Apple Inc., registered in the United States and / or other countries.
- HDMI, the HDMI logo and High-Definition Multimedia Interface are trademarks or registered trademarks of HDMI Licensing, LLC.
- PLink is a registered trademark, or an application has been submitted for trademark, in Japan, the United States and / or other countries or regions.
- AMX is a trademark of AMX Corporation.
- Crestron®, Crestron RoomView®, and Crestron Connected

## **Projector Installation Notice**

- Place the projector in a horizontal position  
**The tilt angle of the projector should not exceed 15 degrees**, nor should the projector be installed in any way other than the desktop and ceiling mount, otherwise lamp life could decrease dramatically, and may lead to other **unpredictable damages**.
- Allow at least 50 cm clearance around the exhaust vent.
- Ensure that the intake vents do not recycle hot air from the exhaust vent.
- When operating the projector in an enclosed space, ensure that the surrounding air temperature within the enclosure does not exceed operation temperature while the projector is running, and the air intake and exhaust vents are unobstructed.

## **Verify Installation Location**

- Turn on Altitude Mode when located in high altitude areas
- The projector can only be installed upright or inverted.
- When installation the bracket, make sure the weight limit is not exceed and firmly secured.
- Avoid installing at high temperature, insufficient cooling and heavy dust locations.
- Keep your product away from fluorescent lamps to avoid malfunction caused by IR interference.
- The VGA IN connector should be connected to the VGA IN port. Note that it should be inserted tightly, with the screws on both sides securely fastened to ensure proper connection of the signal wire for achieving optimal display effect.
- The AUDIO IN connector should be connected to the AUDIO IN port and CANNOT be connected to AUDIO OUT or other ports like BNC, RCA; otherwise, it will lead to mute output and even DAMAGE the port.
- The power cord and signal cable should be connected before power on the projector. During the projector starting and operating process, DO NOT insert or remove the signal cable or the power cord to avoid damaging the projector.

## **Cooling notes**

### **Air outlet**

- Make sure the air outlet is 50cm clear of any obstruction to ensure proper cooling.
- Air outlet location should not be in front of the lens of other projector to avoid causing illusions.
- Keep the outlet at least 100cm away from the inlets of other projectors
- The projector generates a massive amount of heat during use. The internal fan dissipates the heat of the projector when shutting down, and such process may continue for a certain period. After the project enters STANDBY MODE status, press the AC power button to turn off the projector and remove the power cord. DO NOT remove the power cord during the shutdown process, as it may cause damage to the projector. In the meantime, the delayed heat radiating will also affect the service life of the projector. The shutdown process may vary depending on the model used. Whatever the case may be, be sure to disconnect the power cord till after the projector enters the STANDBY status.

### **Air inlet**

- Make sure there is no object blocking air input within 30 cm.
- Keep the inlet away from other heat sources
- Avoided heavy dust area

## Power Safety

- Only use the supplied power cord.
- Do not place anything on the power cord. Place the power cord where it will not be in the way of foot traffic.
- Remove the batteries from the remote control when storing or not in use for a prolonged period.

## Replacing the Lamp

Replacing the lamp can be hazardous if done incorrectly. See [Replacing the Projection Lamp](#) on page 52 for clear and safe instructions for this procedure. Before replacing the lamp:

- Unplug the power cord.
- Allow the lamp to cool for about one hour.



### **Warnings:**

*Precautions when replacing lamps that stop working*

- *If illumination suddenly stops, either when you turn the projector on or after it has been on for a while, the lamp may have ruptured. In this case, never attempt to replace the lamp by yourself. Always request service from the Canon Customer Support Center. Additionally, with ceiling-mounted projectors, the lamp may fall out when you open the lamp cover or while you are attempting to replace it.*
- *During replacement, stand to the side of the lamp cover, not directly under it. If the lamp ruptures and you accidentally inhale or get pieces in your eyes or mouth, consult a doctor immediately.*
- *If the lamp ruptures, dust and gas (containing mercury vapor) may come out of the exhaust vents. If this happens, immediately open the windows and doors to provide ventilation to the room. If you inhale any gas emitted from the lamp or it has come into contact with your eyes or mouth, consult a doctor immediately.*

## About this manual

This manual is intended for end users and describes how to install and operate the DLP projector. Wherever possible, relevant information—such as an illustration and its description—has been kept on one page. This printer-friendly format is both for your convenience and to help save paper, thereby protecting the environment. It is suggested that you only print sections that are relevant to your needs.

# Table of Contents

|  |           |
|--|-----------|
| <b>SAFETY INSTRUCTIONS</b> .....                               | <b>1</b>  |
| <b>GETTING STARTED</b> .....                                   | <b>11</b> |
| PACKING CHECKLIST .....  | 11        |
| VIEWS OF PROJECTOR PARTS.....                                  | 12        |
| <i>Front-right View</i> .....                                  | 12        |
| <i>Top view—On-screen Display (OSD) buttons and LEDs</i> ..... | 13        |
| <i>Rear view</i> .....   | 14        |
| <i>Bottom view</i> .....                                       | 16        |
| REMOTE CONTROL PARTS .....                                     | 17        |
| REMOTE CONTROL OPERATING RANGE.....                            | 18        |
| PROJECTOR AND REMOTE CONTROL BUTTONS.....                      | 18        |
| <b>SETUP AND OPERATION</b> .....                               | <b>19</b> |
| INSERTING THE REMOTE CONTROL BATTERIES .....                   | 19        |
| STARTING AND SHUTTING DOWN THE PROJECTOR.....                  | 20        |
| SETTING AN ACCESS PASSWORD (SECURITY LOCK) .....               | 21        |
| ADJUSTING THE PROJECTOR LEVEL .....                            | 23        |
| ADJUSTING THE FOCUS AND KEYSTONE .....                         | 24        |
| ADJUSTING THE VOLUME .....                                     | 24        |
| <b>ON-SCREEN DISPLAY (OSD) MENU SETTINGS</b> .....             | <b>25</b> |
| OSD MENU CONTROLS .....  | 25        |
| <i>Navigating the OSD</i> .....                                | 25        |
| SETTING THE OSD LANGUAGE .....                                 | 26        |
| OSD MENU OVERVIEW .....  | 27        |
| IMAGE MENU.....  | 30        |
| <i>Advanced Feature</i> .....                                  | 31        |
| <i>Color Manager</i> .....                                     | 32        |
| COMPUTER MENU.....   | 33        |
| VIDEO MENU .....   | 34        |
| <i>Audio</i> .....   | 35        |
| INSTALLATION I MENU .....                                      | 36        |
| <i>Advanced Feature</i> .....                                  | 37        |
| INSTALLATION II MENU.....                                      | 38        |
| <i>Advanced Feature</i> .....                                  | 39        |
| <i>OSD Menu Setting</i> .....                                  | 40        |
| <i>Peripheral Test</i> .....                                   | 40        |
| <i>Reset Lamp Time</i> .....                                   | 41        |
| <i>3D</i> .....  | 41        |
| <i>Network Setting</i> .....                                   | 42        |
| <i>Factory Reset</i> .....                                     | 51        |
| <i>Status</i> .....  | 51        |
| <b>MAINTENANCE AND SECURITY</b> .....                          | <b>52</b> |
| REPLACING THE PROJECTION LAMP.....                             | 52        |
| <i>Resetting the Lamp Time</i> .....                           | 54        |
| CLEANING THE PROJECTOR.....                                    | 55        |
| <i>Cleaning the Projector Mirror</i> .....                     | 55        |
| USING THE PHYSICAL LOCK .....                                  | 56        |
| <i>Using the Kensington® Lock</i> .....                        | 56        |
| <i>Using the Security Bar</i> .....                            | 56        |
| <b>TROUBLESHOOTING</b> .....                                   | <b>57</b> |
| TIPS FOR TROUBLESHOOTING .....                                 | 57        |
| LED MESSAGES .....   | 58        |
| IMAGE PROBLEMS.....  | 58        |
| LAMP PROBLEMS .....  | 59        |
| REMOTE CONTROL PROBLEMS .....                                  | 59        |
| AUDIO PROBLEMS .....   | 59        |
| HAVING THE PROJECTOR SERVICED .....                            | 59        |

|   |           |
|---|-----------|
| <b>SPECIFICATIONS</b> .....                       | <b>60</b> |
| PRODUCT SPECIFICATIONS .....                      | 60        |
| INSTALLATION DISTANCE VS. PROJECTION SIZE .....   | 61        |
| <i>Installation Distance and Size Table</i> ..... | 61        |
| TIMING MODE TABLE .....                           | 62        |
| PROJECTOR DIMENSIONS .....                        | 64        |
| <b>APPENDIX I</b> .....                           | <b>66</b> |
| COMMUNICATION .....                               | 66        |

# SAFETY INSTRUCTIONS



Before installing and operating the projector, read this manual thoroughly.

This projector provides many convenient features and functions. Operating the projector properly enables you to manage those features and maintain it in good condition for many years to come.

Improper operation may result in not only shortening the product life, but also malfunctions, fire hazards, or other accidents.

If your projector does not seem to be operating properly, read this manual again, check operations and cable connections, and try the solutions in the “Troubleshooting” section in the user’s manual. If the problem still persists, contact the Canon Customer Support Center.

|   |   |   |
|---|---|---|
|  | <b>CAUTION</b><br><b>RISK OF ELECTRIC SHOCK</b><br><b>DO NOT OPEN</b> |  |
|---|---|---|

|  |   |
|--|---|
|   | THIS SYMBOL INDICATES THAT DANGEROUS VOLTAGE CONSTITUTING A RISK OF ELECTRIC SHOCK IS PRESENT WITHIN THIS UNIT.           |
|  | THIS SYMBOL INDICATES THAT THERE ARE IMPORTANT OPERATING AND MAINTENANCE INSTRUCTIONS FOR THIS UNIT IN THE USER’S MANUAL. |

|  |
|--|
| <b>CAUTION</b><br>Not for use in a computer room as defined in the Standard for the Protection of Electronic Computer / Data Processing Equipment, ANSI / NFPA 75. |
|--|

|   |
|---|
| <p><b>Copyright notice</b></p> <p>Please note that enlarging or reducing the size of an image for commercial purposes or public presentation any infringe on the legally protected copyright or the copyright holder of the original material</p> <p><b>About Trademarks</b></p> <ul style="list-style-type: none"><li>• Ethernet is a registered trademark of Xerox Corporation.</li><li>• Microsoft, Windows, Windows XP, Windows Vista, Windows 7, Windows 8 and Aero are registered trademarks or trademarks of Microsoft Corporation in the United States and / or other countries.</li><li>• Mac, Mac OS and Macintosh are trademarks of Apple Inc., registered in the United States and / or other countries.</li><li>• HDMI, the HDMI logo and High-Definition Multimedia Interface are trademarks or registered trademarks of HDMI Licensing, LLC.</li><li>• PJLink is a registered trademark, or an application has been submitted for trademark, in Japan, the United States and / or other countries or regions.</li><li>• Crestron®, Crestron RoomView®, and Crestron Connected™ are registered trademarks of Crestron Electronics, Inc.</li></ul> |
|---|



## Safety Precautions

### WARNING:

- **THIS APPARATUS MUST BE GROUNDED.**
- **TO REDUCE THE RISK OF FIRE OR ELECTRIC SHOCK, DO NOT EXPOSE THIS APPLIANCE TO RAIN OR MOISTURE.**
- This projector produces intense light from the projection lens. Do not stare directly into the lens, otherwise eye damage could result. Be especially careful that children do not stare directly into the beam.
- Install the projector in a proper position. Otherwise it may result in a fire hazard.
- Do not cover the ventilation slots on the projector. Heat build-up can reduce the service life of your projector, and can also be dangerous.
- If the projector is unused for an extended time, unplug the projector from the power outlet.
- Do not project the same image for a long time.

An afterimage may remain on the DMD panel due to the characteristics of the panel of the projector.



## CAUTION ON HANGING FROM THE CEILING

When hanging the projector from the ceiling, clean the air intake vents and top of the projector periodically with a vacuum cleaner. If you leave the projector unclean for a long time, the cooling fans can be clogged with dust, and it may cause a breakdown or a disaster.

**DO NOT SET THE PROJECTOR IN GREASY, WET, OR SMOKY CONDITIONS SUCH AS IN A KITCHEN TO PREVENT A BREAKDOWN OR A DISASTER. IF THE PROJECTOR COMES IN CONTACT WITH OIL OR CHEMICALS, IT MAY BECOME DETERIORATED.**

### ■ READ AND KEEP THIS MANUAL FOR LATER USE.

All the safety and operating instructions should be read before beginning to operate the product.

Read all of the instructions given here and retain them for later use. Unplug this projector from the AC power supply before cleaning. Do not use liquid or aerosol cleaners on the projector. Use a damp cloth for cleaning.

Follow all warnings and instructions marked on the projector.

For added protection of the projector during a lightning storm, or when it is left unattended or unused for long periods of time, unplug it from the wall outlet. This will prevent damage due to lightning and power surges.

---

Do not expose this unit to rain or use near water. For example, in a wet basement, near a swimming pool..., etc.

Do not use attachments not recommended by the manufacturer as they may result in hazards.



Do not place this projector on an unstable cart, stand, or table. The projector may fall, causing serious injury to a child or adult, and serious damage to the projector. Use only with a cart or stand recommended by the manufacturer, or sold with the projector. For wall or shelf mounting, use a tool such as a mounting kit to secure the projector.

An appliance and cart combination should be moved with care. Sudden stops, excessive force, and uneven surfaces may cause the appliance and cart combination to overturn.



Slots and openings in the rear and front of the cabinet are provided for ventilation, to insure reliable operation of the equipment and to protect it from overheating.

The openings should never be covered with cloth or other materials, and the bottom opening should not be blocked by placing the projector on a bed, sofa, rug, or other similar surface. This projector should never be placed near or over a radiator or heat register.

This projector should not be placed in a built-in installation such as a book case unless proper ventilation is provided.

Never push objects of any kind into this projector through cabinet slots as they may touch dangerous voltage points or short out parts that could result in a fire or electric shock. Never spill liquid of any kind onto the projector.

Do not install the projector near the ventilation duct of air-conditioning equipment.

This projector should be operated using only the type of power source indicated on the marking label. If you are not sure of the type of power supplied, contact the Canon Customer Support Center or local power company.

Do not overload wall outlets and extension cords as this can result in fire or electric shock. Do not allow anything to rest on the power cord. Do not locate this projector where the cord may be damaged by people walking on it.

Do not attempt to service this projector yourself as opening or removing covers may expose you to dangerous voltages or other hazards. Refer all servicing to qualified service personnel.

Unplug this projector from the wall outlet and refer servicing to qualified service personnel under the following conditions:

- a. When the power cord or plug is damaged or frayed.
- b. If liquid has been spilled into the projector.
- c. If the projector has been exposed to rain or water.
- d. If the projector does not operate normally after following the operating instructions. Adjust only those controls that are covered in the operating instructions as improper adjustment of other controls may result in damage and will often require extensive work by a qualified technician to restore the projector to normal operating condition.
- e. If the projector has been dropped or the cabinet has been damaged.
- f. When the projector exhibits a distinct change in performance-this indicates a need for servicing.

When replacement parts are required, be sure the service technician uses replacement parts specified by the manufacturer that have the same characteristics as the original parts. Unauthorized substitutions may result in fire, electric shock, or injury.

Upon completion of any service or repairs to this projector, ask the service technician to perform routine safety checks to determine that the projector is in safe operating condition.

## AC Power Cord Requirement

The AC Power Cord supplied with this projector meets the requirements for use in the country you purchased it.

### AC Power Cord for the United States and Canada:

The AC Power Cord used in the United States and Canada is listed by the Underwriters Laboratories (UL) and certified by the Canadian Standard Association (CSA).

The AC Power Cord has a grounding-type AC line plug. This is a safety feature to ensure the plug fits into the power outlet. Do not try to tamper with this safety feature. Should you be unable to insert the plug into the outlet, contact your electrician.

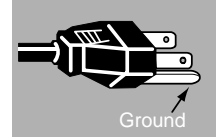

### THE SOCKET-OUTLET SHOULD BE INSTALLED NEAR THE EQUIPMENT AND EASILY ACCESSIBLE.



For the U.S. and Canada, LAMP(S) INSIDE THIS PRODUCT CONTAIN MERCURY AND MUST BE RECYCLED OR DISPOSED OF ACCORDING TO LOCAL, MUNICIPAL, STATE, PROVINCIAL, OR FEDERAL LAWS.

For lamp recycling and disposal information please call 1-800-OK-CANON for the U.S and Canada.



### Only for European Union and EEA (Norway, Iceland and Liechtenstein)

These symbols indicate that this product is not to be disposed of with your household waste, according to the WEEE Directive (2012/19/EU), the Battery Directive (2006/66/EC) and/or national legislation implementing those Directives.

If a chemical symbol is printed beneath the symbol shown above, in accordance with the Battery Directive, this indicates that a heavy metal (Hg = Mercury, Cd = Cadmium, Pb = Lead) is present in this battery or accumulator at a concentration above an applicable threshold specified in the Battery Directive.



This product should be handed over to a designated collection point, e.g., on an authorized one-for-one basis when you buy a new similar product or to an authorized collection site for recycling waste electrical and electronic equipment (EEE) and batteries and accumulators. Improper handling of this type of waste could have a possible impact on the environment and human health due to potentially hazardous substances that are generally associated with EEE. Your cooperation in the correct disposal of this product will contribute to the effective usage of natural resources.

For more information about the recycling of this product, please contact your local city office, waste authority, approved scheme or your household waste disposal service or visit <http://www.canon-europe.com/weee>, or <http://www.canon-europe.com/battery>.

### For CA, USA only

Included lithium battery contains Perchlorate Material - special handling may apply.

See [www.dtsc.ca.gov/hazardouswaste/perchlorate/](http://www.dtsc.ca.gov/hazardouswaste/perchlorate/) for details.

## **Federal Communication Commission Notice**

Multimedia Projector, Model: LV-WX300UST/LV-WX300USTi

This device complies with Part 15 of the FCC Rules. Operation is subject to the following two conditions:

- (1) This device may not cause harmful interference, and
- (2) this device must accept any interference received, including interference that may cause undesired operation.

Note: This equipment has been tested and found to comply with the limits for a Class B digital device, pursuant to Part 15 of the FCC Rules. These limits are designed to provide reasonable protection against harmful interference in a residential installation. This equipment generates, uses and can radiate radio frequency energy and, if not installed and used in accordance with the instructions, may cause harmful interference to radio communications. However, there is no guarantee that interference will not occur in a particular installation. If this equipment does cause harmful interference to radio or television reception, which can be determined by turning the equipment off and on, the user is encouraged to try to correct the interference by one or more of the following measures:

- Reorient or relocate the receiving antenna.
- Increase the separation between the equipment and receiver.
- Connect the equipment into an outlet on a circuit different from that to which the receiver is connected.
- Consult the dealer or an experienced radio / TV technician for help.

The cable with a ferrite core provided with the projector must be used with this equipment in order to comply with Class B limits in Subpart B of Part 15 of the FCC Rules.

Use of a shielded cable is required to comply with class B limits in Subpart B of Part 15 of FCC Rules.

Do not make any changes or modifications to the equipment unless otherwise specified in the instructions. If such changes or modifications should be made, you could be required to stop operation of the equipment.

Canon U.S.A. Inc.

One Canon Park, Melville, New York 11747, U.S.A.

Tel No. 1-800-OK-CANON (1-800-652-2666)

## **Safety Symbols in this Manual**

This section describes the safety symbols used in this manual. Important projector safety information is identified by the following symbols. Always observe the safety information by these symbols.



Denotes the risk of death or serious injury from improper handling if the information is not observed. To ensure safe use, always observe this information.



Denotes the risk of injury from improper handling if the information is not observed. To ensure safe use, always observe this information.

## Precautions for Use

As this section contains important safety-related information, be sure to read the following carefully beforehand in order to use your projector correctly and safely.

### Warning

If the following situations occur, turn the power off, remove the power plug from the power outlet and contact the Canon Customer Support Center. Failure to do so could cause a fire or result in an electric shock.

- If smoke is emitted
- If an unusual smell or noise is emitted
- If a loud noise is heard and the light source turns off
- If water or other liquid has entered the projector
- If metal or any other foreign material has entered the projector
- If the projector is knocked over or dropped and the cabinet is damaged

### Warning

Pay attention to the following points for handling the power cord. Failure to pay attention to these points could cause a fire, electric shock or personal injury.

- Do not place any objects on the power cord and do not allow it to become trapped under the projector. The power cord may be damaged.
- Do not cover the power cord with a carpet.
- Do not excessively bend, twist, pull or make modifications to the power cord.
- Keep the power cord away from heaters and other sources of heat.
- Do not use the power cord when it is bent finely, coiled or bundled.
- Do not use a damaged power cord. If your power cord is damaged, contact the Canon Customer Support Center.
- Do not use any power cord other than the type that is included with this projector.
- Be sure to connect the ground wire of the power cord to ground. Failure to do so could result in an electric shock.
- Be sure to connect the ground wire before connecting the power plug to the outlet. Also when you disconnect the ground wire, be sure to unplug the power plug from the outlet beforehand.

### Warning

Pay attention to the following point to prevent the small parts from being accidentally swallowed by children.

- Small parts such as the remote control battery, battery holder and adjustable feet that were detached may be accidentally swallowed by small children, which may result in choking. Parents/Guardians should keep them out of reach of children. If swallowed, consult a doctor immediately.

## Warning

Pay attention to the following points regarding the power source, power plug and handling of the connector. Failure to do so could result in a fire, electric shock or personal injury.

- Do not use any power source with a voltage other than the voltage indicated (AC 100 – 240 V).
- Do not pull the power cord and be sure to hold the power plug or connector when removing. The cord could be damaged as a result.
- Do not insert any metal objects into the contact parts of the power plug or connector.
- Remove the power plug from the outlet before performing cleaning or maintenance of the projector.
- Do not remove the power plug or connector with wet hands.
- Insert the power plug and connector securely up to the base. Additionally, do not use a damaged power plug or an outlet that is loose.
- If using an extension cord attached to the outlet, make sure that the total electric power consumption of connected devices does not exceed the rated capacity.
- Periodically inspect the power plug and outlet and remove any dust or dirt from between the plug and the outlet.

## Precautions for Installation

### Warning

Pay attention to the following points regarding installation and handling of the projector. Failure to do so may cause a fire, electric shock or personal injury.

- Do not use the projector in a bathroom or shower room.
- Do not use the projector in rain or snow, by the sea, or in close proximity to a body of water.
- Do not place containers containing a liquid on top of the projector.
- Do not place the projector in any location where it will be exposed to oily smoke or steam, such as a kitchen work surface or table etc.
- Do not touch the projector itself, the power cord, or the cable if lightning strikes.

### Warning

Pay attention to the following points regarding installation and handling of the projector. Failure to do so may cause a fire, electric shock or personal injury.

- Do not move the projector until you have switched off the power, removed the power plug from the power outlet and unplugged any other cables.
- Do not remove the cabinet from the projector or disassemble it. The interior of the projector contains high-voltage components as well as parts that are hot. These could cause an electric shock or burn. If inspection, maintenance or repair is required, contact the Canon Customer Support Center.
- Do not disassemble or modify the projector (including consumable parts) or the remote control.
- Do not insert any object into vents in the projector, such as the air intake vent or exhaust vents.
- Do not place a pressurized can in front of the exhaust vents. The pressure of the contents of the can may increase due to heat from the exhaust vents and this could result in an explosion.
- As strong light beams are emitted while the projector is in use, do not look directly into the projector lens. Doing so could cause an eye injury. Pay particular attention in preventing young children to do so.
- When giving a presentation in front of the projector while it is projecting an image, conduct your presentation from a position where your shadow will not be cast on the screen and where you do not feel blinded by light from the projector.

## Caution

Pay attention to the following points regarding installation and handling of the projector.

- If the projector will not be used for a long period of time, be sure to remove the power plug from the power outlet to ensure safety. Failure to do so could cause a fire.
- The temperature of the cabinet around and above the exhaust vents can become hot during projector operation. Touching these areas during operation could cause burns to the hands. Do not touch these areas. Doing so may cause burns. Pay particular attention in preventing young children from touching these parts. Additionally, do not place any metal objects on these areas. Due to the heat from the projector, doing so could cause an accident or personal injury.

## Caution

Pay attention to the following points regarding installation and handling of the projector.

- Do not place any heavy objects on top of the projector or sit/stand on it. Pay particular attention to prevent small children from doing so. The projector may be knocked over and this could result in damage or a personal injury.
- Do not place the projector on an unstable or slanted surface. Doing so may cause the projector to fall or be knocked over and could result in a personal injury.
- Do not place any objects in front of the lens while the projector is operating. Doing so could cause a fire.
- When cleaning off dust or dirt from the projector lens etc., do not use any kind of spray that is flammable. As the temperature of the lamp inside the projector is high, it could ignite, causing a fire.
- If the projector is used for a long period of time, dust could accumulate inside the projector. This could cause a fire or malfunction. It is recommended that periodic maintenance of the projector be performed. For details of maintenance costs, contact the Canon Customer Support Center.

## Precautions on the lamp

This projector uses a high-pressure mercury lamp, which must be handled carefully and correctly as described below. The mercury lamp has the following characteristics.

- The lamp will gradually become darker over time.
- Impact, abrasion, or use of worn-out lamps may cause lamps to rupture (accompanied by a loud noise) or burn out.
- Lamps are more likely to rupture after the lamp replacement message is displayed. Replace the lamp with a new one as soon as possible.
- Useful life of lamps varies widely from lamp to lamp and depending on the environment of use. Some lamps may fail or rupture soon after they are first used.
- Be prepared by keeping a spare lamp.

## Warning

Note the following precautions during lamp replacement or when a lamp has ruptured.

Failure to do so could result in an electric shock or personal injury.

- Before replacing the lamp, always unplug the projector and wait at least an hour.
- Ruptured lamps may scatter shards of glass inside the projector. Contact the Canon Customer Support Center for cleaning and inspection of the projector interior and lamp replacement.

## Warning

### Precautions when replacing lamps that stop working

- If illumination suddenly stops, either when you turn the projector on or after it has been on for a while, the lamp may have ruptured. In this case, never attempt to replace the lamp by yourself. Always request service from the Canon Customer Support Center. Additionally, with ceiling-mounted projectors, the lamp may fall out when you open the lamp cover or while you are attempting to replace it.
- During replacement, stand to the side of the lamp cover, not directly under it. If the lamp ruptures and you accidentally inhale or get pieces in your eyes or mouth, consult a doctor immediately.
- If the lamp ruptures, dust and gas (containing mercury vapor) may come out of the exhaust vents. If this happens, immediately open the windows and doors to provide ventilation to the room. If you inhale any gas emitted from the lamp or it has come into contact with your eyes or mouth, consult a doctor immediately.

## Precautions for the remote control battery

### Warning

Pay attention to the following points regarding handling of the battery. Failure to do so could result in a fire or injury.

- Do not place the battery in a fire or apply heat to, short circuit or disassemble the battery.
- Do not attempt to recharge the battery.
- Insert the battery in the correct + / - positions.
- If any liquid leaks from the battery and comes into contact with skin, wash off thoroughly with water

## Caution for viewing 3D content

### Caution

Pay attention to the following points when viewing 3D content.

- Photosensitive patients, patients with heart disease, pregnant women, elderly people, and people with serious illness and/or with a history of epilepsy should not view 3D content.
- We advise that you should refrain from viewing 3D content if you are in bad physical condition, need sleep or have been drinking alcohol.
- Stop watching 3D content if you experience the following symptoms. If you experience such symptom, immediately stop viewing 3D content and take a break until the symptom has subsided.
  - You see doubly-blurred images or you cannot view the image stereoscopically.
  - You feel fatigue or discomfort.
- Take breaks when viewing 3D content for an extended period of time. As this may cause eye fatigue. Viewing 3D content for an extended period of time or viewing them from an oblique angle can cause eye strain.
- Parents should accompany and monitor their children as children cannot properly express discomfort with 3D content viewing. Children who are six year of age or younger should not view 3D content.
- The optimum 3D viewing distance from the screen is about 3 times of the vertical screen size or more and your eyes should be level with the screen.

## For Safe Use

Pay attention to the following points when carrying or transporting the projector.

- This projector is a precision instrument. Do not knock it over or subject it to impacts. Doing so may cause a malfunction.
- Do not reuse any packaging or shock-absorbent materials that were supplied with the projector at the time of purchase for transporting or shipping the projector. Protection of the projector cannot be guaranteed if used packaging or shock-absorbent materials are reused. Fragments from shock absorbent material may also enter the interior of the projector which could cause a malfunction.
- Disconnect the cables connected to the projector. Carrying the projector with the cables attached may cause an accident.
- Retract the adjustable feet.
- Attach the lens cap to protect the lens.

Pay attention to the following points when installing or using the projector.

- Be sure to install the projector in a location where the air intake and exhaust vents are separated from the wall by more than 50 cm (1.6'). Failure to do so could cause a malfunction.
- Do not install the projector in a location that is damp, or where there is a lot of dust, oily smoke or tobacco smoke. Doing so could cause contamination of optical components such as the lens and the mirror and may result in deterioration of image quality.
- Do not touch the lens with bare hands. Doing so may result in deterioration of image quality.
- If the projector is suddenly moved from a location where the temperature is low to a location where the temperature is high, or if the temperature in the location where the projector is installed increases suddenly, moisture in the air could cause condensation to form on the projector lens or mirror. This may cause a blurred image. Wait until the condensation has evaporated for the image projected to return to normal.
- Do not install the projector in a location where the temperature is high or low. Doing so may cause a malfunction.

Operating temperature: 5°C (41°F) to 40°C (104°F)

Humidity level: 10% to 90%

Storage temperature: -20°C (-4°F) to 60°C (140°F)

- Do not install the projector near high-voltage electrical power lines or an electrical power source.
- Do not use the projector on a soft surface such as carpet or sponge mat, etc. Doing so could cause heat to build up inside the projector and this could result in a malfunction.
- Do not block the air intake or exhaust vents of the cooling fan. Doing so could cause heat to build up inside the projector and may cause a malfunction.
- Do not place any objects on top of the projector that may change shape or color due to heat.
- When using the projector at altitudes greater than 1500 m (4921'), please turn on the High Altitude Mode.
- Please do not brush or rub the surface of the top plate of the projector. The surface may be damaged.



## Packing Checklist

Carefully unpack the projector and check that the following items are included:

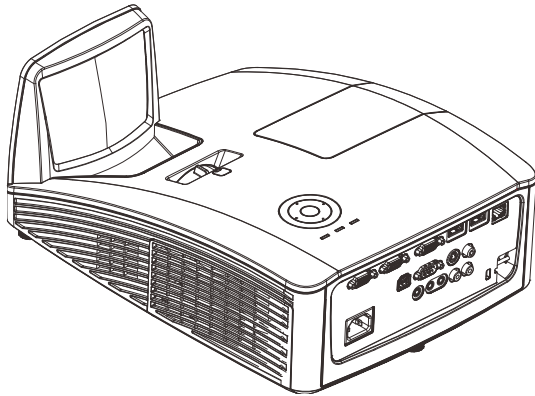

*LV-WX300UST*

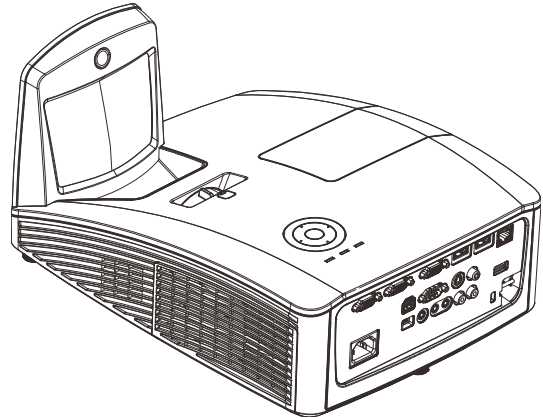

*LV-WX300USTi*

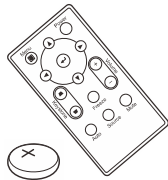

*REMOTE CONTROL  
(WITH ONE 3V CR2025 BATTERY)*

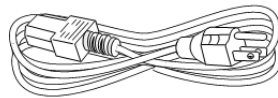

*POWER CORD (1.8 M / 5.9')*

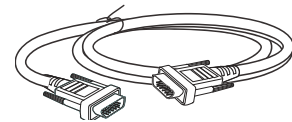

*COMPUTER CABLE (1.8 M / 5.9')  
(MINI D-SUB 15-PIN / MINI D-SUB 15-PIN)*



*CD-ROM  
(THIS USER'S MANUAL)*

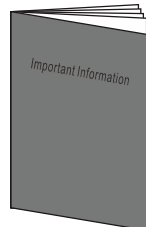

*IMPORTANT INFORMATION*

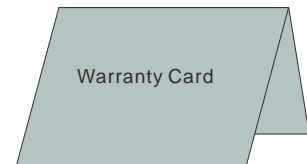

*WARRANTY CARD*

### The Following ITEMS only for LV-WX300USTi



*CD-ROM  
(INTERACTIVE DRIVER AND  
SOFTWARE)*

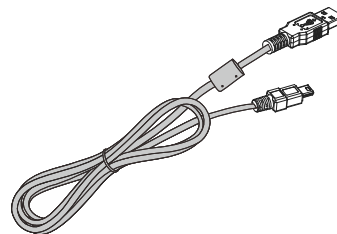

*USB CABLE  
(A-TYPE TO MINI 5.0M / 16.4')*

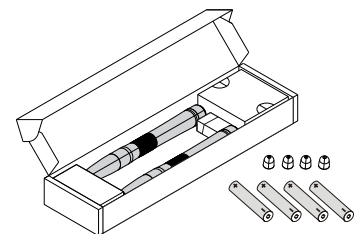

*TWO PENS  
(WITH FOUR AAA BATTERIES &  
FOUR TIPS)*

Contact your dealer immediately if any items are missing, appear damaged, or if the unit does not work. It is recommended that you keep the original packing material should you ever need to return the equipment for warranty service.

## Views of Projector Parts

### Front-right View

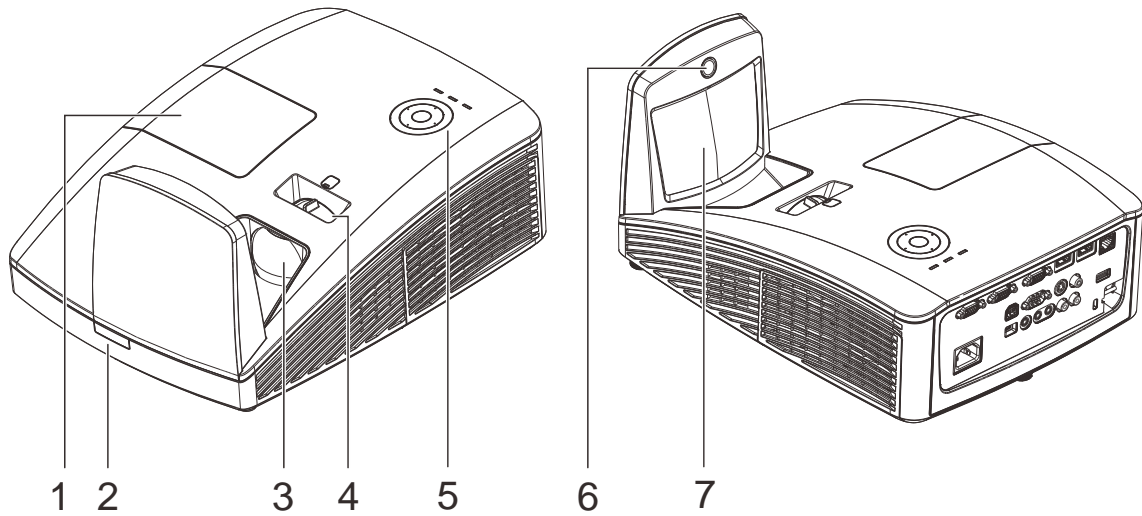

| ITEM | LABEL              | DESCRIPTION   | SEE PAGE: |
|------|--------------------|---|-----------|
| 1.   | Lamp cover         | Removes cover to replace lamp module / unit ---> lamp     |           |
| 2.   | IR receiver        | Receives IR signal from remote control                    |           |
| 3.   | Lens               | Projection Lens   |           |
| 4.   | Focus ring         | Focuses the projected image                               |           |
| 5.   | Function keys      | See Top view—On-screen Display (OSD) buttons and LEDs.    | <b>13</b> |
| 6.   | Interactive Camera | Interactive function use<br>*Not Available in LV-WX300UST |           |
| 7.   | Aspheric mirror    | Reflects images   |           |

Top view—On-screen Display (OSD) buttons and LEDs

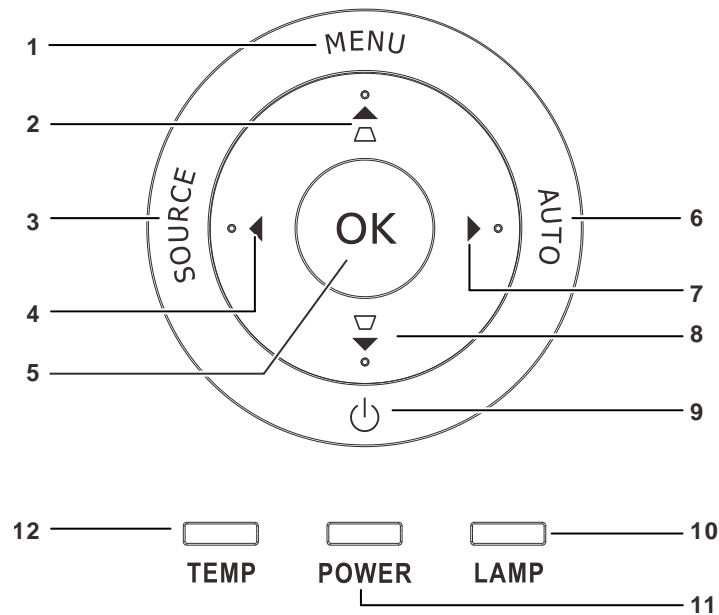

| ITEM | LABEL     | DESCRIPTION                                       |                     | SEE PAGE: |
|------|-----------|---|---------------------|-----------|
| 1.   | MENU      | Opens and exits OSD menus                         |                     | 25        |
| 2.   | ▲<br>△    | Navigates in the OSD<br>Quick Menu – For Keystone |                     |           |
| 3.   | SOURCE    | Enter the Source menu                             |                     |           |
| 4.   | ◀         | Navigates and changes settings in the OSD         |                     | 25        |
| 5.   | OK        | Enter or confirm highlighted OSD menu item        |                     |           |
| 6.   | AUTO      | Optimizes image size, position, and resolution    |                     |           |
| 7.   | ▶         | Navigates and changes settings in the OSD         |                     | 25        |
| 8.   | ▽<br>▼    | Navigates in the OSD<br>Quick Menu – For Keystone |                     |           |
| 9.   | ⏻         | Turns the projector On or Off                     |                     |           |
| 10.  | LAMP LED  | Amber   | Lamp error          | 58        |
|      |           | Flashing  | Error code          |           |
| 11.  | POWER LED | Green   | Power on, Power off |           |
|      |           | Flashing  | Cooling, Error code |           |
| 12.  | TEMP LED  | Red   | Over Temperature    |           |

Rear view

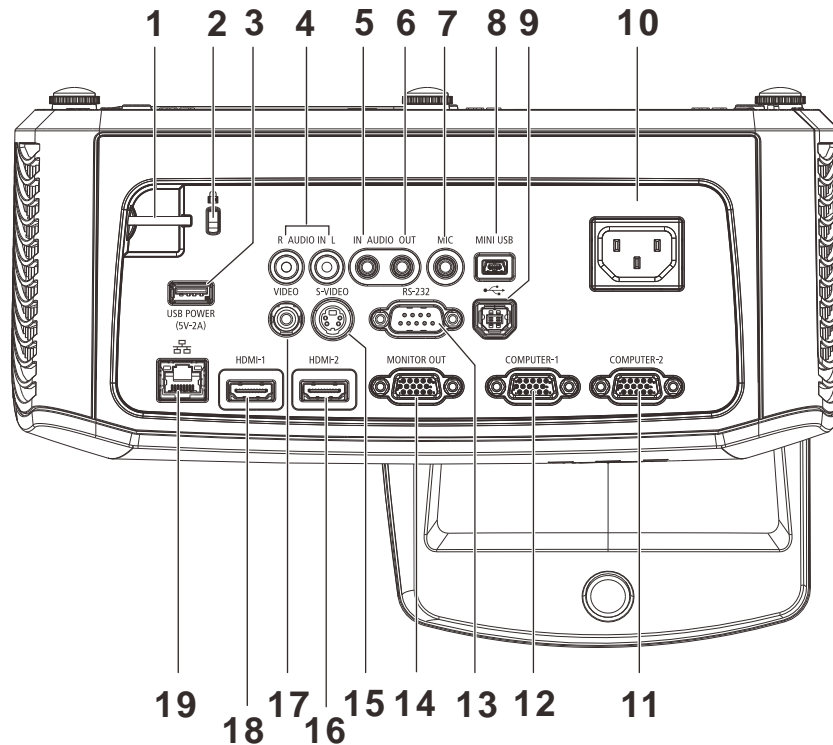

| ITEM | LABEL                             | DESCRIPTION  | SEE PAGE: |
|------|-----------------------------------|--|-----------|
| 1.   | Security bar                      | For security and authorized usage  | 56        |
| 2.   | Kensington lock                   | Secure to permanent object with a Kensington® Lock system  |           |
| 3.   | USB POWER (5V-2A)                 | Connect the USB cable for power supply.(for Interactive function)<br>*not available in LV-WX300UST |           |
| 4.   | AUDIO L/R<br>(For VIDEO/ S-VIDEO) | Connect an AUDIO cable from the audio device   |           |
| 5.   | AUDIO IN<br>(For VGA-1/ VGA-2)    | Connect an AUDIO cable from the audio device   |           |
| 6.   | AUDIO OUT                         | Connect an AUDIO cable to an audio amplifier   |           |
| 7.   | MIC                               | Connect the Microphone for use   |           |
| 8.   | Mini USB                          | Connect the USB cable to PC(for Interactive function)<br>*not available in LV-WX300UST             |           |
| 9.   | USB                               | Connect the USB cable from a computer  |           |
| 10.  | AC IN                             | Connect the POWER cable  | 20        |
| 11.  | VGA – 2                           | Connect the RGB cable from a computer or components device   |           |
| 12.  | VGA – 1                           | Connect the RGB cable from a computer or components device   |           |
| 13.  | RS-232                            | Connect RS-232 serial port cable for remote control  |           |
| 14.  | VGA OUT                           | Connect the RGB cable to a display<br>(Loop Thru only for VGA IN-1)                                |           |
| 15.  | S-VIDEO                           | Connect the S-video cable from a video device  |           |

| ITEM | LABEL   | DESCRIPTION                                     | SEE PAGE: |
|------|---------|---|-----------|
| 16.  | HDMI 2  | Connect the HDMI cable from a HDMI device*      |           |
| 17.  | VIDEO   | Connect the composite cable from a video device |           |
| 18.  | HDMI 1  | Connect the HDMI cable from a HDMI device*      |           |
| 19.  | RJ – 45 | Connect a LAN cable from Ethernet               |           |

\* It is necessary to turn the 3D setting off in case of connecting with some digital cameras by HDMI.

**Note:**

- *If your video equipment has various input sources, it is recommended to connect in priority of HDMI/DVI, component (thru VGA), Composite for better picture quality.*
- *When MIC insertion machine, only MIC sound.*

Bottom view

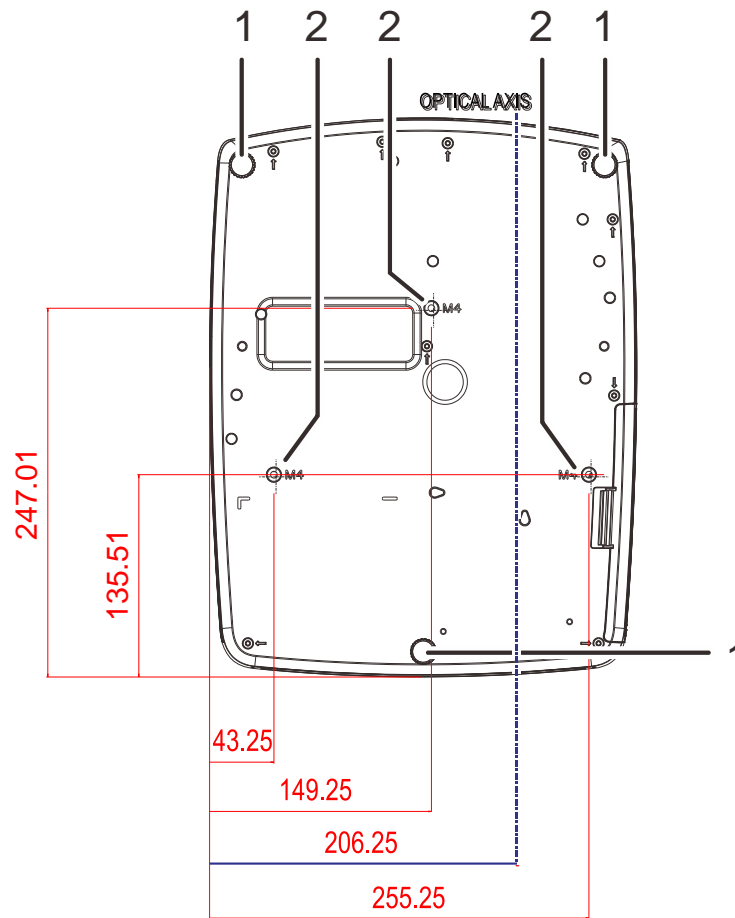

| ITEM | LABEL                 | DESCRIPTION  | SEE PAGE: |
|------|-----------------------|--|-----------|
| 1.   | Tilt adjustor         | Rotate adjuster lever to adjust angle position                             | <b>23</b> |
| 2.   | Ceiling support holes | Contact your dealer for information on mounting the projector on a ceiling |           |

 **Warning:**  
*The ceiling attachment (part No.: LV-WL02) is required in order to mount the projector on the wall.  
 Make sure to ask the Canon Customer Support Center if you want to install the Wall Attachment.*

## Remote Control Parts

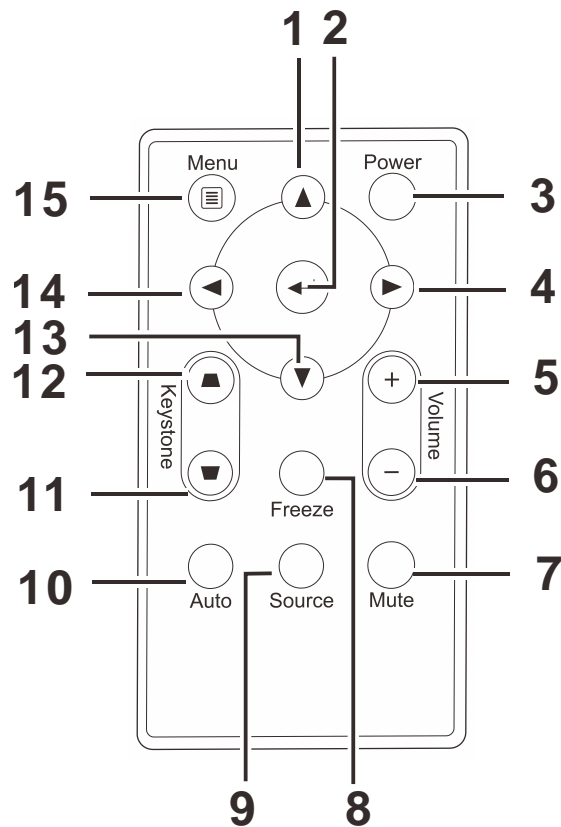

**Important:**

1. Avoid using the projector with bright fluorescent lighting turned on. Certain high-frequency fluorescent lights can disrupt remote control operation.

2. Be sure nothing obstructs the path between the remote control and the projector. If the path between the remote control and the projector is obstructed, you can bounce the signal off certain reflective surfaces such as projector screens.

3. The buttons and keys on the projector have the same functions as the corresponding buttons on the remote control. This user's manual describes the functions based on the remote control.

| ITEM | LABEL           | DESCRIPTION  | SEE PAGE: |
|------|-----------------|--|-----------|
| 1.   | Up cursor       | Navigates and changes settings in the OSD                          | 25        |
| 2.   | Enter           | Changes settings in the OSD  |           |
| 3.   | Power           | Turns the projector On or Off                                      | 20        |
| 4.   | Right cursor    | Navigates and changes settings in the OSD                          | 25        |
| 5.   | Volume +        | Increase volume  | 24        |
| 6.   | Volume -        | Decrease volume  |           |
| 7.   | Mute            | Mutes the built-in speaker   |           |
| 8.   | Freeze          | Freeze/unfreezes the on-screen picture                             |           |
| 9.   | Source          | Detects the input device   |           |
| 10.  | Auto            | Auto adjustment for frequency, tracking, size, position (RGB only) |           |
| 11.  | Keystone top    | Corrects image-trapezoid (wider top) effect                        | 24        |
| 12.  | Keystone bottom | Corrects image trapezoid (wider bottom) effect                     |           |
| 13.  | Down cursor     | Navigates and changes settings in the OSD                          | 25        |
| 14.  | Left cursor     | Navigates and changes settings in the OSD                          |           |
| 15.  | Menu            | Opens the OSD  |           |

## Remote Control Operating Range

The remote control uses infrared transmission to control the projector. It is not necessary to point the remote directly at the projector. Provided you are not holding the remote perpendicular to the sides or the rear of the projector, the remote will function well within a radius of about 7 meters (23 feet) and 15 degrees above or below the projector level. If the projector does not respond to the remote control, move a little closer.

## Projector and Remote Control Buttons

The projector can be operated using the remote control or the buttons on the top of the projector. All operations can be carried out with the remote control; however, the buttons on the projector are limited in use.



### Inserting the Remote Control Batteries

1. Remove the battery compartment cover by sliding the cover in the direction of the arrow (A). Pull out the cover (B)..

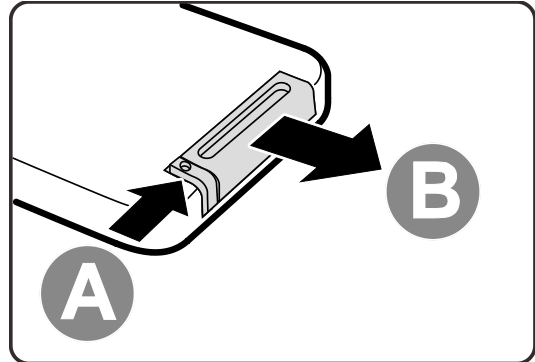

2. Insert the battery with the positive side facing up.

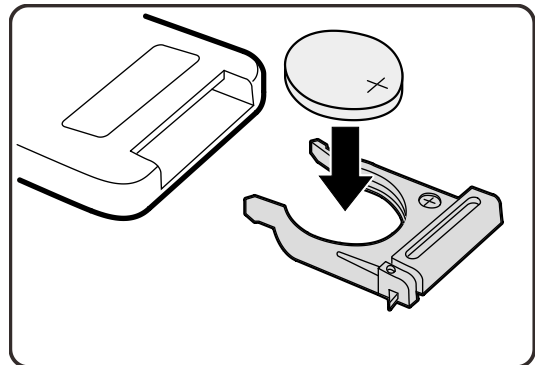

3. Replace the cover.

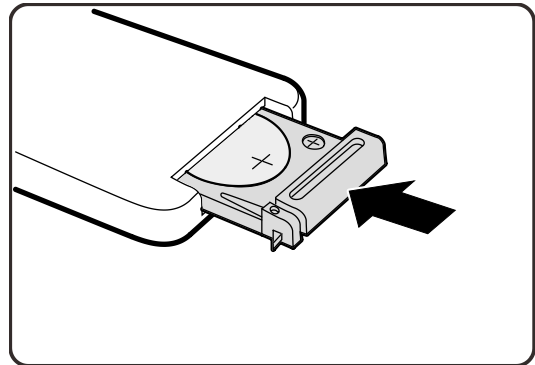

**Caution:**

1. Only use a 3V lithium battery (CR2025).

2. Dispose of used batteries according to local ordinance regulations.

3. Remove the battery when not using the projector for prolonged periods.

## Starting and Shutting down the Projector

1. Connect the power cord to the projector. Connect the other end to a wall outlet.
2. Turn on the connected devices.
3. Ensure the **POWER** LED displays a solid green. Then press the **POWER** button of the remote to turn on the projector.

The projector splash screen displays and connected devices are detected.

See [Setting an Access Password \(Security Lock\)](#) on page 21 if security lock is enabled.

4. If more than one input device is connected, press the **SOURCE** button of the remote and use ▲▼ to scroll among devices. (Component is supported through the RGB to COMPONENT ADAPTER.)

5. When the “Power Off? /Press Power again” message appears, press the **POWER** button. The projector turns off.

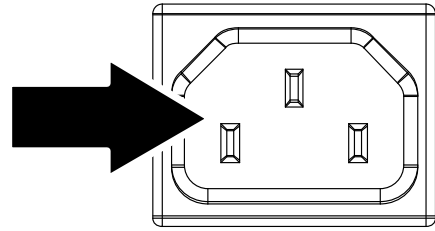

- VGA 1/VGA 2: Analog RGB  
Component: DVD input YCbCr / YPbPr, or HDTV input YPbPr via HD15 connector
- Composite Video: Traditional composite video
- S-Video: Super video (Y/C separated)
- HDMI1/HDMI2: HDMI, DVI

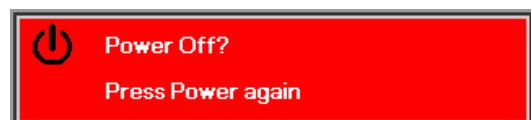

### **Caution:**

Do not unplug the power cord until the **POWER LED** solid green—indicating the projector has cooled down.

## Setting an Access Password (Security Lock)

You can use the four (arrow) buttons to set a password and prevent unauthorized use of the projector. When enabled, the password must be entered after you power on the projector. (See [Navigating the OSD](#) on page 25 and [Setting the OSD Language](#) on page 26 for help on using OSD menus.)

**Important:**

Keep the password in a safe place. Without the password, you will not be able to use the projector. If you lose the password, contact your reseller for information on clearing the password.

1. Press the **MENU** button to open the OSD menu.

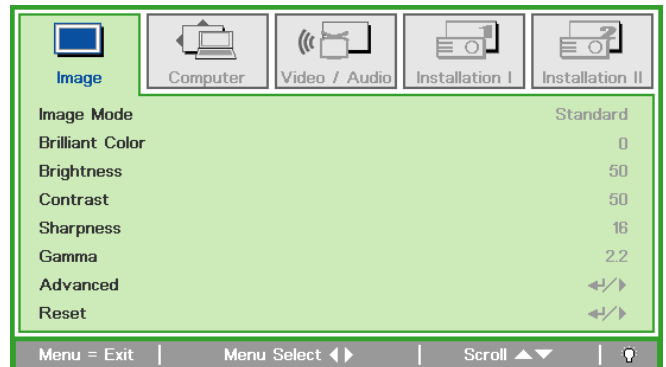

2. Press the cursor ◀▶ button to move to the **Installation I** menu.

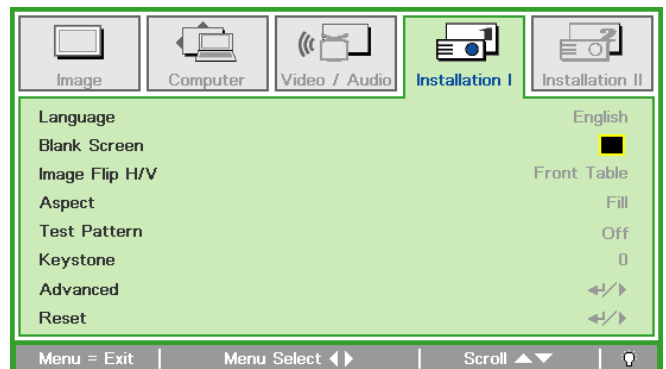

3. Press the cursor ▲▼ button to select **Advanced**.

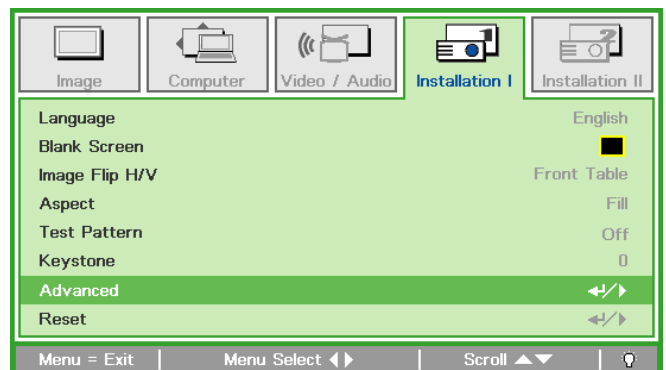

4. Press the cursor ▲▼ button to select **Security Lock**.

5. Press the cursor ◀▶ button to enable or disable security lock function.

A password dialog box automatically appears.

6. You can use the cursor buttons ▲▼◀▶ on IR remote control for password entry. You can use any combination including the same arrow five times, but not less than five.

Press the cursor buttons in any order to set the password. Push the **MENU** button to exit the dialog box.

7. The password confirm menu appears when user presses the power-on key in case the **Security Lock** is enabled. Enter the password in the order you set it at step 5. In case you forget the password, please contact the service center. Service center will validate the owner and help reset the password.

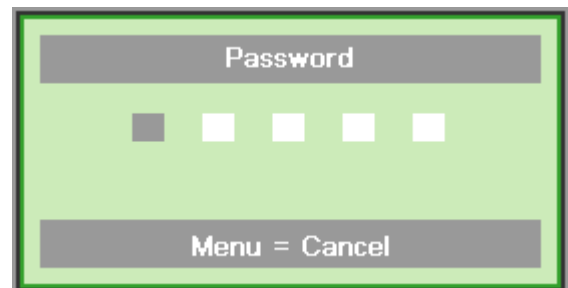
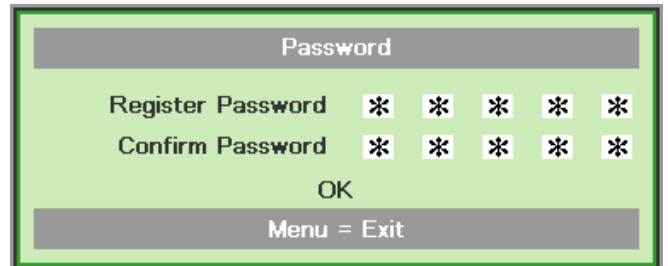
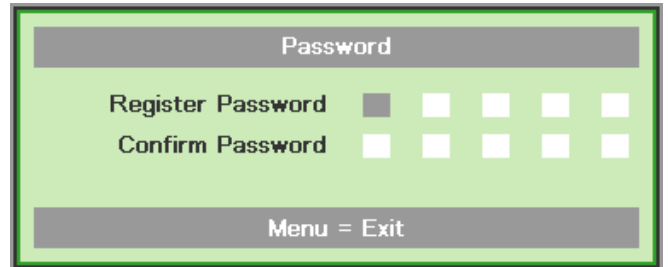
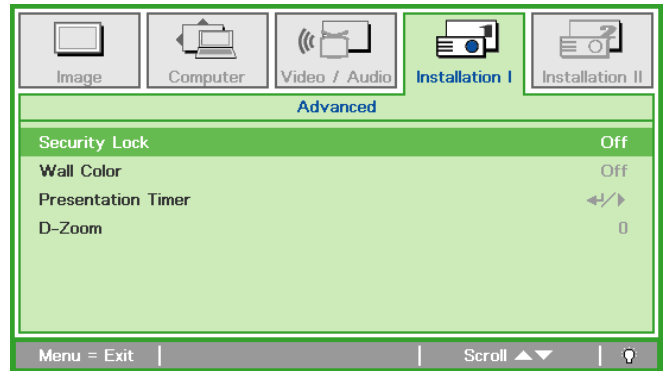

## Adjusting the Projector Level

Take note of the following when setting up the projector:

- *The projector table or stand should be level and sturdy.*
- *Position the projector so that it is perpendicular to the screen.*
- *Ensure the cables are in a safe location. You could trip over them.*

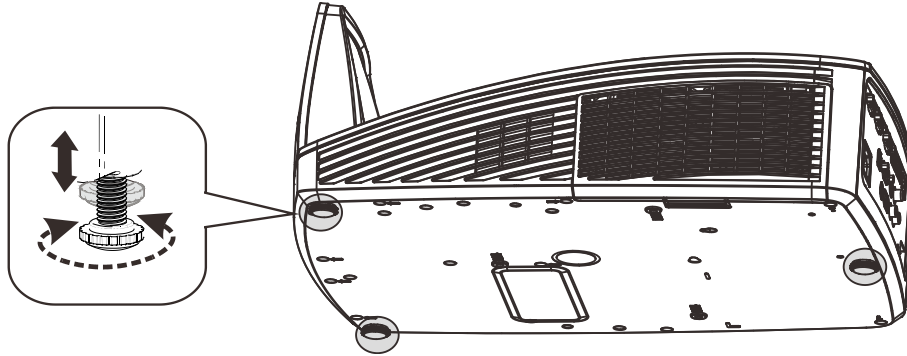

To adjust the angle of the picture, turn the tilt-adjuster right or left until the desired angle has been achieved.

## Adjusting the Focus and Keystone

1. Use the **Image-focus** control (on the projector only) to sharpen the projected image

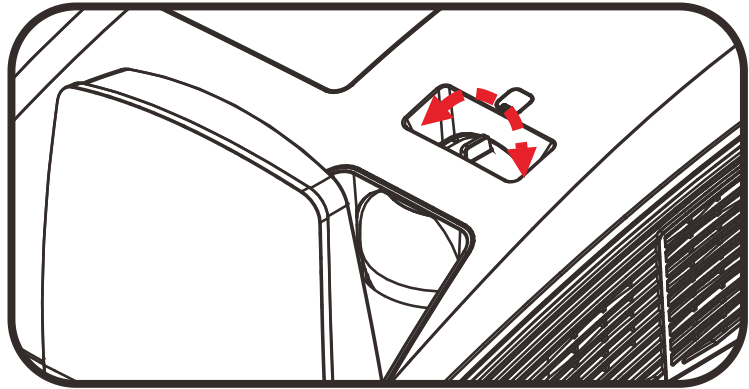

2. Use the **KEYSTONE** buttons on the remote control to correct keystone distortion (wider top or bottom) effect.

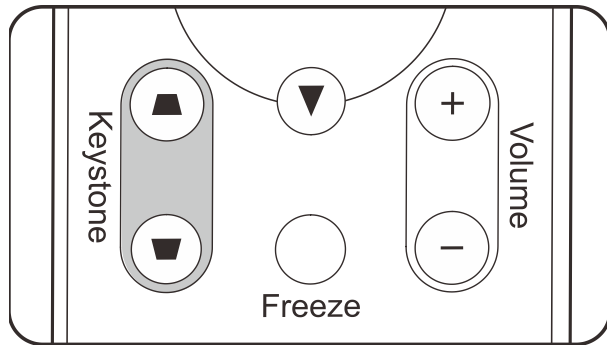

3. The keystone control appears on the display.



## Adjusting the Volume

1. Press the **Volume +/-** buttons on the remote control. The volume control appears on the display.

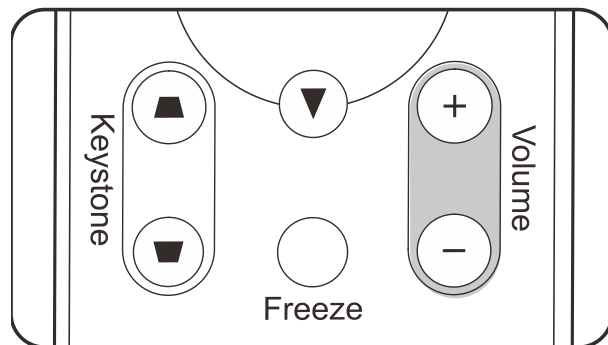

2. Press the **MUTE** button to turn off the volume. (This feature is available only on the remote).



# ON-SCREEN DISPLAY (OSD) MENU SETTINGS

## OSD Menu Controls

The projector has an OSD that lets you make image adjustments and change various settings.

### Navigating the OSD

You can use the remote control cursor buttons or the projector keypad to navigate and make changes to the OSD.

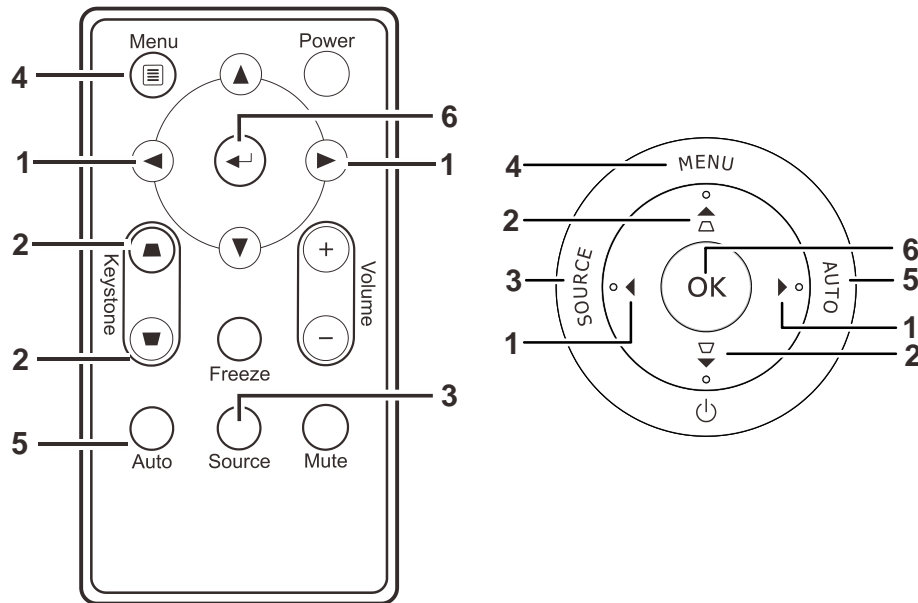

1. To enter the OSD, press the **MENU** button.
2. There are five menus. Press the cursor ◀▶ button to move through the menus.
3. Press the cursor ▲▼ button to move up and down in a menu.
4. Press ◀▶ to change values for settings.
5. Press **MENU** to close the OSD or leave a submenu.

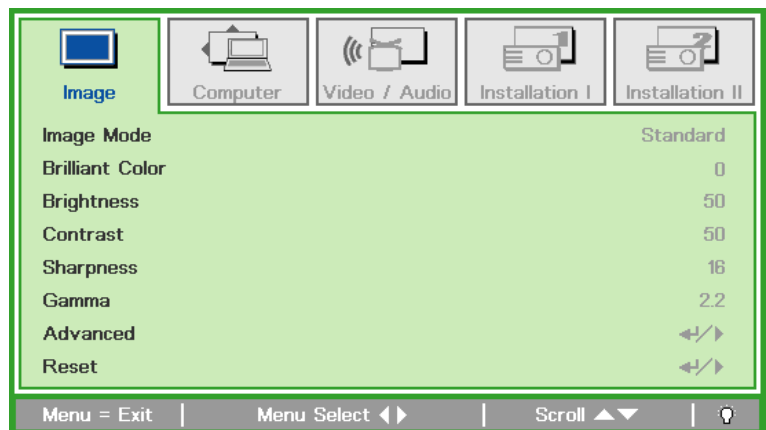

**Note:**

Depending on the source, not all items in the OSD are available. For example, the **Horizontal/Vertical Position** items in the **Computer** menu can only be modified when connected to a PC. Items that are not available cannot be accessed and are grayed out.

## Setting the OSD Language

Set the OSD language to your preference before continuing.

1. Press the **MENU** button. Press the cursor ◀▶ button to navigate to Installation I.

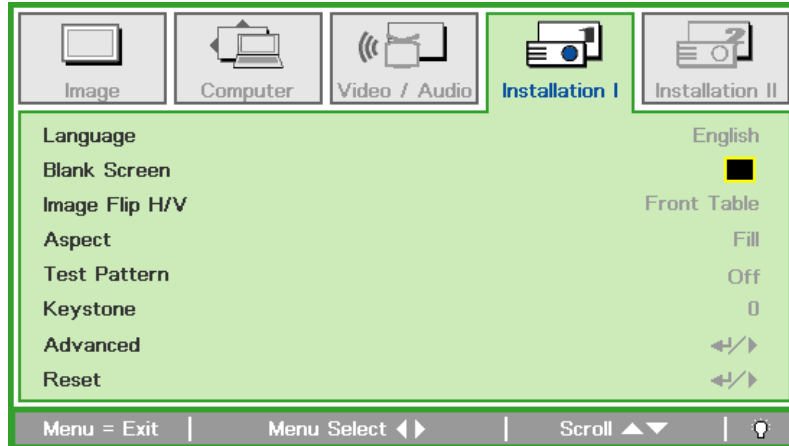

2. Press the cursor ▲▼ button until **Language** is highlighted.

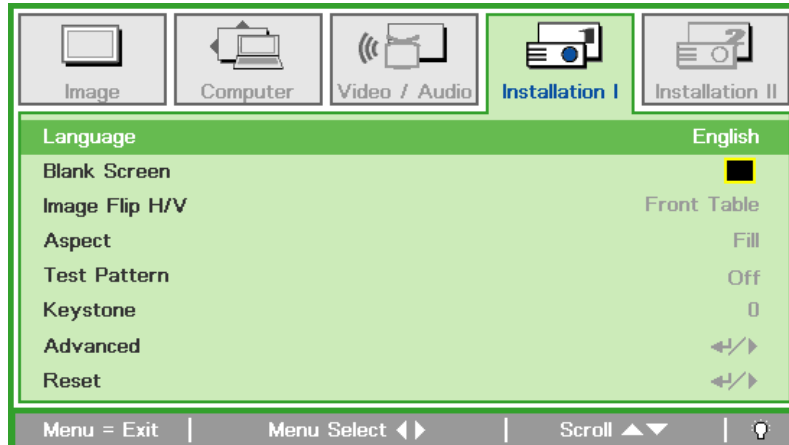

3. Press the cursor ◀▶ button until the language you want is highlighted.
4. Press the **MENU** button twice to close the OSD.



## OSD Menu Overview

Use the following illustration to quickly find a setting or determine the range for a setting.

| MAIN MENU     | SUB MENU            | SETTINGS                                  |                             |                       |
|---------------|---------------------|---|-----------------------------|-----------------------|
| Image         | Image Mode          | Standard, Presentation, sRGB, Movie, User |                             |                       |
|               | Brilliant Color     | 0~10                                      |                             |                       |
|               | Brightness          | 0~100                                     |                             |                       |
|               | Contrast            | 0~100                                     |                             |                       |
|               | Sharpness           | 0~31                                      |                             |                       |
|               | Gamma               | 2.0, 2.2, 2.4, 2.6, 2.8                   |                             |                       |
|               | Advanced            | Color Space                               | Auto, RGB, YUV              |                       |
|               |                     | Color Temperature                         | Native, 6500K, 7500K, 8200K |                       |
|               |                     | Color Manager                             | Red                         | Hue, Saturation, Gain |
|               |                     |   | Green                       | Hue, Saturation, Gain |
|               |                     |   | Blue                        | Hue, Saturation, Gain |
|               |                     |   | Cyan                        | Hue, Saturation, Gain |
|               |                     |   | Magenta                     | Hue, Saturation, Gain |
|               | Yellow              |   | Hue, Saturation, Gain       |                       |
| White         | Red, Green, Blue    |   |                             |                       |
| Reset         |                     |   |                             |                       |
| Computer      | Horizontal Position | -5~5                                      |                             |                       |
|               | Vertical Position   | -5~5                                      |                             |                       |
|               | Tracking            | 0~31                                      |                             |                       |
|               | Total Dots          | -5~5                                      |                             |                       |
|               | Auto PC             |   |                             |                       |
| Video / Audio | Video AGC           | Off, On                                   |                             |                       |
|               | Video Saturation    | 0~100                                     |                             |                       |
|               | Video Tint          | 0~100                                     |                             |                       |
|               | Film Mode           | Auto, Off                                 |                             |                       |
|               | Video Overscan      | Off, On                                   |                             |                       |
|               | Closed Captioning   | Off, On                                   |                             |                       |
|               | Audio               | Volume                                    | 0~8                         |                       |
|               |                     | Mute                                      | Off, On                     |                       |
| Reset         |                     |   |                             |                       |

| MAIN MENU      | SUB MENU       | SETTINGS  |  |         |
|----------------|----------------|---|--|---------|
| Installation I | Language       | English, Français, Deutsch, Español, Português, 簡體中文, 繁體中文, Italiano, Svenska, Nederlands, Русский, Suomi, 한국어, العربية, Türkçe, 日本語, Dansk, Polski, Magyar, Čeština, ไทย |  |         |
|                | Blank Screen   | Black, Red, Green, Blue, White  |  |         |
|                | Image Flip H/V | Front Table, Rear Table, Front Ceiling, Rear Ceiling  |  |         |
|                | Aspect         | Fill, 4:3, 16:9, Letter Box, Native   |  |         |
|                | Test Pattern   | Off, Cross Hatch, RGB Ramps, Color Bars, Stair Step, Checker, Horizontal Lines, Vertical Lines, Diagonal Lines, Horizontal Ramp, Vertical Ramp, White, Black              |  |         |
|                | Keystone       | -40~40  |  |         |
|                | Advanced       | Security Lock   | Off ,On  |         |
|                |                | Wall Color  | Off, Light Yellow, Pink, Light Green, Blue, Blackboard |         |
|                |                | Presentation Timer  | Timer  | Off ,On |
|                |                |   | Preset Time  | 1-60    |
|                |                |   | Timer Reset  |         |
|                | D-Zoom         | -10~10  |  |         |
|                | Reset          |   |  |         |

| MAIN MENU                           | SUB MENU              | SETTINGS                |                            |   |
|-------------------------------------|-----------------------|-------------------------|----------------------------|---|
| Installation II                     | Auto Search           | Off, On                 |                            |   |
|                                     | Auto Power Off (min.) | 0~180                   |                            |   |
|                                     | Direct Power On       | Off, On                 |                            |   |
|                                     | Fan Mode              | Normal, High Altitude   |                            |   |
|                                     | Lamp Mode             | Full Power, Power Saver |                            |   |
|                                     | Advanced              | OSD Menu Setting        | Menu Position              | Center, Down, Up, Left, Right   |
|                                     |                       |                         | Translucent Menu           | 0%, 25%, 50%, 75%, 100%   |
|                                     |                       |                         | Menu Display               | 10~20   |
|                                     |                       | Peripheral Test         | Remote Control Test        |   |
|                                     |                       |                         | Color Test                 |   |
|                                     |                       |                         | USB Test                   |   |
|                                     |                       | Reset Lamp Time         |                            |   |
|                                     |                       | Low Power Mode          | On, Off                    |   |
|                                     |                       | 3D                      | 3D                         | Off, DLP-Link, IR   |
|                                     |                       |                         | 3D Sync Invert             | On, Off   |
|                                     |                       |                         | 3D Format                  | Frame Sequential, Top/Bottom, Side-By-Side, Frame Packing (3D Frame Packing HDMI source only) |
|                                     |                       | RS232                   | RS232, Network             |   |
|                                     |                       | Network Setting         | Network State              | Disconnect, Connect   |
|                                     |                       |                         | DHCP                       | Off, On   |
|                                     |                       |                         | IP Address                 | 0~255, 0~255, 0~255, 0~255  |
|                                     | Subnet Mask           |                         | 0~255, 0~255, 0~255, 0~255 |   |
|                                     | Gateway               |                         | 0~255, 0~255, 0~255, 0~255 |   |
|                                     | DNS                   |                         | 0~255, 0~255, 0~255, 0~255 |   |
|                                     | Apply                 |                         | Cancel, OK                 |   |
|                                     | Factory Reset         |                         |                            |   |
|                                     | Status                | Active Source           |                            |   |
|                                     |                       | Video Information       |                            |   |
| Lamp Time (Power Saver, Full power) |                       |                         |                            |   |
| Firmware Version                    |                       |                         |                            |   |

## Image Menu

Press the **MENU** button to open the **OSD** menu. Press the cursor ◀▶ button to move to the **Image Menu**. Press the cursor ▲▼ button to move up and down in the **Image** menu. Press ◀▶ to change values for settings.

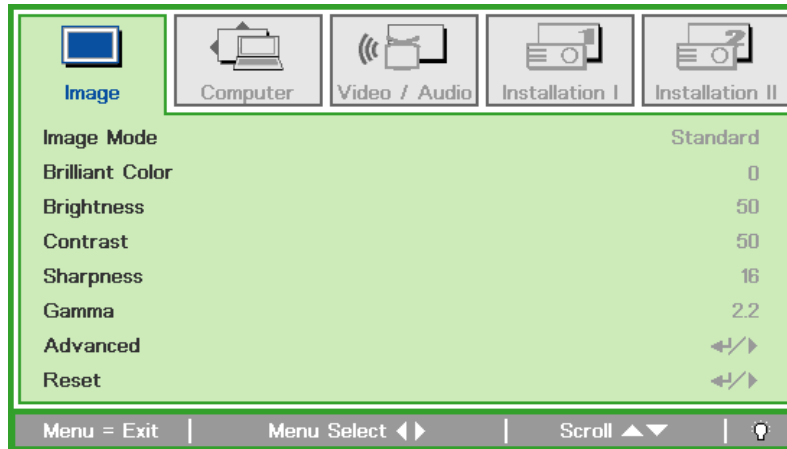

| ITEM            | DESCRIPTION   |
|-----------------|---|
| Image Mode      | Press the cursor ◀▶ button to set the Image Mode.   |
| Brilliant Color | Press the cursor ◀▶ button to adjust the Brilliant Color value.                           |
| Brightness      | Press the cursor ◀▶ button to adjust the display brightness.                              |
| Contrast        | Press the cursor ◀▶ button to adjust the display contrast.                                |
| Sharpness       | Press the cursor ◀▶ button to adjust the display sharpness level.                         |
| Gamma           | Press the cursor ◀▶ button to adjust the gamma correction of the display.                 |
| Advanced        | Press OK / ▶ to enter the Advanced menu. See <a href="#">Advanced Feature</a> on page 31. |
| Reset           | Press OK / ▶ to reset all settings to default values.                                     |

## Advanced Feature

Press the **Menu** button to open the **OSD** menu. Press ◀▶ to move to the **Image** menu. Press ▼▲ to move to the **Advanced** menu and then press **OK** or ▶. Press ▼▲ to move up and down in the **Advanced** menu.

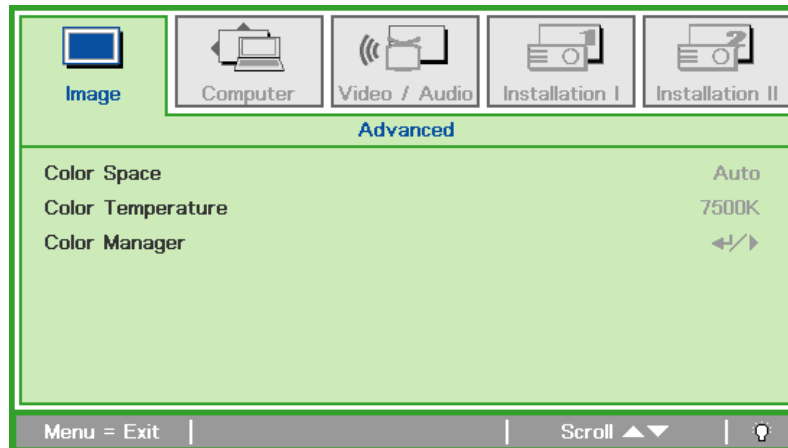

| ITEM              | DESCRIPTION  |
|-------------------|--|
| Color Space       | Press the cursor ◀▶ button to adjust the color space.  |
| Color Temperature | Press the cursor ◀▶ button to adjust the color temperature.  |
| Color Manager     | Press OK / ▶ to enter the color manager menu.<br>See page 32 for more information on <a href="#">Color Manager</a> . |

## Color Manager

Press OK / ► to enter the **Color Manager** sub menu.

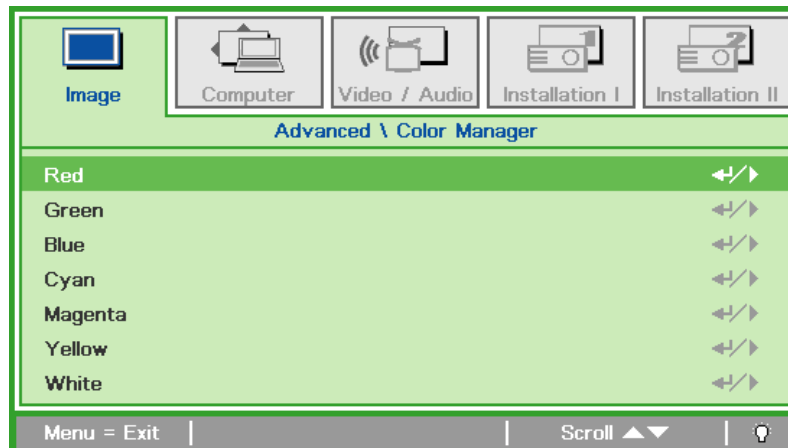

| ITEM    | DESCRIPTION   |
|---------|---|
| Red     | Select to enter the Red Color Manager.<br>Press the ◀▶ buttons to adjust the Hue, Saturation, and Gain.     |
| Green   | Select to enter the Green Color Manager.<br>Press the ◀▶ buttons to adjust the Hue, Saturation, and Gain.   |
| Blue    | Select to enter the Blue Color Manager.<br>Press the ◀▶ buttons to adjust the Hue, Saturation, and Gain.    |
| Cyan    | Select to enter the Cyan Color Manager.<br>Press the ◀▶ buttons to adjust the Hue, Saturation, and Gain.    |
| Magenta | Select to enter the Magenta Color Manager.<br>Press the ◀▶ buttons to adjust the Hue, Saturation, and Gain. |
| Yellow  | Select to enter the Yellow Color Manager.<br>Press the ◀▶ buttons to adjust the Hue, Saturation, and Gain.  |
| White   | Select to enter the White Color Manager.<br>Press the ◀▶ buttons to adjust the Red, Green, and Blue.        |

## Computer Menu

Press the **MENU** button to open the **OSD** menu. Press the cursor ◀▶ button to move to the **Computer** menu. Press the cursor ▲▼ button to move up and down in the computer menu. Press ◀▶ to change values for settings.

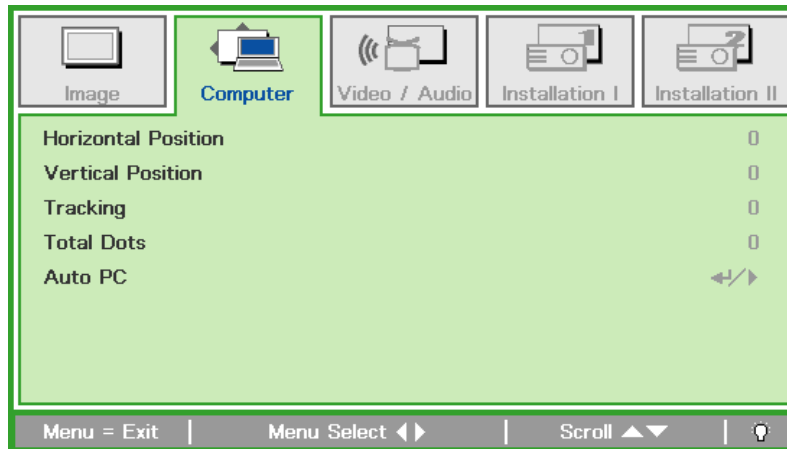

| ITEM                | DESCRIPTION  |
|---------------------|--|
| Horizontal Position | Press the cursor ◀▶ button to adjust the display position to left or right.      |
| Vertical Position   | Press the cursor ◀▶ button to adjust the display position to up or down.         |
| Tracking            | Press the cursor ◀▶ button to adjust the A/D sampling clock.                     |
| Total Dots          | Press the cursor ◀▶ button to adjust the A/D sampling dot.                       |
| Auto PC             | Press OK / ▶ to automatically adjustment for phase, tracking, size and position. |

## Video Menu

Press the **MENU** button to open the **OSD** menu. Press the cursor ◀▶ button to move to the **Video** menu. Press the cursor ▲▼ button to move up and down in the **Video** menu. Press ◀▶ to change values for settings.

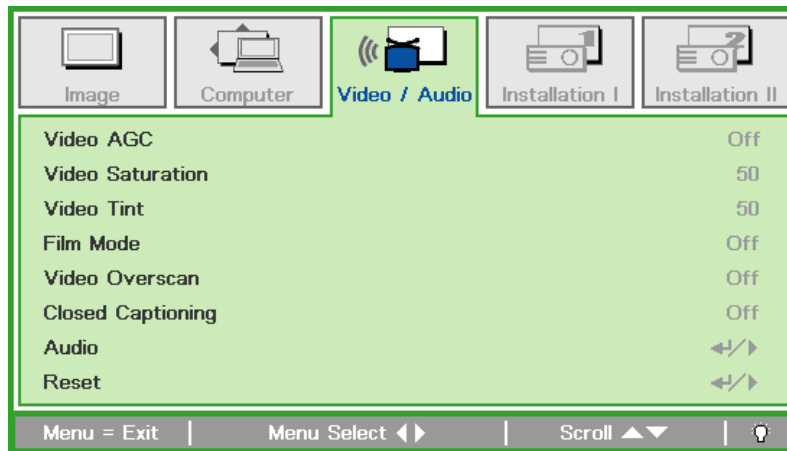

| ITEM              | DESCRIPTION  |
|-------------------|--|
| Video AGC         | Press the ◀▶ buttons to enable or disable the Automatic Gain Control for video source. |
| Video Saturation  | Press the ◀▶ buttons to adjust the video saturation.                                   |
| Video Tint        | Press the ◀▶ buttons to adjust the video tint/hue.                                     |
| Film Mode         | Press the ◀▶ buttons to select a different film mode.                                  |
| Video Overscan    | Press the ◀▶ buttons to enable or disable video over scan.                             |
| Closed Captioning | Press the ◀▶ buttons to enable or disable closed captioning.                           |
| Audio             | Press OK / ▶ to enter the Audio menu. See <a href="#">Audio</a> on page 35.            |
| Reset             | Press OK / ▶ to reset all settings to default values.                                  |

**Note:**

*Video jaggling may occur when playing interlace video. To overcome this issue, open the Video menu and adjust the Film Mode feature.*



## Audio

Press OK / ► to enter the **Audio** sub menu.

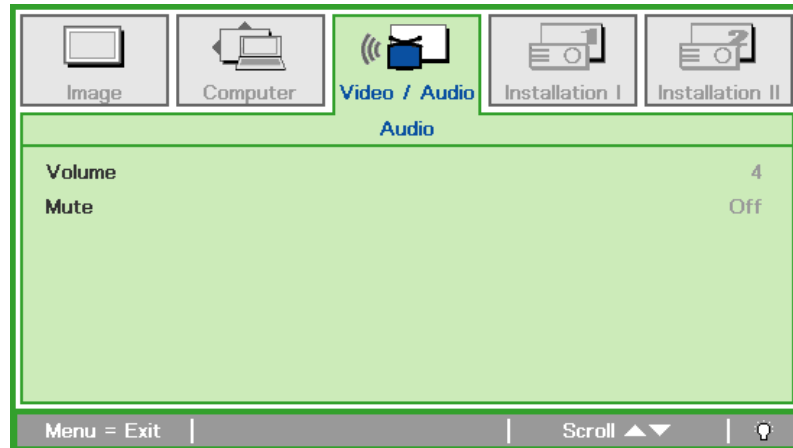

| ITEM   | DESCRIPTION   |
|--------|---|
| Volume | Press the ◀▶ buttons to enter and adjust the audio volume.    |
| Mute   | Press the ◀▶ buttons to enter and turn on or off the speaker. |

## Installation I Menu

Press the **MENU** button to open the **OSD** menu. Press the cursor ◀▶ button to move to the **Installation I** menu. Press the cursor ▲▼ button to move up and down in the **Installation I** menu. Press ◀▶ to change values for settings.

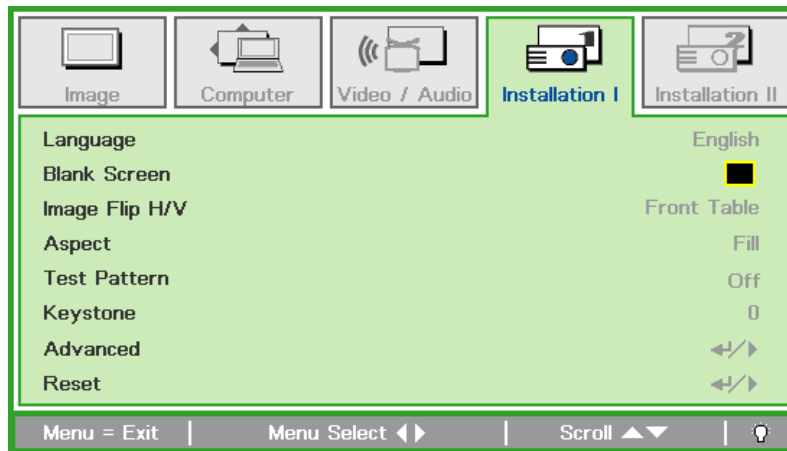

| ITEM           | DESCRIPTION   |
|----------------|---|
| Language       | Press the cursor ◀▶ button to select a different localization Menu.                 |
| Blank Screen   | Press the cursor ◀▶ button to select different color to blank the screen.           |
| Image Flip H/V | Press the cursor ◀▶ button to choose from four Image Flip H/V methods:              |
| Aspect         | Press the cursor ◀▶ button to adjust the video aspect ratio.                        |
| Test Pattern   | Press ◀▶ button to select different test pattern for projector installation check.  |
| Keystone       | Press the cursor ◀▶ button to adjust the display keystone.                          |
| Advanced       | Press OK / ▶ to the Advanced menu. See <a href="#">Advanced Feature</a> on page 37. |
| Reset          | Press OK / ▶ to reset all settings to default values (except Language).             |

## Advanced Feature

Press the **Menu** button to open the **OSD** menu. Press ◀▶ to move to the **Installation I** menu. Press ▲▼ to move to the **Advanced** menu and then press **OK** or ▶. Press ▲▼ to move up and down in the **Advanced** menu. Press ◀▶ to change values for setting.

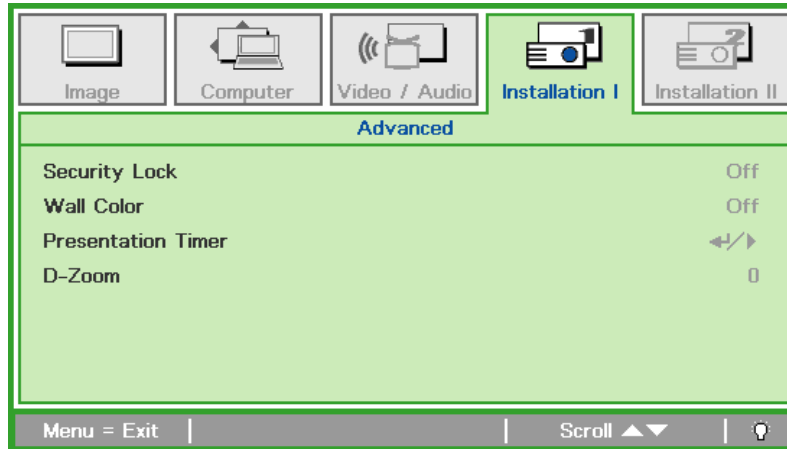

| ITEM               | DESCRIPTION  |
|--------------------|--|
| Security Lock      | Press the cursor ◀▶ button to enable or disable security lock function.                          |
| Wall Color         | Press the cursor ◀▶ button to enable or disable wall color function.                             |
| Presentation Timer | Press OK / ▶ to go to the Presentation Timer Menu. See <a href="#">Presentation Timer</a> below. |
| D-Zoom             | Press the cursor ◀▶ button to adjust the D-Zoom menu.  |

### *Presentation Timer*

The Presentation Timer function can indicate the presentation time on the screen to help you achieve better time management when giving presentations.

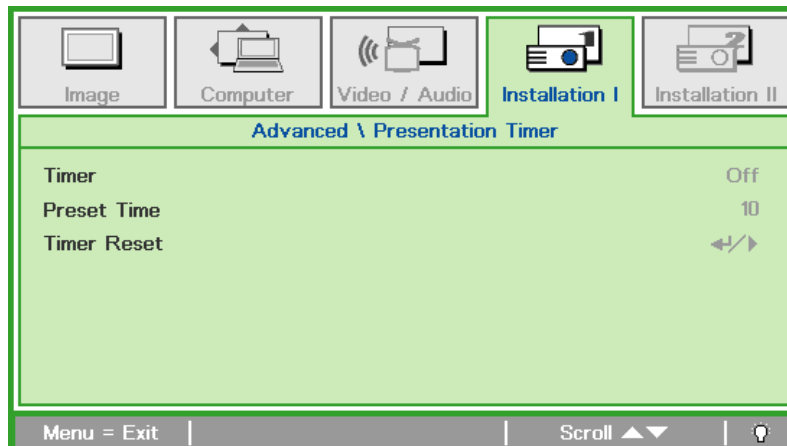

| ITEM        | DESCRIPTION   |
|-------------|---|
| Timer       | Press the cursor ◀▶ button to enable or disable presentation timer. |
| Preset Time | Press the cursor ◀▶ button to select Preset Time (1 ~ 60 minutes)   |
| Timer Reset | Press OK / ▶ to reset the timer settings.                           |

## Installation II Menu

Press the **MENU** button to open the **OSD** menu. Press the cursor ◀▶ button to move to the **Installation II** menu. Press the cursor ▲▼ button to move up and down in the Installation II menu.

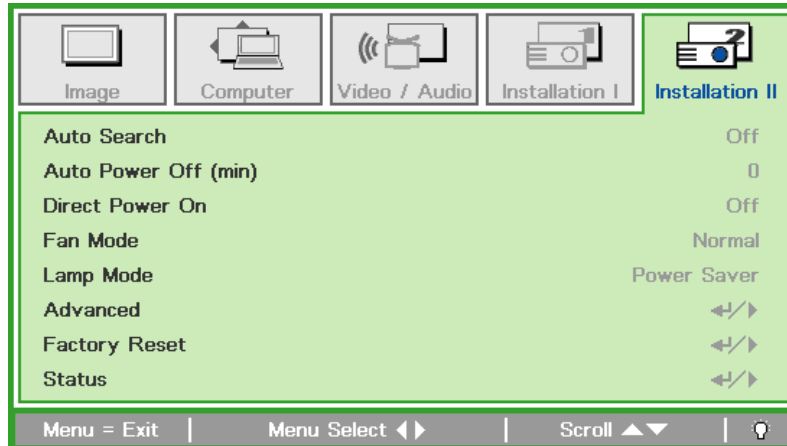

| ITEM                  | DESCRIPTION  |
|-----------------------|--|
| Auto Search           | Press the cursor ◀▶ button to enable or disable automatic source detection.  |
| Auto Power Off (min.) | Press the cursor ◀▶ button to enable or disable automatic shutdown of lamp when no signal.   |
| Direct Power On       | Press the cursor ◀▶ button to enable or disable automatic power On when AC power is supplied.  |
| Fan Mode              | Press the cursor ◀▶ button to toggle between Normal and High fan speeds.<br><b>Note:</b> Recommend selecting high speed when the altitude of the environment is higher than 1500m ( 4921ft ) |
| Lamp Mode             | Press the cursor ◀▶ button to select the lamp mode for higher brightness or lower brightness to save lamp life.  |
| Advanced              | Press OK / ▶ to enter the Advanced menu. See <a href="#">Advanced Feature</a> on page 39.  |
| Factory Reset         | Press OK / ▶ to reset all items to factory preset values.  |
| Status                | Press OK / ▶ to enter the Status menu. See page 51 for more information on <a href="#">Status</a> .  |

## Advanced Feature

Press the **Menu** button to open the **OSD** menu. Press ◀▶ to move to the **Installation II** menu. Press ▲▼ to move to the **Advanced** menu and then press **OK** or ▶. Press ▲▼ to move up and down in the **Advanced** menu. Press ◀▶ to change values for setting.

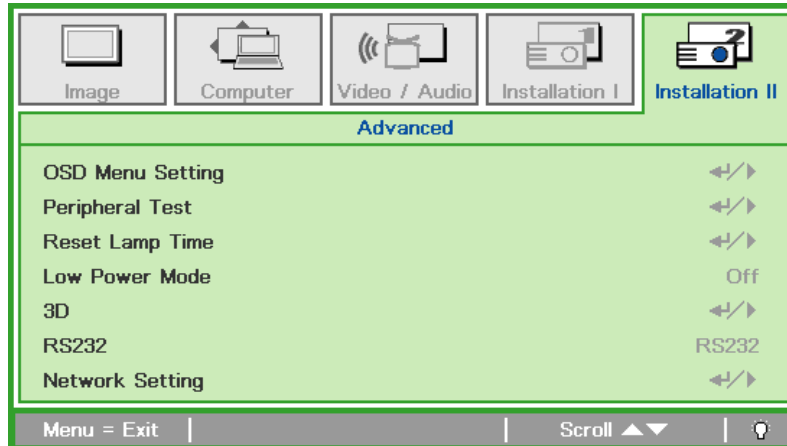

| ITEM             | DESCRIPTION  |
|------------------|--|
| OSD Menu Setting | Press OK / ▶ to enter the OSD setting menu. See page 40 for more information on <a href="#">OSD Menu Setting</a> .         |
| Peripheral Test  | Press OK / ▶ to enter the Peripheral Test menu. See page 40 for more information on <a href="#">Peripheral Test</a> .      |
| Reset Lamp Time  | After replacing the lamp, this item should be reset. See page 41 for more information on <a href="#">Reset Lamp Time</a> . |
| Low Power Mode   | Press ◀▶ to turn Low Power Mode on or off.   |
| 3D               | Press OK / ▶ to enter the 3D menu. See page 41 for more information on <a href="#">3D</a> settings.                        |
| RS232            | Press ◀▶ to select RS232 (remote) or Network (LAN) mode depending on projector connection method.                          |
| Network setting  | Press OK / ▶ to enter the Network menu. See page 42 for more information on <a href="#">Network Setting</a> .              |

**Note:**

*To enjoy the 3D function, first enable the Play Movie in 3D setting found in your DVD device under the 3D Disc Menu.*

*To enjoy Network function on Low Power Stand-By, Please let Low Power Mode set On, and RS232 set Network.*

## OSD Menu Setting

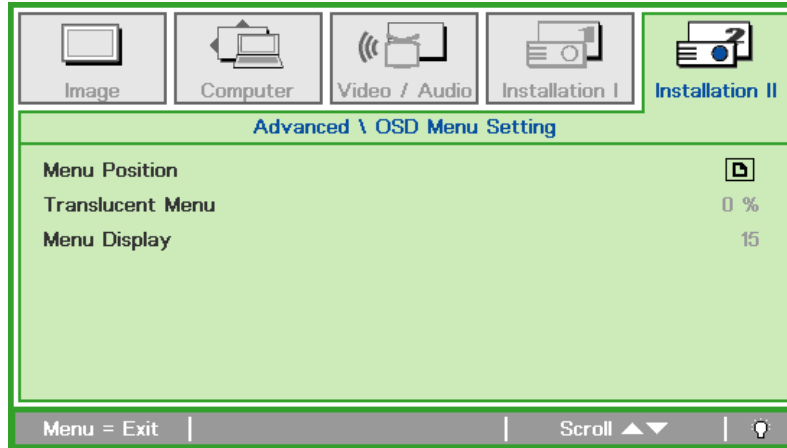

| ITEM             | DESCRIPTION   |
|------------------|---|
| Menu Position    | Press ◀▶ button to select different OSD location.           |
| Translucent Menu | Press ◀▶ button to select OSD background translucent level. |
| Menu Display     | Press ◀▶ button to select OSD timeout delay.                |

## Peripheral Test

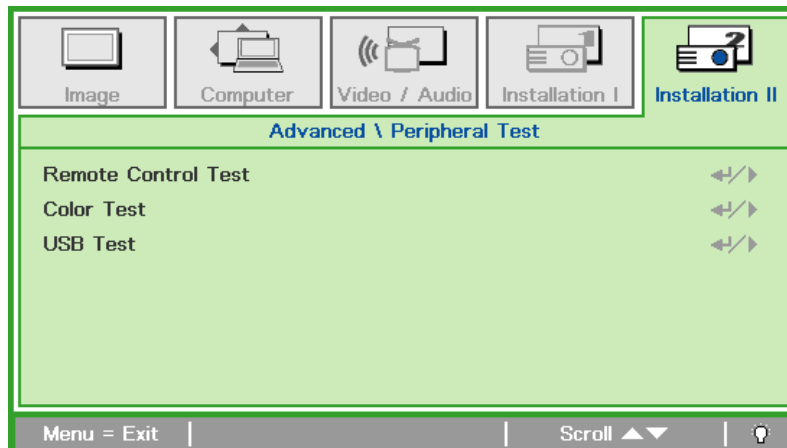

| ITEM                | DESCRIPTION   |
|---------------------|---|
| Remote Control Test | Press OK / ▶ to test the IR remote controller for diagnostic. |
| Color Test          | Press OK / ▶ to select different colors on screen.            |
| USB Test            | Press OK / ▶ to test the USB connection with connected PC.    |

## Reset Lamp Time

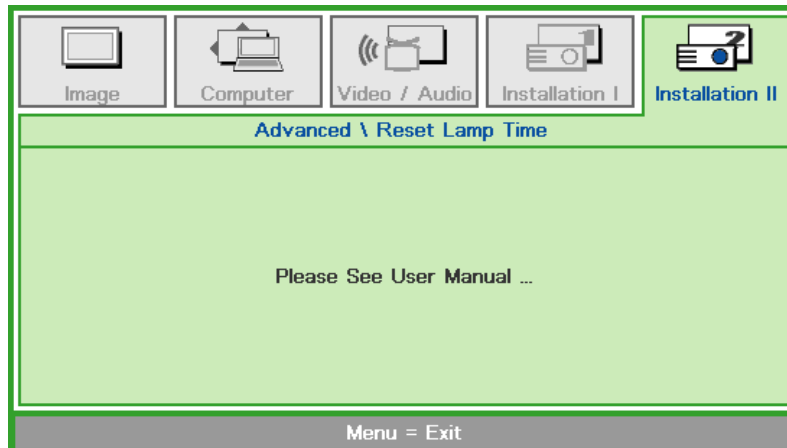

Please refer to [Resetting the Lamp](#) on page 54 to reset the lamp hour counter.

## 3D

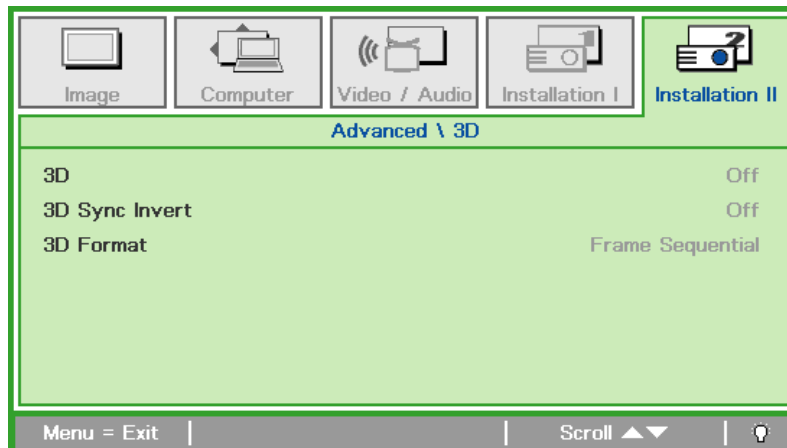

| ITEM           | DESCRIPTION                                |
|----------------|--|
| 3D             | Press ◀▶ to select Off, DLP-Link or IR.    |
| 3D Sync Invert | Press ◀▶ to turn 3D Sync Invert On or Off. |
| 3D Format      | Press ◀▶ to enable or disable 3D Format.   |

## Network Setting

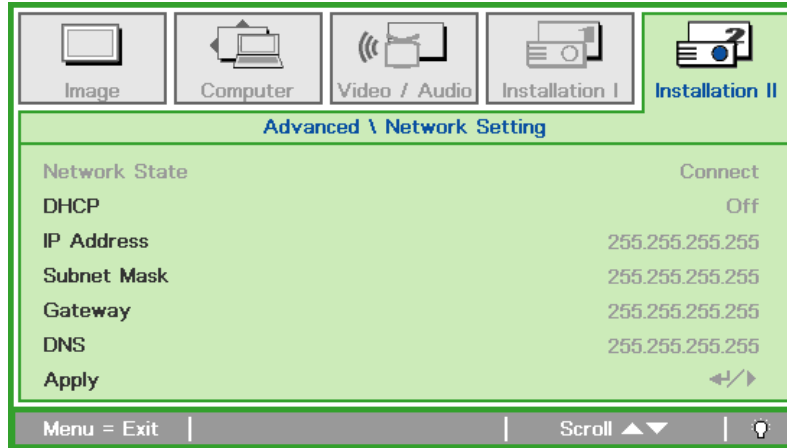

| ITEM          | DESCRIPTION   |
|---------------|---|
| Network State | Displays the network connection status.   |
| DHCP          | Press ◀▶ to turn DHCP On or Off.<br><b>Note:</b> If you select DHCP Off, complete the IP Address, Subnet Mask, Gateway, and DNS fields. |
| IP Address    | Enter a valid IP address if DHCP is turned off.   |
| Subnet Mask   | Enter a valid Subnet Mask if DHCP is turned off.  |
| Gateway       | Enter a valid Gateway address if DHCP is turned off.  |
| DNS           | Enter a valid DNS name if DHCP is turned off.   |
| Apply         | Press OK / ▶ to confirm settings.   |



For simplicity and ease of operation, the projector provides diverse networking and remote management features.

The LAN/RJ45 function of the projector through a network, such as remotely manage: Power On/Off, Brightness and Contrast settings. Also, projector status information, such as: Video-Source, Sound-Mute, etc.

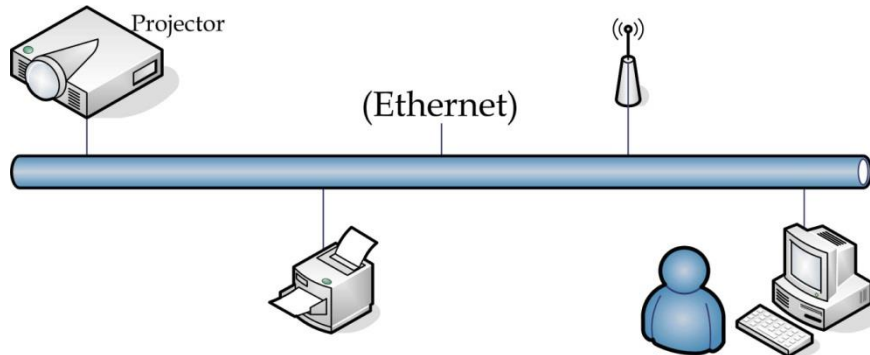

The projector can be controlled by a PC (Laptop) or other external device with connecting to the projector's LAN/RJ45 port.

#### Wired LAN Terminal functionalities

Remote control and monitoring of a projector from a PC (or Laptop) via wired LAN is also possible. Compatibility with Crestron / AMX (Device Discovery) / Extron control boxes enables not only collective projector management on a network but also management from a control panel on a PC (or Laptop) browser screen.

- \* Crestron is a registered trademark of Crestron Electronics, Inc. of the United States.
- \* Extron is a registered trademark of Extron Electronics, Inc. of the United States.
- \* AMX is a registered trademark of AMX LLC of the United States.

#### Supported External Devices

This projector is supported by the specified commands of the Crestron Electronics controller and related software (ex, RoomView ®).

<http://www.crestron.com/>

This projector is supported by AMX ( Device Discovery ).

<http://www.amx.com/>

This projector is compliant to support Extron device(s) for reference.

<http://www.extron.com/>

## LAN RJ45

1. Connect an RJ45 cable to RJ45 ports on the projector and the PC (Laptop).

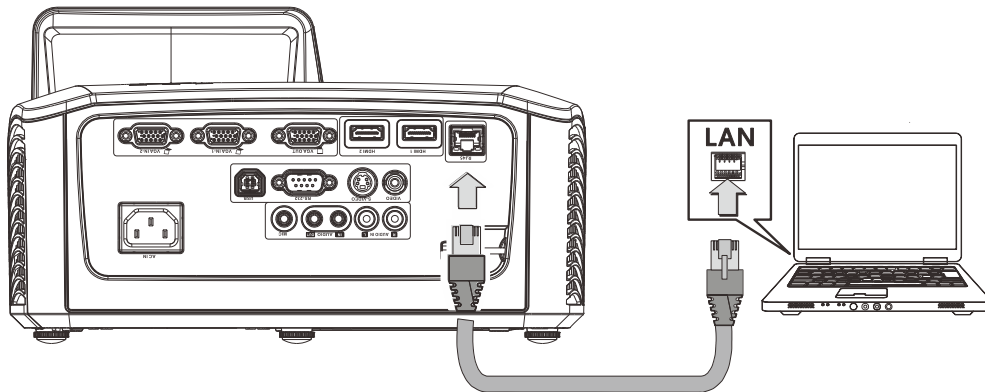

2. On the PC (Laptop), select **Start** → **Control Panel** → **Network and Internet**.

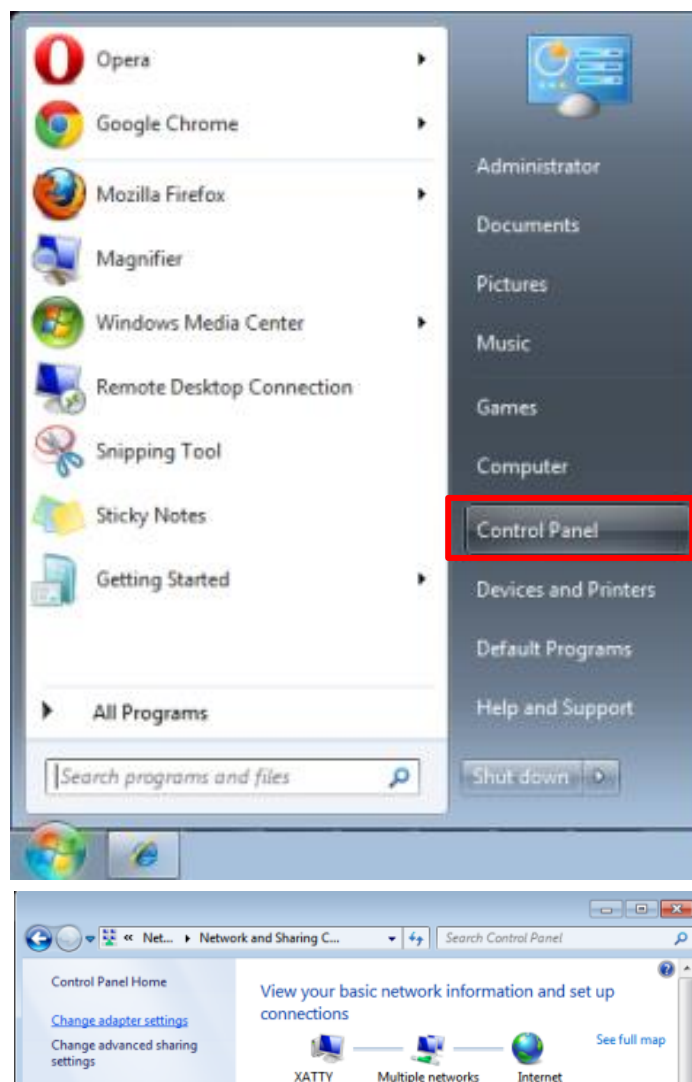

3. Right-click on **Local Area Connection**, and select **Properties**.

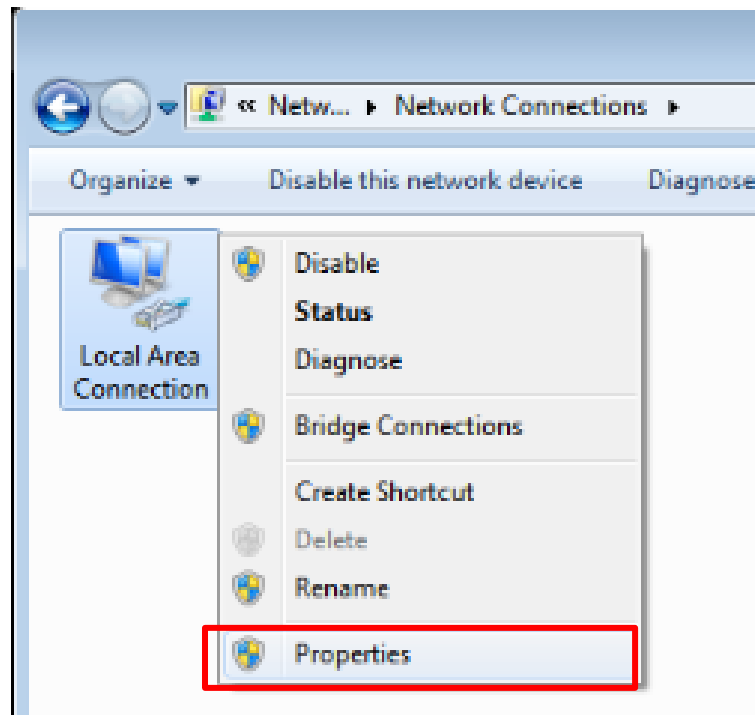

4. In the **Properties** window, select the **Networking** tab, and select **Internet Protocol (TCP/IP)**.
5. Click **Properties**.

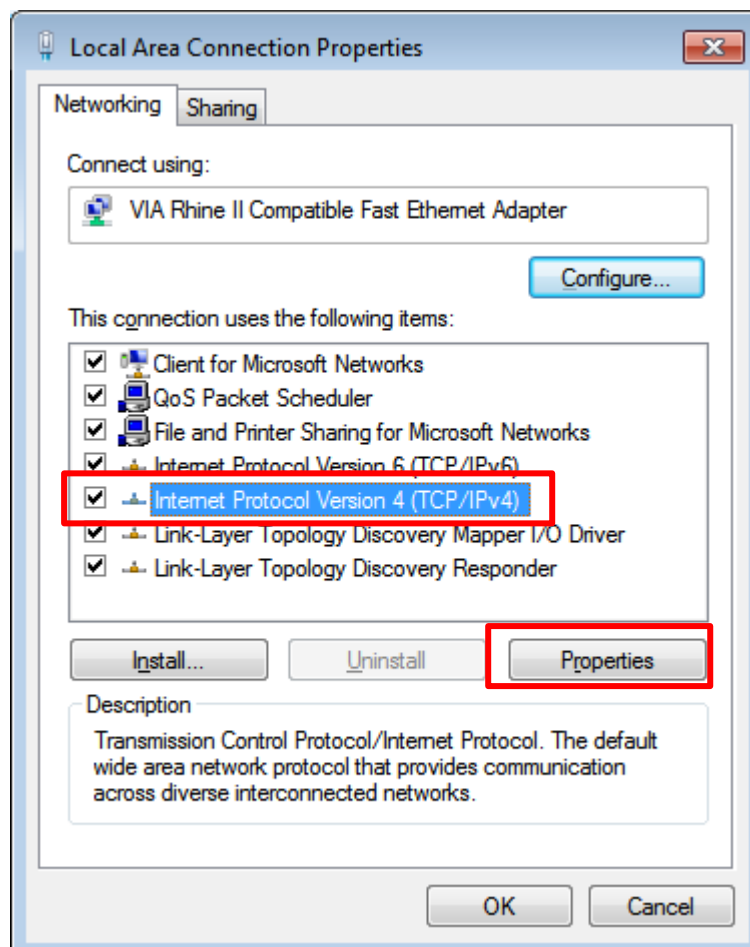

6. Click **Use the following IP address** and fill in the IP address and Subnet mask, then click **OK**.

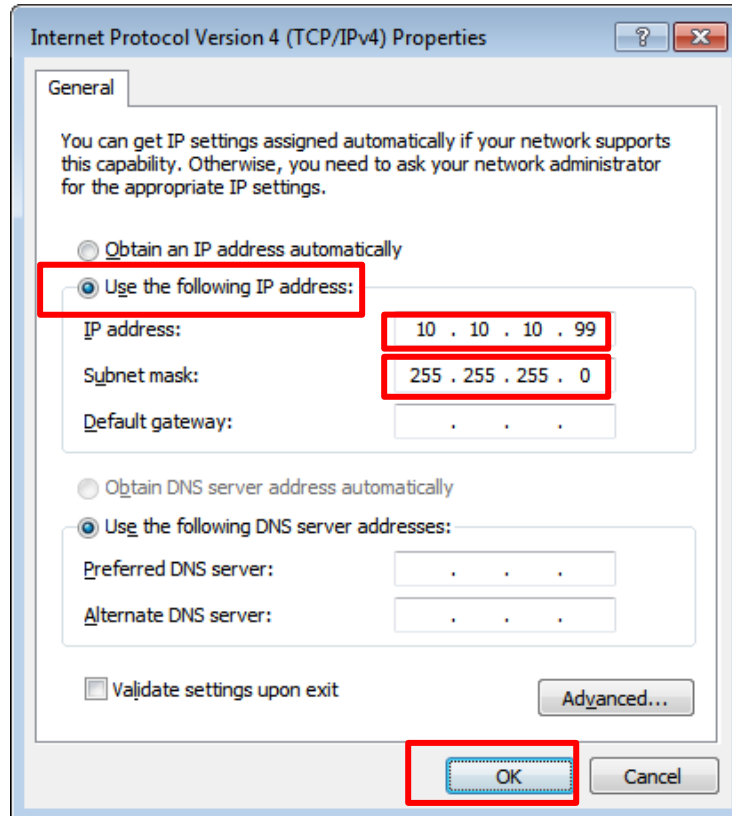

7. Press the **Menu** button on the projector.
8. Select **Installation II** → **Advanced** → **Network Setting** → **Network State** → **Connect**
9. After getting into **Network Setting**, input the following:
- ▶ DHCP: Off
  - ▶ IP Address: 10. 10. 10. 10
  - ▶ Subnet Mask: 255.255.255.0
  - ▶ Gateway: 0.0.0.0
  - ▶ DNS Server: 0.0.0.0
10. Press OK / ▶ to confirm settings.
11. Open a web browser (for example, Microsoft Internet Explorer with Adobe Flash Player 9.0 or higher).

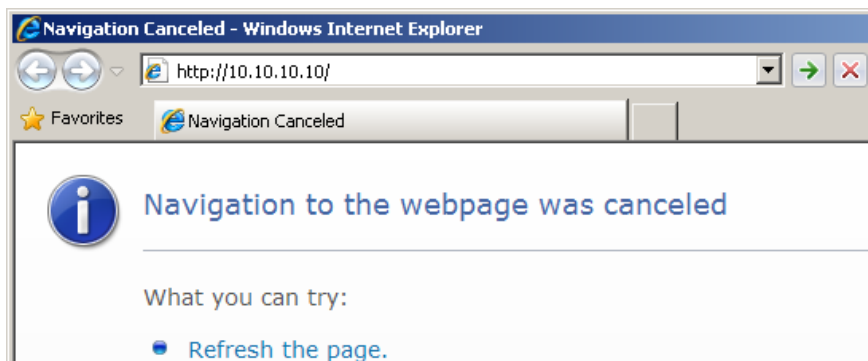

12. In the Address bar, input the IP address: 10. 10. 10. 10.
13. Press OK / ▶.

The projector is setup for remote management. The LAN/RJ45 function displays as follows. Based on network web-page for the input-string in **tools** tab, the limitation for Input-Length is in the below list (“space” and the other punctuation key included):



**CRESTRON** Expansion Options

|   |  |  |
|---|--|--|
| <p><b>Crestron Control</b></p> <p>IP Address: <input type="text" value="192.168.0.20"/></p> <p>IP ID: <input type="text" value="03"/></p> <p>Port: <input type="text" value="41794"/></p> <p style="text-align: right;"><input type="button" value="Send"/></p> | <p><b>Projector</b></p> <p>Projector Name: <input type="text" value="A01"/></p> <p>Location: <input type="text" value="Room"/></p> <p>Assigned To: <input type="text" value="Sir."/></p> <p style="text-align: right;"><input type="button" value="Send"/></p> <p>DHCP: <input type="checkbox"/> Enabled</p> <p>IP Address: <input type="text" value="10.10.10.10"/></p> <p>Subnet Mask: <input type="text" value="255.255.255.0"/></p> <p>Default Gateway: <input type="text" value="0.0.0.0"/></p> <p>DNS Server: <input type="text" value="0.0.0.0"/></p> <p style="text-align: right;"><input type="button" value="Send"/></p> | <p><b>User Password</b></p> <p><input type="checkbox"/> Enabled</p> <p>New Password: <input type="text"/></p> <p>Confirm: <input type="text"/></p> <p style="text-align: right;"><input type="button" value="Send"/></p> <p><b>Admin Password</b></p> <p><input type="checkbox"/> Enabled</p> <p>New Password: <input type="text"/></p> <p>Confirm: <input type="text"/></p> <p style="text-align: right;"><input type="button" value="Send"/></p> |
| <input type="button" value="Exit"/>   |  |  |

| CATEGORY              | ITEM            | INPUT-LENGTH |
|-----------------------|-----------------|--------------|
| Crestron Control      | IP Address      | 15           |
|                       | IP ID           | 3            |
|                       | Port            | 5            |
| Projector             | Projector Name  | 10           |
|                       | Location        | 10           |
|                       | Assigned To     | 10           |
| Network Configuration | DHCP (Enabled)  | (N/A)        |
|                       | IP Address      | 15           |
|                       | Subnet Mask     | 15           |
|                       | Default Gateway | 15           |
|                       | DNS Server      | 15           |
| User Password         | Enabled         | (N/A)        |
|                       | New Password    | 10           |
|                       | Confirm         | 10           |
| Admin Password        | Enabled         | (N/A)        |
|                       | New Password    | 10           |
|                       | Confirm         | 10           |

For more information, please visit <http://www.crestron.com/>.

## RS232 by Telnet Function

Besides projector connected to RS232 interface with “Hyper-Terminal” communication by dedicated RS232 command control, there is alternative RS232 command control way, so called “RS232 by TELNET” for LAN/RJ45 interface.

### Quick Start-Guide for “RS232 by TELNET”

Check and get the IP-Address on OSD of the projector.

Make sure that laptop/PC can access the web-page of the projector.

Make sure that “Windows Firewall” setting to be disabled in case of “TELNET” function filtering out by laptop/PC.

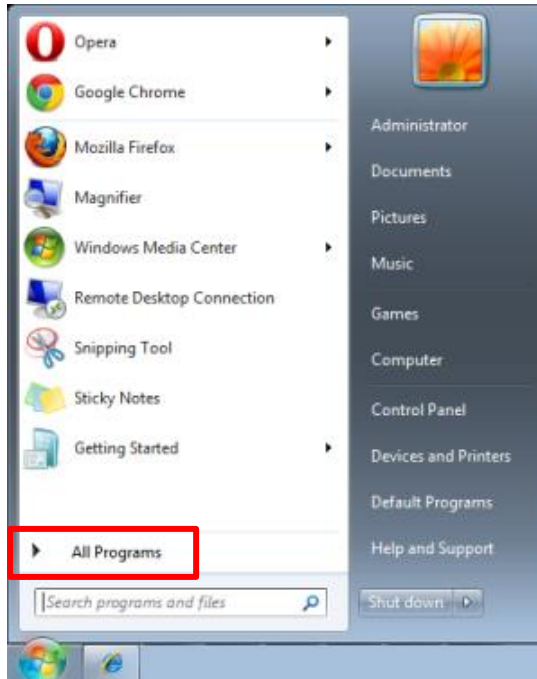

Start => All Programs => Accessories => Command Prompt

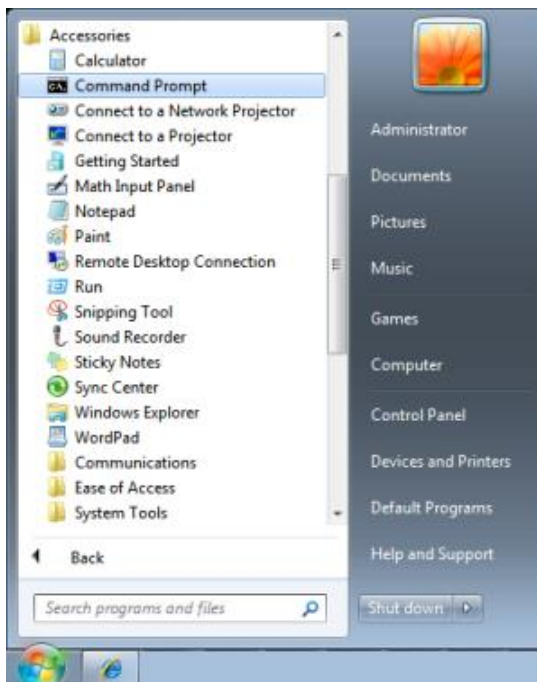

Input the command format like the below:

**telnet ttt.xxx.yyy.zzz 23** (“Enter” key pressed)

(**ttt.xxx.yyy.zzz**: IP-Address of the projector)

If Telnet-Connection ready, and user can have RS232 command input, then “Enter” key pressed, the RS232 command will be workable.

## How to have TELNET enabled in Windows VISTA / 7

By default installation for Windows VISTA, “TELNET” function is not included. But end-user can have it by way of “Turn Windows features On or Off” to be enabled.

Open “Control Panel” in Windows VISTA

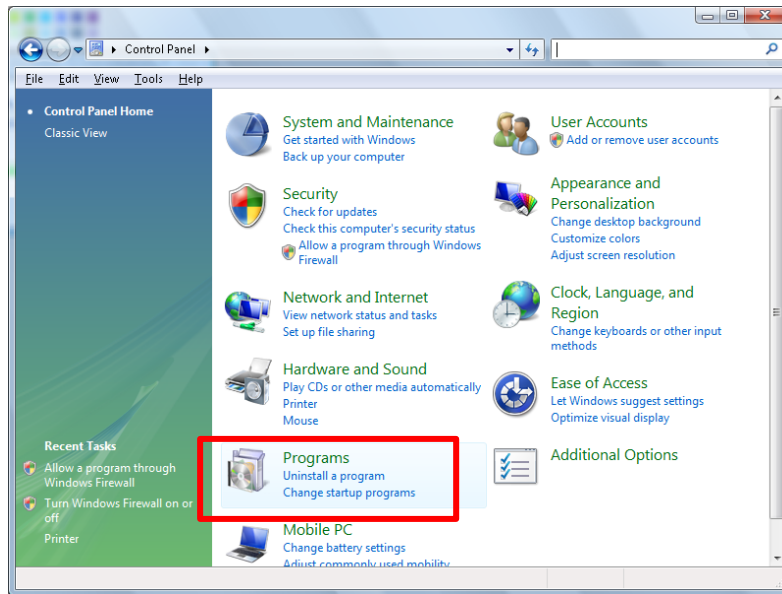

Open “Programs”

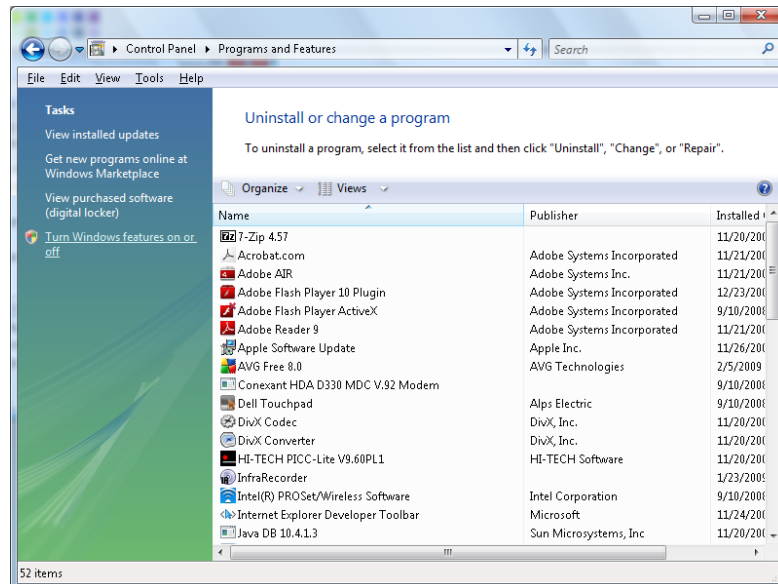

Select “Turn Windows features on or off” to open

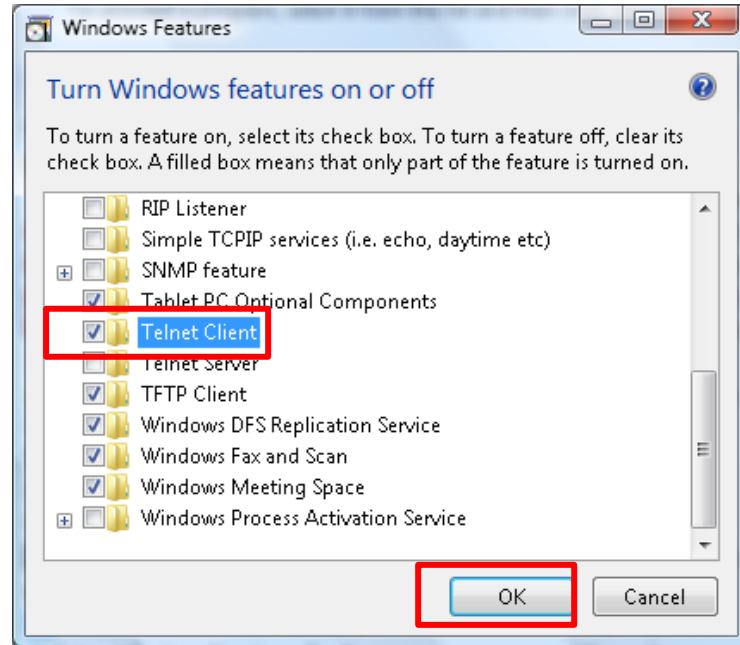

Have “Telnet Client” option checked, then press “OK” button.

### Specsheet for “RS232 by TELNET” :

1. Telnet: TCP
2. Telnet port: 23
3. Telnet utility: Windows “TELNET.exe” (console mode)
4. Disconnection for RS232-by-Telnet control normally: Close Windows Telnet utility directly after TELNET connection ready
5. Limitation 1 for Telnet-Control: there is only one connection for Telnet-Control in one projector  
Limitation 2 for Telnet-Control: there is less than 50 bytes for successive network payload for Telnet-Control application.

Limitation 3 for Telnet-Control: there is less than 26 bytes for one complete RS232 command for Telnet-Control.

Limitation 4 for Telnet-Control: Minimum delay for next RS232 command must be more than 200 (ms).

(\* In Windows built-in “TELNET.exe” utility, “Enter” key pressed will have “Carriage-Return” and “New-Line” code.)



## Factory Reset

Press the cursor ▲▼ button to move up and down in the **Installation II** menu. Select the **Factory Reset** sub menu and press OK / ► to reset all the menu items to the factory default values (except Language and Security Lock).

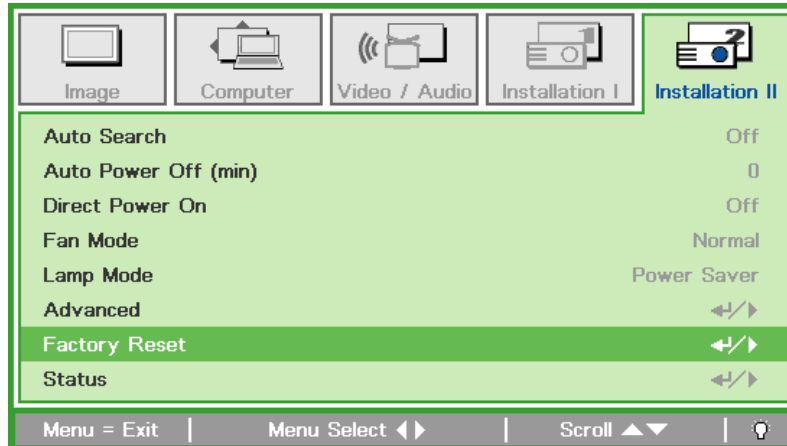

## Status

Press the cursor ▲▼ button to move up and down in the **Installation II** menu. Select the **Status** sub menu and press OK / ► to enter the **Status** sub menu.

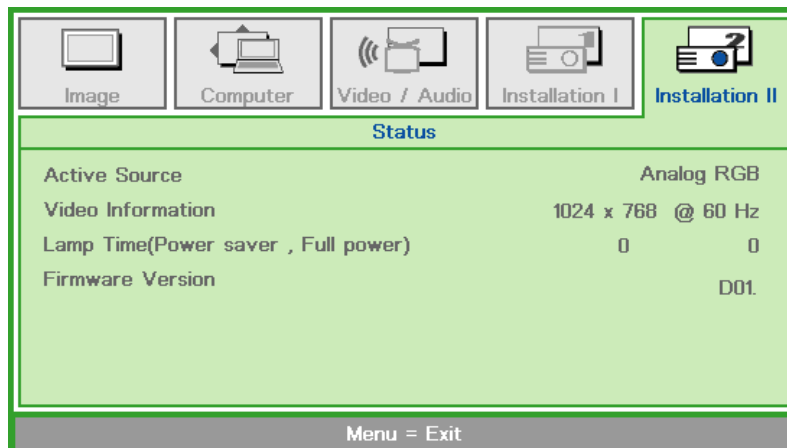

| ITEM                                | DESCRIPTION   |
|-------------------------------------|---|
| Active Source                       | Display the activated source.   |
| Video Information                   | Displays resolution/video information for RGB source and color standard for Video source. |
| Lamp Time (Power Saver, Full power) | Lamp Time used information is displayed.  |
| Firmware Version                    | Showing system Firmware version.  |

### Replacing the Projection Lamp

The projection lamp should be replaced when it burns out. It should only be replaced with a certified replacement part, which you can order from your local dealer. parts No.LV-LP41



#### **Warning:**

- *If illumination suddenly stops, either when you turn the projector on or after it has been on for a while, the lamp may have ruptured. In this case, never attempt to replace the lamp by yourself. Always request service from the Canon Customer Support Center. Additionally, with ceiling-mounted projectors, the lamp may fall out when you open the lamp cover or while you are attempting to replace it.*
- *During replacement, stand to the side of the lamp cover, not directly under it. If the lamp ruptures and you accidentally inhale or get pieces in your eyes or mouth, consult a doctor immediately.*
- *If the lamp ruptures, dust and gas (containing mercury vapor) may come out of the exhaust vents. If this happens, immediately open the windows and doors to provide ventilation to the room. If you inhale any gas emitted from the lamp or it has come into contact with your eyes or mouth, consult a doctor immediately.*



#### **Caution:**

*When replacing the lamp, turn off the projector, wait until the cooling fan stops, disconnect the power plug from the electrical outlet, and let the projector stand for at least 45minutes. Otherwise, you may get burned because the main unit is very hot immediately after the projector is turned off.*

#### **Caution:**

- *Be sure to use the specified lamp.*
- *Contact the Canon Customer Support Center for further information. This can also be purchased from the Canon website.*
- *Do not touch the inner glass surface when you replace the lamp. Doing so may cause deterioration to the projector's performance.*
- *Be sure to handle the lamp carefully and correctly since it may break during use if it has been scratched or subjected to impact. If the lamp ruptures, contact the Canon Customer Support Center.*
- *When replacing the lamp, do not remove any screws other than those specified.*

- 1.** Remove the single screw on the lamp compartment cover.

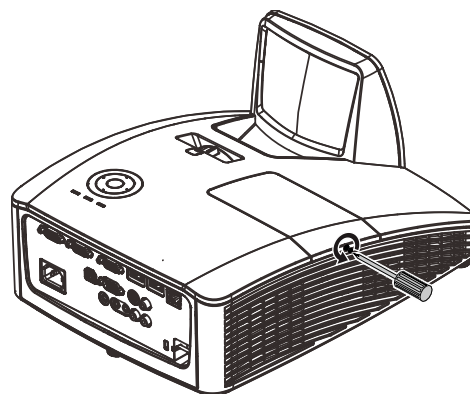

2. Remove the lamp compartment cover.

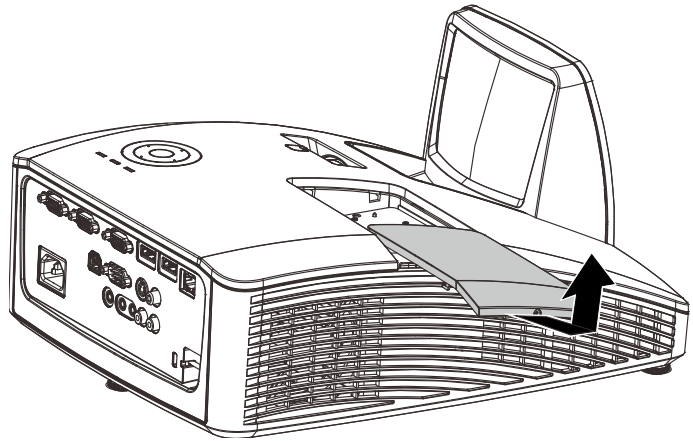

3. Loosen the two screws securing the lamp.

4. Lift the module handle up.

5. Pull firmly on the module handle to remove the lamp.

6. Reverse steps 1 to 5 to install the new lamp. While installing, align the lamp module with the connector and ensure it is level to avoid damage.

**Note:** The lamp must sit securely in place and the lamp connector must be connected properly before tightening the screws.

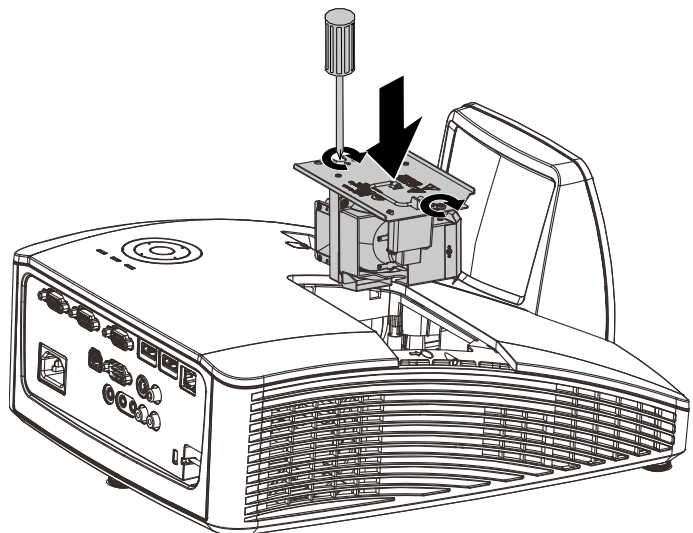
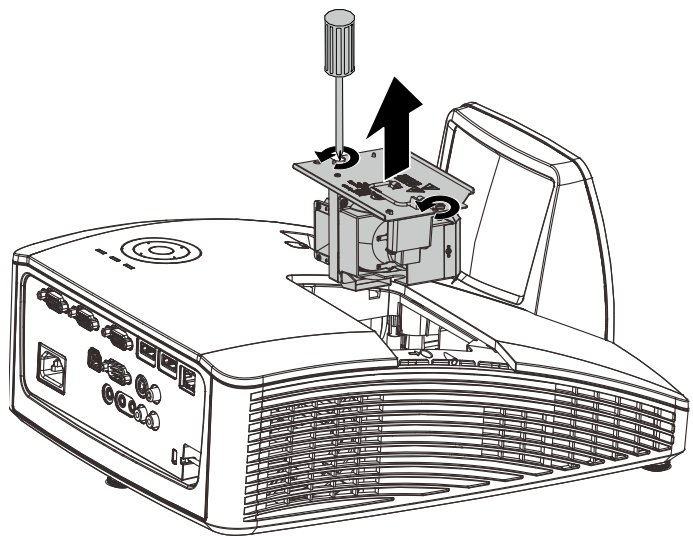

## Resetting the Lamp Time

After replacing the lamp, you should reset the lamp hour counter to zero. Refer to the following:

1. Press the **MENU** button to open the OSD menu.
2. Press the cursor **◀▶** button to move to the **Installation II** menu. Press the cursor button to move down to **Advanced**.
3. Press the cursor **▼▲** button to move down to **Reset Lamp Time**.
4. Press the cursor **▶** or Enter button.  
  
A message screen appears.
5. Press **▼▲◀▶** buttons to reset the lamp hour.
6. Press the **MENU** button to get back to Installation II.

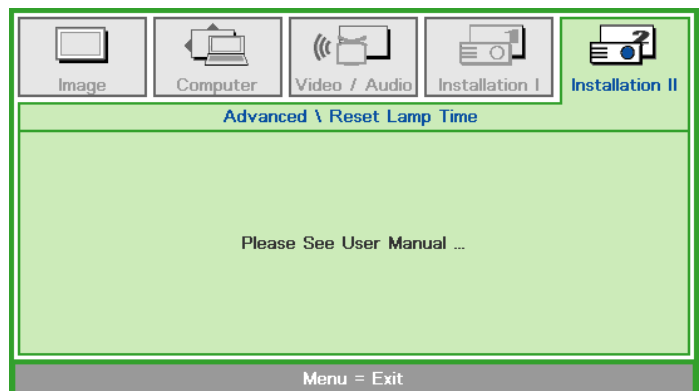
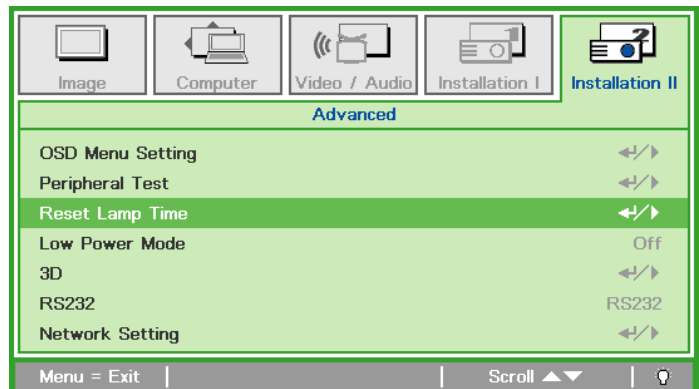
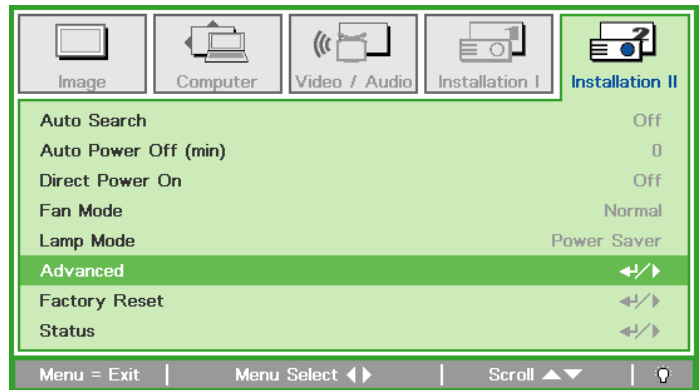

## Cleaning the Projector

Cleaning the projector to remove dust and grime will help ensure trouble-free operation.

### Cleaning the Projector Mirror:

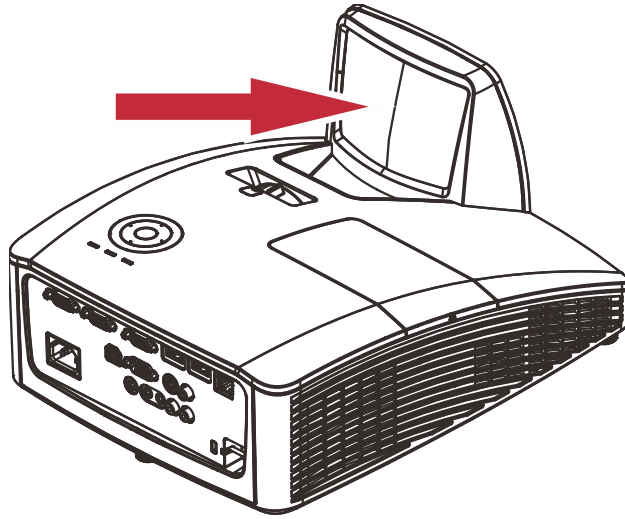

When cleaning the projector's lens, use a commonly available air blower or lens cleaning paper. The lens surface is easily damaged, so do not use a hard cloth or tissues.



**Caution:**

1. Always turn the projector off and allow to cool for at least 30 minutes prior to cleaning.

**Caution:**

1. Never touch the projector mirror or Lens directly by hand.

2. Do not use abrasive cleaners, solvents or other harsh chemical cleaners.

## Using the Physical Lock

### Using the Kensington® Lock

If you are concerned about security, attach the projector to a permanent object with the Kensington slot and a security cable.

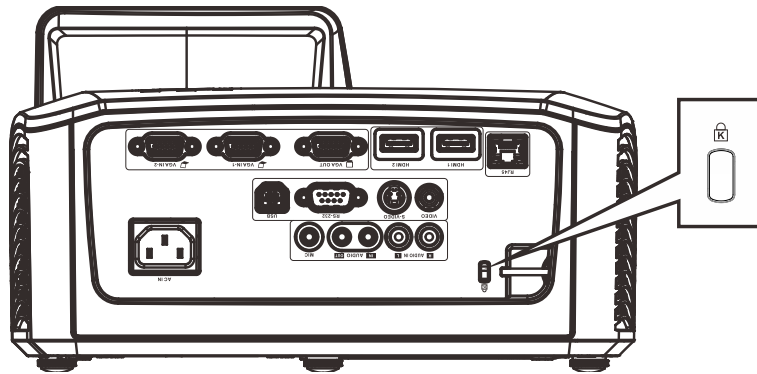

**Note:**

Contact your vendor for details on purchasing a suitable Kensington security cable.

### Using the Security Bar

In addition to the password protection function and the Kensington lock, the Security Bar helps protect the projector from unauthorized removal.

See the following picture.

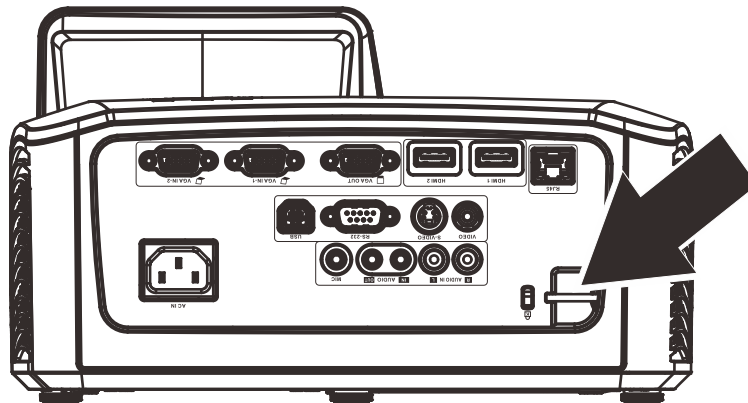

## Tips for Troubleshooting

In each problem-specific section, try the steps in the order suggested. This may help you to solve the problem more quickly.

Try to pin point the problem and thus avoid replacing non-defective parts.

For example, if you replace batteries and the problem remains, put the original batteries back and go to the next step.

Keep a record of the steps you take when troubleshooting: The information may be useful when calling for technical support or for passing on to service personnel.

## LED Messages

| ERROR CODE MESSAGES        | POWER LED GREEN | LAMP LED AMBER | TEMP LED RED |
|----------------------------|-----------------|----------------|--------------|
| Power On                   | ON              | OFF            | OFF          |
| Power Off                  | ON              | OFF            | OFF          |
| Cooling                    | Flashing        | OFF            | OFF          |
| Over Temperature           | OFF             | OFF            | ON           |
| Thermal Break Sensor error | 4 blinks        | OFF            | OFF          |
| Lamp error                 | OFF             | ON             | OFF          |
| Fan 1                      | 6 blinks        | 1 blinks       | OFF          |
| Fan 2                      | 6 blinks        | 2 blinks       | OFF          |
| Fan 3                      | 6 blinks        | 3 blinks       | OFF          |
| Fan 4                      | 6 blinks        | 4 blinks       | OFF          |
| Lamp Door Open             | 7 blinks        | OFF            | OFF          |
| DMD error                  | 8 blinks        | OFF            | OFF          |
| Color wheel error          | 9 blinks        | OFF            | OFF          |

In the event of an error, please disconnect the AC power cord and wait for one (1) minute before restarting the projector. If the Power or Lamp LEDs are still blinking or any other situation that isn't listed in the chart above, please contact your service center.

## Image Problems

### ***Problem: No image appears on the screen***

1. Verify the settings on your notebook or desktop PC.
2. Turn off all equipment and power up again in the correct order.

### ***Problem: The image is blurred***

1. Adjust the **Focus** on the projector.
2. Press the **Auto** button on the remote control.
3. Ensure the projector-to-screen distance is within the specified range.
4. Check that the projector lens is clean.

### ***Problem: The image is wider at the top or bottom (keystone distortion)***

1. Position the projector so it is as perpendicular to the screen as possible.
2. Use the **Keystone** button on the remote control to correct the problem.

### ***Problem: The image is reversed***

Check the **Image Flip H/V** setting on the **Installation I** menu of the OSD.

### ***Problem: The image is streaked***

1. Set the **Frequency** and **Total Dots** settings on the **Computer** menu of the OSD to the default settings.
2. To ensure the problem is not caused by a connected PC's video card, connect to another computer.

### ***Problem: The image is flat with no contrast***

Adjust the **Contrast** setting on the **Image** menu of the OSD.

### ***Problem: The color of the projected image does not match the source image.***

1. Adjust the **Gamma** settings on the **Image** menu of the OSD.



2. Adjust the **Color Temperature** settings on the **Image->Advanced** menu of the OSD.

## Lamp Problems

### ***Problem: There is no light from the projector***

1. Check that the power cable is securely connected.
2. Ensure the power source is good by testing with another electrical device.
3. Restart the projector in the correct order and check that the Power LED is on.
4. If you have replaced the lamp recently, try resetting the lamp connections.
5. Replace the lamp.
6. Put the old lamp back in the projector and have the projector serviced.

### ***Problem: The lamp goes off***

1. Power surges can cause the lamp to turn off. Re-plug power cord. When the Power LED is on, press the power button.
2. Replace the lamp.
3. Put the old lamp back in the projector and have the projector serviced.

## Remote Control Problems

### ***Problem: The projector does not respond to the remote control***

1. Direct the remote control towards remote sensor on the projector.
2. Ensure the path between remote and sensor is not obstructed.
3. Turn off any fluorescent lights in the room.
4. Check the battery polarity.
5. Replace the battery.
6. Turn off other Infrared-enabled devices in the vicinity.
7. Have the remote control serviced.

## Audio Problems

### ***Problem: There is no sound***

1. Adjust the volume on the remote control.
2. Adjust the volume of the audio source.
3. Check the audio cable connection.
4. Test the source audio output with other speakers.
5. Have the projector serviced.

### ***Problem: The sound is distorted***

1. Check the audio cable connection.
2. Test the source audio output with other speakers.
3. Have the projector serviced.

## Having the Projector Serviced

If you are unable to solve the problem, you should have the projector serviced. Pack the projector in the original carton. Include a description of the problem and a checklist of the steps you took when trying to fix the problem: The information may be useful to service personnel. For servicing, return the projector to the place you purchased it.

## Product Specifications

|   |   |  |
|---|---|--|
| <b>Model name</b>   |   | LV-WX300UST / LV-WX300USTi                                       |
| <b>Display system</b>   |   | 1 chip DLP system  |
| <b>Optical system</b>   |   | Time division color extraction, sequential display               |
| Display device  |   |  |
| <b>Display device</b>   | <b>Type</b>                                 | DMD x1   |
|   | <b>Size / Aspect ratio</b>                  | 0.65 type / 16:10  |
|   | <b>Number dots<br/>(=Total number dots)</b> | 1,024,000  |
| Projection lens   |   |  |
| <b>Projection lens</b>  | <b>Operation</b>                            | Zoom: fixed, focus: manual                                       |
|   | <b>Focal length / F number</b>              | 5.1 mm / 2.5   |
|   | <b>Throw ratio</b>                          | 0.35:1   |
|   | <b>Projection distance</b>                  | 60.5 - 70.5 cm   |
|   | <b>Lens shift</b>                           | 75%, fixed   |
| <b>Light source</b>   |   | 230W Super-high pressure mercury lamp                            |
| <b>Image size</b>   |   | 80 - 100 type  |
| <b>Number of colors</b>   |   | 16,770,000 (full color)  |
| <b>Brightness *1</b>  |   | 3000 lumen (in presentation mode)                                |
| <b>Contrast ratio *1</b>  |   | 2300:1 (Fully white: fully black, presentation mode)             |
| <b>Ratio of brightness at periphery to center *1</b>  |   | 80%  |
| <b>Speaker</b>  |   | 10W x2 (stereo)  |
| <b>Maximum input resolution</b>   |   | 1600x1200  |
| Image signal  |   |  |
| <b>Image signal</b>   | <b>PC (analog)</b>                          | WXGA, UXGA, SXGA+, WXGA, SXGA, XGA, SVGA, VGA, Mac               |
|   | <b>PC (digital)</b>                         | UXGA, SXGA+, WXGA+, WXGA, SXGA, XGA, SVGA, VGA                   |
|   | <b>Digital video</b>                        | 1080p, 1080i, 720p, 576p, 480p                                   |
|   | <b>Component video</b>                      | 1080p, 1080i, 720p, 576p, 576i, 480p, 480i                       |
|   | <b>Video / S video</b>                      | NTSC, PAL, SECAM, NTSC4.43, PAL-M, PAL-N, PAL-60                 |
| <b>Audio signal</b>   |   | Impedance = 47KΩ or more   |
| Terminal (Input/output/control)   |   |  |
| <b>Input</b>  | <b>VGA in -1, 2</b>                         | Analog PC, component video (mini D-sub15 pin)                    |
|   | <b>HDMI -1, 2</b>                           | Digital PC, digital video  |
|   | <b>S-VIDEO</b>                              | S video  |
|   | <b>VIDEO</b>                                | Video  |
|   | <b>AUDIO IN(R,L)</b>                        | Audio input (2RCA)   |
|   | <b>AUDIO IN</b>                             | Audio input (3.5φ stereo mini jack)                              |
| <b>Output</b>   | <b>VGA OUT</b>                              | Monitor out (mini D-sub15 pin)                                   |
|   | <b>AUDIO OUT</b>                            | Audio output (3.5φ stereo mini jack)                             |
| <b>Control</b>  | <b>USB</b>                                  | USB Type B, mini USB (interactive used)                          |
|   | <b>RS-232</b>                               | Serial connection  |
|   | <b>RJ45</b>                                 | Network connection   |
| <b>Noise level</b>  |   | 33/29 dB   |
| <b>Operating temperature</b>  |   | 5°C - 40°C   |
| <b>Power supply</b>   |   | AC100V - 240V, 50 / 60Hz   |
| <b>Power consumption</b>  |   | 300W, 240W (Lamp mode: Full power, Power savor)                  |
| <b>Standby power consumption</b>  |   | 6.0W, 0.5W (Network / RS232)                                     |
| <b>Dimensions</b>   | <b>LV-WX300UST</b>                          | W: 287.5 mm ×H: 167.6 mm ×D: 374.5 mm (including the projection) |
|   | <b>LV-WX300USTi</b>                         | W: 287.5 mm ×H: 193.7 mm ×D: 374.5 mm (including the projection) |
| <b>Mass</b>   |   | 5.0 kg   |
| Accessories   |   |  |
| Remote control, battery for remote control, power code, VGA cable, User's manual (CD-ROM), Important Information, Warranty Card |   |  |
| Interactive software(CD-ROM) ,2Interactive Pens, battery for Interactive Pens, mini USB Cable                                   |   |  |

\*1 Compliance with ISO21118-2012

# Installation Distance vs. Projection Size

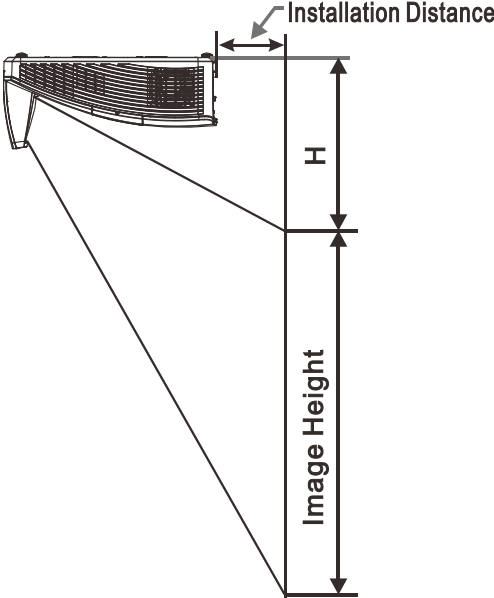

*Installation Distance and Size Table*

|              | WXGA         |              |              |              |
|--------------|--------------|--------------|--------------|--------------|
|              | 16:10        |              |              |              |
| Diagonal     | 80"          | 87"          | 97"          | 100"         |
| Distance     | 282.3+/-20mm | 340.3+/-20mm | 421.4+/-20mm | 445.8+/-20mm |
| Image Width  | 1723mm       | 1874mm       | 2088mm       | 2154mm       |
| Image height | 1077mm       | 1171mm       | 1305mm       | 1346mm       |
| H            | 280+/-50mm   | 300.2+/-50mm | 325.5+/-50mm | 336.9+/-50mm |

## Timing Mode Table

The projector can display several resolutions. The following table outlines the resolutions that can be displayed by the projector.

| SIGNAL          | RESOLUTION       | HORIZONTAL FREQUENCY (KHz) | VERTICAL FREQUENCY (Hz) | COMPOSITE | COMPONENT | ANALOG PC | HDMI |
|-----------------|------------------|----------------------------|-------------------------|-----------|-----------|-----------|------|
| NTSC            | —                | 15.734                     | 60.0                    | O         | —         | —         | —    |
| PAL/SECAM       | —                | 15.625                     | 50.0                    | O         | —         | —         | —    |
| VESA            | 720 x 400        | 37.9                       | 85.04                   | —         | —         | O         | O    |
|                 | 640 x 480        | 31.5                       | 60.0                    | —         | —         | O         | O    |
|                 | 640 x 480        | 37.9                       | 72.8                    | —         | —         | O         | O    |
|                 | 640 x 480        | 37.5                       | 75.0                    | —         | —         | O         | O    |
|                 | 640 x 480        | 43.3                       | 85.0                    | —         | —         | O         | O    |
|                 | 800 x 600        | 35.2                       | 56.3                    | —         | —         | O         | O    |
|                 | * 800 x 600      | 37.9                       | 60.3                    | —         | —         | O         | O    |
|                 | 800 x 600        | 46.9                       | 75.0                    | —         | —         | O         | O    |
|                 | 800 x 600        | 48.1                       | 72.2                    | —         | —         | O         | O    |
|                 | 800 x 600        | 53.7                       | 85.1                    | —         | —         | O         | O    |
|                 | ** 800 x 600     | 76.3                       | 120.0                   | —         | —         | O         | O    |
|                 | 1024 x 576       | 35.8                       | 60.0                    | —         | —         | O         | O    |
|                 | 1024 x 600       | 37.3                       | 60.0                    | —         | —         | O         | O    |
|                 | 1024 x 600       | 41.5                       | 65.0                    | —         | —         | O         | O    |
|                 | * 1024 x 768     | 48.4                       | 60.0                    | —         | —         | O         | O    |
|                 | 1024 x 768       | 56.5                       | 70.1                    | —         | —         | O         | O    |
|                 | 1024 x 768       | 60.0                       | 75.0                    | —         | —         | O         | O    |
|                 | 1024 x 768       | 68.7                       | 85.0                    | —         | —         | O         | O    |
|                 | ** 1024 x 768    | 97.6                       | 120.0                   | —         | —         | O         | O    |
|                 | 1024 x 768       | 99.0                       | 120.0                   | —         | —         | O         | O    |
|                 | 1152 x 864       | 67.5                       | 75.0                    | —         | —         | O         | O    |
|                 | * 1280 x 720     | 45.0                       | 60.0                    | —         | —         | O         | O    |
|                 | * 1280 x 720     | 90.0                       | 120.0                   | —         | —         | O         | O    |
|                 | 1280 x 768       | 47.4                       | 60.0                    | —         | —         | O         | O    |
|                 | * 1280 x 768     | 47.8                       | 59.9                    | —         | —         | O         | O    |
|                 | * 1280 x 800     | 49.7                       | 59.8                    | —         | —         | O         | O    |
|                 | 1280 x 800       | 62.8                       | 74.9                    | —         | —         | O         | O    |
|                 | 1280 x 800       | 71.6                       | 84.9                    | —         | —         | O         | O    |
|                 | ** 1280 x 800    | 101.6                      | 119.9                   | —         | —         | O         | O    |
|                 | *** 1280 x 1024  | 64.0                       | 60.0                    | —         | —         | O         | O    |
|                 | 1280 x 1024      | 80.0                       | 75.0                    | —         | —         | O         | O    |
|                 | 1280 x 1024      | 91.1                       | 85.0                    | —         | —         | O         | O    |
|                 | *** 1280 x 960   | 60.0                       | 60.0                    | —         | —         | O         | O    |
|                 | 1280 x 960       | 85.9                       | 85.0                    | —         | —         | O         | O    |
|                 | **** 1280 x 1470 | —                          | 60.0                    | —         | —         | —         | O    |
|                 | *** 1366 x 768   | 47.7                       | 59.8                    | —         | —         | O         | O    |
| *** 1400 x 1050 | 65.3             | 60.0                       | —                       | —         | O         | O         |      |
| 1440 x 900      | 55.5             | 59.9                       | —                       | —         | O         | O         |      |
| *** 1440 x 900  | 55.9             | 59.9                       | —                       | —         | O         | O         |      |

| SIGNAL          | RESOLUTION       | HORIZONTAL FREQUENCY (KHz) | VERTICAL FREQUENCY (Hz) | COMPOSITE | COMPONENT | ANALOG PC | HDMI |
|-----------------|------------------|----------------------------|-------------------------|-----------|-----------|-----------|------|
|                 | 1440 x 900       | 70.6                       | 75.0                    | —         | —         | O         | O    |
|                 | 1600 x 1200      | 75.0                       | 60                      | —         | —         | O         | O    |
|                 | 1680 x 1050      | 64.7                       | 59.9                    | —         | —         | O         | O    |
|                 | 1680 x 1050      | 65.3                       | 60.0                    | —         | —         | O         | O    |
|                 | 1920 x 1200      | 74.0                       | 60.0                    | —         | —         | O         | O    |
|                 | 1920 x 1080      | 67.5                       | 60.0                    | —         | —         | O         | O    |
|                 | **** 1920 x 2205 | —                          | 23.97                   | —         | —         | —         | O    |
| Apple Macintosh | 640 x 480        | 35.0                       | 66.7                    | —         | —         | O         | O    |
|                 | 832 x 624        | 49.7                       | 74.5                    | —         | —         | O         | O    |
|                 | 1024 x 768       | 60.2                       | 74.9                    | —         | —         | O         | O    |
|                 | 1152 x 870       | 68.7                       | 75.1                    | —         | —         | O         | O    |
| SDTV            | 480i             | 15.734                     | 60.0                    | —         | O         | —         | O    |
|                 | 576i             | 15.625                     | 50.0                    | —         | O         | —         | O    |
| EDTV            | 576p             | 31.3                       | 50.0                    | —         | O         | —         | O    |
|                 | 480p             | 31.5                       | 60.0                    | —         | O         | —         | O    |
| HDTV            | 720p             | 37.5                       | 50.0                    | —         | O         | —         | O    |
|                 | 720p             | 45.0                       | 60.0                    | —         | O         | —         | O    |
|                 | 1080i            | 33.8                       | 60.0                    | —         | O         | —         | O    |
|                 | 1080i            | 28.1                       | 50.0                    | —         | O         | —         | O    |
|                 | 1080p            | 27                         | 24                      | —         | O         | —         | O    |
|                 | 1080p            | 28                         | 25                      | —         | O         | —         | O    |
|                 | 1080p            | 33.7                       | 30                      | —         | O         | —         | O    |
|                 | 1080p            | 67.5                       | 60.0                    | —         | O         | —         | O    |
|                 | 1080p            | 56.3                       | 50.0                    | —         | O         | —         | O    |

O: Frequency supported

—: Frequency not supported

★3D note :

“★” It means the timing can support non-3D and 3D signal with Frame Sequential and Top-Bottom format.

“★★” It means the timing can support non-3D and 3D signal with Frame Sequential format.

“★★★” It means the timing can support non-3D and 3D signal with Top-Bottom format.

“★★★★” It means the timing can support 3D signal with Frame Packing format.

There 3D timing showing depend the EDID file and display card. It is possible that user cannot choose the above 3D timings on display card.

The resolution of the panel is 1280 x 800. Resolution other than native resolution may display with uneven size of text or lines.

**Projector Dimensions(LV-WX300UST)**

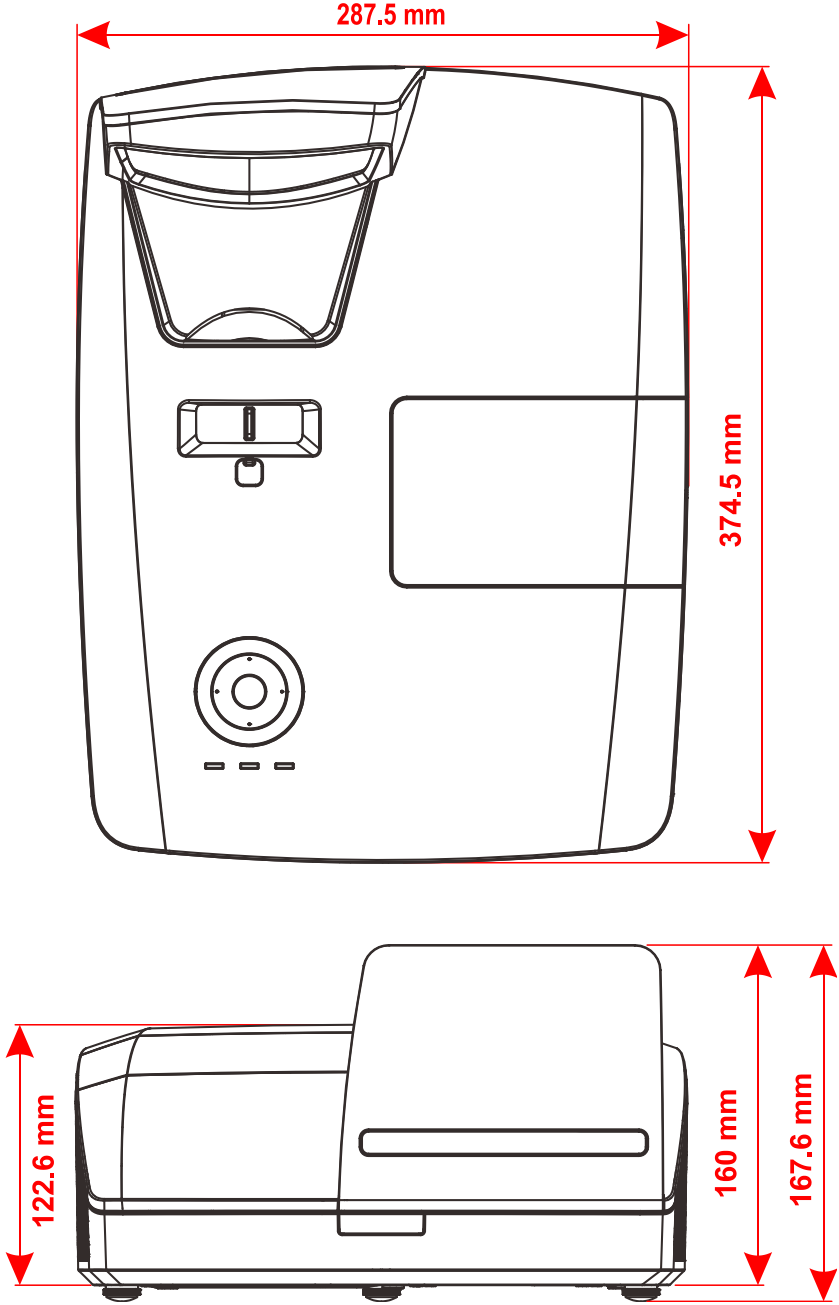

# Projector Dimensions(LV-WX300USTi)

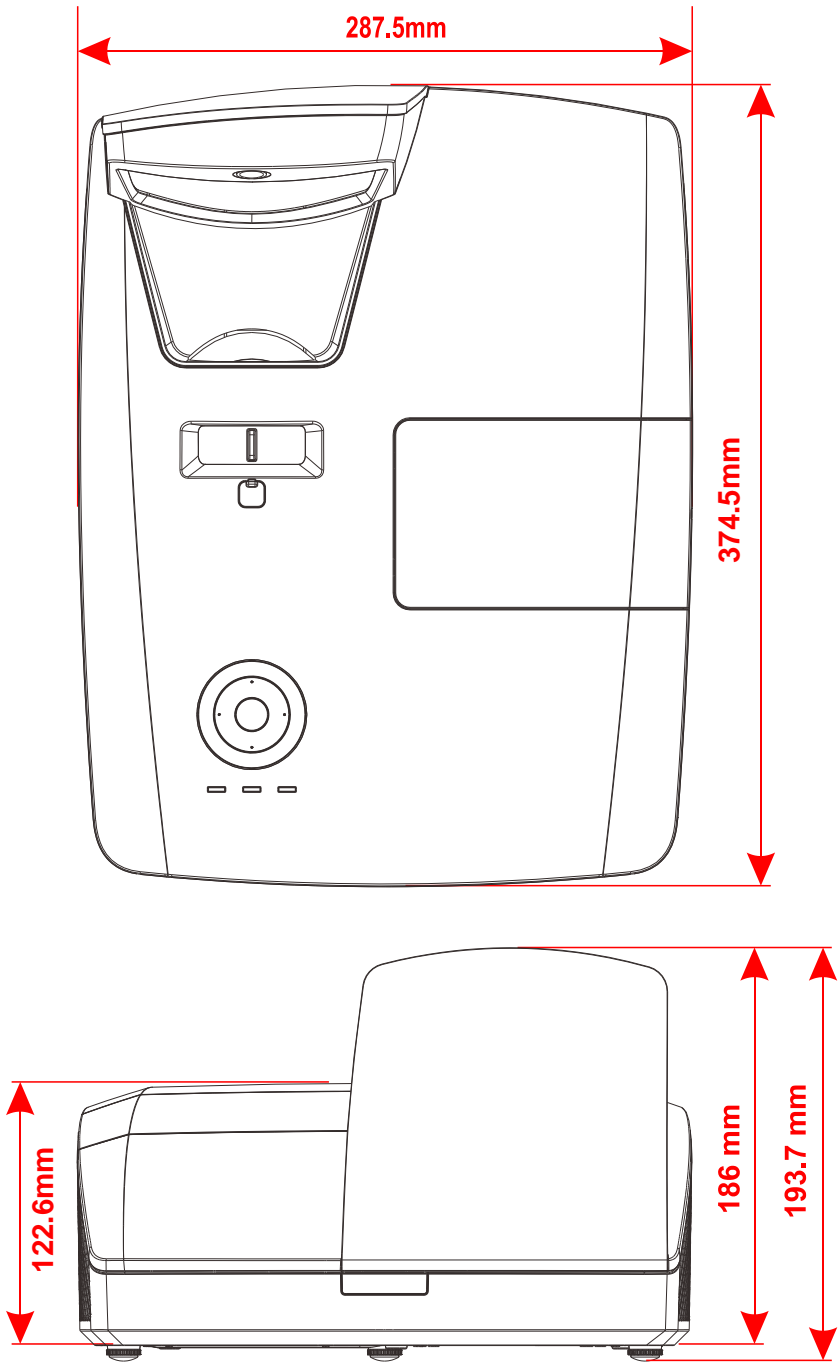

## Communication

|               |             |
|---------------|-------------|
| Baud rate:    | <b>9600</b> |
| Data bit:     | <b>8</b>    |
| Parity check: | <b>None</b> |
| Stop bit:     | <b>1</b>    |
| Flow Control  | <b>None</b> |

### Control Command Structure

The command is structured by the Header code, command code, data code and end code. Most of the commands are structured except some for the compatibility issue with other projectors.

|              | Header code | Command code   | Data code   | End code   |
|--------------|-------------|----------------|-------------|------------|
| <b>HEX</b>   | <b>7Eh</b>  | <b>Command</b> | <b>Data</b> | <b>0Dh</b> |
| <b>ASCII</b> | '~'         | <b>Command</b> | <b>Data</b> | <b>CR</b>  |

Command transfer using RS232(remote) and/or Network(LAN) does not available at power saver mode.

### Control Sequence

The projector may send a return code after it received a command. If the command isn't received correctly, the projector will not send the return code

### Operation Command

The operation commands execute the basic operation setting of this projector.

| Operation                     | ASCII      | HEX             |
|-------------------------------|------------|-----------------|
| <b>Power On</b> ※             | ~ P N CR ※ | 7Eh 50h 4Eh 0Dh |
| <b>Power Off</b>              | ~ P F CR   | 7Eh 50h 46h 0Dh |
| <b>Auto Image</b>             | ~ A I CR   | 7Eh 41h 49h 0Dh |
| <b>Lamp Hour Reset</b>        | ~ R L CR   | 7Eh 52h 4Ch 0Dh |
| <b>Input Select RGB</b>       | ~ S R CR   | 7Eh 53h 52h 0Dh |
| <b>Input Select RGB2</b>      | ~ S G CR   | 7Eh 53h 47h 0Dh |
| <b>Input Select DVI</b>       | ~ S I CR   | 7Eh 53h 44h 0Dh |
| <b>Input Select Video</b>     | ~ S V CR   | 7Eh 53h 56h 0Dh |
| <b>Input Select S-Video</b>   | ~ S S CR   | 7Eh 53h 53h 0Dh |
| <b>Input Select Component</b> | ~ S Y CR   | 7Eh 53h 59h 0Dh |
| <b>Input Select HDMI</b>      | ~ S H CR   | 7Eh 53h 48h 0Dh |
| <b>Input Select HDMI2</b>     | ~ S I CR   | 7Eh 53h 49h 0Dh |

※ Power On command will only word at system standby.

※ **CR**: Carriage Return.



## Remote Command

The remote commands simulate the code send from IR remote handset.

| Button's name | ASCII    | HEX             |
|---------------|----------|-----------------|
| UP arrow      | ~ r U CR | 7Eh 72h 55h 0Dh |
| DOWN arrow    | ~ r D CR | 7Eh 72h 44h 0Dh |
| LEFT arrow    | ~ r L CR | 7Eh 72h 4Ch 0Dh |
| RIGHT arrow   | ~ r R CR | 7Eh 72h 52h 0Dh |
| POWER         | ~ r P CR | 7Eh 72h 50h 0Dh |
| EXIT          | ~ r   CR | 7Eh 72h 45h 0Dh |
| INPUT         | ~ r I CR | 7Eh 72h 49h 0Dh |
| AUTO          | ~ r A CR | 7Eh 72h 41h 0Dh |
| KEYSTONE+     | ~ r K CR | 7Eh 72h 4Bh 0Dh |
| KEYSTONE-     | ~ r J CR | 7Eh 72h 4Ah 0Dh |
| MENU          | ~ r M CR | 7Eh 72h 4Dh 0Dh |
| STATUS        | ~ r S CR | 7Eh 72h 53h 0Dh |
| MUTE          | ~ r T CR | 7Eh 72h 54h 0Dh |
| ZOOM+         | ~ r Z CR | 7Eh 72h 5Ah 0Dh |
| ZOOM-         | ~ r Y CR | 7Eh 72h 59h 0Dh |
| BLANK         | ~ r B CR | 7Eh 72h 42h 0Dh |
| FREEZE        | ~ r F CR | 7Eh 72h 46h 0Dh |
| VOLUME+       | ~ r V CR | 7Eh 72h 56h 0Dh |
| VOLUME-       | ~ r W CR | 7Eh 72h 57h 0Dh |
| Enter         | ~ r N CR | 7Eh 72h 4Eh 0Dh |

## Set Value Command

| ITEM              | ASCII        | HEX                |
|-------------------|--------------|--------------------|
| Brightness        | ~ s B ? CR ※ | 7Eh 73h 42h ?h 0Dh |
| Contrast          | ~ s C ? CR   | 7Eh 73h 43h ?h 0Dh |
| Color             | ~ s R ? CR   | 7Eh 73h 52h ?h 0Dh |
| Tint              | ~ s N ? CR   | 7Eh 73h 4Eh ?h 0Dh |
| Scaling           | ~ s A ? CR   | 7Eh 73h 41h ?h 0Dh |
| Color Temperature | ~ s T ? CR   | 7Eh 73h 54h ?h 0Dh |
| Projection Mode   | ~ s J ? CR   | 7Eh 73h 4Ah ?h 0Dh |
| Sharpness         | ~ s H ? CR   | 7Eh 73h 48h ?h 0Dh |

※ \*?: ASCII Data

## Data Range

| ITEM              | Set Data Range   | Source                  |
|-------------------|--|-------------------------|
| Brightness        | 0 ~ 100  | ALL                     |
| Contrast          | 0 ~ 100  | ALL                     |
| Color             | 0 ~ 100  | Video/S-Video/Component |
| Tint              | 0 ~ 100  | Video/S-Video/Component |
| Scaling           | 0: Fill 1: 4:3 2: 16:9 3: Letter Box<br>4: Native                | ALL                     |
| Color Temperature | 0: Native 1: 6500K 2: 7500K 3: 8200K                             | ALL                     |
| Projection Mode   | 0: Rear Table 1: Front Table<br>2: Rear Ceiling 3: Front Ceiling | ALL                     |
| Sharpness         | 0~31   | ALL                     |

Attention: Data range may be different for different models

Example 1. Adjust Brightness value to 100

Send Command : ~sB100CR

Example 2. Adjust Color Temperature to Warm

Send Command : ~sT2CR

## Query Command

| ITEM              | ASCII | HEX             |
|-------------------|-------|-----------------|
| Software Version  | ~qVCR | 7Eh 71h 56h 0Dh |
| Power State       | ~qPCR | 7Eh 71h 50h 0Dh |
| Input Select      | ~qSCR | 7Eh 71h 53h 0Dh |
| Lamp Hours        | ~qLCR | 7Eh 71h 4Ch 0Dh |
| Brightness        | ~qBCR | 7Eh 71h 42h 0Dh |
| Contrast          | ~qCCR | 7Eh 71h 43h 0Dh |
| Color (Video)     | ~qRCR | 7Eh 71h 52h 0Dh |
| Tint (Video)      | ~qNCR | 7Eh 71h 4Eh 0Dh |
| Scaling           | ~qACR | 7Eh 71h 41h 0Dh |
| Color Temperature | ~qTCR | 7Eh 71h 54h 0Dh |
| Projection Mode   | ~qJCR | 7Eh 71h 4Ah 0Dh |
| Sharpness         | ~qHCR | 7Eh 71h 48h 0Dh |
| Volume            | ~qMCR | 7Eh 71h 4Dh 0Dh |
| Freeze Status     | ~qZCR | 7Eh 71h 5Ah 0Dh |
| Mute Status       | ~qUCR | 7Eh 71h 55h 0Dh |
| Blank Status      | ~qKCR | 7Eh 71h 4Bh 0Dh |

## Response message

| ITEM              | Response Message examples  |
|-------------------|--|
| Software Version  | .....  |
| Power State       | On Off   |
| Input Select      | RGB1 RGB2 <input type="checkbox"/> Video S-Video<br>Component HDMI |
| Lamp Hours        | 2000   |
| Brightness        | 100  |
| Contrast          | 100  |
| Color (Video)     | 100  |
| Tint (Video)      | 100  |
| Scaling           | Fill 4:3 16:9 LetterBox Native                                     |
| Color Temperature | Native 6500K 7500K 8200K   |
| Projection Mode   | Rear Table Front Table<br>Rear Ceiling Front Ceiling               |
| Sharpness         | 31   |
| Volume            | 8  |
| Freeze Status     | On Off   |
| Mute Status       | On Off   |
| Blank Status      | On Off   |

Example 1. Get Brightness value

Send Command : ~qB<sup>CR</sup>

Response : 100

Example 2. Get Color Temperature

Send Command : ~qT<sup>CR</sup>

Response : 6500K

**CANON INC.**

30-2, Shimomaruko 3-chome, Ohta-ku, Tokyo  
146-8501, Japan

U.S.A.

**CANON U.S.A. INC.**

One Canon Park, Melville, New York 11747,  
U.S.A.

For all inquires concerning this product, call toll  
free in the U.S. 1-800-OK-CANON

CANADA

**CANON CANADA INC. HEADQUARTERS**

6390 Dixie Road, Mississauga, Ontario L5T  
1P7, Canada

**CANON CANADA INC. MONTREAL  
BRANCH**

5990, Côte-de-Liesse, Montréal Québec H4T  
1V7, Canada

**CANON CANADA INC. CALGARY OFFICE**

2828, 16th Street, N.E. Calgary, Alberta T2E  
7K7, Canada

For all inquiries concerning this product, call  
toll free in Canada 1-800-OK-CANON

EUROPE, AFRICA & MIDDLE EAST

**CANON EUROPE LTD.**

3 The Square, Stockley Park, Uxbridge,  
Middlesex, UB11 1ET United Kingdom

**CANON EUROPA N.V.**

Bovenkerkerweg 59, 1185 XB Amstelveen,  
The Netherlands

**CANON FRANCE S.A.S**

17, quai du President Paul Doumer, 92414  
Courbevoie Cedex, France

**CANON UK LTD.**

Woodhatch Reigate Surrey RH2 8BF, United  
Kingdom

**CANON DEUTSCHLAND GmbH**

Europark Fichtenhain A10, 47807 Krefeld,  
Germany

**CANON ITALIA S.p.A.**

Via Milano 8 I-20097 San Donato Milanese,  
Milano, Italy

**CANON Schweiz AG**

Geschäftsbereich Wiederverkauf,  
Industriestrasse 12, CH-8305 Dietlikon,  
Switzerland

**CANON GMBH**

Zetschegasse 11, A-1230 Wien, Austria

**CANON España, S.A.**

Av. De Europa, 6 Alcobendas 28108 Madrid,  
Spain

**CANON PORTUGAL S.A.**

Rua Alfredo da Silva, 14 Alfragide 2610-016  
Amadora, Portugal

**CANON Belgium N.V. / S.A.**

Berkenlaan 3, 1831 Diegem (Mechelen),  
Belgium

**CANON Netherland NV**

Neptunusstraat 1, 2132 JA Hoofddorp, The  
Netherlands

**CANON LUXEMBOURG S.A.**

Rue des Joncs 21, L-1818 Howald,  
Luxembourg

**CANON DANMARK A / S**

Knud Hoejgaards Vej 1 DK-2860 Soeborg,  
Danmark

**CANON OY**

Huopalahdentie 24 PL 1 00351 Helsinki,  
Finland

**CANON SVENSKA AB**

Gustav III:s Boulevard 26 169 88 Solna,  
Sweden

**CANON NORGE as**

Hallagerbakken 110, Postboks 33, Holmlia,  
1201 Oslo, Norway

CENTRAL & SOUTH AMERICA

**CANON LATIN AMERICA, INC.**

703 Waterford Way, Ste. 400 Miami, FL 33126,  
U.S.A.

ASIA

**CANON (China) Co., Ltd.**

15F Jinbao Building No.89 Jinbao Street,  
Dongcheng District, Beijing 100005, China

**CANON HONGKONG CO., LTD.**

19 / F., The Metropolis Tower, 10 Metropolis  
Drive, Hunghom, Kowloon, Hong Kong

**CANON SINGAPORE PTE. LTD.**

1 HarbourFront Avenue, #04-01 Keppel Bay  
Tower, Singapore 098632

**CANON KOREA CONSUMER IMAGING INC.**

Canon BS Tower 5F, #168-12 Samseongdong,  
Gangnam-gu, Seoul, Korea

OCEANIA

**CANON AUSTRALIA PTY. LTD.**

1 Thomas Holt Drive, North Ryde, N.S.W.  
2113, Australia

**CANON NEW ZEALAND LTD.**

Akoranga Business Park, Akoranga Drive,  
Northcote, Auckland, New Zealand