

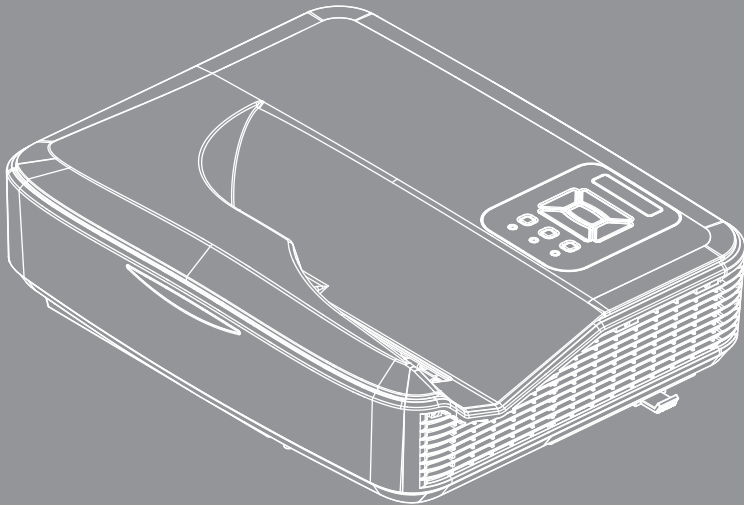

# DLP® Projector



User manual





# Table of Contents

<b>Table of Contents</b> .....	2	<b>Multimedia</b> .....	40
<b>Usage Notice</b> .....	3	<i>Accessing Multimedia Files</i> .....	40
<i>Safety Information</i> .....	3	<i>How to access Multimedia mode</i> .....	40
<i>Precautions</i> .....	4	<b>Appendices</b> .....	47
<b>Introduction</b> .....	6	<i>Installing and Cleaning the Optional</i>	
<i>Package Overview</i> .....	6	<i>Dust Filter</i> .....	47
<i>Product Overview</i> .....	7	<i>MMA Support List</i> .....	48
<i>Main Unit</i> .....	7	<i>Compatibility Modes</i> .....	53
<i>Control Panel</i> .....	8	<i>VGA Analog</i> .....	53
<i>Input/Output Connections</i> .....	9	<i>HDMI Digital</i> .....	55
<i>Remote Control</i> .....	10	<i>RS232 Protocol Function List</i> .....	57
<b>Installation</b> .....	11	<i>Regulation &amp; Safety Notices</i> .....	59
<i>Connecting the Projector</i> .....	11	<i>Ceiling Mount Installation</i> .....	62
<i>Connect to Computer/Notebook</i> .....	11		
<i>Connect to Video Sources</i> .....	12		
<i>Powering the Projector On / Off</i> .....	13		
<i>Powering On the Projector</i> .....	13		
<i>Powering Off the Projector</i> .....	14		
<i>Warning Indicator</i> .....	14		
<i>Adjusting the Projected Image</i> .....	15		
<i>Adjusting the Projector's Height</i> .....	15		
<i>Adjusting the Projector's Focus</i> .....	16		
<i>Adjusting Projection Image Size</i>			
<i>(Diagonal)</i> .....	17		
<b>User Controls</b> .....	19		
<i>Control Panel &amp; Remote Control</i> .....	19		
<i>Control Panel</i> .....	19		
<i>Remote Control</i> .....	20		
<i>On-screen Display Menus</i> .....	22		
<i>How to operate</i> .....	22		
<i>Picture</i> .....	23		
<i>Screen</i> .....	25		
<i>Setting</i> .....	27		
<i>Volume</i> .....	29		
<i>Options</i> .....	30		
<i>Options   Laser Settings</i> .....	32		
<i>3D</i> .....	33		
<i>Multimedia</i> .....	34		

# Usage Notice

## Safety Information

	The lightning flash with arrow head within an equilateral triangle is intended to alert the user to the presence of uninsulated "dangerous voltage" within the product's enclosure that may be of sufficient magnitude to constitute a risk of electric shock to persons.
	The exclamation point within an equilateral triangle is intended to alert the user to the presence of important operating and maintenance (servicing) instructions in the literature accompanying the appliance.

**WARNING:** TO REDUCE THE RISK OF FIRE OR ELECTRIC SHOCK, DO NOT EXPOSE THIS APPLIANCE TO RAIN OR MOISTURE. DANGEROUS HIGH VOLTAGES ARE PRESENT INSIDE THE ENCLOSURE. DO NOT OPEN THE CABINET. REFER SERVICING TO QUALIFIED PERSONNEL ONLY.

### Class B emissions limits

This Class B digital apparatus meets all requirements of the Canadian Interference-Causing Equipment Regulations.

### Important Safety Instruction

1. Do not block any ventilation openings. To ensure reliable operation of the projector and to protect from over heating, it is recommended to install the projector in a location that does not block ventilation. As an example, do not place the projector on a crowded coffee table, sofa, bed, etc. Do not put the projector in an enclosure such as a book case or a cabinet that restricts air flow.
2. Do not use the projector near water or moisture. To reduce the risk of fire and/or electric shock, do not expose the projector to rain or moisture.
3. Do not install near heat sources such as radiators, heaters, stoves or any other apparatus such as amplifiers that emits heat.
4. Clean only with dry cloth.
5. Only use attachments/accessories specified by the manufacturer.
6. Do not use the unit if it has been physically damaged or abused.  
Physical damage/abuse would be (but not limited to):
  - Unit has been dropped.
  - Power supply cord or plug has been damaged.
  - Liquid has been spilled on to the projector.
  - Projector has been exposed to rain or moisture.
  - Something has fallen in the projector or something is loose inside.Do not attempt to service the unit yourself. Opening or removing covers may expose you to dangerous voltages or other hazards.
7. Do not let objects or liquids enter the projector. They may touch dangerous voltage points and short out parts that could result in fire or electric shock.
8. See projector enclosure for safety related markings.
9. The unit should only be repaired by appropriate service personnel.

## Precautions



*Please follow all warnings, precautions and maintenance as recommended in this user's guide.*

- Warning- Do not look into the projector's lens when the lamp is on. The bright light may hurt and damage your eyes.
- Warning- To reduce the risk of fire or electric shock, do not expose this projector to rain or moisture.
- Warning- Please do not open or disassemble the projector as this may cause electric shock.

# Usage Notice

## **Do:**

- ❖ Turn off and unplug the power plug from the AC outlet before cleaning the product.
- ❖ Use a soft dry cloth with mild detergent to clean the display housing.
- ❖ Disconnect the power plug from AC outlet if the product is not being used for a long period of time.

## **Do not:**

- ❖ Block the slots and openings on the unit provided for ventilation.
- ❖ Use abrasive cleaners, waxes or solvents to clean the unit.
- ❖ Use under the following conditions:
  - In extremely hot, cold or humid environments.
    - ▶ Sea level to 6000 feet  
Extremely hot: > 35°C  
Extremely cool: < 5°C
    - ▶ 6000 feet above  
Extremely hot: > 30°C  
Extremely cool: < 5°C
    - ▶ Extremely humid: > 70% R.H. (Relative Humidity)
  - In areas susceptible to excessive dust and dirt.
  - Near any appliance generating a strong magnetic field.
  - In direct sunlight.

# Introduction

## Package Overview

*Unpack and inspect the box contents to ensure all parts listed below are in the box. If something is missing, please contact your nearest customer service center.*

### Standard Accessories

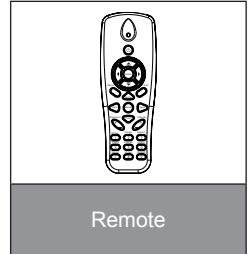
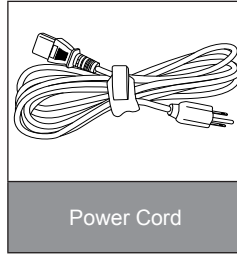
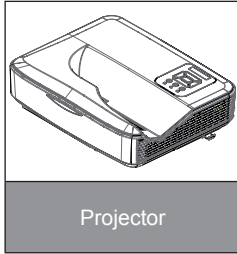

- ❖ Optional accessories vary depending on model, specification and region.
- ❖ For other laser curtain accessories, please refer to the laser curtain user manual.
- ❖ \*For European warranty information please visit [www.optomaeu-rope.com](http://www.optomaeu-rope.com)

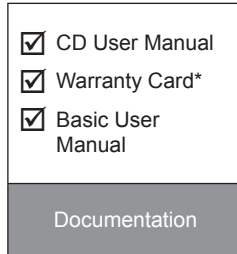
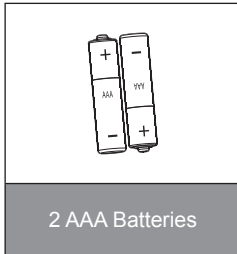

### Optional Accessories

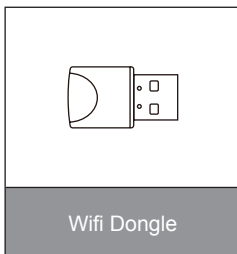
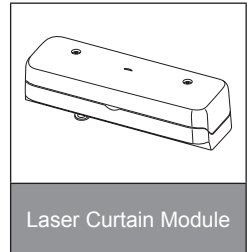
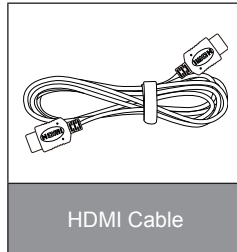
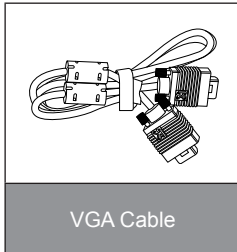

## Product Overview

### Main Unit

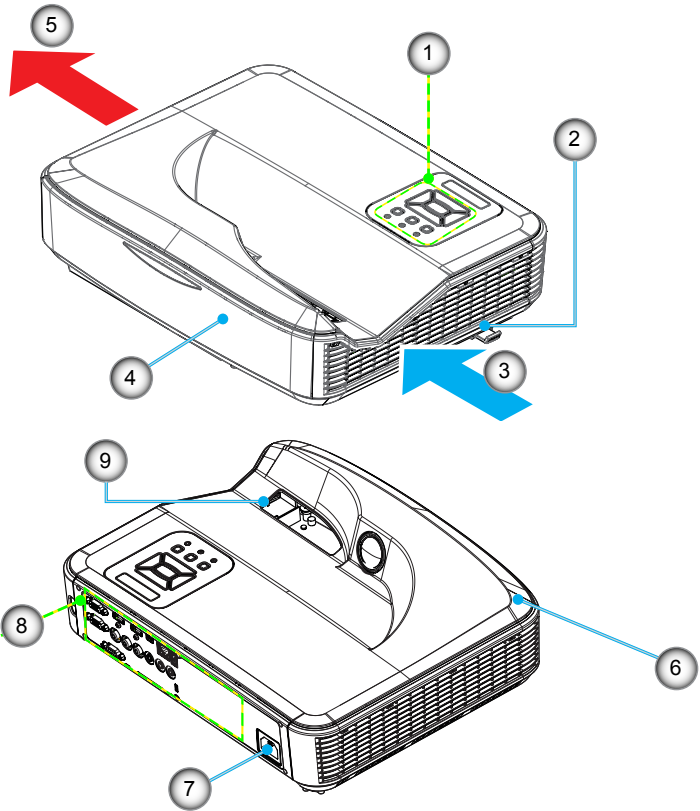

- ❖ The interface is subject to model's specifications.
- ❖ Do not block projector in/out air vents.

- |                         |                               |
|-------------------------|-------------------------------|
| 1. Control Panel        | 6. Speaker                    |
| 2. Focus Switch         | 7. Power Socket               |
| 3. Ventilation (inlet)  | 8. Input / Output Connections |
| 4. IR Receiver          | 9. Lens                       |
| 5. Ventilation (outlet) |                               |

# Introduction

## Control Panel

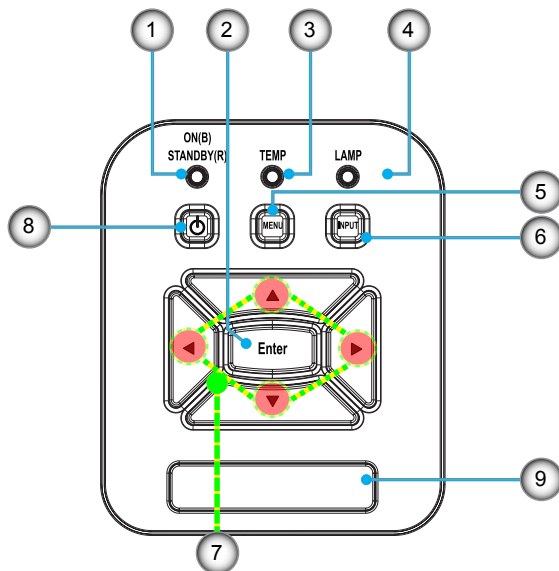

1. Power LED
2. Enter
3. Temp LED
4. Lamp LED
5. Menu
6. Input
7. Four Directional Select Keys
8. Power/Standby button
9. IR Receiver



## Input/Output Connections

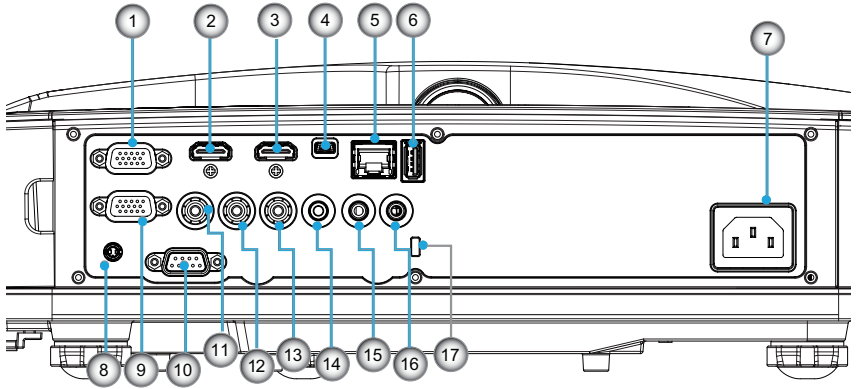

❖ The interface is subject to model's specifications.



❖ Monitor loop through only support in VGA1-In/YPbPr.

1. VGA1-In/YPbPr Connector  
(PC Analog Signal/Component Video Input/HDTV/YPbPr)
2. HDMI2 Input Connector
3. HDMI1 Input Connector
4. USB Connector (Connect to PC for Remote Mouse function)
5. RJ45 connector (Optional)
6. USB Type A Connector (Optional)
7. Power Socket
8. Interactive connector (3.5mm mini-jack, optional)
9. VGA-Out/VGA2-In Connector
10. RS-232 Connector (9-pin DIN Type)
11. Composite Video Input Connector
12. Composite Audio Input (right) Connector
13. Composite Audio Input (left) Connector
14. Audio Output Connector (3.5mm mini jack)
15. Audio Input Connector (3.5mm mini jack)
16. Audio Input Connector (microphone)
17. Kensington™ Lock Port

# Introduction

## Remote Control

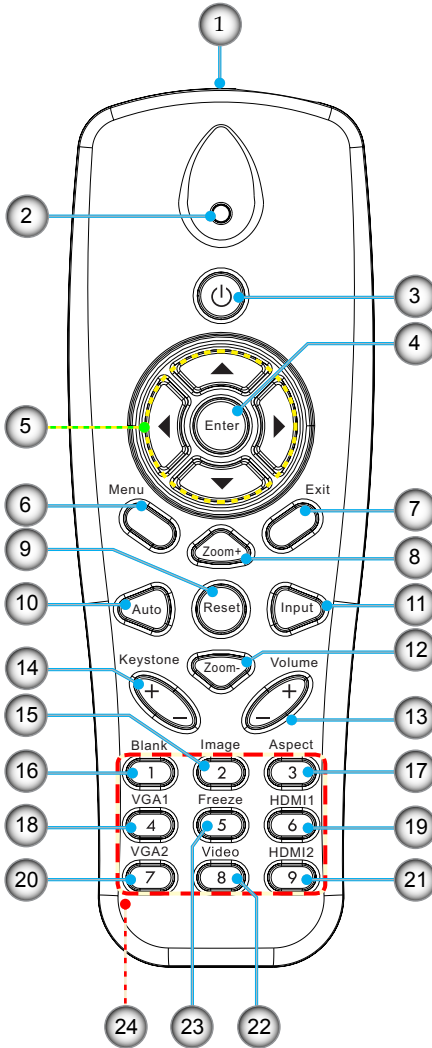

1. Infrared transmitter
2. LED Indicator
3. Power On/Off
4. OK
5. Four Directional Select Keys
6. Menu
7. Exit
8. Zoom in
9. Reset
10. Auto
11. Source
12. Zoom out
13. Volume +/-
14. Keystone +/-
15. Image
16. Black screen
17. Aspect ratio
18. VGA1
19. HDMI1
20. VGA2
21. HDMI2
22. Video
23. Screen freeze
24. Numbered keypad (for password input)



❖ Some keys may have on function for models which do not support these features.

# Installation

## Connecting the Projector Connect to Computer/Notebook

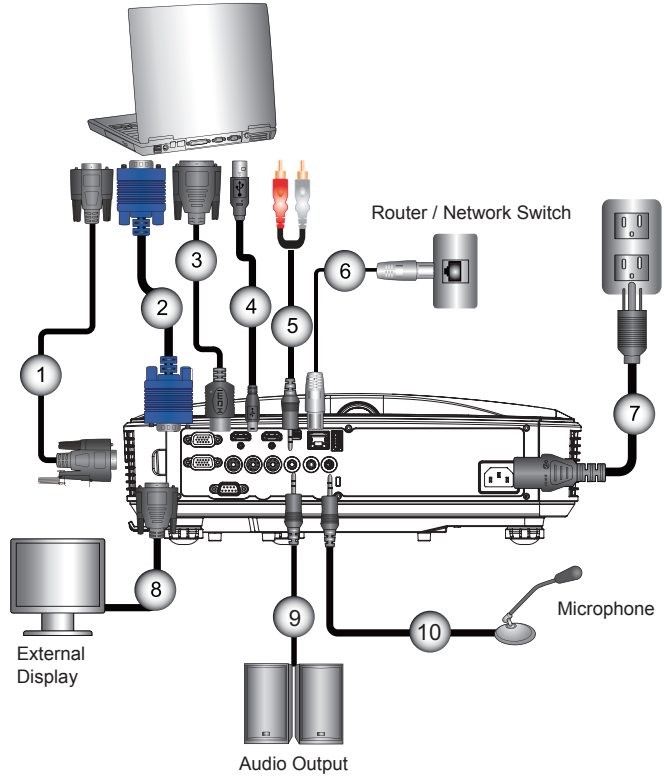

- ❖ Due to the difference in applications for each country, some regions may have different accessories.
- ❖ (\*) Optional accessory

1.....	*RS232 Cable
2.....	*VGA Cable
3.....	*HDMI Cable
4.....	*USB Cable
5.....	*Audio Cable/RCA
6.....	*RJ45 Cable
7.....	Power Cord
8.....	*VGA Output Cable
9.....	Interactive Cable
10.....	*Audio Output Cable
11.....	*Audio Input Cable

# Installation

## Connect to Video Sources

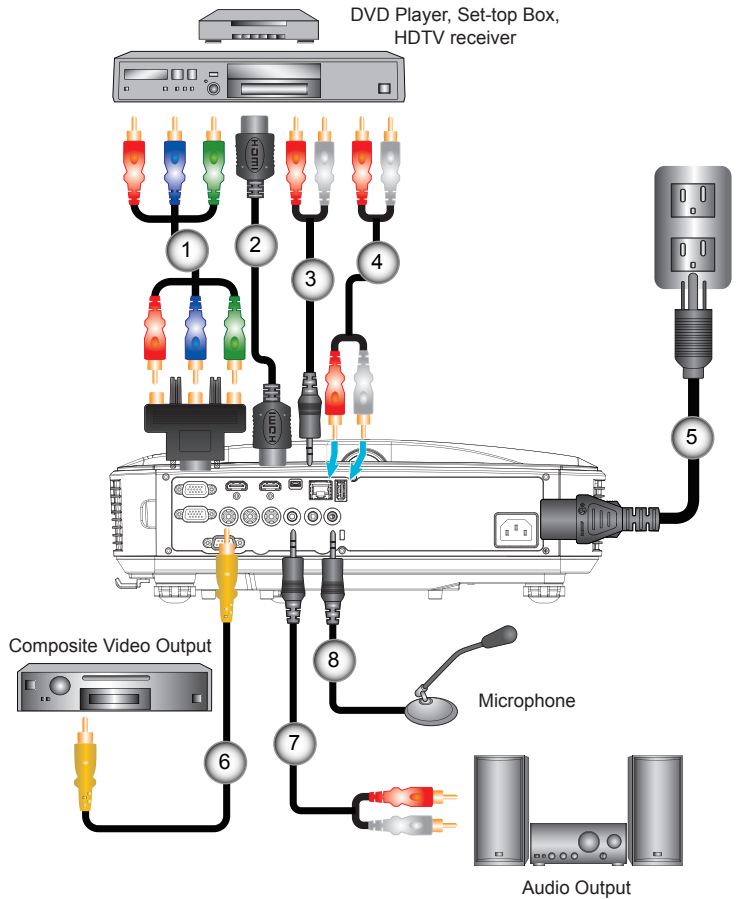

- ❖ Due to the difference in applications for each country, some regions may have different accessories.
- ❖ (\*) Optional accessory

1.....	*15-Pin to 3 RCA Component/HDTV Adaptor
2.....	*HDMI Cable
3.....	*Audio Cable
4.....	*Audio Cable/RCA
5.....	Power Cord
6.....	*Composite Video Cable
7.....	*Audio Cable/RCA
8.....	*Audio Input Cable

## Powering the Projector On / Off

### Powering On the Projector

1. Securely connect the power cord and signal cable. When connected, the POWER/STANDBY LED will turn Orange.
2. Turn on the lamp by pressing “” button either on the projector or on the remote. At this moment, the POWER/STANDBY LED will now turn Blue. ❶

The startup screen will display in approximately 10 seconds. The first time you use the projector, you will be asked to select the preferred language and power saving mode.

3. Turn on and connect the source that you want to display on the screen (computer, notebook, video player, etc). The projector will detect the source automatically. If not, push menu button and go to “OPTIONS”. Make sure that the “Source Lock” has been set to “Off”.
- ❖ If you connect multiple sources at the same time, press the “INPUT” button on the control panel or direct source keys on the remote control to switch between inputs.



❖ When the power mode is in standby mode (power consumption < 0.5W), the VGA output/ input and audio will be deactivated when the projector is in standby.



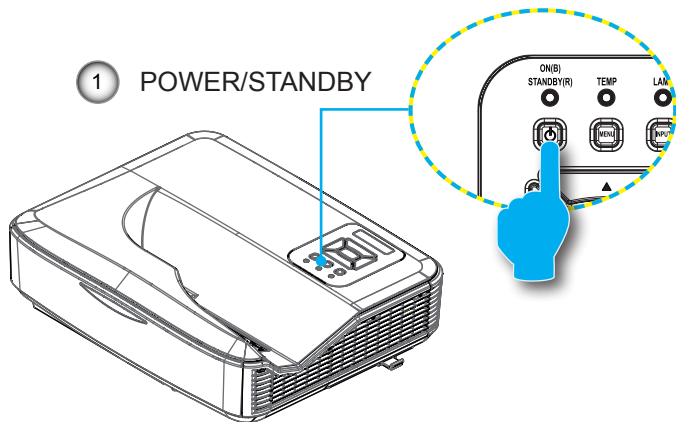

❖ Turn on the projector first and then select the signal sources.

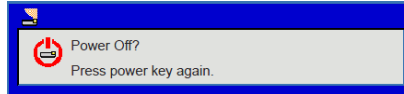

## Powering Off the Projector

1. Press the “” button on the remote control or on the control panel to turn off the projector. The following message will be displayed on the screen.



Press the “” button again to confirm otherwise the message will disappear after 10 seconds. When you press the “” button for the second time, the fan will start cooling the system and will shut down.

2. The cooling fans continue to operate for about 4 seconds for cooling cycle and the POWER/STANDBY LED will flash Orange. When the POWER/STANDBY LED lights solid Orange, the projector has entered standby mode.

If you wish to turn the projector back on, you must wait until the projector has completed the cooling cycle and has entered standby mode. Once in standby mode, simply press “” button to restart the projector.

3. Disconnect the power cord from the electrical outlet and the projector.

## Warning Indicator

When the warning indicators (see below) come on, the projector will automatically shutdown:



❖ Contact the nearest service center if the projector displays these symptoms.

- ❖ “LAMP” LED indicator is lit red and if “POWER/STANDBY” indicator flashes amber.
- ❖ “TEMP” LED indicator is lit red, this indicates the projector has overheated. Under normal conditions, the projector can be switched back on.
- ❖ “TEMP” LED indicator flashes red and if “POWER/STANDBY” indicator flashes amber.

Unplug the power cord from the projector, wait for 30 seconds and try again. If the warning indicator light up again, please contact your nearest service center for assistance.

## Adjusting the Projected Image

### Adjusting the Projector's Height

*The projector is equipped with elevator feet for adjusting the image height.*

1. Locate the adjustable foot you wish to modify on the underside of the projector.
2. Rotate the adjustable ring clockwise to raise the projector or counter clockwise to lower it. Repeat with the remaining feet as needed.

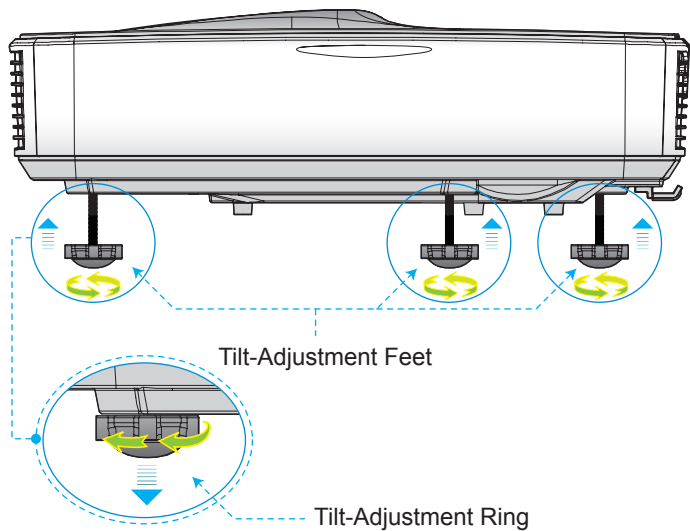

## Adjusting the Projector's Focus

To focus the image, slide the focus switch to left/right until the image is clear.

- ▶ 1080p series: The projector will focus at distances from 1.443 to 1.887 feet (0.437 to 0.572 meters).
- ▶ Ultra Wide series: The projector will focus at distances from 1.413 to 1.884 feet (0.428 to 0.571 meters).

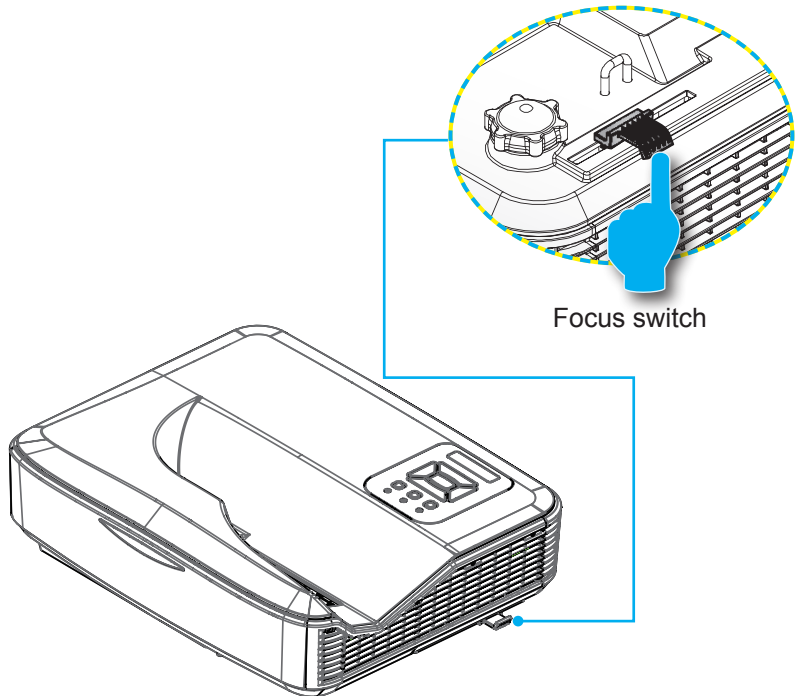



# Installation

## Adjusting Projection Image Size (Diagonal)

- ▶ 1080p series: Projection Image Size from 80" to 100" (2.03 to 2.54 meters).
- ▶ Ultra Wide series: Projection Image Size from 120" to 140" (3.05 to 3.56 meters).

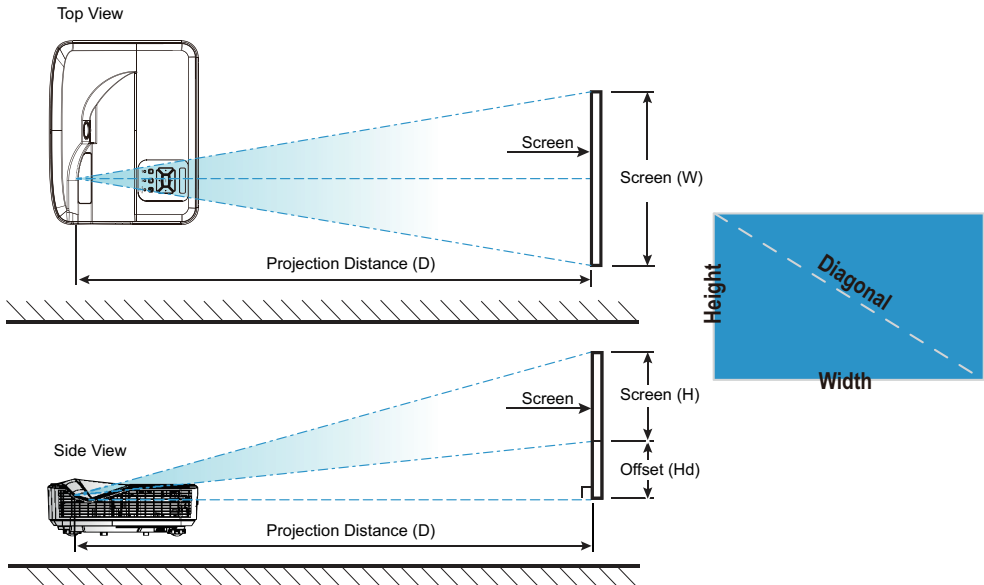

1080p

Diagonal length (inch) size of 16:9 Screen	Screen Size W x H				Projection Distance (D)				Offset (Hd)	
	(cm)		(inch)		(cm)		(inch)		(cm)	(inch)
	Width	Height	Width	Height	wide	tele	wide	tele		
87	192.6	108.3	75.8	42.6	23.3	NA	9.2	NA	28.9	11.4
90	199.2	112.1	78.4	44.1	24.9	NA	9.8	NA	29.6	11.7
95	210.3	118.3	82.8	46.6	27.7	NA	10.9	NA	30.9	12.2
100	221.4	124.5	87.2	49.0	30.5	NA	12.0	NA	32.2	12.7
102	225.8	127.0	88.9	50.0	31.6	NA	12.4	NA	32.7	12.9

# Installation

## Ultra Wide

Diagonal length (inch) size of 16:6 Screen	Screen Size W x H				Projection Distance (D)				Offset (Hd)	
	(cm)		(inch)		(cm)		(inch)		(cm)	(inch)
	Width	Height	Width	Height	wide	tele	wide	tele		
120	285.4	107.0	112.4	42.1	46.5	NA	18.3	NA	36.9	14.5
125	297.3	111.5	117.0	43.9	49.5	NA	19.5	NA	38.2	15.0
130	309.2	115.9	121.7	45.6	52.4	NA	20.6	NA	39.5	15.6
135	321.1	120.4	126.4	47.4	55.4	NA	21.8	NA	40.8	16.1
140	333.0	124.9	131.1	49.2	58.4	NA	23.0	NA	42.0	16.5

❖ This table is for user's reference only.

## Control Panel & Remote Control

### Control Panel

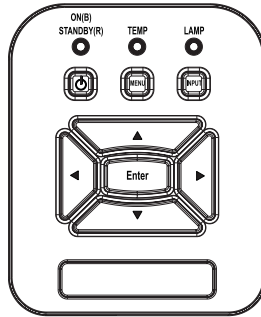

#### Using the Control Panel

POWER		Refer to the “Power On/Off the Projector” section on pages 13-14.
Enter		Press “Enter” to confirm your item selection.
INPUT		Press “INPUT” to select an input signal.
MENU		Press “MENU” to launch the on-screen display (OSD) menu. To exit OSD, press “MENU” again.
Four Directional Select Keys		Use ▲ ▼ ◀ ▶ to select items or make adjustments to your selection.
LAMP LED		Refer to the LED indicator of the projector light source status.
TEMP LED		Refer to the LED indicator of the projector temperature status.
ON/STANDBY LED		Refer to the LED indicator of the projector power status.

# User Controls

## Remote Control

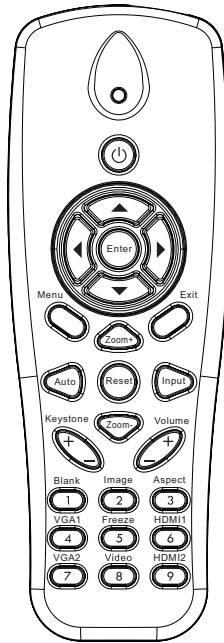

### Using the Remote Control

Infrared transmitter	Sends signals to the projector.
LED	LED Indicator.
Power 	Refer to the “Power On/Off the Projector” section on pages 15-16.
Exit	Press “Exit” to close the OSD menu.
Zoom in	Zoom in the projector display.
Reset	Return the adjustments and settings to the factory default values. (except for lamp counter)
Zoom out	Zoom out the projector display.
Enter	Confirm your item selection.
Source	Press “Source” to select an input signal.
Auto	Automatically synchronizes the projector to the input source.
Four Directional Select Keys	Use ▲ ▼ ◀ ▶ to select items or make adjustments to your selection.
Keystone +/-	Adjust image distortion caused by tilting the projector.
Volume +/-	Adjust to increase / decrease the volume.
Aspect ratio	Use this function to choose your desired aspect ratio.
Menu	Press “Menu” to launch the on-screen display (OSD) menu. To exit OSD, press “Menu” again.

# User Controls

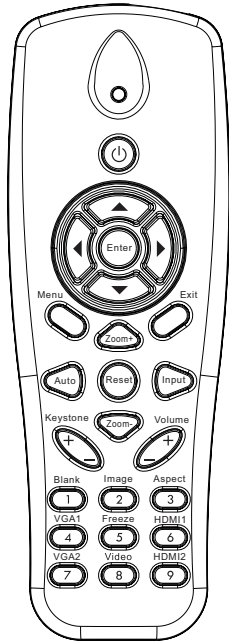

## Using the Remote Control

VGA1	Press "VGA1" to choose VGA IN 1 connector.
Blank screen	Momentarily turns off/on the audio and video.
HDMI1	Press "HDMI1" to choose HDMI IN 1 connector.
HDMI2	Press "HDMI2" to choose HDMI IN 2 connector.
VGA2	Press "VGA2" to choose VGA IN 2 connector.
Video	Press "Video" to choose Composite video source.
Screen freeze	Pause the screen image. Press again to resume the screen image.
Image	Select the display mode from Bright, PC, Movie, Game, and User.

## On-screen Display Menus

The Projector has multilingual On-screen Display menus that allow you to make image adjustments and change a variety of settings.

### How to operate

1. To open the OSD menu, press “Menu” on the Remote Control or Projector Keypad.
2. When OSD is displayed, use the ▲ ▼ keys to select any item in the main menu. While making a selection on a particular page, press the ► or “Enter” key to enter sub menu.
3. Use the ▲ ▼ keys to select the desired item and adjust the settings using the ◀▶ key.
4. Select the next item to be adjusted in the sub menu and adjust as described above.
5. Press “Enter” to confirm, and the screen will return to the main menu.
6. To exit, press “Menu” again. The OSD menu will close and the projector will automatically save the new settings.

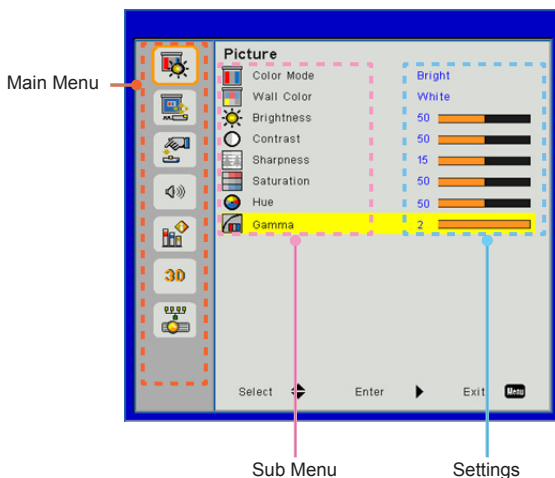

## Picture

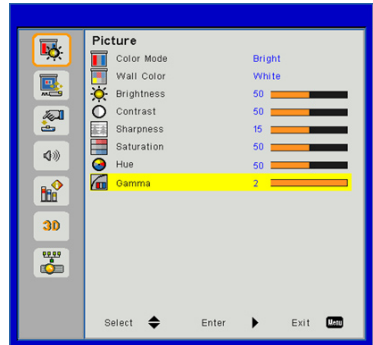

### Color Mode

There are many factory presets optimized for various types of images. Use the ◀ or ▶ button to select the item.

- ▶ Bright: For brightness optimization.
- ▶ PC: For meeting presentation.
- ▶ Movie: For playing video content.
- ▶ Game: For game content.
- ▶ User: Memorize user's settings.

### Wall Color

Use this function to obtain an optimized screen image according to the wall color. You can select from "White", "Light Yellow", "Light Blue", "Pink", and "Dark Green".

### Brightness

Adjust the brightness of the image.

- ▶ Press the ◀ button to darken image.
- ▶ Press the ▶ button to brighten image.

### Contrast

The Contrast controls the difference between the lightest and darkest parts of the picture. Adjusting the contrast changes the amount of black and white in the image.

- ▶ Press the ◀ button to decrease the contrast.
- ▶ Press the ▶ button to increase the contrast.

# User Controls



- ❖ “Sharpness”, “Saturation” and “Hue” functions are only supported under video mode.

## Sharpness

Adjust the sharpness of the image.

- ▶ Press the ◀ button to decrease the sharpness.
- ▶ Press the ▶ button to increase the sharpness.

## Saturation

Adjust a video image from black and white to fully saturated color.

- ▶ Press the ◀ button to decrease the amount of saturation in the image.
- ▶ Press the ▶ button to increase the amount of saturation in the image.

## Hue

Adjust the color balance of red and green.

- ▶ Press the ◀ button to increase the amount of green in the image.
- ▶ Press the ▶ button to increase the amount of red in the image.

## Gamma

This allows you to adjust the gamma value to obtain the better image contrast for the input.



## Screen



### Aspect Ratio

- ▶ Auto: Keep the image with original width-height ratio and maximize the image to fit native horizontal or vertical pixels.
- ▶ 4:3: The image will be scaled to fit the screen and displayed using a 4:3 ratio.
- ▶ 16:9: The image will be scaled to fit the width of the screen and the height adjusted to display the image using a 16:9 ratio.
- ▶ 16:10: The image will be scaled to fit the width of the screen and the height adjusted to display the image using a 16:10 ratio. (only for SSI 1080p).
- ▶ UWHD: The image will be scaled to fit the width of the screen and the height adjusted to display the image using a 16:6 ratio (only for Ultrawide).



- ❖ “H. Position” and “V. Position” ranges will depend on input source.

### Phase

Synchronize the signal timing of the display with the graphic card. If the image appears to be unstable or flickers, use this function to correct it.

### Clock

Adjust to achieve an optimal image when there is a vertical flicker in the image.

### H. Position

- ▶ Press the ◀ button to move the image left.
- ▶ Press the ▶ button to move the image right.

## V. Position

- ▶ Press the ◀ button to move the image down.
- ▶ Press the ▶ button to move the image up.

## Digital Zoom

- ▶ Press the ◀ button to reduce the size of an image.
- ▶ Press the ▶ button to magnify an image on the projection screen.

## V Keystone

Press the ◀ or ▶ button to adjust image distortion vertically. If the image looks trapezoidal, this option can help make the image rectangular.

## Ceiling Mount

- ▶ Front: The image is projected straight on the screen.
- ▶ Front Ceiling: This is the default selection. When selected, the image will turn upside down.
- ▶ Rear: When selected, the image will appear reversed.
- ▶ Rear Ceiling: When selected, the image will appear reversed in upside down position.

## Setting



### Language

Choose the multilingual OSD menu. Press the ◀ or ▶ button into the sub menu and then use the ▲ or ▼ button to select your preferred language. Press ▶ on the remote control to finalize the selection.



### Menu Location

Choose the menu location on the display screen.

### Closed Caption

Use this function to enable close caption menu. Select an appropriate closed captions option: Off, CC1, CC2, CC3, and CC4.

### VGA Output (Standby)

Choose "On" to enable VGA OUT connection.

## LAN (Standby)

Choose “On” to enable LAN connection. Choose “Off” to disable LAN connection.

## VGA B (Function)

- ▶ Input: Choose “Input” to let the VGA port works as a VGA input function.
- ▶ Output: Choose “Output” to enable the VGA Out function once the projector is powered on.

## Test Pattern

Display a test pattern.

## Reset

Choose “Yes” to return the parameters on all menus to the factory default settings.

## Volume

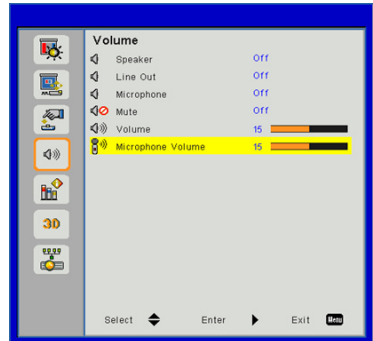

### Speaker

- ▶ Choose “On” to enable the speaker.
- ▶ Choose “Off” to disable the speaker.

### Line Out

- ▶ Choose “On” to enable the line out function.
- ▶ Choose “Off” to disable the line out function.

### Microphone

- ▶ Choose “On” to enable the microphone.
- ▶ Choose “Off” to disable the microphone.

### Mute

- ▶ Choose “On” to turn mute on.
- ▶ Choose “Off” to turn mute off.

### Volume

- ▶ Press the ◀ button to decrease the volume.
- ▶ Press the ▶ button to increase the volume.

### Microphone Volume

- ▶ Press the ◀ button to decrease the microphone volume.
- ▶ Press the ▶ button to increase the microphone volume.

## Options

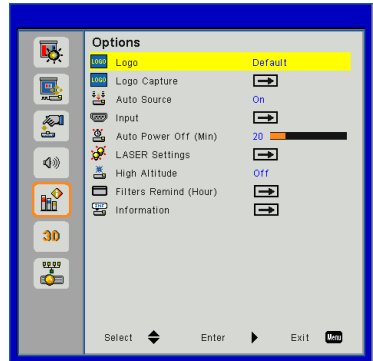

### Logo

Use this function to set the desired startup screen. If changes are made they will take effect the next time the projector is powered on.

- ▶ Default: The default startup screen.
- ▶ User: Use stored picture from “Logo Capture” function.



- ❖ For successful logo capture, please ensure that the on-screen image does not exceed the projector's native resolution. (WXGA:1280x800).
- ❖ “Logo Capture” is not available when 3D is enabled.
- ❖ Before active this function, it is recommended that “Aspect Ratio” is set to the “Auto”.

### Logo Capture

Press ▶ button to capture an image of the picture currently displayed on screen.

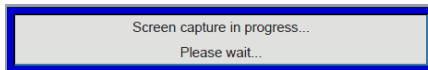

### Auto Source

- ▶ On: The projector will search for other signals if the current input signal is lost.
- ▶ Off: The projector will only search current input connection.

### Input

Press ▶ button to enable/disable input sources. The projector will not search for inputs that are not selected.

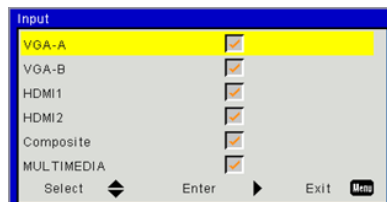



- ❖ “Dynamic Black” is available when “Color Mode” is set to “Movie”.
- ❖ When “Dynamic Black” is available, “Laser Power Mode” selection is not available.

## Auto Power Off (Min)

Sets the countdown timer interval. The countdown timer will start, when there is no signal being sent to the projector. The projector will automatically power off when the countdown has finished (in minutes).

## Laser Settings

Refer to page 32.

## Dynamic Black

- ▶ On: The pictures with the optimum contrast will be displayed by automatically providing signal compensation to suit the pictures concerned.
- ▶ Off: Turn off this function.

## High Altitude

- ▶ On: The built-in fans run at high speed. Select this option when using the projector at altitudes above 2500 feet/762 meters or higher.
- ▶ Off: The built-in fans automatically run at a variable speed according to the internal temperature.

## Filters Remind (Hour)

- ▶ Filters Remind (Hour): Set the filter reminder time.
- ▶ Cleaning Up Remind: Select “Yes” to reset the dust filter hour counter after replacing or cleaning the dust filter.

## Information

Display the projector information for model name, SNID, source, resolution, software version, and aspect ratio on the screen.

## Options | Laser Settings

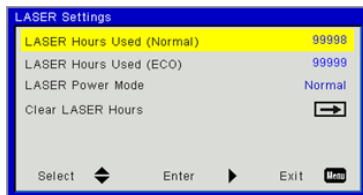

### Laser Hours Used (Normal)

Display the projection time of normal mode.

### Laser Hours Used (ECO)

Display the projection time of ECO mode.

### Laser Power Mode

- ▶ Normal: Normal mode.
- ▶ ECO: Use this function to dim the projector lamp which will lower power consumption and extend the lamp life.

### Clear Laser Hours

Choose “Yes” to reset the laser hour counter.



## 3D

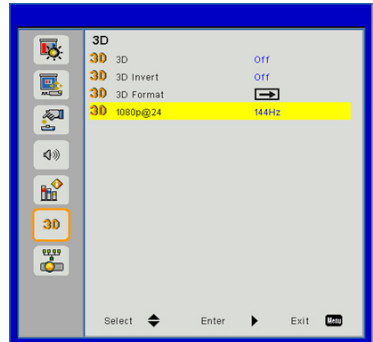

- ❖ “Frame Sequential” is supported the DLP Link 3D input signals from VGA / HDMI connector.
- ❖ “Frame Sequential” / “Field Sequential” are supported the HQFS 3D input signals from Composite/ S-Video connector connector.
- ❖ “Frame Packing” / “Side-by-Side(Half)” / “Top and Bottom” are supported from HDMI 1.4a 3D input signals.

### 3D

- ▶ Auto: When a HDMI 1.4a 3D timing identification signal is detected, the 3D image is selected automatically.
- ▶ Choose “On” to enable 3D function.
- ▶ Choose “Off” to disable 3D function.

### 3D Invert

If you see a discrete or overlapping image while wearing DLP 3D glasses, you may need to execute “Invert” to get best match of left/ right image sequence to get the correct image.

### 3D Format

Use this feature to select the 3D format. Options are: “Frame Packing”, “Side-by-Side (Half)”, “Top and Bottom”, “Frame Sequential”, and “Field Sequential”.

### 1080p@24

Use this feature to select 96 or 144Hz refresh rate as using 3D glasses in the 1080p @ 24 frame packing.

## Multimedia

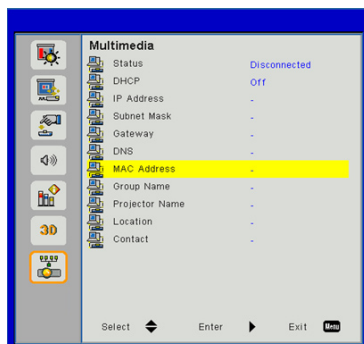

- ❖ IP, Subnet Mask, Gateway, and DNS configuration assignment please access to web control page. How to access web control page please refer to page 36.

### Status

Display the network connection status.

### DHCP

Configure the DHCP settings.

- ▶ On: Choose “On” to let the projector to obtain an IP address automatically from your network.
- ▶ Off: Choose “Off” to assign IP, Subnet Mask, Gateway, and DNS configuration manually.

### IP Address

Display an IP address.

### Subnet Mask

Display the subnet mask number.

### Gateway

Display the default gateway of the network connected to the projector.

### DNS

Display the DNS number.

### MAC Address

Display the MAC address.

## Group Name

Display the group name.

## Projector Name

Display the projector name.

## Location

Display the projector location.

## Contact

Display the contact information.

# User Controls

## How to use web browser to control your projector

1. Turn on DHCP to allow a DHCP server to automatically assign an IP, or manually enter the required network information.

Status	Connect
DHCP	Off
IP Address	172.16.1.42
Subnet Mask	255.255.255.0
Gateway	172.16.1.254
DNS	172.16.1.1

2. Then choose apply and press **OK** button to complete the configuration process.
3. Open your web browser and type in IP Address from the OSD LAN screen then the web page will display as below:



- ❖ When you used the projector IP address, you will not link to your service server.

4. Based on network web-page for the input-string in [tools] tab, the limitation for Input-Length is in the below list ("space" and the other punctuation key included):

Category	Item	Input-Length (characters)
Crestron Control	IP Address	15
	IP ID	2
	Port	5
Projector	Projector Name	10
	Location	9
	Assigned To	9
Network Configuration	DHCP (Enabled)	(N/A)
	IP Address	15
	Subnet Mask	15
	Default Gateway	15
User Password	DNS Server	15
	Enabled	(N/A)
	New Password	15
Admin Password	Confirm	15
	Enabled	(N/A)
	New Password	15
	Confirm	15

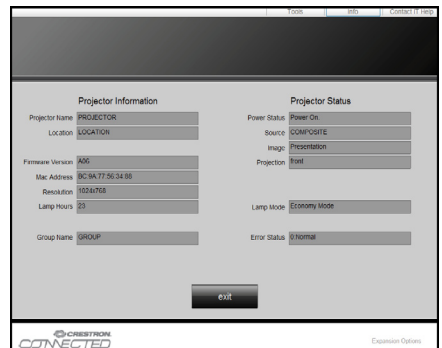

# User Controls

**When making a direct connection from your computer to the projector**

Step 1: Find an IP Address (192.168.0.100) from LAN function of projector.

IP Address	192	168	000	100
------------	-----	-----	-----	-----

Step 2: Select apply and press “Enter” button to submit function or press “menu” key to exit.

Step 3: To open Network Connections, click **Start**, click **Control Panel**, click **Network and Internet Connections**, and then click **Network Connections**. Click the connection you want to configure, and then, under **Network Tasks** , click **Change settings of this connection**.

Step 4: On the **General** tab, under **This connection uses the following items**, click **Internet Protocol (TCP/IP)**, and then click “Properties.”

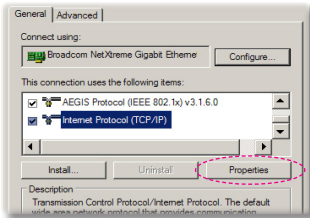

Step 5: Click **Use the following IP address**, and type in as below:

- 1) IP address: 192.168.0.100
- 2) Subnet mask: 255.255.255.0
- 3) Default gateway: 192.168.0.254

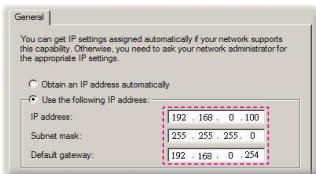

Step 6: To open Internet Options, click IE web browser, click Internet Options, click the **Connections** tab and click “LAN Settings...”

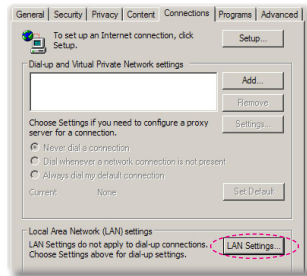

Step 7: The **Local Area Network (LAN) Setting** dialog box appears. In the **Proxy Server** area, cancel the **Use a proxy server for your LAN** check box, then click “OK” button twice.

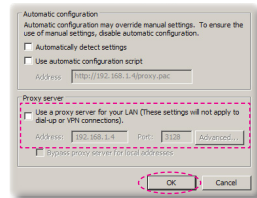

Step 8: Open your IE and type in the IP address of 192.168.0.100 in the URL then press “Enter” key.

# User Controls

## Crestron RoomView Control Tool

Crestron RoomView™ provides a central monitoring station for 250+ control systems on a single Ethernet network (more are possible, the number depends on the combination of IP ID and IP address). Crestron RoomView monitors each projector, including projector's online status, system power, lamp life, network setting and hardware faults, plus any custom attribute as defined by the Administrator. The Administrator can add, delete, or edit room information, contact information and events, which are logged automatically by the software for all users. (Operation UI as following image)

### 1. Main Screen

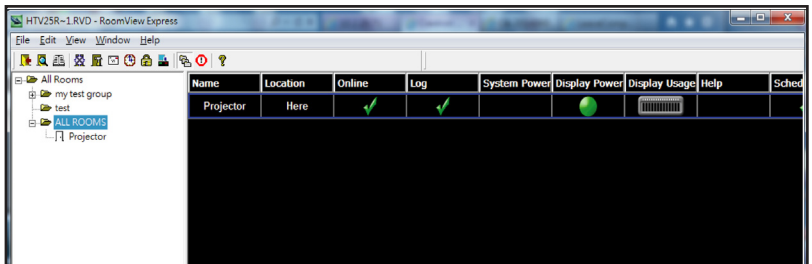

### 2. Edit Room



❖ Crestron RoomView's function is set according to the products' models and specifications.

Room Information

Name: crestron room Phone: \_\_\_\_\_

Location: \_\_\_\_\_ e-Control Link: \_\_\_\_\_ Browse...

IP Address: 192.168.0.101 Video Link: \_\_\_\_\_

IPID/IP Port: 03 | 41794

DHCP Enabled  SSL

External Gateway Username: \_\_\_\_\_

0.0.0.0 Password: \_\_\_\_\_

Comment

Save Room Save As Help

OK Cancel Apply

## 3. Edit Attribute

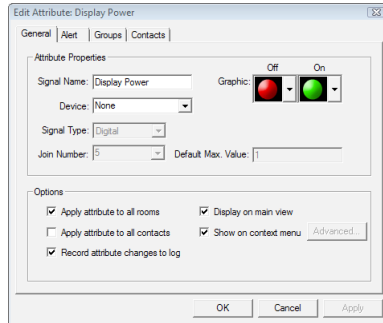

## 4. Edit Event

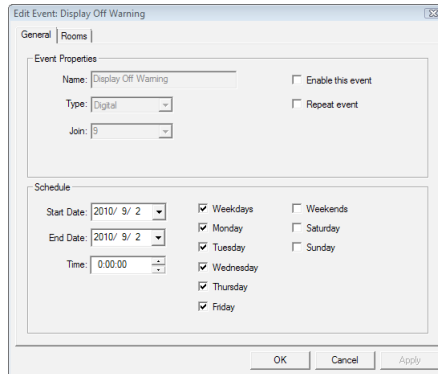

**For further information, please visit:**

**<http://www.crestron.com> & [www.crestron.com/getroomview](http://www.crestron.com/getroomview).**

## Accessing Multimedia Files

This projector supports two methods to project the media files (photos, videos, music, documents) stored on following devices:

- a. via Wireless dongle (optional) - wirelessly access the media files stored on your mobile phone, tablet PC, notebook, or desktop.
- b. via USB flash drive - directly access the media files stored in the device.

### How to access Multimedia mode

1. Plug a wireless dongle or a USB flash drive into the USB connector at the back of projector.

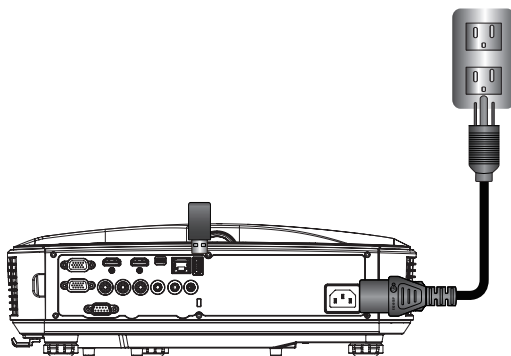

2. Press “INPUT” on the remote control or on the control panel to turn on the projector. When the Input menu appears, press the ▲ ▼ keys to select “Multimedia” and the “Enter” key to confirm.



## Mobile Display

To access the media files stored on your mobile device or tablet PC, do the following:

1. On **Multimedia** menu, select **Mobile/Tablet**.

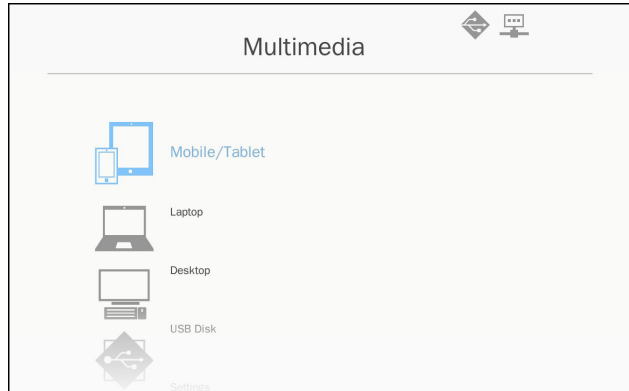

2. On your mobile device or tablet PC, download “EZview” application App Store (iOS) or Play Store (Android).

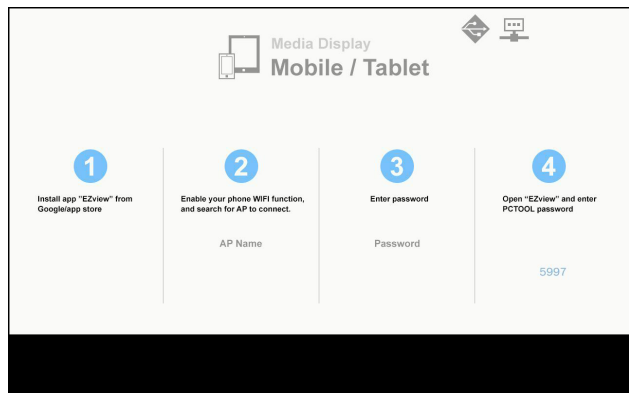

3. Enable your mobile device or tablet PC WiFi function, and search the AP name listed in the Wi-Fi network list.
4. On the initial connection, you will be prompted to enter a password. Enter the password.
5. Launch “EZview” application and enter the PCTOOL password.
6. Wait until the connection is established. The media files on your mobile device or tablet PC can be accessed using the projector.

## Laptop Display

To access the media files stored on your laptop/notebook, do the following:

1. On **Multimedia** menu, select **Laptop**.

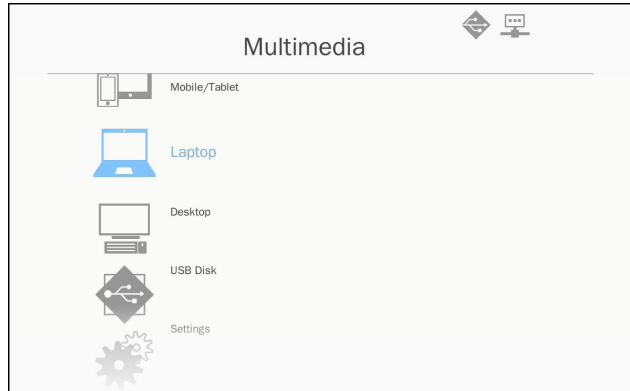

2. Enable your laptop/notebook WiFi function, and search the AP name listed in the Wi-Fi network list.

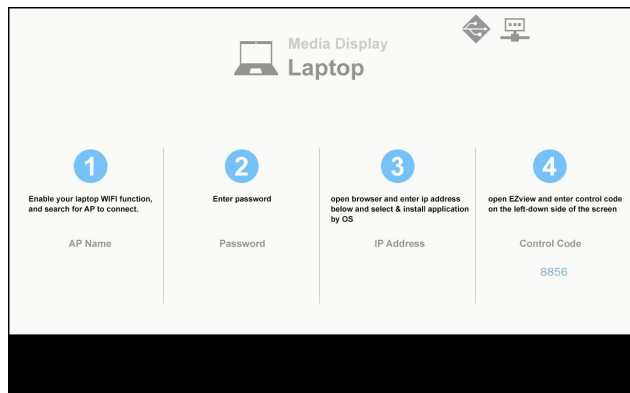

3. On the initial connection, you will be prompted to enter a password. Enter the password.
4. Open your web browser and enter the IP address. Then select "Wifi" on the left side of the screen and install application required by the operation system.
5. Launch "EZview" application and enter the control code shown on the right-bottom side of the screen.

6. Wait until the connection is established. The media files on your laptop/notebook can be accessed using the projector.

## Desktop Display

To access the media files stored on your desktop, do the following:

1. On **Multimedia** menu, select **Desktop**.

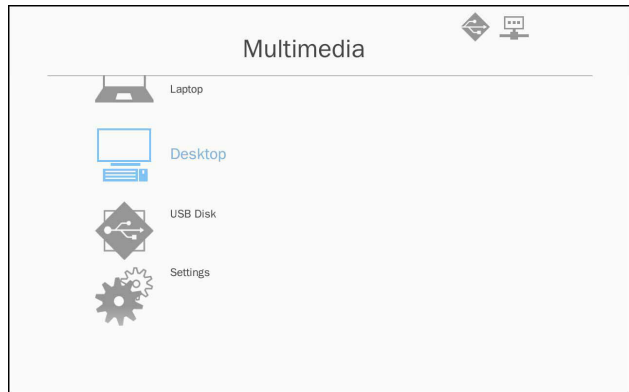

2. Open your web browser and enter the IP address. Then select "Wifi" on the left side of the screen and install application required by the operation system.

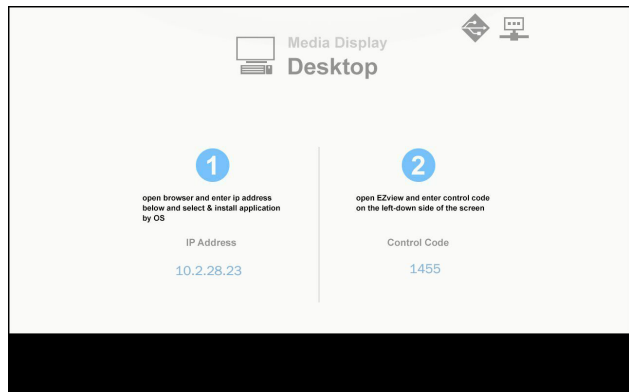

# Multimedia

3. Launch “EZview” application and enter the control code shown on the right-bottom side of the screen.
4. Wait until the connection is established. The media files on your desktop can be accessed using the projector.

## USB Storage Display

To access the media files stored on your USB flash drive, do the following:

### Supported File Format

Multimedia Category	File Format
Photo	BMP, JPG, PNG
Music	MP3, WMA
Video	AVI, MOV, MP4, RM, RMVB, DAT, MPG, ISO, TS, MKV, VOB, and WMV
Document	WORD, EXCEL, PPT*, PDF

1. On **Multimedia** menu, select **USB Disk**.



- ❖ PowerPoint animations are not supported.
- ❖ Details about MMA support list please refer to Appendices.

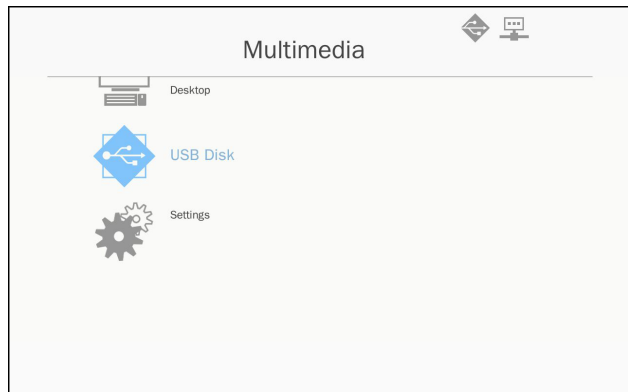

2. Use the ▲ ▼ keys to select the file category and press the “Enter” key.

# Multimedia

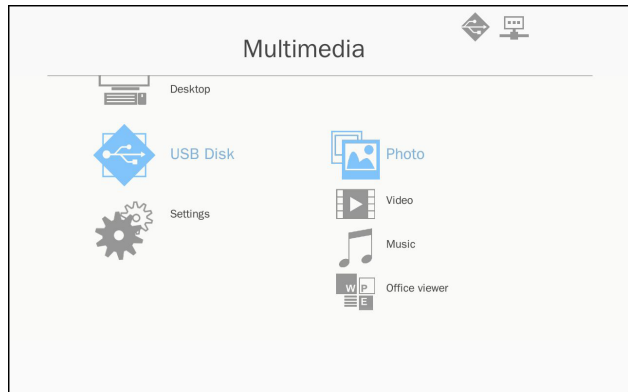

3. Use the ▲ ▼ keys to select the file to view/play and press the “Enter” key to confirm.

## Configuring Multimedia Settings

To change the settings, do the following:

1. On **Multimedia** menu, select **Settings**.

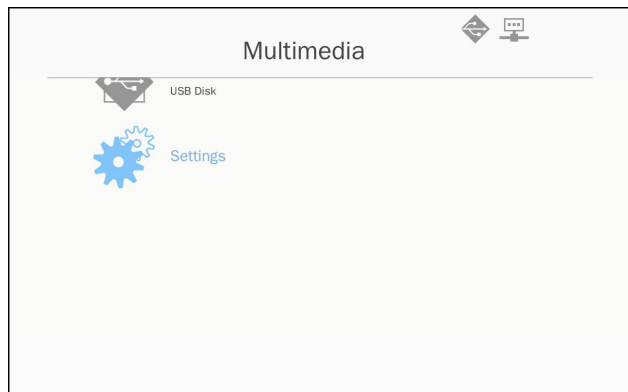

# Multimedia

2. Use the ▲ ▼ keys to select the desired menu option and press the “Enter” key to enter the submenu.

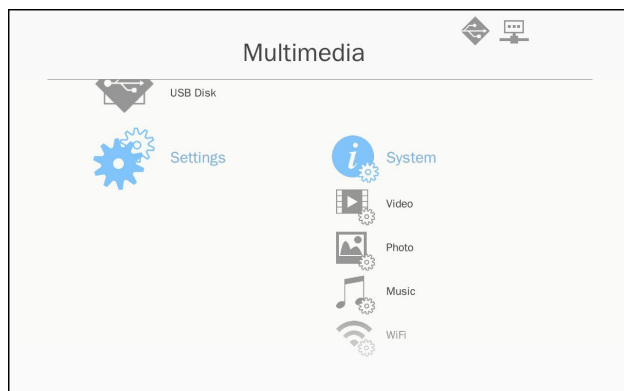

- ▶ System: Select this option to view the firmware version and update firmware.
  - ▶ Video: Select this option to change the display ratio and set the repeat mode.
  - ▶ Photo: Select this option to change the display ratio, slideshow pattern, and slideshow duration.
  - ▶ Music: Select this option to set the repeat mode.
  - ▶ WiFi: Select this option to configure the Wi-Fi connection.
3. Use the ▲ ▼ keys to select the adjust/select the setting and press the “Enter” key to confirm.

## Installing and Cleaning the Optional Dust Filter

We recommend you clean the dust filter every 500 hours of operation, or more often if you are using the projector in a dusty environment.

When the warning message appears on the screen, do the following to clean the air filter:

The usage time of the dust filter is reached.  
Please clean the dust filters for better performance.



- ❖ The optional dust filter should be used in dusty environments.
- ❖ If the dust filter is installed, a proper maintenance will prevent overheating and projector malfunction.
- ❖ The dust filter is optional.
- ❖ The specific interfaces are selected in terms of the specifications of types.

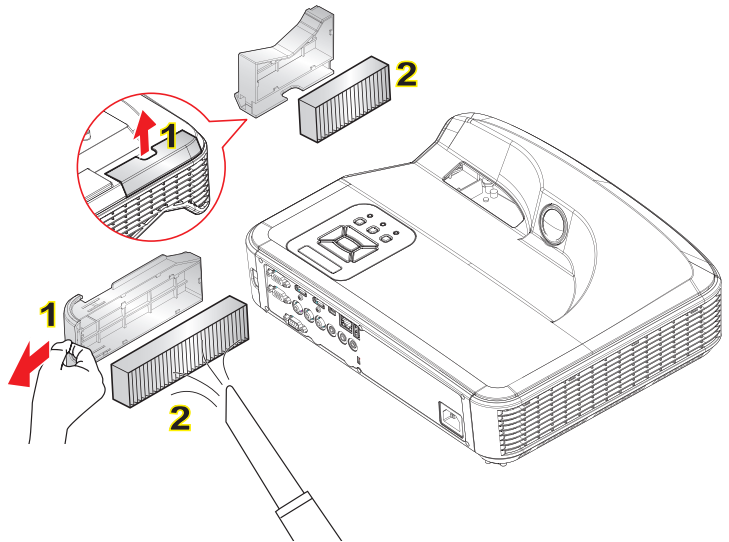

### ○ Air Filter Cleaning Procedure: ○

1. Switch off the power to the projector by pressing the “” button.
2. Disconnect the power cord.
3. Pull out the dust filter, as shown in the illustration. **1**
4. Carefully remove the dust filter. Then clean or change the filter. **2**  
To install the filter, reverse the previous steps.
5. Turn on the projector and reset the filter usage counter after the dust filter is replaced.

# Appendices

## MMA Support List

### Image

Image Format	Profile	Color Space	Size Limitation
JPEG	Baseline	YUV400	8000 x 6000
		YUV420	8000 x 6000
		YUV422	8000 x 6000
		YUV440	8000 x 6000
		YUV444	8000 x 6000
	Progressive	YUV400	Width <= 10240 & height <= 6400
		YUV420	
		YUV422	
		YUV440	
		YUV444	
BMP	No Limit	No Limit	No Limit

### Audio

Audio Format	Sample Rate (KHz)	Bit Rate (Kbps)
MP1/MP2/MP3	8-48	8-320
WMA	22-48	5-320
OGG	8-48	64-320
ADPCM-WAV	8-48	32-384
PCM-WAV	8-48	128-1536



# Appendices

## Video

File Extensions	Audio/ Video	Codec	Profile/Level Support	Explanation
.avi .mkv	Video	MJPEG	Up to 1080P 30fps 80Mbps	
		H.264/AVC	Up to High Profile , Levels 1- 4.1 (1080P 30fps 25Mbps)	Support less than 6 reference frames
		XVID	Up to Advance Simple profile (1080P 30fps 30Mbps)	
		WMV3 (WMV Ver9)	Up to Main Profile; Low, Medium Level (1080P 30fps 25Mbps)	
		MPEG2	Main profile, Low and Main Levels (1080P 30fps 30Mbps)	
		MPEG4	Advanced Simple Profile (frame picture) , Levels 0-5 (1080P 30fps 30Mbps)	
.avi .mkv	Video	VC-1	Simple and Main Profile; Low, Medium and High Levels (1080P 30fps 25Mbps)	Not Support VC-1 Advance Profile
	Audio	MPEG-1 Layer I, II		
		MPEG-1 Layer III (mp3)		
		PCM		
		ADPCM		

# Appendices

.ts	Video	MPEG2	Main profile, Low and Main Levels (1080P 30fps 30Mbps)	
		H.264/AVC	Up to High Profile , Levels 1- 4.1 (1080P 30fps 25Mbps)	Support less than 6 reference frames
.ts	Video	MPEG-1 Layer I, II		
		MPEG-1 Layer III (mp3)		
		LPCM		
.dat .vob .mpg .mpeg	Video	MPEG1	Main profile, Low and Main Levels (1080P 30fps 30Mbps)	D-picture not support
		MPEG2	Main profile, Low and Main Levels (1080P 30fps 30Mbps)	
	Audio	MPEG-1 Layer I, II		
		MPEG-1 Layer III (mp3)		
		LPCM		
.mov .mp4	Video	MPEG4	Advanced Simple Profile (frame picture) , Levels 0-5 (1080P 30fps 30Mbps)	
		H.264/AVC	Up to High Profile, Levels 1- 4.1 (1080P 30fps 25Mbps)	Support less than 6 reference frames
	Audio	AMR		
		PCM		
		ADPCM		

# Appendices

.wmv	Video	WMV3 (WMV Ver9)	Up to Main Profile; Low, Medium Level (1080P 30fps 25Mbps)	
	Audio	WMA2 (WMA Ver9 & Ver9.1)		Not Support WMA Ver9 Pro

## Subtitle

Format	Font	Subtitle Size
Standard SRT	UTF-8 / UTF-16	8bits up to 1280 x 800
SMI		
SSA/ASS		

Note: DO NOT support mixed code in subtitle files.

## Office Viewer

File Format	Support Version	Pages/ Lines Limitation	Size Limitation	Comment
Adobe PDF	PDF 1.0	Up to 1000 pages (One File)	Up to 75MB	
	PDF 1.1			
	PDF 1.2			
	PDF 1.3			
	PDF 1.4			
MS PowerPoint	British PowerPoint 97.	Up to 1000 pages (One File)	Up to 19MB	No support Slide Show order
	PowerPoint 2000, 2002, 2003.			
	PowerPoint 2007(.pptx).			
	PowerPoint 2010(.pptx),.			
	Office XP PowerPoint.			
	PowerPoint presentation-2003 and earlier(.ppx)			
PowerPoint presentation-2007 and 2010(.ppsx)				

# Appendices

MS Word	British Word95	Because office viewer does not load all pages of MS Word file at the same time, there are no obvious limitations of page and line.	Up to 100MB	Not support Bold Text in Simple Chinese front
	Word97, 2000, 2002, 2003			
	Word 2007 (.docx), 2010 (.docx)			
MS Excel	British Excel 95	Row Limit: up to 595	Up to 15MB	Not support password-protected sheets
	Excel 97, 2000, 2002, 2003	Row Limit: up to 595		
	Excel 2007 (.xlsx), 2010 (.xlsx)	Sheet: up to 100		
	Office XP Excel			

Note: Any one of three limitations above can not appear on one excel file simultaneously

## Storage

Storage	Device type	File system	File&Dir Level
Internal Memory	TLC/MLC/SLC 8/12/24/40/60 bit ECC NAND	FAT16, FAT32 NTFS, ExFAT	Support Max 999 directories and Max 9,999 Files Support at most 10th level directory
USB	USB Flash,USB-HardDisk		
SD Card	SDHC,SDXC		

Not recommend to connect with the Portable Hard Drive over 250GB

## Compatibility Modes

### ► VGA Analog

a. PC signal			
Modes	Resolution	V. Frequency [Hz]	H. Frequency [Hz]
VGA	640x480	60	31.5
	640x480	67	35.0
	640x480	72	37.9
	640x480	75	37.5
	640x480	85	43.3
	640x480	120	61.9
IBM	720x400	70	31.5
SVGA	800x600	56	35.1
	800x600	60	37.9
	800x600	72	48.1
	800x600	75	46.9
	800x600	85	53.7
	800x600	120	77.4
Apple, MAC II	832x624	75	49.1
XGA	1024x768	60	48.4
	1024x768	70	56.5
	1024x768	75	60.0
	1024x768	85	68.7
	1024x768	120	99.0
Apple, MAC II	1152x870	75	68.7
SXGA	1280x1024	60	64.0
	1280x1024	72	77.0
	1280x1024	75	80.0
QuadVGA	1280x960	60	60.0
	1280x960	75	75.2
SXGA+	1400x1050	60	65.3
UXGA	1600x1200	60	75.0

# Appendices

b. Extended wide timing			
Modes	Resolution	V. Frequency [Hz]	H. Frequency [Hz]
WXGA	1280x720	60	44.8
	1280x800	60	49.6
	1366x768	60	47.7
	1440x900	60	59.9
WSXGA+	1680x1050	60	65.3
c. Component signal			
Modes	Resolution	V. Frequency [Hz]	H. Frequency [Hz]
480i	720x480 (1440x480)	59.94(29.97)	15.7
576i	720x576 (1440x576)	50(25)	15.6
480p	720x480	59.94	31.5
576p	720x576	50	31.3
720p	1280x720	60	45.0
	1280x720	50	37.5
1080i	1920x1080	60(30)	33.8
	1920x1080	50(25)	28.1
1080p	1920x1080	23.98/24	27.0
	1920x1080	60	67.5
	1920x1080	50	56.3

# Appendices

## ▶ HDMI Digital

a. PC signal			
Modes	Resolution	V. Frequency [Hz]	H. Frequency [Hz]
VGA	640x480	60	31.5
	640x480	67	35.0
	640x480	72	37.9
	640x480	75	37.5
	640x480	85	43.3
	640x480	120	61.9
IBM	720x400	70	31.5
SVGA	800x600	56	35.1
	800x600	60	37.9
	800x600	72	48.1
	800x600	75	46.9
	800x600	85	53.7
	800x600	120	77.4
Apple, MAC II	832x624	75	49.1
XGA	1024x768	60	48.4
	1024x768	70	56.5
	1024x768	75	60.0
	1024x768	85	68.7
	1024x768	120	99.0
Apple, MAC II	1152x870	75	68.7
SXGA	1280x1024	60	64.0
	1280x1024	72	77.0
	1280x1024	75	80.0
QuadVGA	1280x960	60	60.0
	1280x960	75	75.2
SXGA+	1400x1050	60	65.3
UXGA	1600x1200	60	75.0

# Appendices

b. Extended wide timing			
Modes	Resolution	V. Frequency [Hz]	H. Frequency [Hz]
WXGA	1280x720	60	44.8
	1280x800	60	49.6
	1366x768	60	47.7
	1440x900	60	59.9
WSXGA+	1680x1050	60	65.3
c. Video signal			
Modes	Resolution	V. Frequency [Hz]	H. Frequency [Hz]
480p	640x480	59.94/60	31.5
480i	720x480 (1440x480)	59.94(29.97)	15.7
576i	720x576 (1440x576)	50(25)	15.6
480p	720x480	59.94	31.5
576p	720x576	50	31.3
720p	1280x720	60	45.0
	1280x720	50	37.5
1080i	1920x1080	60(30)	33.8
	1920x1080	50(25)	28.1
1080p	1920x1080	23.98/24	27.0
	1920x1080	60	67.5
	1920x1080	50	56.3
d. HDMI 1.4a mandatory 3D timing- Video Signal			
Modes	Resolution	V. Frequency [Hz]	H. Frequency [Hz]
Frame Packing	720p	50	31.5
	720p	59.94/60	15.7
	1080p	23.98/24	15.6
Side-by-Side(Half)	1080i	50	31.5
	1080i	59.94/60	31.3
Top and Bottom	720p	50	45.0
	720p	59.94/60	37.5
	1080p	23.98/24	33.8



## RS232 Protocol Function List



1. There is a <CR> after all ASCII commands.
2. 0D is the HEX code for <CR> in ASCII code.

Baud Rate: 19200

Data Bits: 8

Parity: None

Stop Bits: 1

Flow Control : None

UART16550 FIFO: Disable

Projector Return (Pass): P

Projector Return (Fail): F

XX=00-99, projector's ID,  
XX=00 is for all projectors

### SEND to projector

232 ASCII Code	HX3070U Code	Function	Description
~XX00 1	7E 30 30 30 30 20 31 0D	Power ON	
~XX00 0	7E 30 30 30 30 20 30 0D	Power OFF	
~XX01 1	7E 30 30 30 31 20 31 0D	Resync	
~XX02 1	7E 30 30 30 32 20 31 0D	AV Mute(Blank)	On
~XX02 0	7E 30 30 30 32 20 30 0D		Off
~XX03 1	7E 30 30 30 33 20 31 0D	Mute	On
~XX03 0	7E 30 30 30 33 20 30 0D		Off
~XX04 1	7E 30 30 30 34 20 31 0D	Freeze	
~XX04 0	7E 30 30 30 34 20 30 0D	Unfreeze	
~XX05 1	7E 30 30 30 35 20 31 0D	Zoom Plus	
~XX06 1	7E 30 30 30 36 20 31 0D	Zoom Minus	
~XX12 1	7E 30 30 31 32 20 31 0D	Direct Source	HDMI 1
~XX12 5	7E 30 30 31 32 20 35 0D		VGA 1
~XX12 6	7E 30 30 31 32 20 36 0D		VGA 2
~XX12 10	7E 30 30 31 32 20 31 30 0D		Video
~XX12 11	7E 30 30 31 32 20 31 31 0D		Multimedia
~XX12 15	7E 30 30 31 32 20 31 35 0D		HDMI 2
~XX20 1	7E 30 30 32 30 20 31 0D	Color Mode	Bright
~XX20 2	7E 30 30 32 30 20 32 0D		PC
~XX20 3	7E 30 30 32 30 20 33 0D		Movie
~XX20 4	7E 30 30 32 30 20 34 0D		Game
~XX20 5	7E 30 30 32 30 20 35 0D		User
~XX21 n	7E 30 30 32 31 20 a 0D	Brightness	n = 0 (a=30) ~ 100 (a=31 30 30)
~XX22 n	7E 30 30 32 32 20 a 0D	Contrast	n = 0 (a=30) ~ 100 (a=31 30 30)
~XX23 n	7E 30 30 32 32 20 a 0D	Sharpness	n = 0 (a=30) ~ 31 (a=33 31)
~XX60 1	7E 30 30 36 30 20 31 0D	Format(aspect ratio)	4:3
~XX60 2	7E 30 30 36 30 20 32 0D		16:9
~XX60 3	7E 30 30 36 30 20 33 0D		16:10/Ultra Wide
~XX60 7	7E 30 30 36 30 20 37 0D		AUTO
~XX66 n	7E 30 30 36 36 20 a 0D	Keystone	n = -40/40
~XX70 1	7E 30 30 37 30 20 31 0D	Language	English
~XX70 2	7E 30 30 37 30 20 32 0D		German
~XX70 3	7E 30 30 37 30 20 33 0D		French
~XX70 4	7E 30 30 37 30 20 34 0D		Italian
~XX70 5	7E 30 30 37 30 20 35 0D		Spanish
~XX70 6	7E 30 30 37 30 20 36 0D		Portuguese
~XX70 7	7E 30 30 37 30 20 37 0D		Polish
~XX70 8	7E 30 30 37 30 20 38 0D		Dutch
~XX70 9	7E 30 30 37 30 20 39 0D		Swedish
~XX70 10	7E 30 30 37 30 20 31 30 0D		Norwegian

# Appendices

~XX70 22	7E 30 30 37 30 20 32 32 0D		Turkish
~XX70 24	7E 30 30 37 30 20 32 34 0D		Danish
~XX71 1	7E 30 30 37 31 20 31 0D	Projection(ceiling M)	Front-Desktop
~XX71 2	7E 30 30 37 31 20 32 0D		Rear-Desktop
~XX71 3	7E 30 30 37 31 20 33 0D		Front-Ceiling
~XX71 4	7E 30 30 37 31 20 34 0D		Rear-Ceiling
~XX72 1	7E 30 30 37 32 20 31 0D	Menu Location	Top Left
~XX72 2	7E 30 30 37 32 20 32 0D		Top Right
~XX72 3	7E 30 30 37 32 20 33 0D		Centre
~XX72 4	7E 30 30 37 32 20 34 0D		Bottom Left
~XX72 5	7E 30 30 37 32 20 35 0D		Bottom Right
~XX80 n	7E 30 30 38 30 20 a 0D	Mute	n = 1/0 (On/Off)
~XX81 n	7E 30 30 38 31 20 a 0D	Volume	n = 0 (a=30) ~ 30 (a=33 30)
~XX101 n	7E 30 30 31 30 31 20 a 0D	High Altitude	n = 0/1 (a=30/31)
~XX106 n	7E 30 30 31 30 36 20 a 0D	Auto Power Off (min)	n = 0 (a=30) ~ 120 (a=31 32 30) , step=5
~XX318 n	7E 30 30 33 31 38 20 a 0D	Microphone Volume	n = 0 (a=30) ~ 30 (a=33 30)
~XX112 1	7E 30 30 31 31 32 20 31 0D	Reset	Yes
~XX140 10	7E 30 30 31 34 30 20 31 30 0D		Up
~XX140 11	7E 30 30 31 34 30 20 31 31 0D		Left
~XX140 13	7E 30 30 31 34 30 20 31 33 0D		Right
~XX140 14	7E 30 30 31 34 30 20 31 34 0D		Down
~XX140 15	7E 30 30 31 34 30 20 31 35 0D		Keystone+
~XX140 16	7E 30 30 31 34 30 20 31 36 0D		Keystone-
~XX140 17	7E 30 30 31 34 30 20 31 37 0D		Volume-
~XX140 18	7E 30 30 31 34 30 20 31 38 0D		Volume+
~XX140 20	7E 30 30 31 34 30 20 32 30 0D		Menu
~XX140 29	7E 30 30 31 34 30 20 32 39 0D		Source

## READ from projector

232 ASCII Code	HX3070U Code	Function	Projector Return	Description
~XX121 1	7E 30 30 31 32 31 20 31 0D	Input Source(curr. src)	OKn	n : 0/2/3/5/7/8/10 = None / VGA1 / VGA2 / Video / HDMI1 / HDMI2 / Multimedia
~XX122 1	7E 30 30 31 32 32 20 31 0D	Software Version	OKdddd	dddd: FW version
~XX123 1	7E 30 30 31 32 33 20 31 0D	Display Mode	OKn	n: 1/2/3/4/5 = Bright/PC/Movie/Game/User
~XX127 1	7E 30 30 31 32 37 20 31 0D	Aspect Ratio	OKn	n: 1/2/3/7 = 4:3 / 16:9 / 16:10 / AUTO
~XX150 1	7E 30 30 31 35 30 20 31 0D	Information	Okabbbbbbccdddee	Make reference to below description,

a : Power Status, 1/Power On , 0/Standby

b : LD Hours, up to 99999 hours

c : Input Source, 0/2/3/5/7/8/9 = None / VGA1 / VGA2 / Video / HDMI1 / HDMI2 / Multimedia

d : Firmware Version, Power ON State : Scalar F/W version , Power OFF State : MCU version

e : Color Mode, 1/2/3/4/5 = Bright / PC / Movie / Game / User

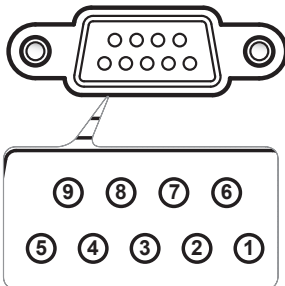

Pin no.	Spec. (from projector side)
1	N/A
2	TXD
3	RXD
4	N/A
5	GND
6	N/A
7	N/A
8	N/A
9	N/A

## Regulation & Safety Notices

*This appendix lists the general notices of your projector.*

### **FCC notice**

This device has been tested and found to comply with the limits for a Class B digital device pursuant to Part 15 of the FCC rules. These limits are designed to provide reasonable protection against harmful interference in a residential installation. This device generates, uses and can radiate radio frequency energy and, if not installed and used in accordance with the instructions, may cause harmful interference to radio communications.

However, there is no guarantee that interference will not occur in a particular installation. If this device does cause harmful interference to radio or television reception, which can be determined by turning the device off and on, the user is encouraged to try to correct the interference by one or more of the following measures:

- Reorient or relocate the receiving antenna.
- Increase the separation between the device and receiver.
- Connect the device into an outlet on a circuit different from that to which the receiver is connected.
- Consult the dealer or an experienced radio/television technician for help.

### **Notice: Shielded cables**

All connections to other computing devices must be made using shielded cables to maintain compliance with FCC regulations.

### **Caution**

Changes or modifications not expressly approved by the manufacturer could void the user's authority, which is granted by the Federal Communications Commission, to operate this projector.

# Appendices

## **Operation conditions**

This device complies with Part 15 of the FCC Rules. Operation is subject to the following two conditions:

1. This device may not cause harmful interference and
2. This device must accept any interference received, including interference that may cause undesired operation.

## **Notice: Canadian users**

This Class B digital apparatus complies with Canadian ICES-003.

## **Remarque à l'intention des utilisateurs canadiens**

Cet appareil numérique de la classe B est conforme à la norme NMB-003 du Canada.

## **Declaration of Conformity for EU countries**

- EMC Directive 2004/108/EC (including amendments)
- Low Voltage Directive 2006/95/EC
- R & TTE Directive 1999/5/EC (if product has RF function)

### **Disposal instructions**



**Do not throw this electronic device into the trash when discarding. To minimize pollution and ensure utmost protection of the global environment, please recycle it.**

## Safety notice

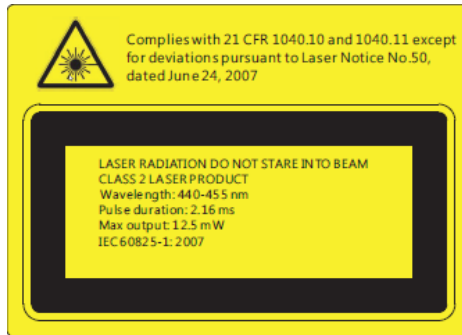

## WARNING

- This projector is a Class 2 laser device that conforms with IEC 60825-1:2007 and CFR 1040.10 and 1040.11.
- Class 2 laser product, Do Not Stare Into Beam.
- This projector has built-in Class 4 laser module. Disassembly or modification is very dangerous and should never be attempted.
- Any operation or adjustment not specifically instructed by the user's guide creates the risk of hazardous laser radiation exposure.
- Do not open or disassemble the projector as this may cause damage by the exposure of laser radiation.
- Do not stare into beam when the projector is on. The bright light may result in permanent eye damage.
- Without following the control, adjustment or operation procedure may cause damage by the exposure of laser radiation.
- Adequate instructions for assembly, operation, and maintenance, including clear warnings concerning precautions to avoid possible exposure to laser and collateral radiation in excess of the accessible emission limits in Class 2.

## Ceiling Mount Installation

1. To prevent damage to your projector, please use the Optoma ceiling mount.
2. If you wish to use a third party ceiling mount kit, please ensure the screws used to attach a mount to the projector meet the following specifications:

- ▶ Screw type: M4\*3
- ▶ Minimum screw length: 10mm



❖ Please note that damage resulting from incorrect installation will void the warranty.



### ⚠ Warning:

1. If you buy a ceiling mount from another company, please be sure to use the correct screw size. Screw size will vary depending on the thickness of the mounting plate.
2. Be sure to keep at least 10 cm gap between the ceiling and the bottom of the projector.
3. Avoid installing the projector near a heat source.

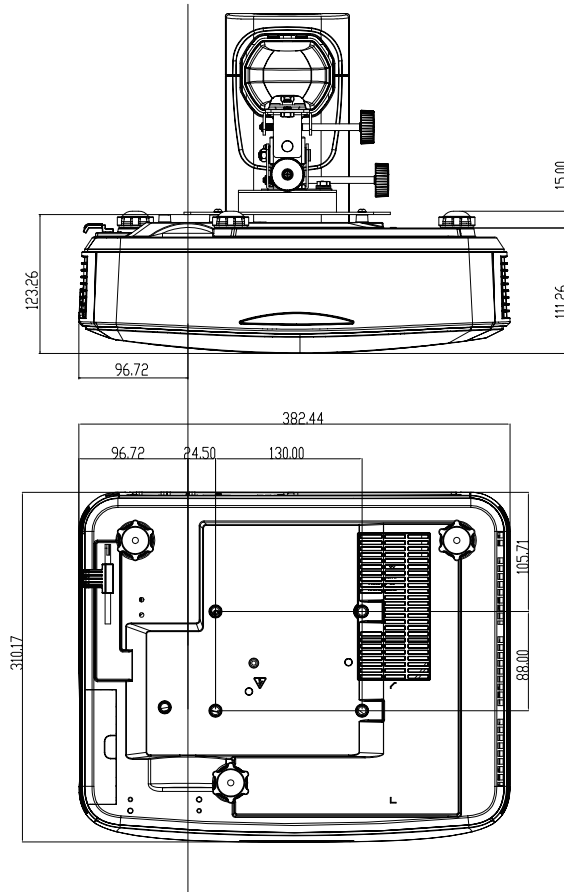



## Optoma global offices

For service or support, please contact your local office.



### USA

3178 Laurelview Ct.  
Fremont, CA 94538, USA  
[www.optomausa.com](http://www.optomausa.com)

 888-289-6786  
 510-897-8601  
 [services@optoma.com](mailto:services@optoma.com)



### Canada

3178 Laurelview Ct.  
Fremont, CA 94538, USA  
[www.optomausa.com](http://www.optomausa.com)

 888-289-6786  
 510-897-8601  
 [services@optoma.com](mailto:services@optoma.com)

### Latin America

3178 Laurelview Ct.  
Fremont, CA 94538, USA  
[www.optomausa.com](http://www.optomausa.com)

 888-289-6786  
 510-897-8601  
 [services@optoma.com](mailto:services@optoma.com)



### Europe

42 Caxton Way, The Watford Business Park  
Watford, Hertfordshire,  
WD18 8QZ, UK  
[www.optoma.eu](http://www.optoma.eu)  
Service Tel : +44 (0)1923 691865

 +44 (0) 1923 691 800  
 +44 (0) 1923 691 888  
 [service@tsc-europe.com](mailto:service@tsc-europe.com)

### Benelux BV

Randstad 22-123  
1316 BW Almere  
The Netherlands  
[www.optoma.nl](http://www.optoma.nl)

 +31 (0) 36 820 0253  
 +31 (0) 36 548 9052

### France

Bâtiment E  
81-83 avenue Edouard Vaillant  
92100 Boulogne Billancourt,  
France

 +33 1 41 46 12 20  
 +33 1 41 46 94 35  
 [savoptoma@optoma.fr](mailto:savoptoma@optoma.fr)



### Spain

C/ José Hierro,36 Of. 1C  
28522 Rivas VaciaMadrid,  
Spain

 +34 91 499 06 06  
 +34 91 670 08 32



### Deutschland

Wiesenstrasse 21 W  
D40549 Düsseldorf,  
Germany

 +49 (0) 211 506 6670  
 +49 (0) 211 506 66799  
 [info@optoma.de](mailto:info@optoma.de)

### Scandinavia



Lerpeveien 25  
3040 Drammen  
Norway

 +47 32 98 89 90  
 +47 32 98 89 99  
 [info@optoma.no](mailto:info@optoma.no)

PO.BOX 9515  
3038 Drammen  
Norway

### Korea

WOOMI TECH.CO.,LTD.  
4F,Minu Bldg.33-14, Kangnam-Ku,  
seoul,135-815, KOREA

 +82+2+34430004  
 +82+2+34430005

### Japan

東京都足立区綾瀬3-25-18



株式会社オーエス

コンタクトセンター:0120-380-495

 [info@os-worldwide.com](mailto:info@os-worldwide.com)  
[www.os-worldwide.com](http://www.os-worldwide.com)



### Taiwan

12F., No.215,Sec. 3, Beixin Rd.,  
Xindian Dist., New Taipei City 231,  
Taiwan, R.O.C.  
[www.optoma.com.tw](http://www.optoma.com.tw)

 +886-2-8911-8600  
 +886-2-8911-6550  
 [services@optoma.com.tw](mailto:services@optoma.com.tw)  
[asia.optoma.com](http://asia.optoma.com)



### Hong Kong

Unit A, 27/F Dragon Centre,  
79 Wing Hong Street,  
Cheung Sha Wan,  
Kowloon, Hong Kong

 +852-2396-8968  
 +852-2370-1222  
[www.optoma.com.hk](http://www.optoma.com.hk)

### China

5F, No. 1205, Kaixuan Rd.,  
Changning District  
Shanghai, 200052, China

 +86-21-62947376  
 +86-21-62947375  
[www.optoma.com.cn](http://www.optoma.com.cn)