



Scan for full manual

VP-440H2 Quick Start Guide

This guide helps you install and use your **VP-440H2** for the first time.

Go to www.kramerav.com/downloads/VP-440H2 to download the latest user manual and check if firmware upgrades are available.

Step 1: Check what's in the box

- ✓ **VP-440H2** 4K Presentation Switcher Scaler
- ✓ 1 Power cord
- ✓ 1 Bracket set
- ✓ 1 Power supply (48V DC)
- ✓ 1 Quick start guide
- ✓ 4 Rubber feet

Step 2: Get to know your VP-440H2

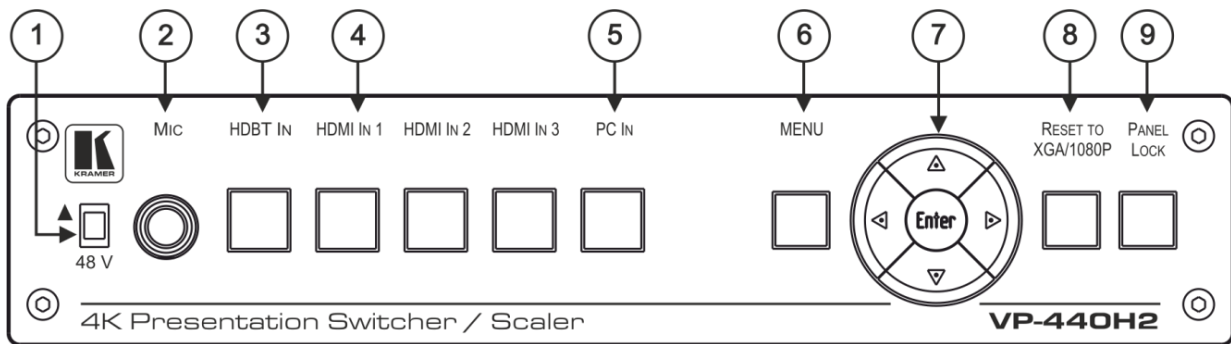

#	Feature	Function
1	48 V (▲) Slide Switch	Slide up (48V) to select a condenser type microphone; slide down to select a dynamic type microphone (we recommend that you slide down if a microphone is not connected to the VP-440H2).
2	MIC 6.3mm Jack	Connect to the microphone source.
3	Input Selector Buttons	HDBT IN Press to select the HDBT input.
4		HDMI IN Press to select the HDMI input (from 1 to 3).
5		PC IN Press to select the computer graphics input.
6	MENU Button	Displays the OSD menu.
7	Navigation Buttons	◀ Press to decrease numerical values or select from several definitions. When not in the OSD menu, press to reduce the output volume.
		▲ Press to move up the menu list values.
		▶ Press to increase numerical values or select from several definitions. When not in the OSD menu, press to increase the output volume.
		▼ Press to move down the menu list.
		ENTER Press to accept changes and change the SETUP parameters.
8	RESET TO XGA/1080p Button	Press and hold for about 5 seconds to toggle the output resolution between XGA and 1080p, alternatively.
9	PANEL LOCK Button	Press and hold for about 5 seconds to lock/unlock the front panel buttons.



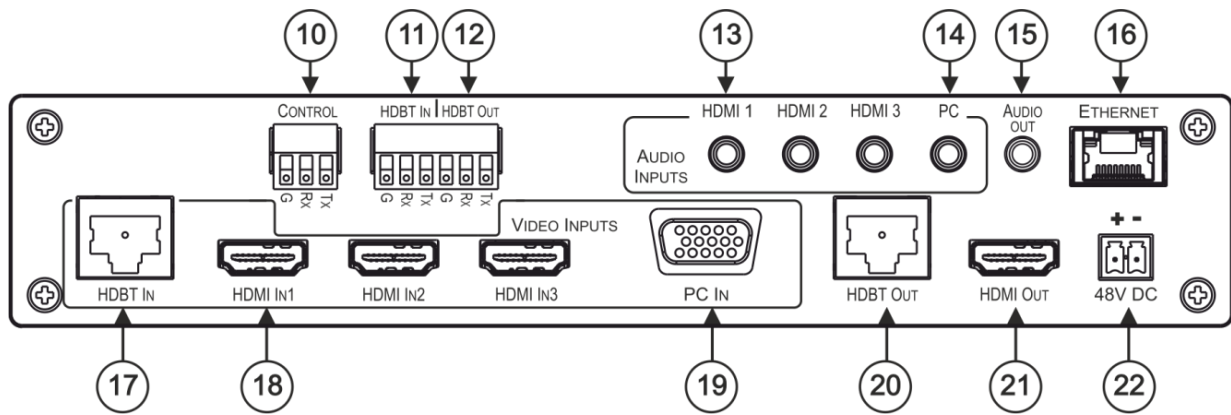

#	Feature	Function	
10	CONTROL (Tx, Rx, GND) Terminal Block Connectors	Connect to the PC or the serial controller to control the device.	
11	HDBT IN (Tx, Rx, GND) Terminal Block Connectors	Connect to a controller to control peripheral devices that are connected to the HDBT transmitter (for example, a Blu-ray player connected to WP-20).	
12	HDBT OUT (Tx, Rx, GND) Terminal Block Connectors	Connect to a controller to control peripheral devices that are connected to the HDBT receiver (for example, a projector connected to TP-580Rxr).	
13	AUDIO INPUT	HDMI	Connect to the analog audio HDMI source (from 1 to 3).
14	Unbalanced Stereo 3.5 Mini Jack	PC	Connect to the analog audio computer graphics source.
15	AUDIO OUT 3.5 Mini Jack		Connect to an unbalanced stereo audio acceptor.
16	ETHERNET Connector		Connects to the PC or other controller through computer networking.
17	VIDEO INPUT Connectors	HDBT IN RJ-45	Connect to an HDBT transmitter (for example, WP-20). Can supply PoE (up to 13W) to the transmitter.
18		HDMI IN	Connect to the HDMI source (from 1 to 3).
19		PC IN on 15-pin HD	Connect to the computer graphics source.
20	HDBT OUT RJ-45 Connector		Connect to an HDBT receiver (for example, TP-580Rxr).
21	HDMI OUT Connector		Connect to the HDMI acceptor.
22	48V DC Power Terminal Block		+48V DC connector for powering the unit.

Step 3: Install VP-440H2

To mount the **VP-440H2** in a rack, use an **RK-1** rack adapter. Alternatively, attach the rubber feet to the underside of the **VP-440H2** and place it on a table.

Step 4: Connect the inputs and outputs

Always switch OFF the power on each device before connecting it to your **VP-440H2**. For best results, we recommend that you always use Kramer high-performance cables to connect AV equipment to **VP-440H2**.

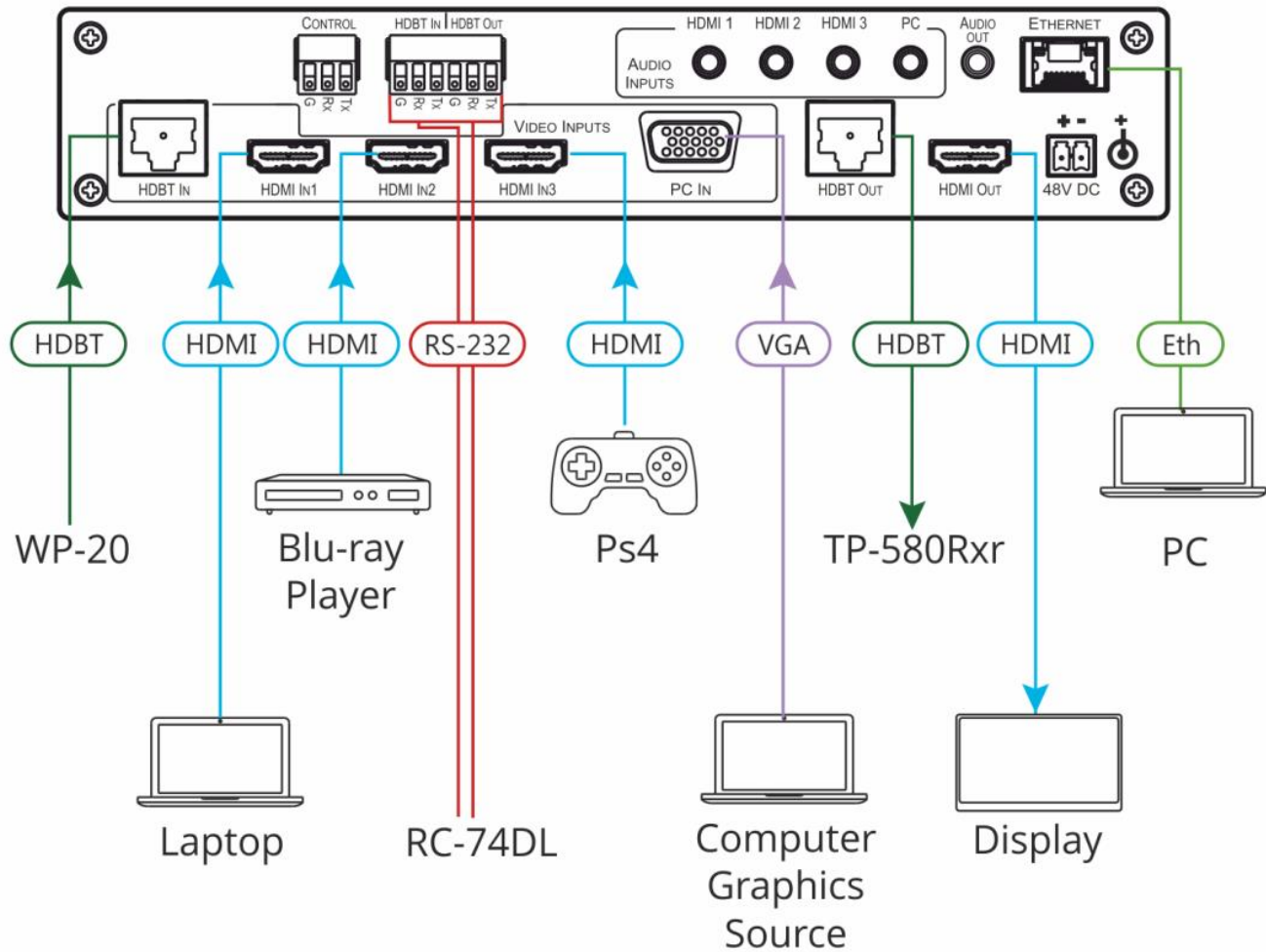

RJ-45 Pinout:

For the Ethernet connector, see the wiring diagram below

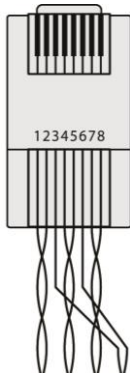

PIN EIA /TIA 568B	
PIN	Wire Color
1	Orange / White
2	Orange
3	Green / White
4	Blue
5	Blue / White
6	Green
7	Brown / White
8	Brown

Microphone Pinout:

The microphone 6mm jack pinout for a condenser microphone

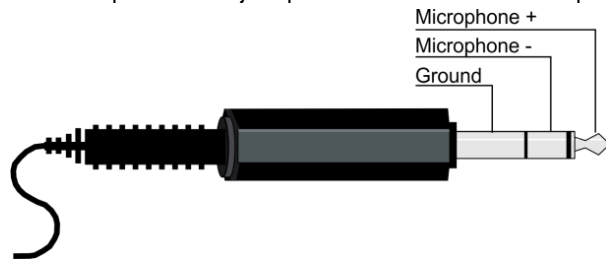

The microphone 6mm jack pinout for a dynamic microphone.

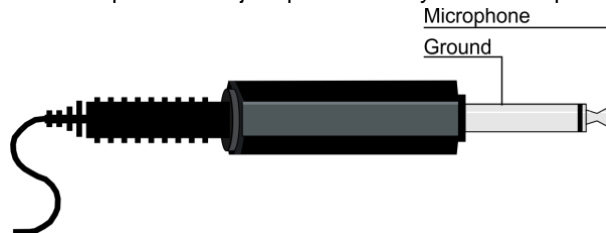

For optimum range and performance use the recommended Kramer cables available at www.kramerav.com/product/VP-440H2.

Step 5: Connect the power

Connect the 48V DC power adapter power cord to **VP-440H2** and plug it into the mains electricity.

Safety Instructions (DC)



Caution: There are no operator serviceable parts inside the unit.

Warning: Use only the Kramer Electronics power supply that is provided with the unit.

Warning: Disconnect the power and unplug the unit from the wall before installing.

See www.KramerAV.com for updated safety information.

Step 6: Control and operate VP-440H2 via the front panel buttons and via

Web pages:

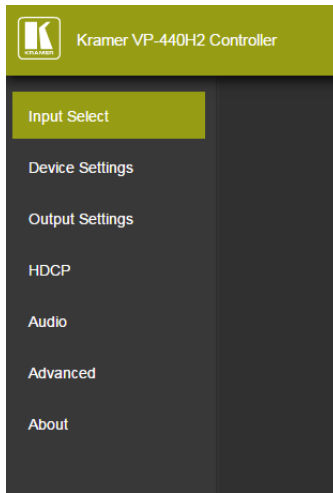

OSD Menu:

Menu	Menu Items
Picture	Adjust contrast brightness and color, and fine-tune the image.
Input	Select input source.
Output	Select method for 4K input to 4K output handling, image size and resolution.
Audio	Select audio source, audio parameters (bass, treble and so on), microphone settings and volume per input.
OSD	Set OSD position, transparency and so on.
Advanced	Select HDCP on each of the inputs and outputs, manage the EDID and define IP settings.
Info.	View device information.
Factory	Reset to factory default settings.