

KRAMER



USER MANUAL

MODELS:

VCO-1, VCO-8, VCO-16

Video Content Overlay Solution



VCO-1, VCO-8, VCO-16 Quick Start Guide

This guide helps you install and use your product for the first time. For more detailed information, go to <http://www.kramerav.com/manual/VCOs> to download the latest manual (or scan the QR code) and check if firmware upgrades are available.

Step 1: Check what's in the box

- ✓ VCO-1, VCO-8 or VCO-16 Video Content Overlay
- ✓ 1 Set of rack ears (VCO-8/VCO-16)
- ✓ Cable bracket (for VCO-8/VCO-16)
- ✓ 1 Power cord (VCO-8/VCO-16)
- ✓ 4 Rubber feet
- ✓ 1 Quick start guide
- ✓ 1 Power adapter (VCO-1)

Step 2: Install the device

VCO-8 / VCO-16: To rack mount the device attach both ear brackets to the device (by removing the three screws from each side of the device and replacing those screws through the ear brackets) or place the device on a table.

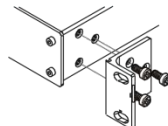

VCO-1: To mount the VCO-1 in a rack, use an RK-3T rack adapter. Alternatively, attach the rubber feet to the underside of the VCO-1 and place it on a table.

A Kramer TOOLS™ can also be mounted on a desk top, wall or similar area. Fasten a bracket on each side of the TOOLS using the two M3x8 screws (supplied). Use the flat-head screws (supplied) to fix the TOOLS to the mounting surface or enable it to slide in place.

Step 3: Connect inputs and outputs

Always switch OFF the power of your AV equipment and VCO-1 / VCO-8 / VCO-16 device before connecting any inputs or outputs. For best results, we recommend that you always use Kramer high-performance cables to connect AV equipment to the VCO-1 / VCO-8 / VCO-16 device.

VCO-8 / VCO-16:

Note that VCO-8 is identical to VCO-16 except for the number of outputs:8 for VCO-8 and 16 for VCO-16.

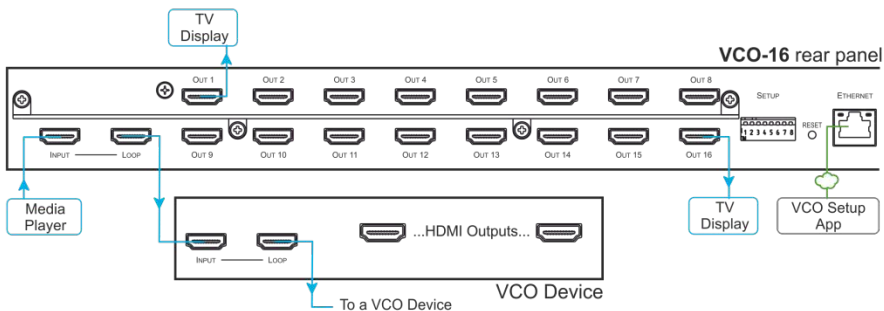

192.168.1.39 is the default IP address for all VCO devices.

Step 3: Connect inputs and outputs (continued)

VCO-1:

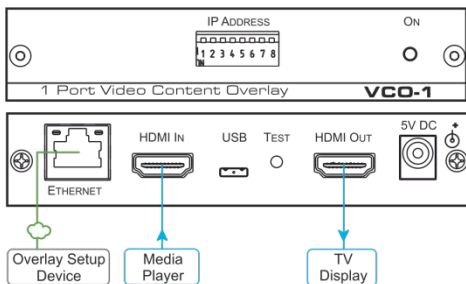

192.168.1.39 is the default IP address for all VCO devices.

Step 4: Connect the power

VCO-8 / VCO-16: Connect AC power to the rear of the device, switch ON its power and then switch ON the power of your AV equipment.

VCO-1: Connect the 5V DC power adapter to the VCO-1, plug the adapter into the mains electricity and then switch ON the power of your AV equipment.

Step 5: Setup the overlay application

Use the Kramer VCO Setup application to manage the VCO-1 / VCO-8 / VCO-16 device, define separate content layers for each output, and send the overlays to the VCO-1 / VCO-8 / VCO-16 device (via LAN).

You can download the KramerVCO-Setup.exe file from our Web site at: <http://www.kramerav.com/downloads/VCOs>.

TV Showroom example (also applies to coffee shops, sports bars, public areas and so on)



Contents

1	Introduction	1
2	Getting Started	2
2.1	Achieving the Best Performance	2
2.2	Safety Instructions	3
2.3	Recycling Kramer Products	3
3	Overview	4
3.1	Defining the Video Content Overlay Solution	6
4	Installing the VCO-8 and VCO-16 in a Rack	9
5	Connecting the VCO-1, VCO-8, VCO-16	10
5.1	Connecting the VCO-8 / VCO-16	10
5.2	Connecting the VCO-1	12
6	Looping the VCO-8 and VCO-16	13
7	Using the Kramer VCO Setup Application	15
7.1	Install the VCO Setup Application	15
7.2	Setup & About	19
7.3	Setting the Overlays	32
7.4	Scheduling the Overlays	56
8	Defining an IP Address for a Device	66
8.1	Setting a Static IP Address	66
8.2	Operating via the Ethernet	70
9	Technical Specifications	75
9.1	Default Communication Parameters	76
10	Communication Protocol	77
10.1	Understanding Protocol 3000	78
10.2	Kramer Protocol 3000 Syntax	80
10.3	Protocol 3000 Commands	81

Figures

Figure 1: VCO-1 Front and Rear Panels	6
Figure 2: VCO-8 and VCO-16 Front Panels	7
Figure 3: VCO-8 and VCO-16 Rear Panels	8
Figure 4: Connecting the VCO-8 / VCO-16	11
Figure 5: Connecting the VCO-1	12
Figure 6: A Set of 2 Looped VCO-16 Units	14
Figure 7: Installing the VCO Setup App - Warning	16
Figure 8: Installing the VCO Setup App – Setup Application Description	16
Figure 9: Installing the VCO Setup App – Legal info	16
Figure 10: Installing the VCO Setup App – Setting the Destination Folder	17
Figure 11: Installing the VCO Setup App– Installing the Software	17
Figure 12: Installing the VCO Setup App – Installation is Complete	17
Figure 13: Installing the VCO Setup App – The Setup & About Tab	18
Figure 14: Setup & About Tab	19
Figure 15: Setup & About – Selecting the Language	19
Figure 16: Welcome to Device Wizard	20
Figure 17: Device Wizard	21
Figure 18: Device Wizard – Add Device Manually	22

Figure 19: Device Wizard – Selecting a Device	22
Figure 20: Device Wizard – Device Selected	23
Figure 21: Device Wizard – Setting the IP Address	23
Figure 22: Device Wizard – Setting the Lower Number of the IP address.	24
Figure 23: Device Wizard – Setting the Higher parts of the IP Address	25
Figure 24: Device Wizard – Changing the IP Address	25
Figure 25: Device Wizard – Changing the Higher Parts of the IP Address	26
Figure 26: Changing the IP Address Message	26
Figure 27: Device Wizard – Changing the IP Address Higher Parts	27
Figure 28: Device Wizard – Testing the IP Address Change	27
Figure 29: Device Wizard Setting the Recommended Name	28
Figure 30: Device Wizard – Set the Device Name	28
Figure 31: Device Wizard – Device Installed	29
Figure 32: Device Wizard –Device Details	29
Figure 33: Device Wizard – Automatic IP Address Detection	30
Figure 34: Device Wizard – Searching for an IP Address	30
Figure 35: Device Wizard – Device IP Address Detected	31
Figure 36: Device Wizard –The Device Details (following Automatic Scan)	31
Figure 37: Setting the Overlays – Right-Clicking the All Overlays folder	32
Figure 38: Setting the Overlays – the Overlay Tab	33
Figure 39: Setting the Overlays – Create a New Folder	33
Figure 40: Setting the Overlays – New Folder Added	34
Figure 41: Setting the Overlays – the Overlay Tab	34
Figure 42: Setting the Overlays – the Add New Overlay Window	35
Figure 43: Setting the Overlays – Add a New Name and Description	35
Figure 44: Setting the Overlays – The Overlay Added to the Overlay List	36
Figure 45: Setting the Overlays – Template Details	36
Figure 46: Setting the Overlays – Bind Overlay to Machine	37
Figure 47: Setting the Overlays – the Overlay Settings	38
Figure 48: Setting the Overlays – Building Overlay Message	38
Figure 49: Setting the Overlays – Rendering the Overlay	39
Figure 50: Setting the Overlays – View of the Overlay	39
Figure 51: Adding a New/External Template – Launching the Template Wizard	40
Figure 52: Adding a New/External Template – Template Wizard	40
Figure 53: Adding a New/External Template – Available File Operations	41
Figure 54: Adding a New/External Template – Available Folder Operations	41
Figure 55: Adding a New/External Template – Ready-to-Use Template – External Source	42
Figure 56: Adding a New/External Template – Selecting the Folder	42
Figure 57: Adding a New/External Template – Selecting the Template	43
Figure 58: Adding a New/External Template – Available Operations	43
Figure 59: Adding a New/External Template – New Template Added	44
Figure 60: Creating a New Overlay	44
Figure 61: Template Wizard – Setting the Resolution	45
Figure 62: Template Wizard – Adding and Editing Window	45
Figure 63: Template Wizard – Editing the PNG graphic	47
Figure 64: Template Wizard – Resizing Options	48
Figure 65: Template Wizard – Adding Graphics	48
Figure 66: Template Wizard – Create Playback Program	49
Figure 67: Template Wizard – Add Template Description and see Preview	50
Figure 68: New Template Added	51
Figure 69: Setting the Movement and Transparency – the Program Editor	52
Figure 70: Scheduling Tab	57
Figure 71: Scheduling – Adding an Event	58
Figure 72: Scheduling – Adding Overlays to the Event	59

Figure 73: Scheduling – Firing an Event	60
Figure 74: Scheduling – Enable Scheduling	61
Figure 75: Setting the IP Address	66
Figure 76: Setting the High Parts of the IP Address	69
Figure 77: DHCP Mode DIP-Switch Setup	70
Figure 78: Local Area Connection Properties Window	72
Figure 79: Internet Protocol Version 4 Properties Window	72
Figure 80: Internet Protocol Version 6 Properties Window	73
Figure 81: Internet Protocol Properties Window	74

1 Introduction

Welcome to Kramer Electronics! Since 1981, Kramer Electronics has been providing a world of unique, creative, and affordable solutions to the vast range of problems that confront video, audio, presentation, and broadcasting professionals on a daily basis. In recent years, we have redesigned and upgraded most of our line, making the best even better!

Our 1,000-plus different models now appear in 14 groups that are clearly defined by function: GROUP 1: Distribution Amplifiers; GROUP 2: Switchers and Routers; GROUP 3: Control Systems; GROUP 4: Format/Standards Converters; GROUP 5: Range Extenders and Repeaters; GROUP 6: Specialty AV Products; GROUP 7: Scan Converters and Scalers; GROUP 8: Cables and Connectors; GROUP 9: Room Connectivity; GROUP 10: Accessories and Rack Adapters; GROUP 11: Sierra Video Products; GROUP 12: Digital Signage; GROUP 13: Audio; and GROUP 14: Collaboration.

Congratulations on purchasing your Kramer **VCO-1**, **VCO-8**, **VCO-16** Video Content Overlay Solution. This product, which incorporates HDMI™ technology, is ideal for:

- Providing visitor information, messages, promotional ads, and emergency announcements overlaid on your current display network
- Hotel lobbies, lounges, guest rooms and conference rooms
- Sports bars, nightclubs, special venues
- Restaurants, cafes, diners

2 Getting Started

We recommend that you:

- Unpack the equipment carefully and save the original box and packaging materials for possible future shipment
- Review the contents of this user manual
- Use Kramer high performance high resolution cables



Go to www.kramerav.com/downloads/VCOs to check for up-to-date user manuals, application programs, and to check if firmware upgrades are available (where appropriate).

2.1 Achieving the Best Performance

To achieve the best performance:

- Use only good quality connection cables (we recommend Kramer high-performance, high-resolution cables) to avoid interference, deterioration in signal quality due to poor matching, and elevated noise levels (often associated with low quality cables)
- Do not secure the cables in tight bundles or roll the slack into tight coils
- Avoid interference from neighbouring electrical appliances that may adversely influence signal quality
- Position your Kramer **VCO-1**, **VCO-8**, **VCO-16** away from moisture, excessive sunlight and dust



This equipment is to be used only inside a building. It may only be connected to other equipment that is installed inside a building.

2.2 Safety Instructions



Caution: There are no operator serviceable parts inside the unit

Warning: Use only the power cord that is supplied with the unit

Warning: Do not open the unit. High voltages can cause electrical shock! Servicing by qualified personnel only

Warning: Disconnect the power and unplug the unit from the wall before installing

2.3 Recycling Kramer Products

The Waste Electrical and Electronic Equipment (WEEE) Directive 2002/96/EC aims to reduce the amount of WEEE sent for disposal to landfill or incineration by requiring it to be collected and recycled. To comply with the WEEE Directive, Kramer Electronics has made arrangements with the European Advanced Recycling Network (EARN) and will cover any costs of treatment, recycling and recovery of waste Kramer Electronics branded equipment on arrival at the EARN facility. For details of Kramer's recycling arrangements in your particular country go to our recycling pages at www.kramerav.com/support/recycling/.

3 Overview

Kramer **VCO** solutions let users display targeted messages across any number of displays in showrooms, bars, lobbies, or conference rooms. **VCO-1**, **VCO-8**, and **VCO-16** are specialized distribution amplifiers that can distribute independent content layers to 1, 5, 8, or 16 and optionally to any number of displays over standard HDMI in full HD resolution (1080p60 or 1920x1200).

Simply connect the Kramer **VCO** to each display with a single HDMI cable, choose any standard graphics file to be overlaid (such as a reminder that the bar will close at 11:00pm), and that's all. The **VCO** solution also enables scheduling specific messages to be overlaid on specific displays at any chosen time and provides a set of overlay templates for initial use.

With centralized control, Kramer **VCO** solutions let users manage individual video content overlays for each connected display from anywhere in the world.

With Kramer **VCO**, you get:

- Comprehensive Digital Overlay Solution:
 - Complete, project-tailored solution for all your display needs
 - Support for an unlimited number of overlays and displays
 - Individual or multi-channel control and centralized operation and management
 - Precise scheduling of each individual overlay per display
 - Static or animated dynamic color image overlays in full HD
 - Multiple overlay templates for multiple applications
 - Comprehensive error reporting for connected displays and overlays
- Flexible Integration and Usability:
 - Use with any customer management system
 - Use your existing display network infrastructure
 - Supports any-sized content overlays with full transparency control

- Built-in looping output for daisy chaining any number of devices (**VCO-8** and **VCO-16** only)
- Cost Effective. User-Friendly Operation and Management:
 - Easy setup with a non-technical, user-friendly and feature-rich interface
 - Automatically displays engaging static or animated messages and push notification campaigns, full-HD resolution to multiple displays in multiple zones over live video from cameras, satellite receivers, PCs, or media players — in a single click
 - Simple, cost-effective operation and management — from a single display in a bar to hundreds of displays in a hotel
 - Problem-free installation, instant error reporting for each display and an international warranty with localized support

VCO-8 and **VCO-16** are housed in a 19" 1U rack mountable enclosure with rack "ears". They use a 100-240 VAC universal switching power supply.

VCO-1 is housed in a compact TOOLS size. Three units can be rack-mounted side by side in a 1U rack space with an optional **RK-3T** rack adapter tool.

3.1 Defining the Video Content Overlay Solution

This section defines the **VCO-1**, **VCO-8** and **VCO-16**.

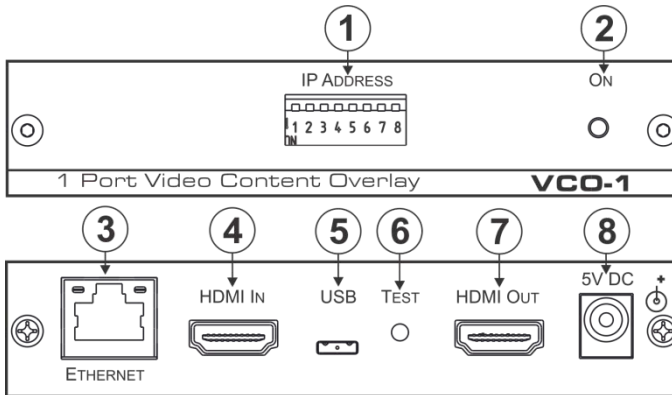

Figure 1: VCO-1 Front and Rear Panels

#	Feature	Function
1	IP ADDRESS DIP-Switches	For setting the last number in the machine LAN IPv4 address (see Section 8.1.1)
2	ON LED	Lights when an input signal is active; flashes slowly when no input signal is detected
3	ETHERNET Connector	Connect to the PC or other serial controller through computer networking
4	HDMI IN Connector	Connect to the source
5	Micro USB Port	Used to import graphic images
6	TEST Button	Press for 5 seconds to reset the IP address to its default value. Press briefly to enter the test pattern mode. The input signal is replaced with a test pattern at 1080p. Press briefly again to cycle between available test patterns or return to the input signal. Test pattern mode is useful for initial setup of the system
7	HDMI OUT Connector	Connect to the display
8	5V DC	+5V DC connector for powering the unit

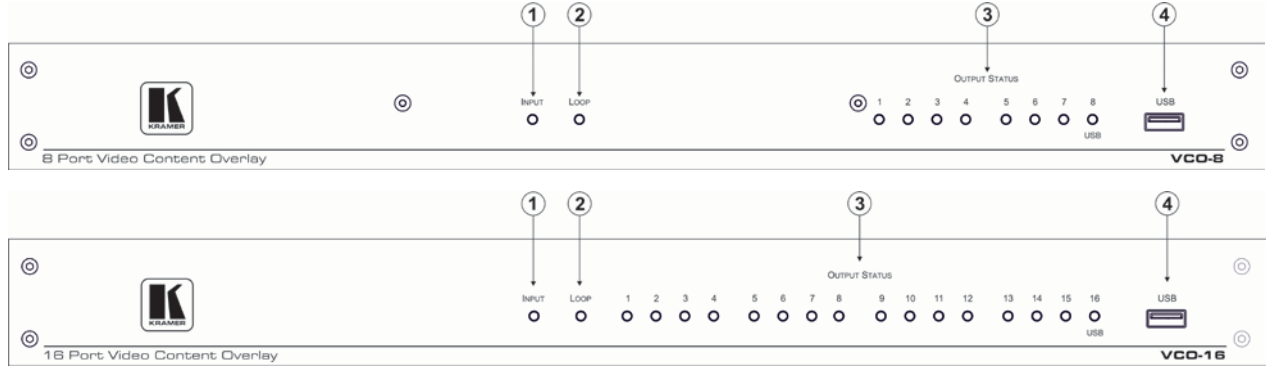

Figure 2: VCO-8 and VCO-16 Front Panels

#	Feature	Function
1	INPUT LED	Lights when an input signal is active; flashes slowly when no input signal is detected
2	LOOP LED	Lights on the looped device when a looped signal is in use
3	OUTPUT STATUS LEDS	Lights when an output signal is active
4	USB CONNECTOR	Used to import graphic images

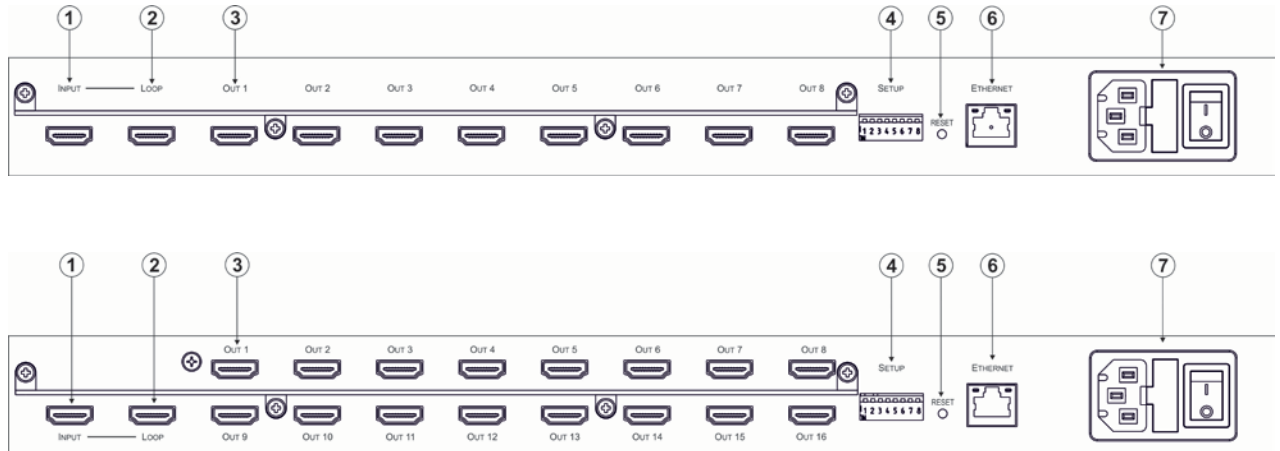

Figure 3: VCO-8 and VCO-16 Rear Panels

#	Feature	Function
1	INPUT HDMI Connector	Connect to the source
2	LOOP HDMI Connector	Connect to a machine to daisy chain additional displays
3	OUT HDMI Connector	Connect to the displays from 1 to 8 (VCO-8); from 1 to 16 (VCO-16)
4	SETUP DIP-Switches	For setting the Last number in the machine LAN IPv4 address (see Section 8.1.1)
5	RESET Button	Press for 5 seconds to reset the IP address to its default value. Press briefly to enter the test pattern mode. The input signal is replaced with a test pattern at 1080p. Press briefly again to cycle between available test patterns or return to the input signal. Test pattern mode is useful for initial setup of the system
6	ETHERNET Connector	Connects to the PC or other serial controller through computer networking
7	Power Connector with Fuse	AC connector, enabling power supply to the unit

4 Installing the VCO-8 and VCO-16 in a Rack

This section provides instructions for rack mounting the unit.

Before installing in a rack, be sure that the environment is within the recommended range:

OPERATING TEMPERATURE:	0° to +40°C (32° to 104°F)
STORAGE TEMPERATURE:	-40° to +70°C (-40° to 158°F)
HUMIDITY:	10% to 90%, RHL non-condensing



CAUTION!

When installing on a 19" rack, avoid hazards by taking care that:

1. It is located within the recommended environmental conditions, as the operating ambient temperature of a closed or multi unit rack assembly may exceed the room ambient temperature.
2. Once rack mounted, enough air will still flow around the machine.
3. The machine is placed straight in the correct horizontal position.
4. You do not overload the circuit(s). When connecting the machine to the supply circuit, overloading the circuits might have a detrimental effect on overcurrent protection and supply wiring. Refer to the appropriate nameplate ratings for information. For example, for fuse replacement, see the value printed on the product label.
5. The machine is earthed (grounded) in a reliable way and is connected only to an electricity socket with grounding. Pay particular attention to situations where electricity is supplied indirectly (when the power cord is not plugged directly into the socket in the wall), for example, when using an extension cable or a power strip, and that you use only the power cord that is supplied with the machine.

To rack-mount a machine:

1. Attach both ear brackets to the machine. To do so, remove the screws from each side of the machine (3 on each side), and replace those screws through the ear brackets.

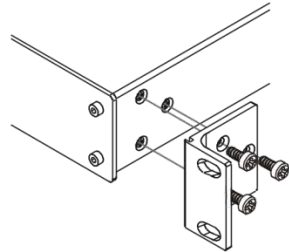

2. Place the ears of the machine against the rack rails, and insert the proper screws (not provided) through each of the four holes in the rack ears.

Note:

- In some models, the front panel may feature built-in rack ears
- Detachable rack ears can be removed for desktop use
- Always mount the machine in the rack before you attach any cables or connect the machine to the power
- If you are using a Kramer rack adapter kit (for a machine that is not 19"), see the Rack Adapters user manual for installation instructions available from our Web site

5 Connecting the VCO-1, VCO-8, VCO-16



Always switch off the power to each device before connecting it to your **VCO-1, VCO-8, VCO-16**.

After connecting your **VCO-1, VCO-8, VCO-16**, connect its power and then switch on the power to each device.



You do not have to connect all the outputs, connect only those that are required.

5.1 Connecting the VCO-8 / VCO-16

To connect the **VCO-8 / VCO-16**, as illustrated in the example in [Figure 4](#):

1. Connect an HDMI source (for example, a media player) to the HDMI INPUT connector.
Alternatively, you can connect the DVI connector on the DVD player to the HDMI connector on the **VCO-8 / VCO-16** via a DVI-HDMI adapter
2. If required, connect a looped HDMI acceptor (for example, from the HDMI LOOP connector to the INPUT of another **VCO** device), see [Section 6](#).
3. Connect the HDMI OUT connectors to HDMI acceptors (for example, LCD displays): 1 to 8 for **VCO-8**, 1 to 16 for **VCO-16**.
4. Connect the power cord (not shown in [Figure 4](#)).
5. Connect the ETHERNET port, see [Section 8.2](#).

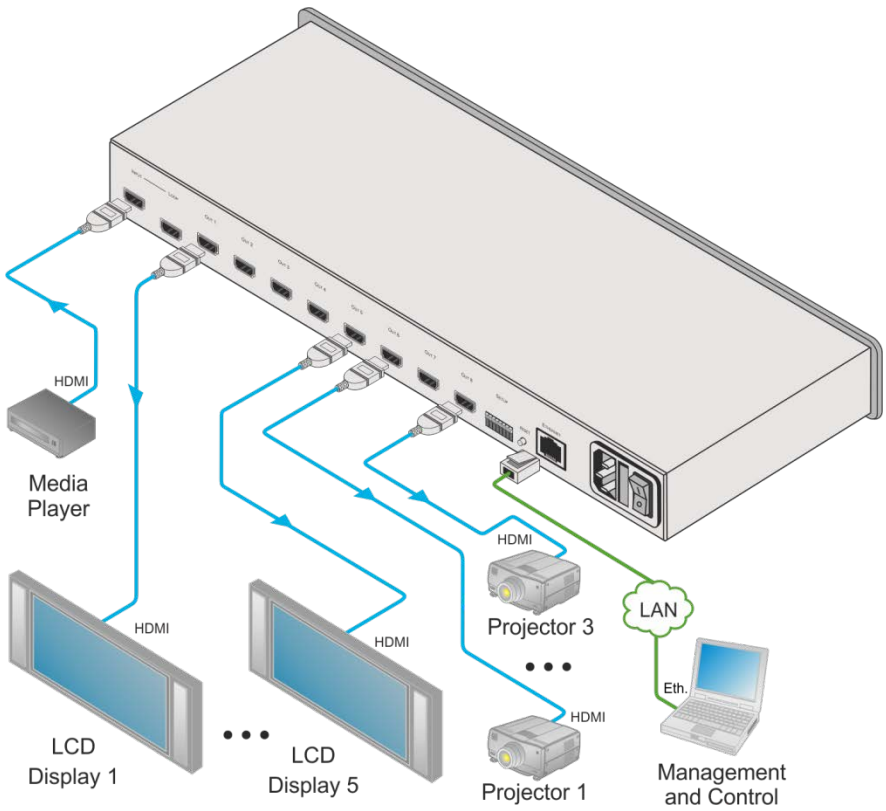

Figure 4: Connecting the VCO-8 / VCO-16

5.2 Connecting the VCO-1

To connect the VCO-1 as illustrated in the example in [Figure 5](#):

1. Connect an HDMI source (for example, a media player) to the HDMI IN connector.
Alternatively, you can connect the DVI connector on the DVD player to the HDMI connector on the **VCO-1** via a DVI-HDMI adapter.
2. Connect the HDMI OUT connector to an HDMI acceptor (for example, an LCD display).
3. Connect the 5V DC power adapter to the power socket and connect the adapter to the mains electricity (not shown in [Figure 5](#)).
4. Connect the ETHERNET port, see [Section 8.2](#).

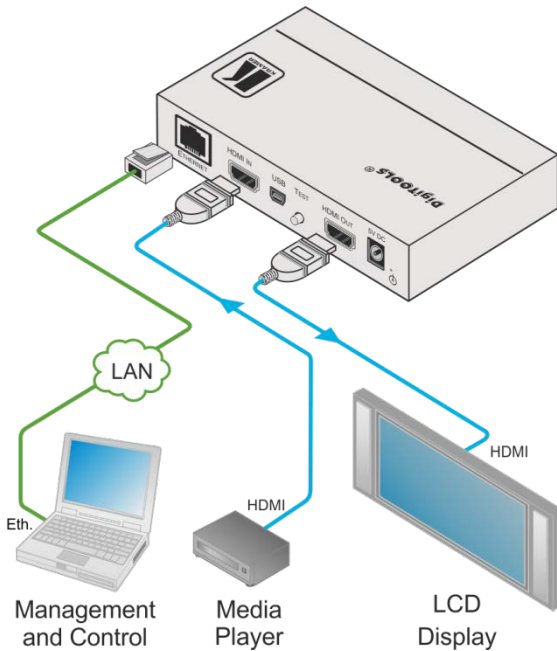

Figure 5: Connecting the VCO-1

6 Looping the VCO-8 and VCO-16

In the following example, two **VCO-16** devices are connected via the LOOP connector to produce a 32 port video overlay. One video input is distributed to 32 outputs with individual content overlay set to each of the 32 outputs.

To connect two looped **VCO-16** units with 32 outputs, as shown in the example in [Figure 6](#), do the following:

1. On the first **VCO-16** unit, connect:
 - A video source to the HDMI INPUT connector (for example, a Blu-ray player)
 - The OUT HDMI connectors to acceptors (for example, displays)
2. Connect the LOOP HDMI connector of the first unit to the INPUT HDMI Connector of the second unit.
3. On the second **VCO-16** unit, connect the OUT HDMI connectors to acceptors (for example, LCD displays)



In the Kramer **VCO** Setup App, each device in the daisy chain has a separate IP address and each of the 32 outputs is given a unique name and can be set with its own specific overlay.

In the same way you can loop an almost unlimited number of devices if HDCP is not in use and up to five devices when HDCP is in use.



When an HDCP source, such as a Blu-ray player or a SAT receiver, is used the number of looped devices may be lower.

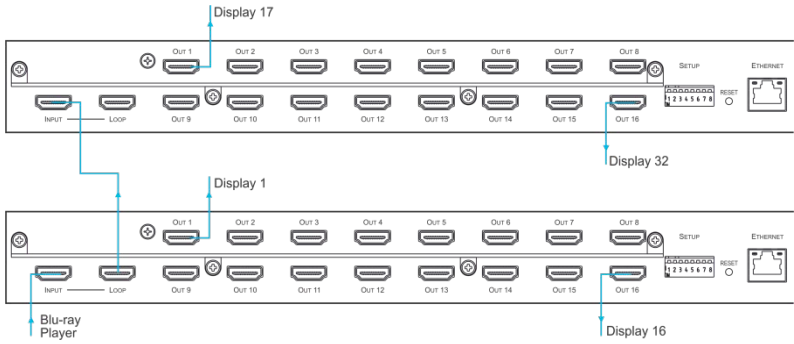

Figure 6: A Set of 2 Looped VCO-16 Units

7 Using the Kramer VCO Setup Application

Use the Kramer **VCO** Setup App to manage and send an overlay to each output.

The **VCO** Setup App allows you to take a template which can include one or more graphic files and a playback program, modify the program and settings if needed, and load the resulting overlay onto specific device outputs.

The graphic files can be prepared with any graphics program such as Adobe Photoshop, Paint.NET and so on. They can include transparency, animation and for the PSD format also editable fields.

With the playback program you can set the size and position of the overlay on the screen and control its movement across the screen as well as its transparency level. Each overlay playback program can be scheduled to appear at certain times and on certain days. You can also control the frequency and rate a playback appears.

This section describes how to:

- Install the application (see [Section 7.1](#)).
- Set the application language and add devices (see [Section 7.2](#)).
- Create an overlay and manage it (see [Section 7.3](#)).
- Create and use a schedule (see [Section 7.4](#)).

7.1 Install the VCO Setup Application

To install the **VCO** Setup App:

1. Download the **VCO** Setup App from our Website at www.kramerav.com/downloads/VCOs
2. Open the .exe file. The following message appears:

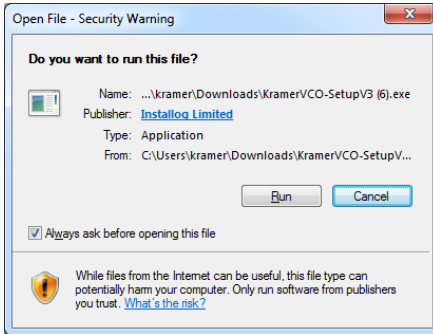

Figure 7: Installing the VCO Setup App - Warning

3. Click **Run**. The following window appears:



Figure 8: Installing the VCO Setup App – Setup Application Description

4. Click **Next>**.

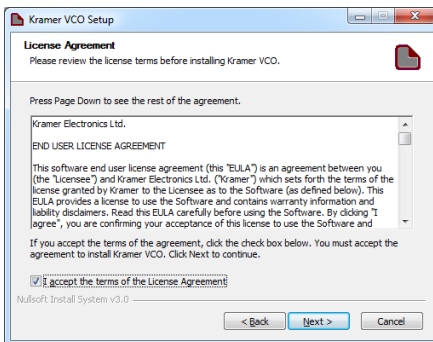

Figure 9: Installing the VCO Setup App – Legal info

5. Check for acceptance and click **Next>**.

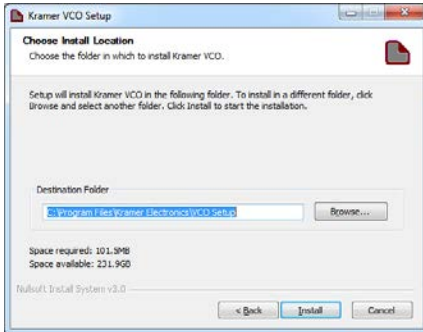

Figure 10: Installing the VCO Setup App – Setting the Destination Folder

6. Check the destination folder and change if needed then click **Install**. The software is installed:

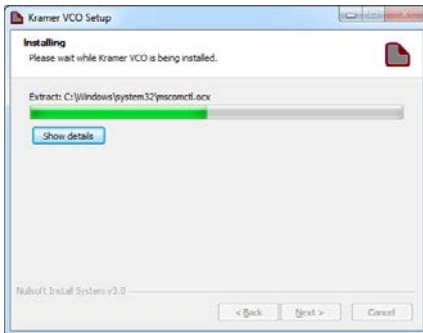

Figure 11: Installing the VCO Setup App– Installing the Software



Figure 12: Installing the VCO Setup App – Installation is Complete

7. Check **Run Kramer VCO Setup** and click **Finish**.

The Kramer **VCO** Setup App main window appears:

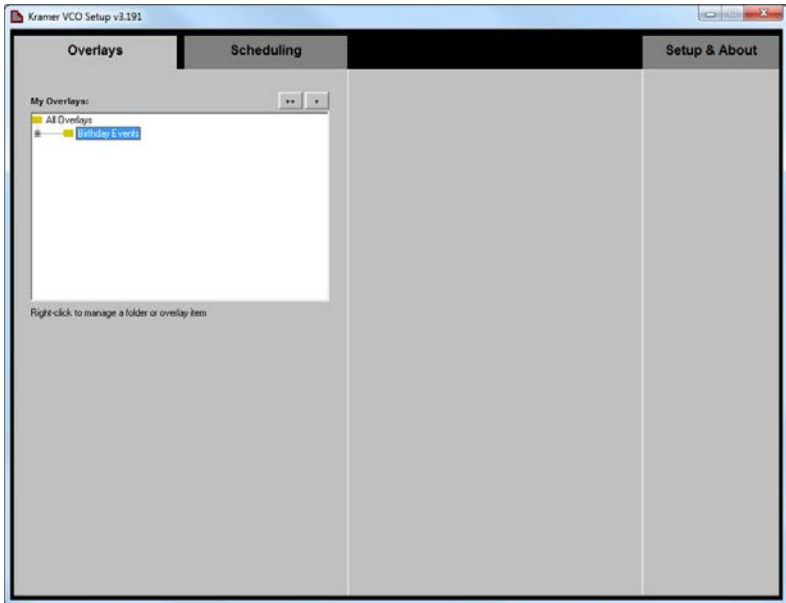

Figure 13: Installing the VCO Setup App – The Setup & About Tab

VCO Setup App includes three tabs:

- **Setup & About** – Select the application language, manage devices and read the software license agreement and description (see [Section 7.2](#))
- **Overlays** – Create templates and overlays (see [Section 7.3](#))
- **Scheduling** – Schedule the overlays per output (see [Section 7.4](#))

7.2 Setup & About

The Setup & About tab lets you set the language of the application, manage the devices and enable control of the system via an external application.

7.2.1 Setting the Application Interface Language

To change the interface language of the application:

1. Click the Setup & About tab. The Setup & About tab appears:

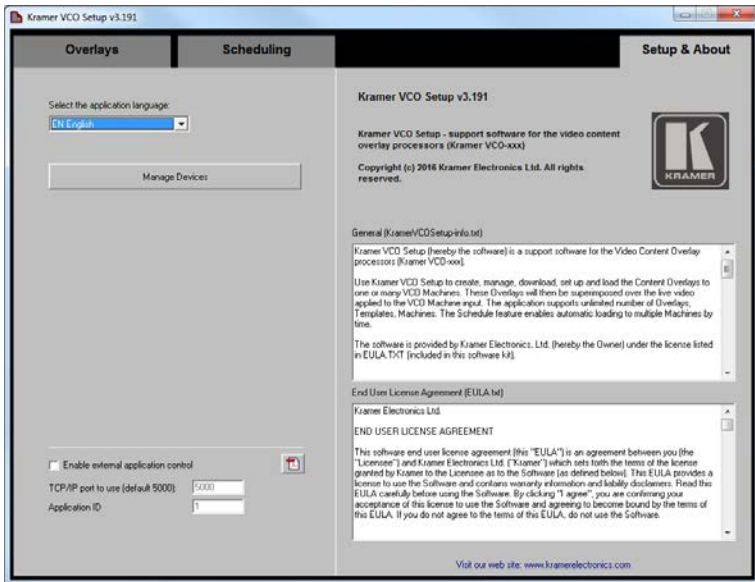

Figure 14: Setup & About Tab

2. Select the application language from the dropdown box.

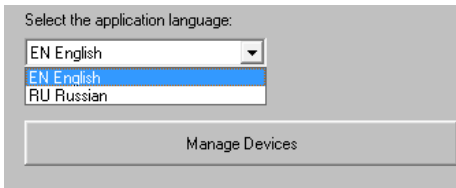

Figure 15: Setup & About – Selecting the Language

3. Restart the **VCO Setup App**.
The interface language is changed.

7.2.2 Managing Devices

To add a device to the application and manage it:

1. In the Setup & About tab, click **Manage Devices**.

The Device Wizard opens. The window on the left shows the list of the devices installed (empty in the example in [Figure 16](#)).

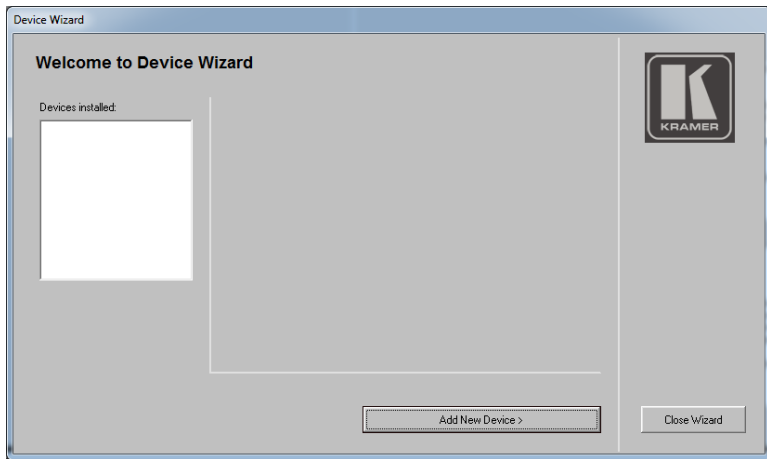

Figure 16: Welcome to Device Wizard

2. Click **Add New Device>** to add a new device to the list.

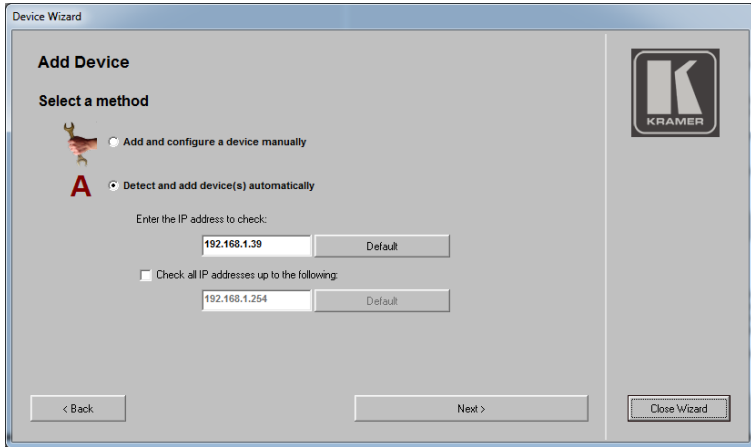

Figure 17: Device Wizard

3. Select a method to add a device:

- Manually, by entering the IP address (if you have the IP address of the device), see [Section 7.2.3](#)
- Automatically, by scanning for IP addresses up to a certain address, see [Section 7.2.4](#).

7.2.3 Add a New Device Manually

To manually add a new device to the list:

1. Check the manual option:

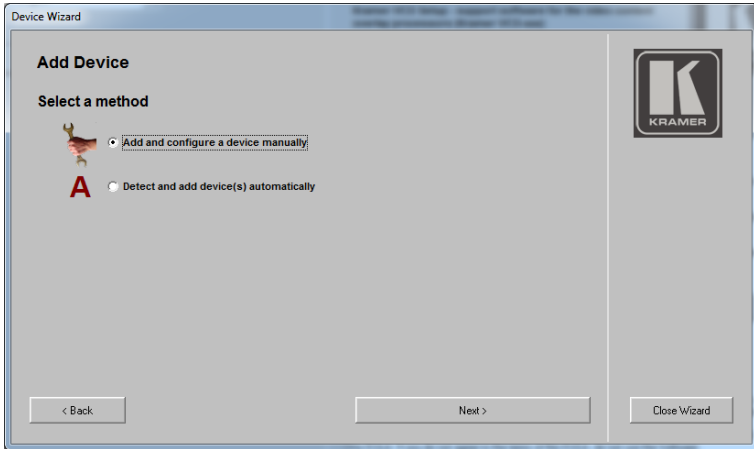

Figure 18: Device Wizard – Add Device Manually

2. Click **Next>**.

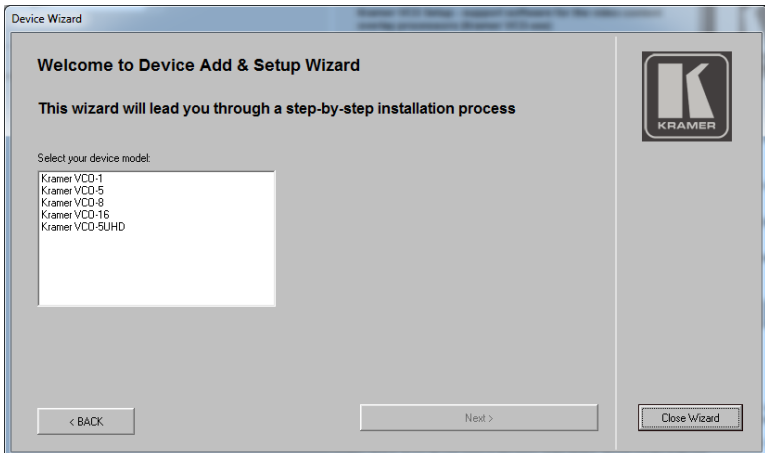

Figure 19: Device Wizard – Selecting a Device

3. Select a device.

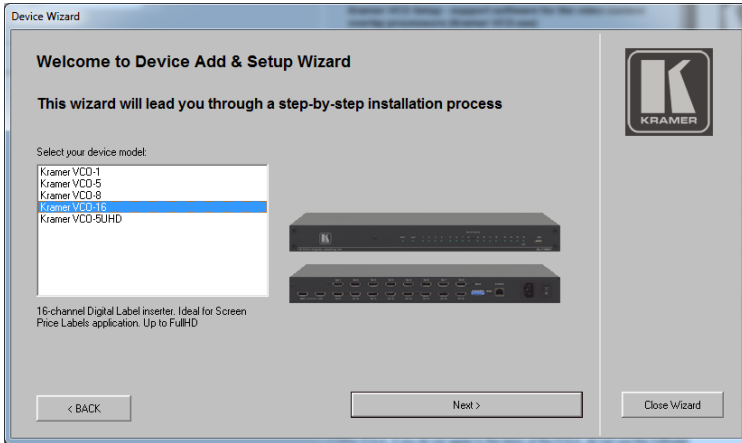

Figure 20: Device Wizard – Device Selected

In this example, **VCO-16** is selected.

The window shows a photo and a short description of the selected device.

4. Click **Next>**.

This window lets you set the IP Address.

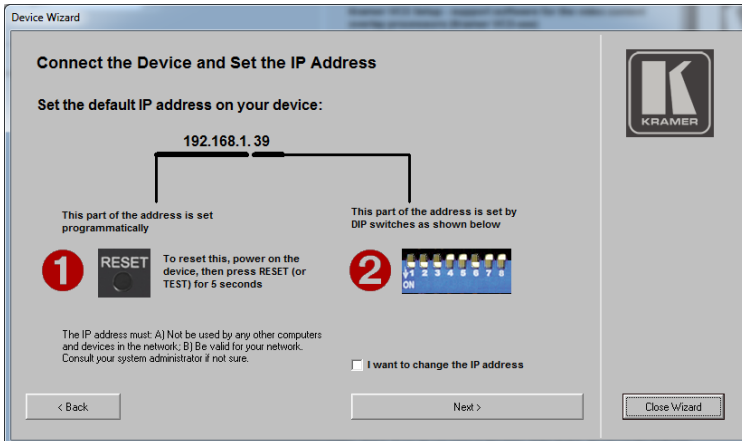

Figure 21: Device Wizard – Setting the IP Address



The last part of IP address numbers is set via the DIP-switches on the rear panel of the device (see [Section 8](#)).

The first 3 (higher) parts are set via the VCO Setup application.

5. To change the IP address, check the “I want to change the IP address” box and click **Next>**; otherwise click **Next>**.

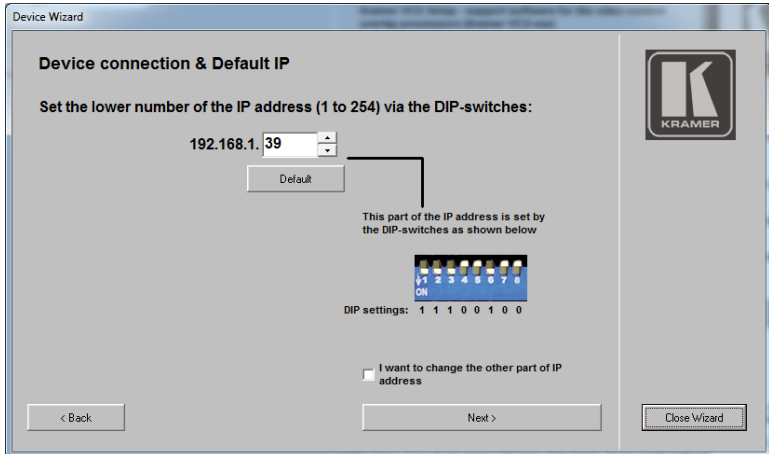

Figure 22: Device Wizard – Setting the Lower Number of the IP address.

6. Type the lower number of the IP address and view the DIP-switch setup that corresponds to the selected number (also see [Section 8.1.1](#)).



To change the IP address of the device requires that it is initially set to its default value.

7. To change the other parts of the IP address, check the change address box and click **Next>**. If you do not want to change the other parts of the IP address, keep that box unchecked and click **Next>**.

8. Follow the instructions outlined in [Figure 23](#):



Figure 23: Device Wizard – Setting the Higher parts of the IP Address

9. Connect the device as instructed and click **Next>**.

The following window appears:

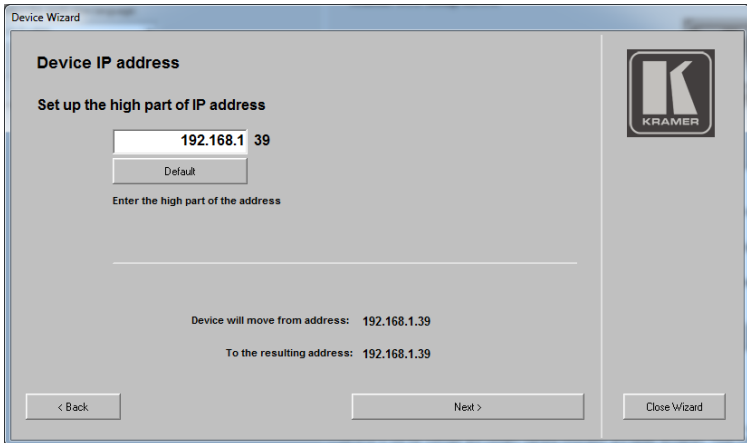

Figure 24: Device Wizard – Changing the IP Address

10. Change the number, for example, to 192.168.2.39.

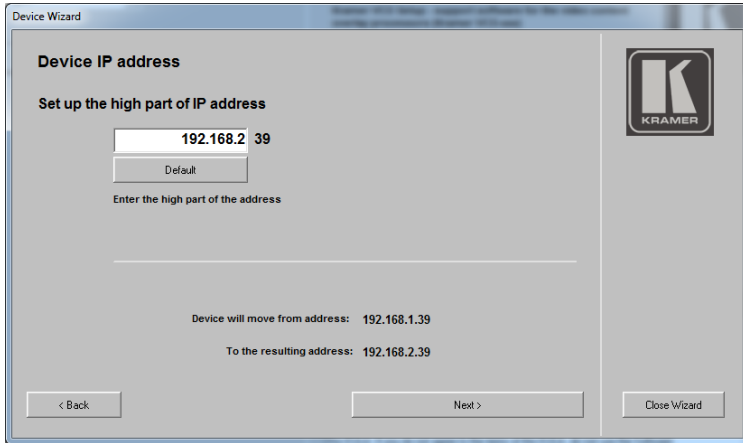

Figure 25: Device Wizard – Changing the Higher Parts of the IP Address

11. Click **Next>**. The following message appears:

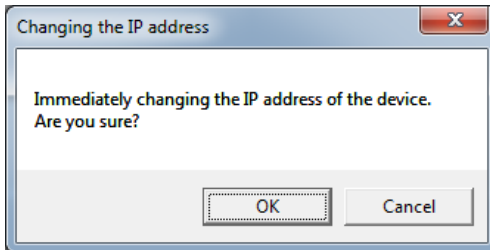

Figure 26: Changing the IP Address Message

12. Click **OK**.



You can change the first three parts of the IP Address only if the device is initially set to its default IP address. If the device is not set to its default IP address, you need to first restore the default IP address by pressing the **RESET** or **TEST** button for 5 seconds, and then you can change the IP address to the desired value.

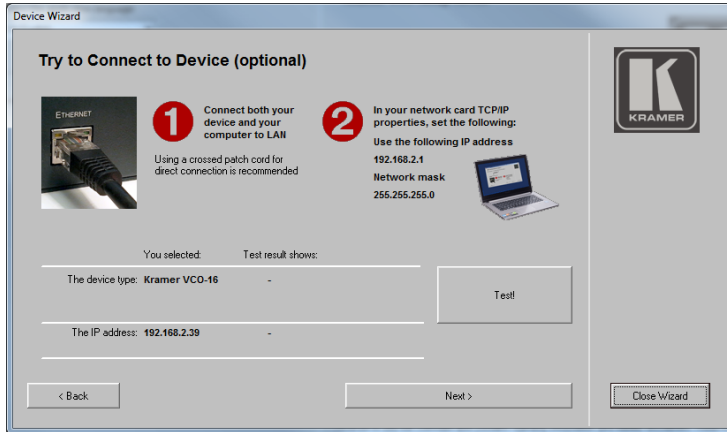

Figure 27: Device Wizard – Changing the IP Address Higher Parts

The application changes the IP address on the machine while it's connected.

13. Click **Test!** to test the connection or just click **Next>**.

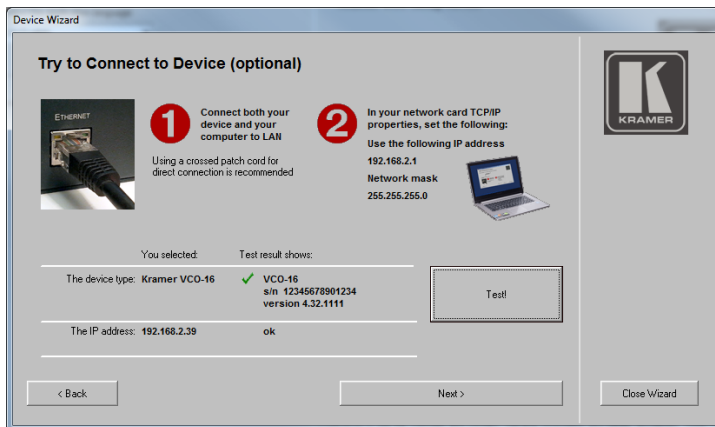

Figure 28: Device Wizard – Testing the IP Address Change

If you do not wish to change the IP address, you can connect to the device to test the connection (optional) or click **Next>**.

The device is ready to use the application.

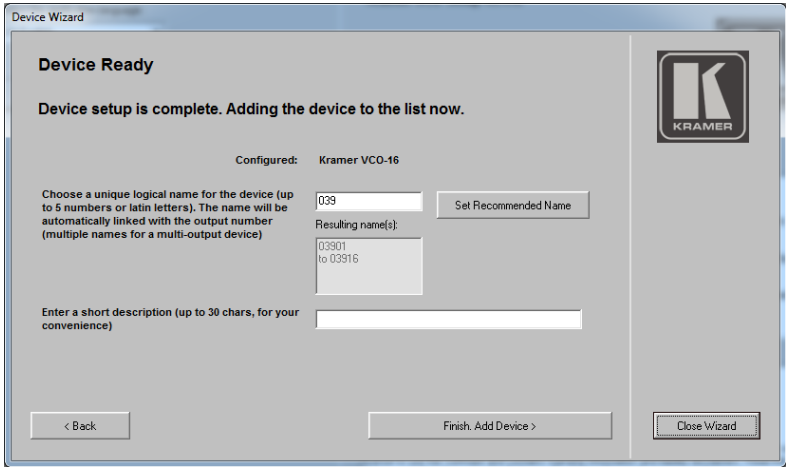

Figure 29: Device Wizard Setting the Recommended Name

You can set a name for the device (up to 5 characters) or you can set the recommended name (using the last digits of the IP address. In this example, the device name is 039 and each output is numbered in sequence: 03901, 03902, and so on). You can also add a short description to this particular device:

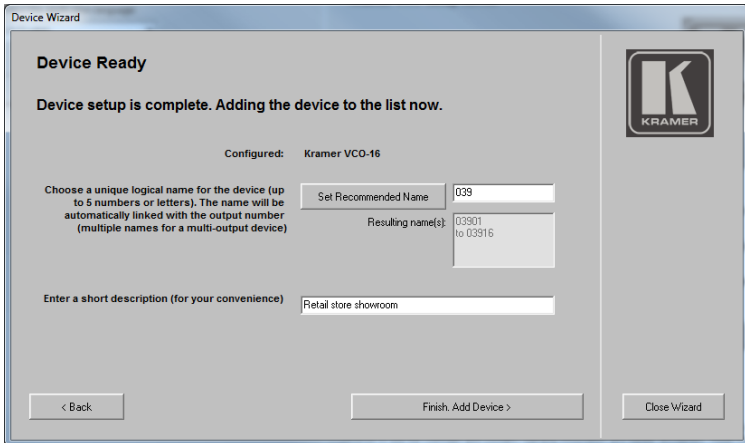

Figure 30: Device Wizard – Set the Device Name

14. Click **Finish. Add Device**>.

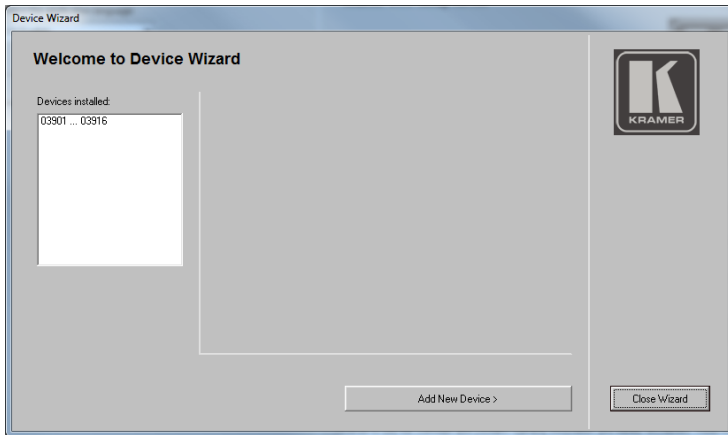

Figure 31: Device Wizard – Device Installed

15. Select a device to view its details:

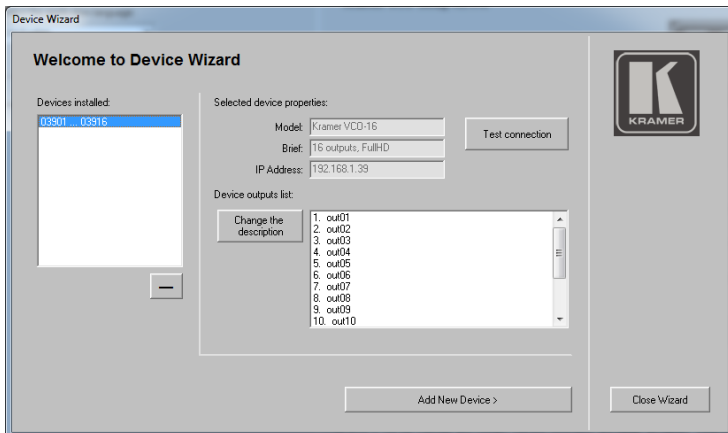

Figure 32: Device Wizard –Device Details

In the same way you can add as many devices as required.

The final page of the wizard shows the list of the devices that were installed. You can delete a selected device by clicking — below the list. This page shows the properties of the selected device and lets you change each individual output name. You can test the connection to the machine at this point.

7.2.4 Adding a Device Automatically

You can detect a device automatically by searching for a specific IP address on the Network or by scanning a range of IP addresses. To add a device automatically:

1. In the Device Wizard check Detect and add device(s) automatically.
Choose either to search for a specific IP address or scan a set range of IP addresses to detect connected devices.

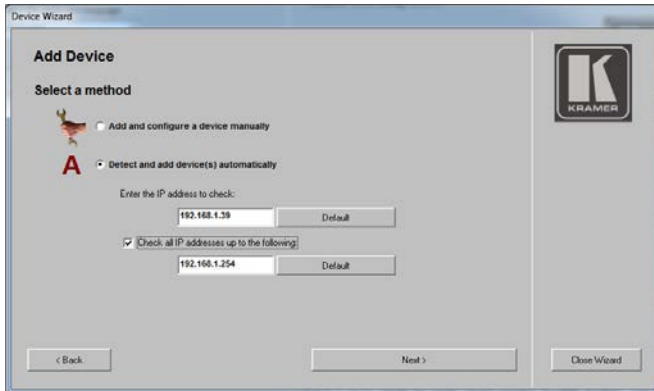

Figure 33: Device Wizard – Automatic IP Address Detection

2. Click **Next>**.

If an IP address range is defined, multiple VCO devices may be found during the scan.

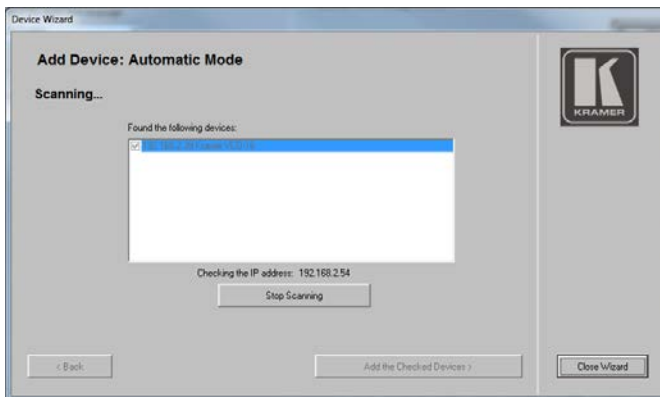

Figure 34: Device Wizard – Searching for an IP Address

3. Click **Stop Scanning** once the expected devices are found.

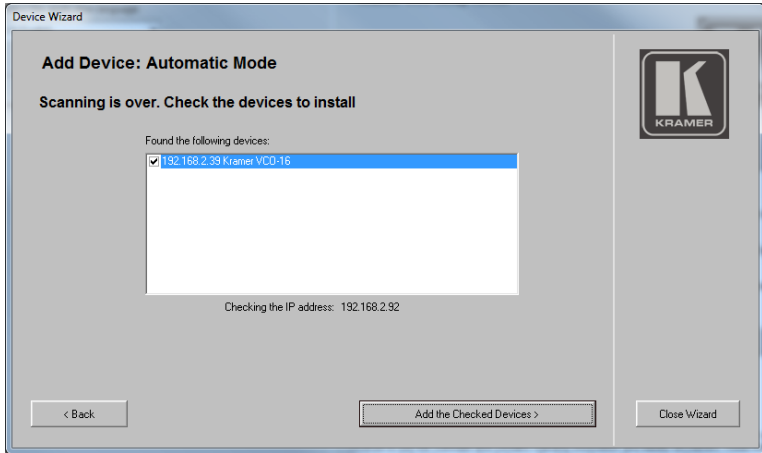

Figure 35: Device Wizard – Device IP Address Detected

4. Click **Add the Checked Devices>**.

The selected device shows its properties and output names.

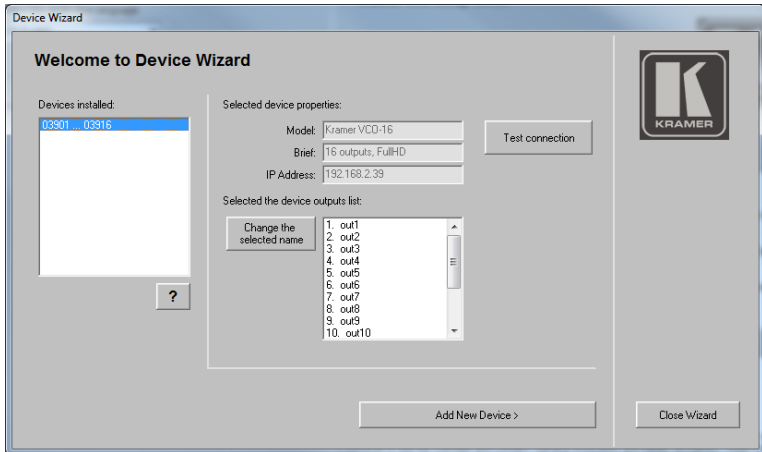

Figure 36: Device Wizard –The Device Details (following Automatic Scan)

7.3 Setting the Overlays

The Overlay tab lets you prepare overlays to use with your **VCO** devices to send to the individual outputs of the device.



You do not need to connect to a device to set the Overlays.

Specific tasks can be performed by right-clicking each file or folder in the Overlays tab and selecting one of the context-sensitive menu options:

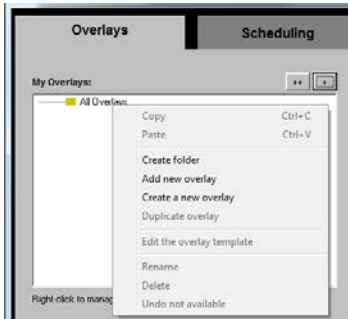

Figure 37: Setting the Overlays – Right-Clicking the All Overlays folder

Select	To
Copy	Copy an overlay
Paste	Paste an overlay
Create folder	Create new folder
Add new overlay	Create an overlay using an existing template
Create a new overlay	Create a new template for an overlay and then immediately create an overlay with this template
Duplicate Overlay	Duplicate an overlay
Edit the overlay template	Edit an existing overlay template
Rename	Rename an overlay or overlay folder
Delete	Delete an overlay or overlay folder
Undo	Undo the last action

Click **+** to add an overlay based on an existing overlay template and adjust it to your needs. Click **++** to create a new overlay. The overlay will be added to the My Overlays list.

7.3.1 Adding an Overlay from an Existing Template

To add an overlay from a template to the My Overlays list:

1. Click the Overlays tab. The Overlay tab appears:

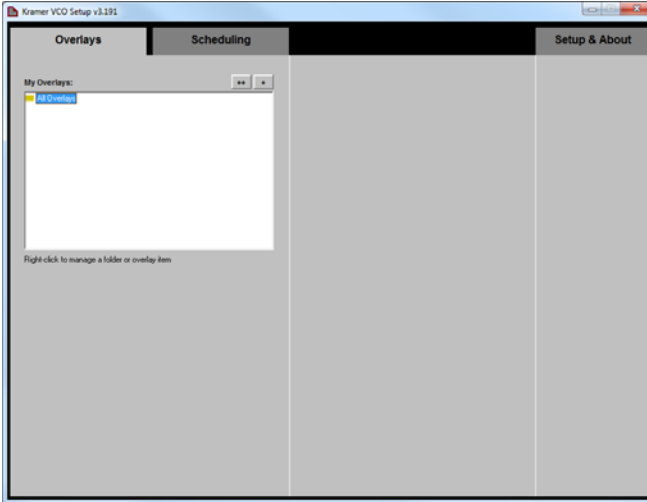

Figure 38: Setting the Overlays – the Overlay Tab

2. Right-click the **All Overlays** folder.
3. Select **Create folder** and type its name in the Create a new folder window (Birthday events in this example):

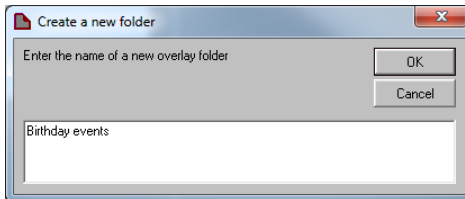

Figure 39: Setting the Overlays – Create a New Folder

The new folder is added to the list:



Figure 40: Setting the Overlays – New Folder Added



You do not need to add the new overlay to a new folder and you can just add an overlay to the main folder.

4. Click **+** or right-click the **Birthday events** folder and select **Add new overlay**. The following window appears:

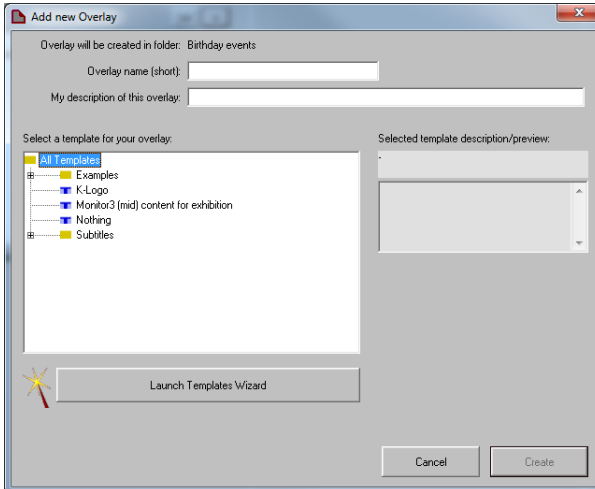

Figure 41: Setting the Overlays – the Overlay Tab

5. In the Examples Folder select **Advertisement1**. The following window shows the name of the overlay template, recommends the optimal screen size for this template, and describes its features:

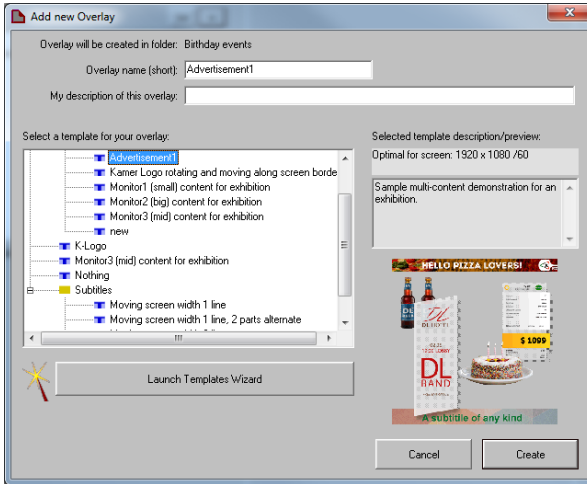

Figure 42: Setting the Overlays – the Add New Overlay Window

You can give the overlay a new name and add a description of the overlay:

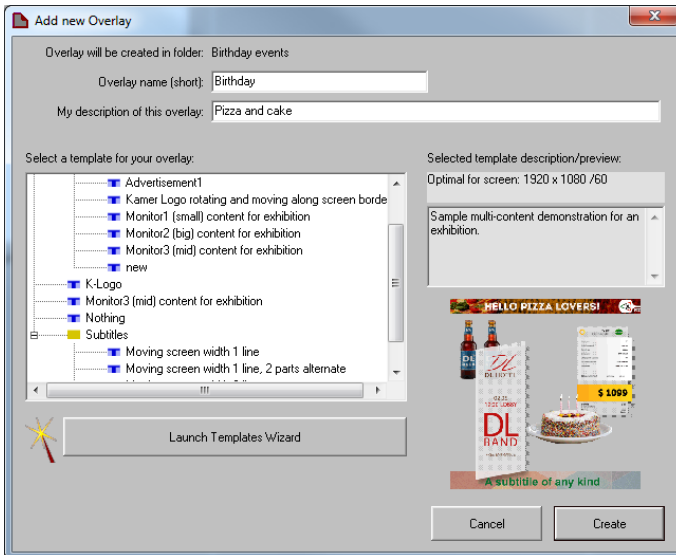

Figure 43: Setting the Overlays – Add a New Name and Description

6. Click **Create**.

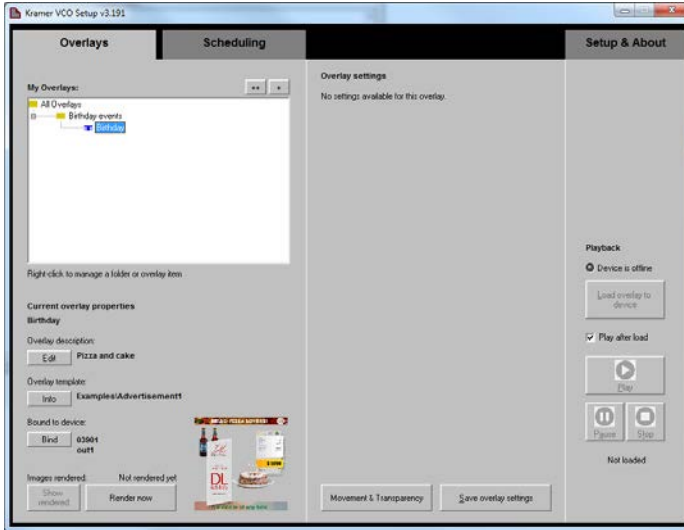

Figure 44: Setting the Overlays – The Overlay Added to the Overlay List

After adding the overlay, the overlay properties list shows the Overlay name, the description (which can be added) and the original template location (click Info to display the template summary and edit it if needed – via the template wizard, see [Section 7.3.2](#)):



Figure 45: Setting the Overlays – Template Details

7. Bind the machine as follows:

- Make sure that the devices to which you want to add the overlays are installed (see [Section 7.2](#)).
- Each overlay in the My Overlays list can be loaded to a specific output of a specific device. Therefore for each output on a device(s) you need to create a duplicate of the overlay.
To do this, select the overlay to duplicate in the My Overlays list and click **Duplicate overlay** in the right-click menu.

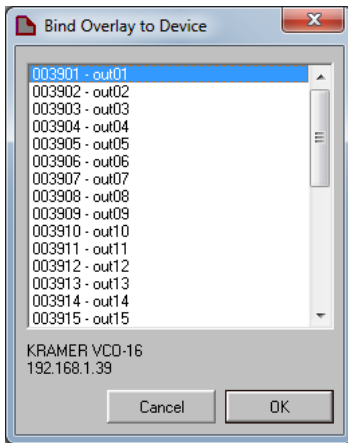

Figure 46: Setting the Overlays – Bind Overlay to Machine

For some overlays you may need to enter the Overlay settings, which are specific per overlay, as illustrated in the following example:

- Set the text, the background and background variation, the colors and other information.

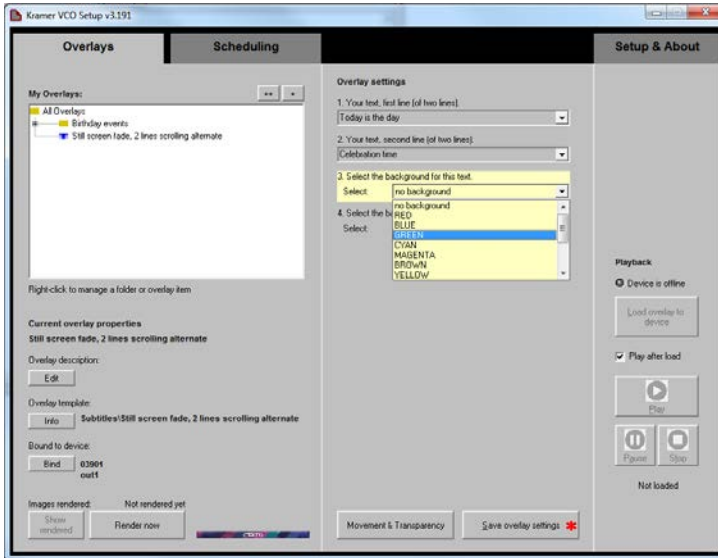

Figure 47: Setting the Overlays – the Overlay Settings

- Click **Render now** to render the image and show it.
The following message appears:

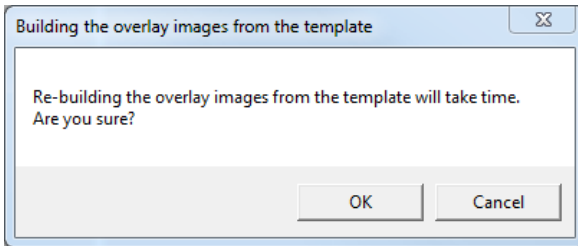

Figure 48: Setting the Overlays – Building Overlay Message

10. Click **OK**.

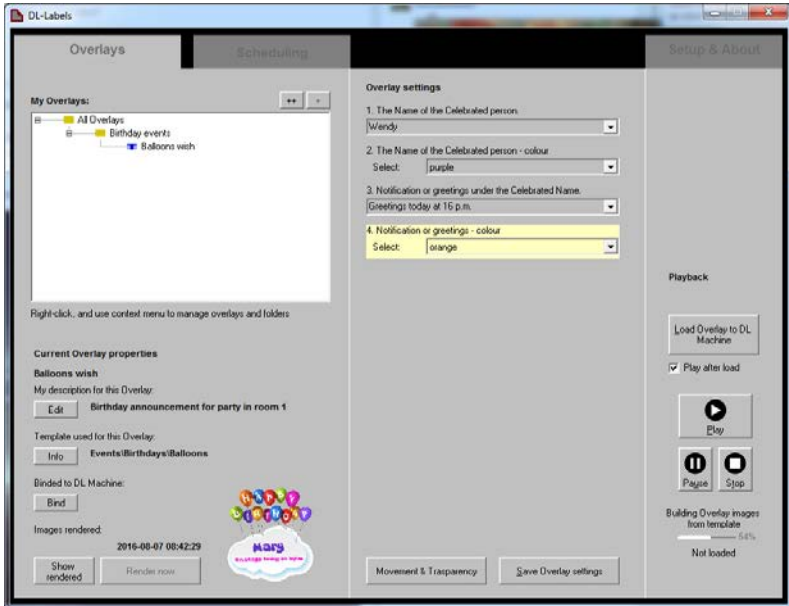

Figure 49: Setting the Overlays – Rendering the Overlay

11. Click **Show Rendered** to view the Overlay:

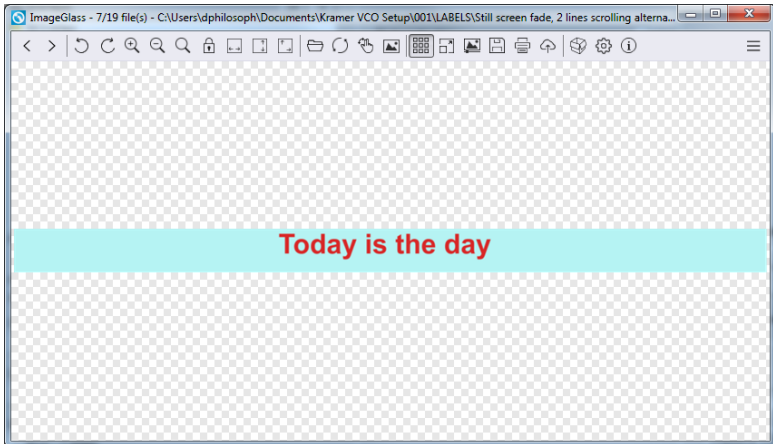

Figure 50: Setting the Overlays – View of the Overlay

7.3.2 Adding a New Overlay Based on an New/External Template

To add a new overlay based on an external template:

1. In the Overlays tab (see [Figure 37](#)), click **+**.

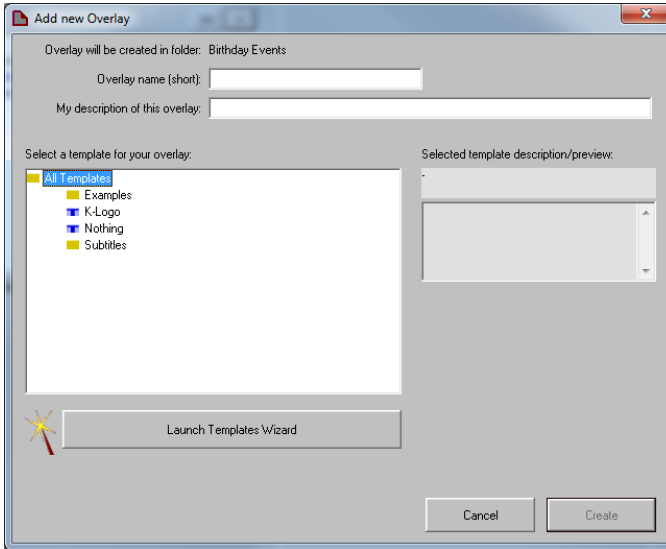

Figure 51: Adding a New/External Template – Launching the Template Wizard

2. Click **Launch Templates Wizard**. The Template Wizard appears:

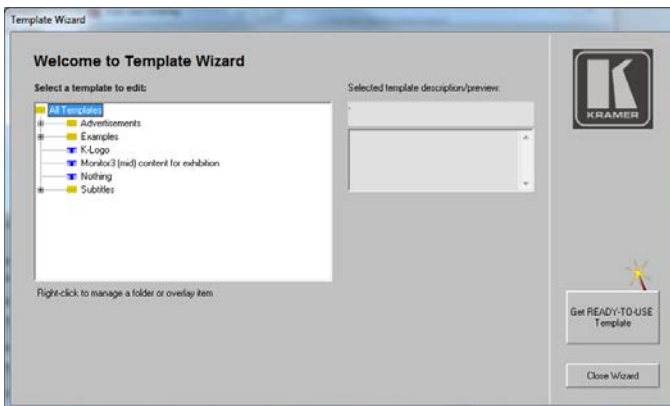

Figure 52: Adding a New/External Template – Template Wizard

The template wizard lists the available templates within the application. You can right-click a template to edit it rename or delete it. The template that is edited then appears in its new format in the overlay template list (as in [Figure 41](#))

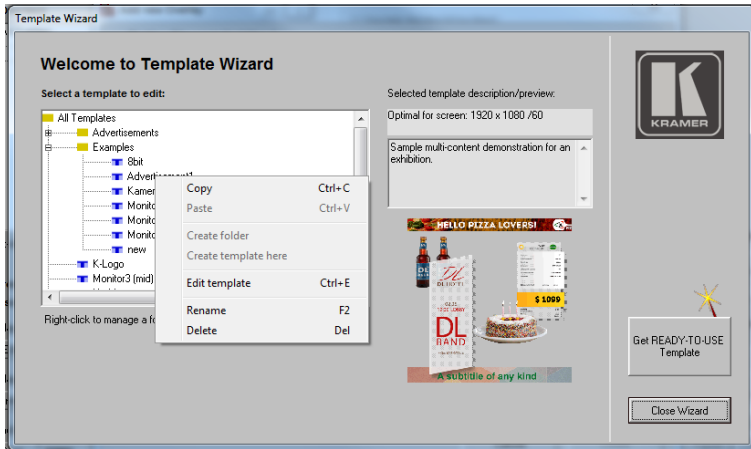

Figure 53: Adding a New/External Template – Available File Operations

Right-click a template folder to create a new folder, create a new template (see [Section 7.3.3](#)) and perform other operations.

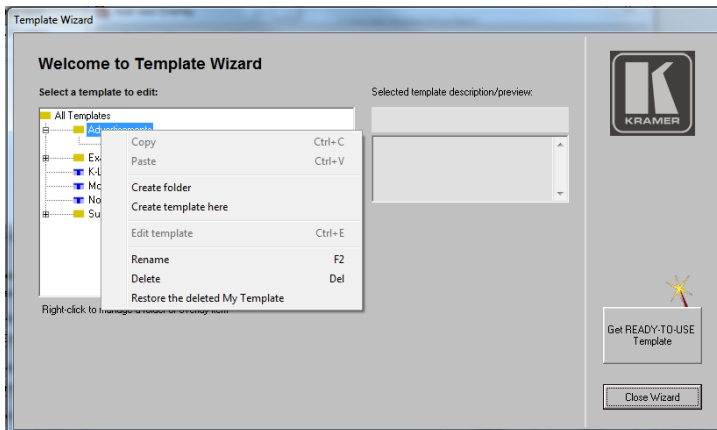

Figure 54: Adding a New/External Template – Available Folder Operations

3. Click **Get-READY-TO-USE Template** to select a template source:

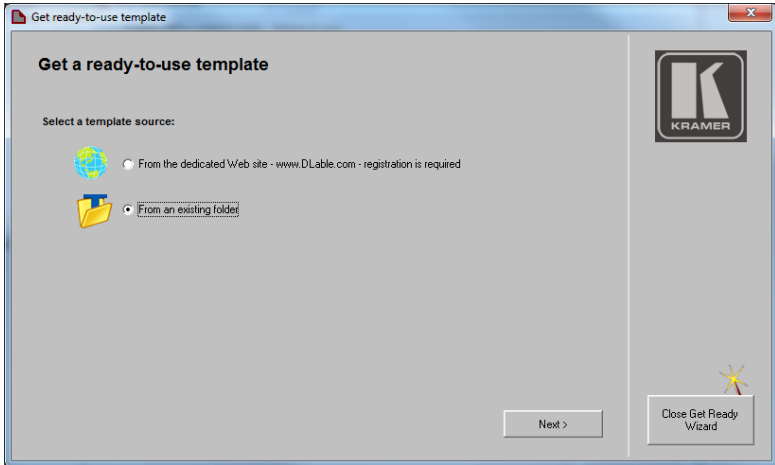

Figure 55: Adding a New/External Template – Ready-to-Use Template – External Source

4. Select **From an existing folder** (the Web site source is currently unavailable) and click **Next>**:

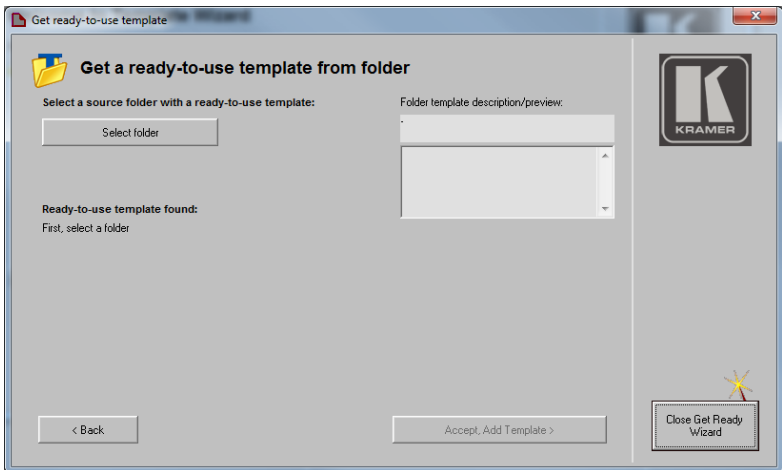

Figure 56: Adding a New/External Template – Selecting the Folder

5. Click **Select folder** to choose an external template within that folder:

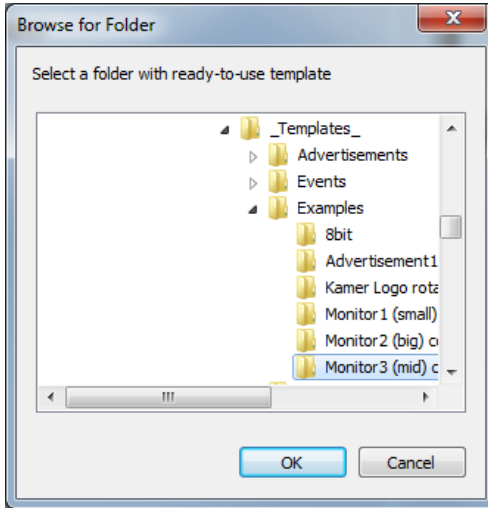

Figure 57: Adding a New/External Template – Selecting the Template

6. Click **OK**.

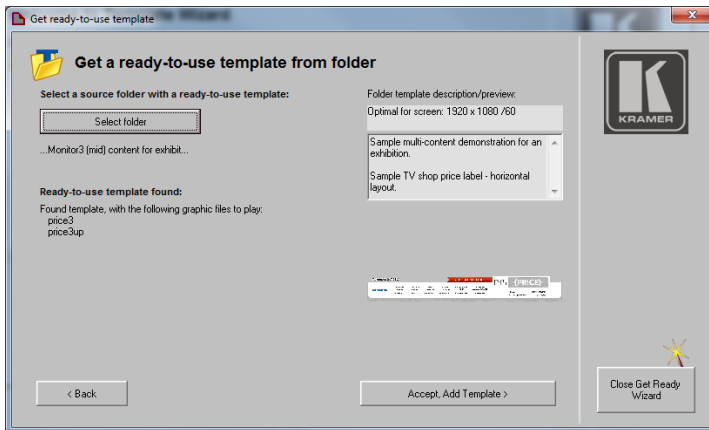

Figure 58: Adding a New/External Template – Available Operations

7. Click **Accept, Add Template>** to add the new template.

The new Template and its description are added to the list of available templates. And you can use it, edit it and so on.

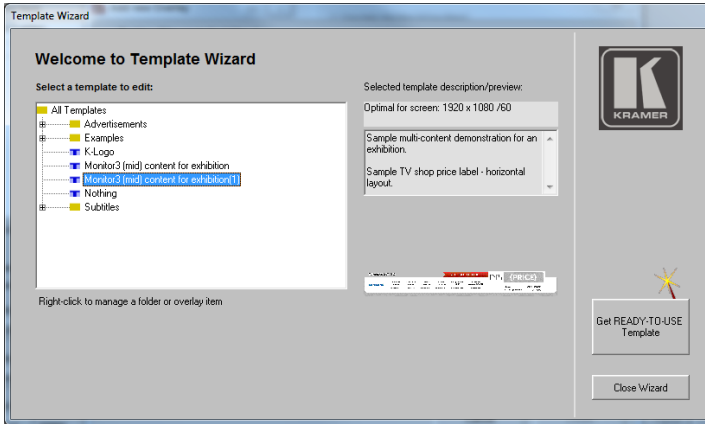

Figure 59: Adding a New/External Template – New Template Added

You can get a new external template or close the Wizard.

7.3.3 Creating an Overlay Template

To create an overlay template:

1. In the Overlays tab (see [Figure 37](#)), right-click the **All Overlays** folder and click **Add overlay from scratch** or click **++**.

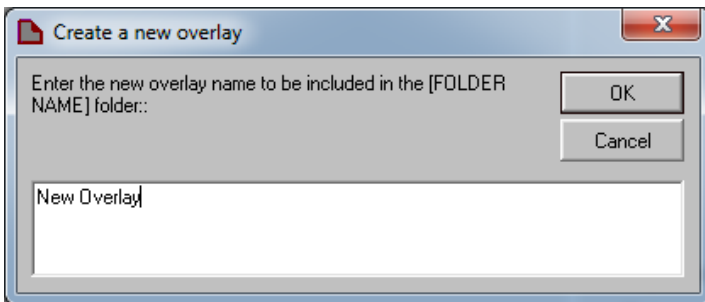

Figure 60: Creating a New Overlay

2. Type the name of the new overlay and click **OK**.

A new overlay is created based on a new template, so you need to create a new template for this overlay – thus, the Template Wizard window appears:

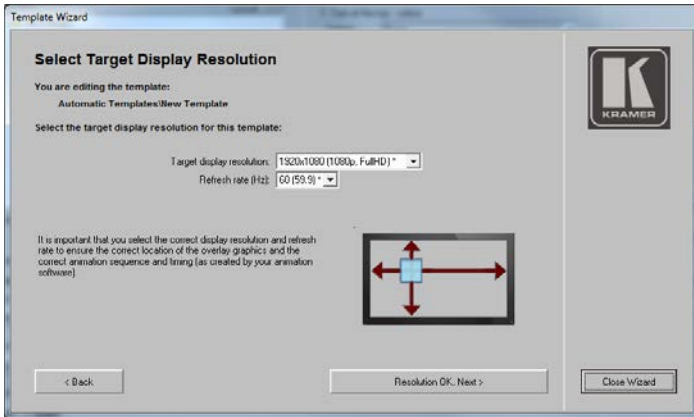

Figure 61: Template Wizard – Setting the Resolution



Selecting the appropriate resolution ensures that the overlay is located correctly on the screen, and that the animation and timing appear as programmed.

Click **<Back** or **Close Wizard** to cancel the process.

2. Click **Resolution OK, Next>**. The following window appears:

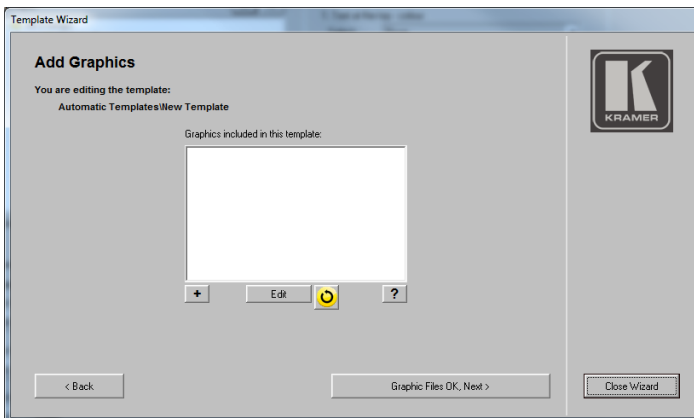

Figure 62: Template Wizard – Adding and Editing Window

2. Click + to add an image, animation and so on. The file format window appears.

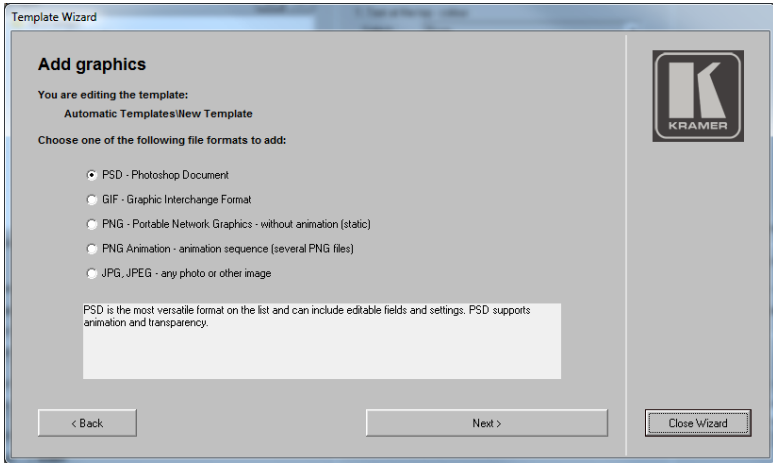

Figure 4: Template Wizard – Select a File Format

3. Select a file format, for example, PNG. The capabilities of each format are described for each selection.

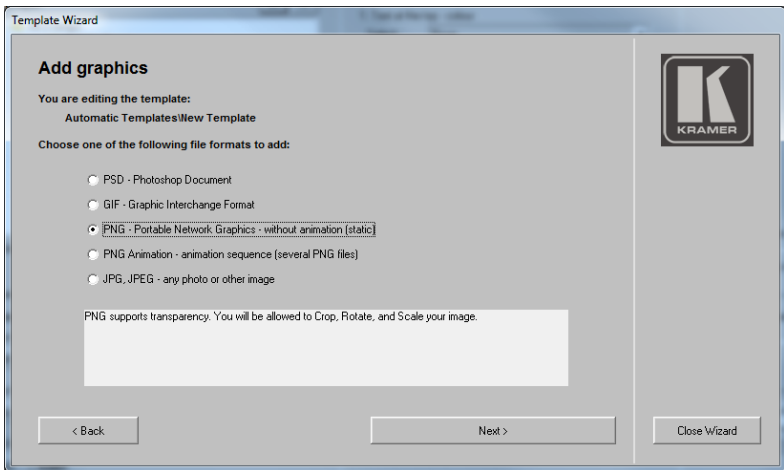

Figure 4: Template Wizard – Adding Graphics

4. Click **Next** and select a file. The selected PNG appears:

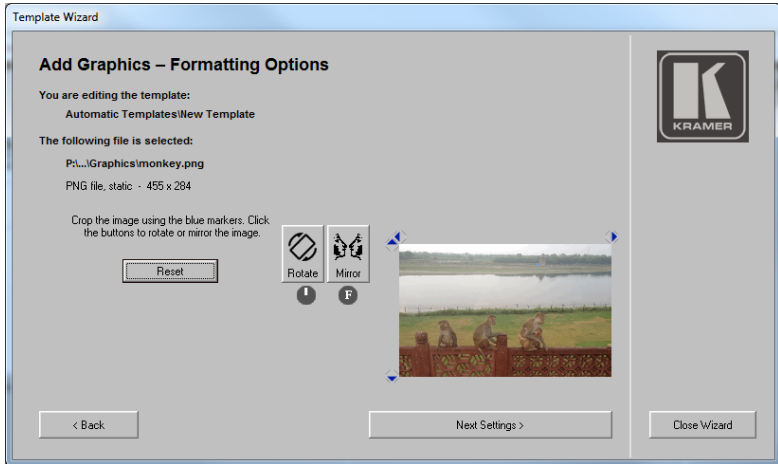

Figure 63: Template Wizard – Editing the PNG graphic

5. If required, use the Rotate and Mirror buttons to rotate and mirror the image, respectively. Click and drag the blue markers around the image to crop the image.

When using a JPG format, you can also set a transparent color and use transparency. When using a PNG format, the transparency implemented in the PNG file itself is supported (created via an external editor program).

6. Click **Next Settings**>.

This window lets you resize the image, with respect to the screen size.

VCO devices can manage images that are up to 200% of the screen size (horizontally, vertically or both).

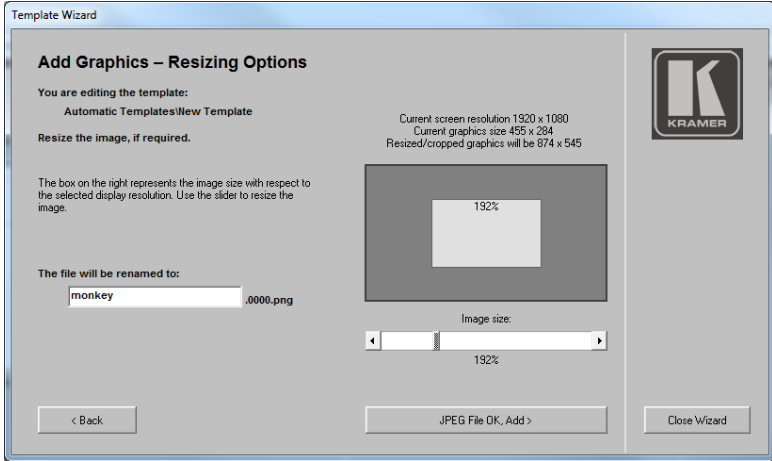

Figure 64: Template Wizard – Resizing Options

7. Click **JPEG File OK, Add**>.

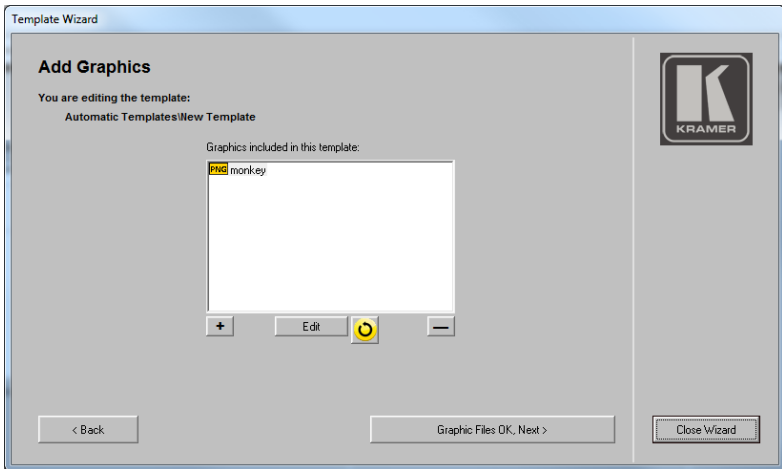

Figure 65: Template Wizard – Adding Graphics

8. Add another file, refresh the list, edit a file (via an associated external editor) or delete it if needed.



If there is no graphic application associated with a selected graphical format (for example, if you don't have any editor for the PSD format), the edit button will have no effect. If you want to edit the graphic, you need to install the appropriate program.

9. Click **Graphic Files OK, Next>**.

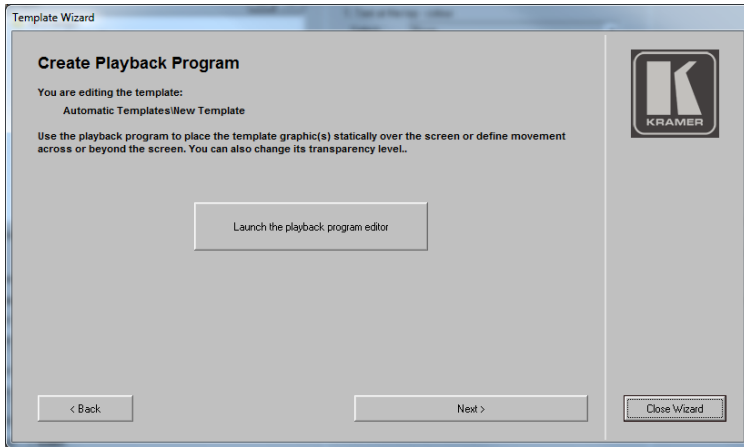

Figure 66: Template Wizard – Create Playback Program

10. Click **Launch the playback program editor**. Set the movement and transparency (see [Section 7.3.4](#)) and then click **Next>**.
Add a description of the template and view, select or edit the template preview.

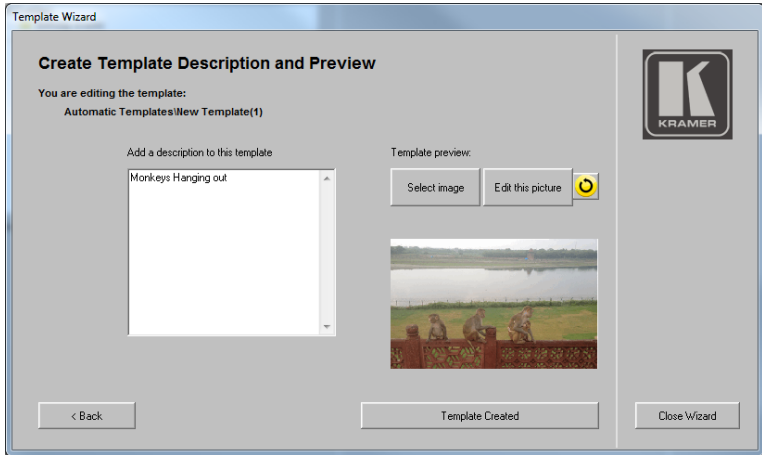

Figure 67: Template Wizard – Add Template Description and see Preview

11. Click **Template Created**.

The template is created, and the overlay (with the name assigned in the first step “New Template”) is also automatically created and added to the All Overlays list, in the selected folder.

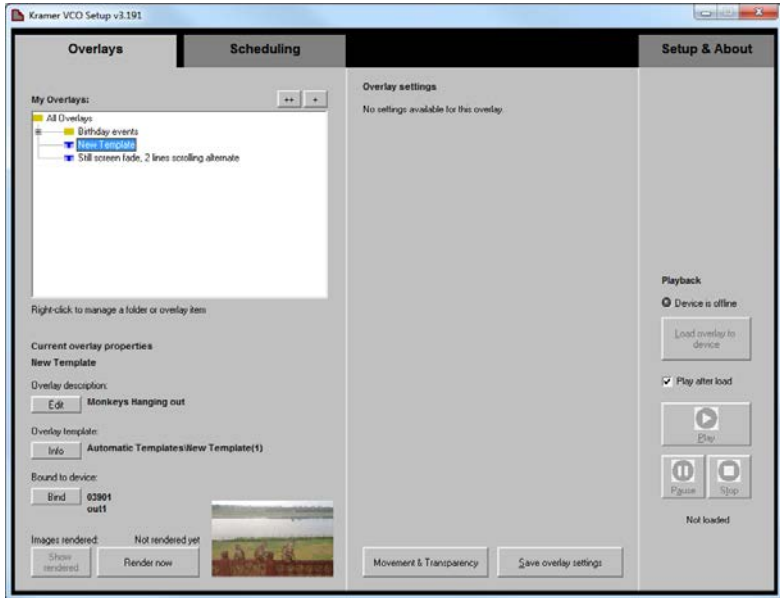

Figure 68: New Template Added

12. Click **Movement & Transparency** to program the overlay (see [Section 7.3.4](#)).

7.3.4 Movement and Transparency

The Movement & Transparency window lets you create and edit a template or an overlay program.

- When used for a template, this window defines the default playback for that template. Any overlay created from this template will have this program
- When used for an overlay, this window lets you edit the playback template for this specific overlay, resulting in an overlay program that is different from its template program

You can create multiple overlays from a template, each with different settings and playback programs. Once prepared, you can load these overlays to **VCO** devices manually or via the scheduling feature (see [Section 7.4](#)).

The following example shows how to edit an overlay program (template program editing is identical).

After setting the overlay, click **Movement & Transparency** (see [Figure 49](#)) to set the movement and the transparency of that overlay. The Program Editor window lets you set the movement of the overlay on the display and the transparency of each image in the movement sequence.

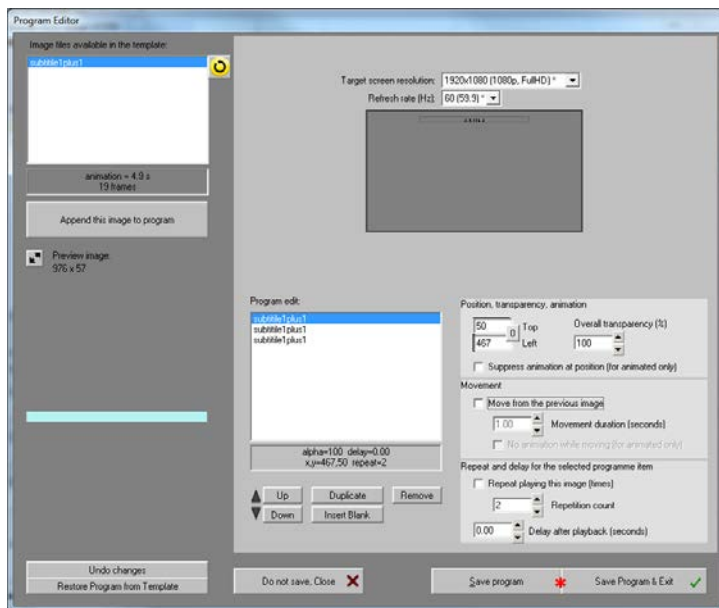

Figure 69: Setting the Movement and Transparency – the Program Editor

The image files that are available for this template appear on the left side. You can select a file from the list to add to the Program Edit window on the right side of the window. The left lower side shows the preview of the selected image (an image is available only after it is rendered via the Render now button, see [Figure 68](#), or after it is loaded to a **VCO** device).

On the right side of the window you can manage the movement and the transparency of the overlay.

Select	To
Target screen resolution and refresh rate	Select the resolution and refresh rate for the specific output display to which the overlay will be sent. It is very important to select the appropriate resolution and refresh rate to view a high quality overlay over the screen.
Display area	Shows the display area with respect to the selected resolution and a smaller STAT/ANIM area (STAT for static images/ANIM for animation) representing the overlay image.
Program edit list	Lists the overlay images. Each image on the list incorporates its specific location and transparency level, as well as its connection to the previous and next image on the list. The sequence of images in the list corresponds to the sequence these images will be presented on the screen (one by one). When the list sequence ends, the whole program will repeat itself cyclically. Using the Movement, Repeat and Delay options allows setting the time each image appears and thus the overall length of the program. You can move an image position inside the list using the Up and Down buttons below, duplicate an image (with all its attributes), remove an image or insert a blank (having the image disappear).
Position, transparency, animation	Position: Set the top (vertical) and left (horizontal) position of the overlay image. When used with the Movement option, defines the position to which the image arrives. Transparency: Set the overall transparency of the image. When used with the Movement option, defines the final transparency level of the image. For example, when used with the movement option, the image can move across the screen, appearing gradually on the screen (from 100% to 0 transparency). Suppress animation at position: If the overlay is animated (for example, flickering candles), you can disable that animation when the image stays in its final position (only the first frame of the animation is displayed). In this case, use the Delay option to setup the show-time of the image. Otherwise it will be displayed only briefly.
Movement	To create a smooth movement from one image to another, check Move from the previous image. This will also smoothly change the transparency level. Once checked, set the movement duration (in seconds). You can stop the animation while the image is moving from one point to the next.
Repeat and delay	Check the box to have the overlay repeat itself (valid for animated images only). Set the number of times the overlay repeats itself. A delay following a playback allows for a static image (or the last frame of an animated image – upon completion of the set number of repetitions) to additionally appear in its final position.
Undo changes	Undo the changes revert to the last saved program.
Restore program from template	Used for overlays only. The program will be restored from the template used for this overlay. Changes that you made manually for this particular overlay are lost after restoring from the template.
Don't save, Close	Exit without saving
Save program	Save the program without exiting (a red star appears for unsaved changes)
Save Program & Exit	Save the program and exit (a red star appears for unsaved changes)

7.3.5 Overlay Program Example

The following example shows a sequence of four images moving across the screen:

The image appears below the screen and it's 100% transparent:

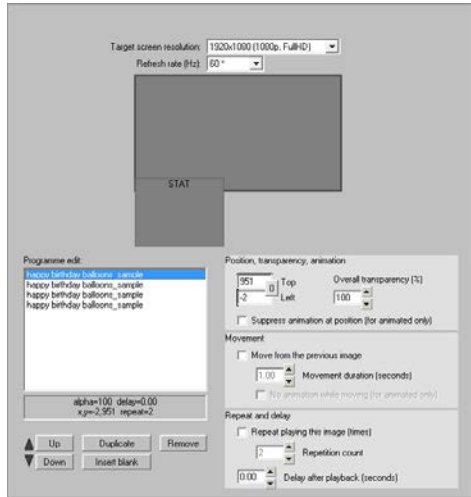

The image moves upwards. It appears gradually (60% transparency) and moves smoothly from the previous point (Move from previous image is checked) within 2 seconds:

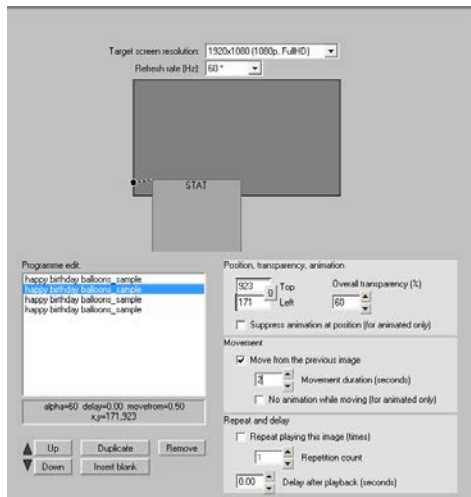

The third image is not transparent (0%) and within 5 seconds move from the previous to the current position.

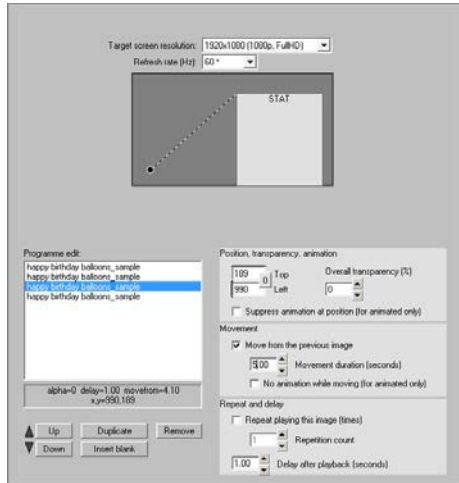

The image fades out of the screen.

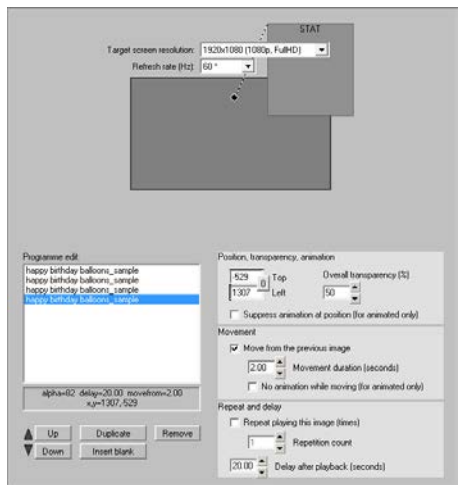

7.4 Scheduling the Overlays

Once an overlay is loaded to an output of a Kramer **VCO** device, it will keep playing on that input until a different overlay is loaded to that device/output (you can manually play, pause or stop an overlay).

The Scheduling feature lets you load overlays to devices and create playlists which automatically load lists of overlays to one or many **VCO** devices. This enables the creation of complex scenarios for multiple pre-configured overlays to load to one or many VCO devices according to a predefined schedule.

Playlist: a playlist includes a list of events that will play according to a predefined schedule. You can create multiple playlists. Each playlist is given a specific name.

Event: the event includes a list of overlays that can be bound to different **VCO** outputs. Each event can have multiple overlays. An Event is part of a playlist and can be scheduled and repeated as needed.

For example, a store playlist that includes two events, one for opening hours and the other when the store is closed (they can be called Day and Night). The **VCO** device includes eight outputs and all of them show the same images during opening hours and other images for when the store is closed. Each event includes a list of overlays that are scheduled to play at the appropriate time (this can happen at certain days in a week, at certain time each day, and so on).

There is no limit to the number of overlays that are included in an event and to the number of events that can be included in a playlist.

You can schedule an event after configuring the overlays and binding them to the outputs of **VCO** devices. If you need an overlay to be loaded to several **VCO** devices (outputs), you need to duplicate these overlays and bind them to other devices (outputs).



We recommend that you logically create folders and subfolders in the My Overlays list for the different overlays and outputs to make it easy to navigate between duplicate overlays.

To schedule an overlay:

1. Select the Scheduling tab. The Scheduling tab appears.
2. Click + next to My Playlists to add a new playlist name. The Playlist name appears under My Playlists:

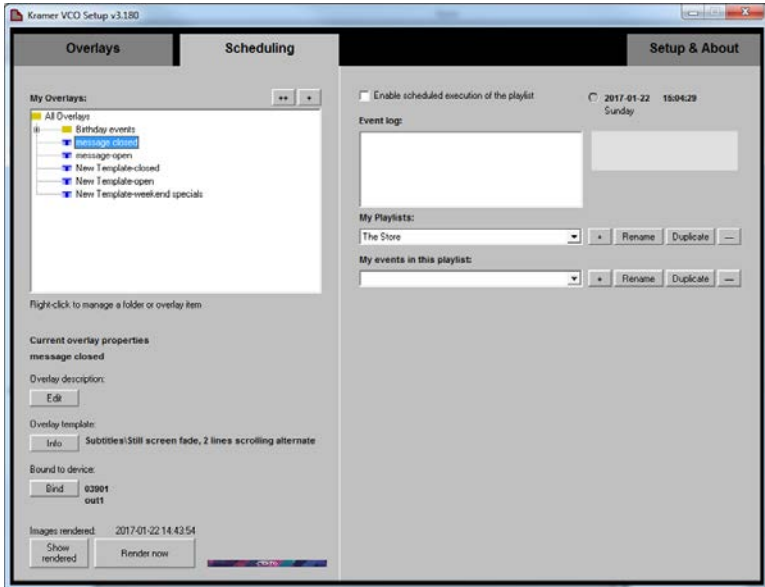

Figure 70: Scheduling Tab

3. Add an event to the playlist:

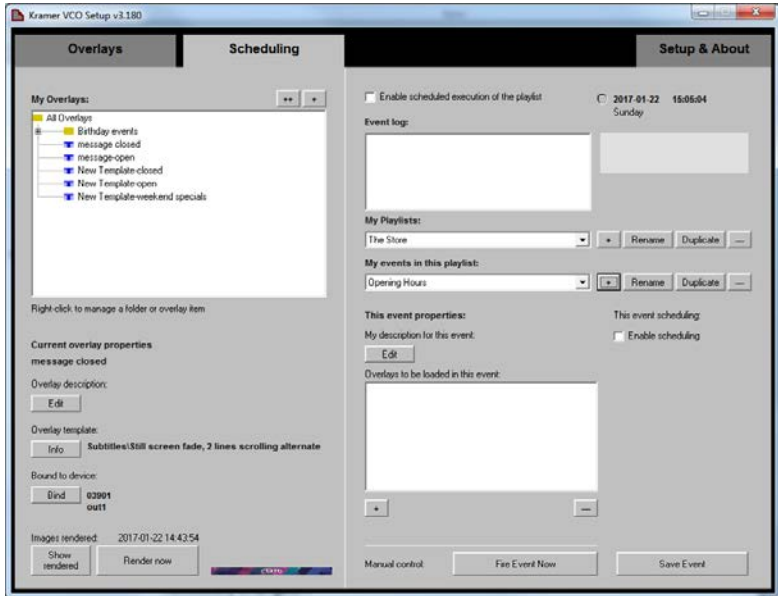

Figure 71: Scheduling – Adding an Event



You may create as many events as you need. We recommend that you create one event first and then you can duplicate it and make the necessary changes.

4. Select an overlay from the My Overlays list and then click + sign below to load overlays to the event:

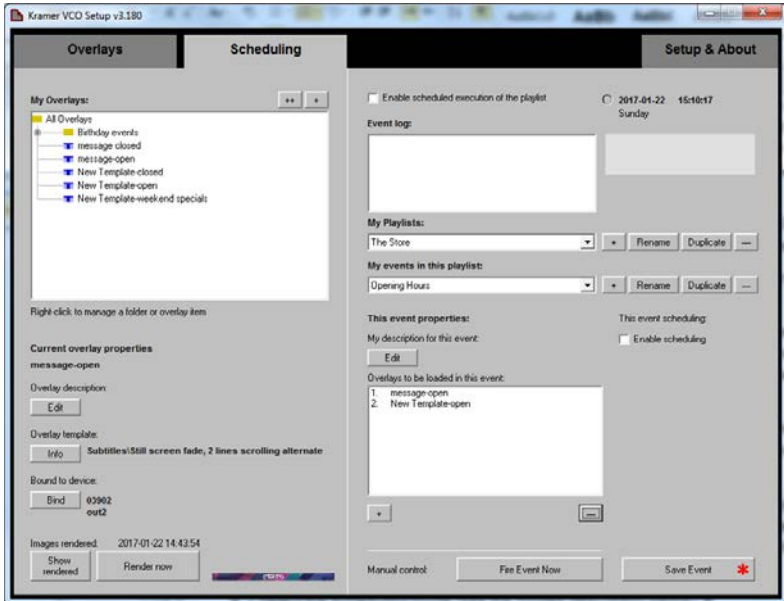

Figure 72: Scheduling – Adding Overlays to the Event



Each overlay in an event is bound to a unique output of a **VCO** device, and when this event is activated, this overlay runs in the specific output. If, for example, two overlays that are bound to the same output appear in an event, a conflicting message appears.

5. Click **Save Event**.

6. Click **Fire Event Now** to make sure that the event list is OK.

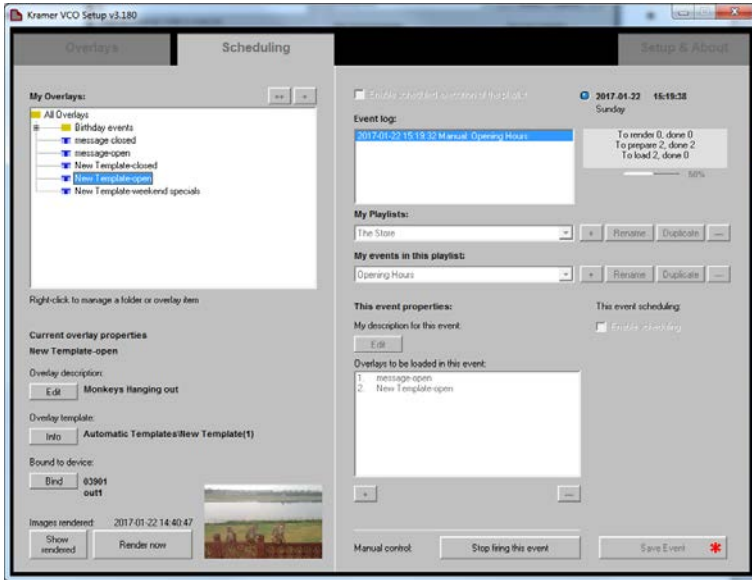

Figure 73: Scheduling – Firing an Event



You can also use fire event just to load a number of overlays with one click.

7. Check **Enable scheduling** to enter scheduling mode (see [Section 7.4.1](#)).

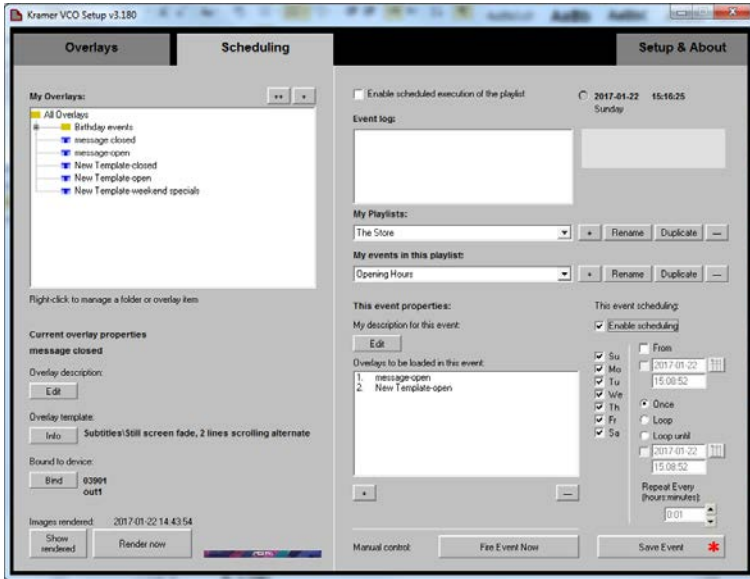

Figure 74: Scheduling – Enable Scheduling



Check Event scheduling to fire all the events in the playlist. When unchecking the box, the event ceases to run and can be fired again by checking the box.

8. Click **Save Event** (appears with a red star when there are unsaved changes to the event).

7.4.1 Scheduling Modes

Each event in the playlist can be set to a different mode. The following table defines the available scheduling modes:

Selecting the days of a week

Applies to all scheduling modes.

To set: check the days of the week for the event to fire.

Your event will fire only at the day of the week that is checked.

Uncheck a weekday to prevent firing of an event on that day.

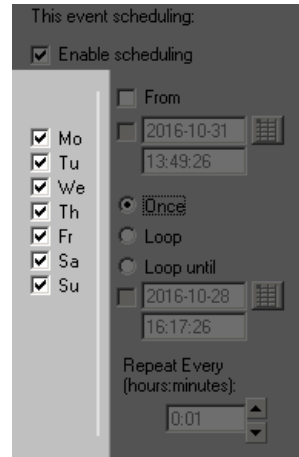

This event scheduling:
 Enable scheduling

From
 2016-10-31
13:49:26

Once
 Loop
 Loop until
 2016-10-28
16:17:26

Repeat Every (hours:minutes):
0:01

Days of the week: Mo, Tu, We, Th, Fr, Sa, Su (all checked)

Once, when scheduling mode starts

The event fires once when scheduling mode starts (that is when you check the Enable scheduling execution option).

To set: select **Once** and uncheck **From**.

Recommended use: when initializing **VCO** devices with some default overlays, when the whole system starts. For example, for such an event you may configure overlays based on the "Nothing" template (see [Figure 41](#)); this configuration will remove any overlay from the **VCO** devices.

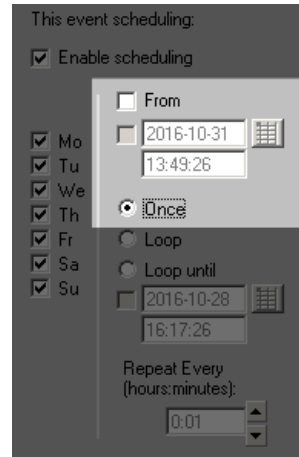

This event scheduling:
 Enable scheduling

From
 2016-10-31
13:49:26

Once
 Loop
 Loop until
 2016-10-28
16:17:26

Repeat Every (hours:minutes):
0:01

Days of the week: Mo, Tu, We, Th, Fr, Sa, Su (all checked)

Once, at the selected date and time

The event will fire once at the selected date and time. If this date/time is missed, the event will not fire.

To set: Select **Once** and check **From**; select or enter the date and time.

Recommended use: any one-time event that is scheduled for the future, such as a wedding announcement: "Wanda and Bill's wedding".

This event scheduling:

- Enable scheduling
- From
- 2016-10-31 [calendar icon]
-
- Once
- Loop
- Loop until
- 2016-10-28 [calendar icon]
-
- Repeat Every (hours:minutes):
-

Once, every day

The event will fire every day at the selected time.

To set: Select **Once**, check **From**, uncheck the date and enter the time.

Recommended use: any everyday event, such as the opening of a store, or a lunch break, or the start of an evening show, and so on.

In this example, the event will fire each day at 13:49:26.

This event scheduling:

- Enable scheduling
- From
- 2016-10-31 [calendar icon]
-
- Once
- Loop
- Loop until
- 2016-10-28 [calendar icon]
-
- Repeat Every (hours:minutes):
-

Repeat, since scheduling is started

The event will fire when scheduling mode is started, and then will repeat with a selected period.

To set: Select **Loop**, uncheck **From**, enter the firing rate in **Repeat Every**.

Recommended use: any repeated event, for which a start time or date are not important. This mode is rarely used, as in most cases such an event can interfere with other, more deterministic events in the system.

In this example, the event will fire every 1 hour and 20 minutes.

This event scheduling:

Enable scheduling

From

2016-10-31 [calendar icon]

13:49:26

Once

Loop

Loop until

2016-10-28 [calendar icon]

16:17:26

Repeat Every (hours:minutes):

1:20

Repeat, from a selected date and time

The event will fire at the selected date and time, and then will repeat at a certain rate.

If the selected date was missed, the event will start firing at the selected time of the nearest possible day.

Every other day, the event will re-synchronize itself with the selected time.

This means that, if the selected start time will arrive before the time of firing according to the repeat rate, then the event will fire at the selected time, and the repetitions will re-start from that time.

To set: Select **Loop**; check **From**; select or enter date; enter time; enter period in **Repeat Every**.

Recommended use: any repeated event with no stop time limit. For example, you may interweave this event and another repeated event. Just set these events to different start times (for example, set the first event to 8:00 and the other to 8:30). Set both events to the same repeat rate (1 hour, for example). This will result in altering the overlays from one to another every 30 minutes.

This event scheduling:

Enable scheduling

From

2016-10-31 [calendar icon]

13:49:26

Once

Loop

Loop until

2016-10-28 [calendar icon]

16:17:26

Repeat Every (hours:minutes):

1:20

Repeat, until the selected date and time

Same as Repeat (scheduling starts, at the set date and time and repeats at a set rate), but with a stop date and time.

To set: Set any of the above Repeat modes, then select **Loop until** and then select or enter date and time.

When the “Loop until” selected date and time is reached, the event will cease to fire. Note that “Loop until” date and time should be later than the “From” date and time (if in use), otherwise the event will never fire.

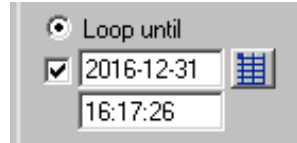

The screenshot shows a configuration window with the title "Loop until". It contains a checked checkbox, a date field with the value "2016-12-31", and a time field with the value "16:17:26". A calendar icon is visible to the right of the date field.

Repeat, until the selected time

Same as Repeat (scheduling starts, at the set date and time and repeats at a set rate), but with a stop time.

To set: Set any of the above Repeat modes, then select **Loop until**, uncheck date and enter a stop time.

On the next day, it will start firing again (if scheduled), and stop firing at the selected “Loop until” time.

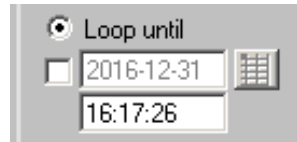

The screenshot shows a configuration window with the title "Loop until". It contains an unchecked checkbox, a date field with the value "2016-12-31", and a time field with the value "16:17:26". A calendar icon is visible to the right of the date field.

8 Defining an IP Address for a Device

When a static IP address is used, the first three numbers of the address are defined via the labeling software and the fourth number is set by the DIP-switches on the rear panel of the machine (see [Figure 75](#)). This is very useful when setting labels for large systems.

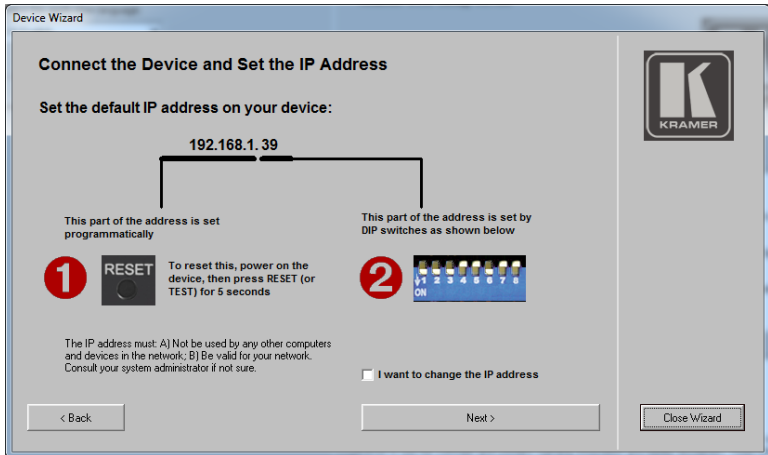

Figure 75: Setting the IP Address



8.1 Setting a Static IP Address



The first three IP numbers are set via **VCO** Setup Application Machine Wizard (see [Section 7.2.3](#)), or via K-Upload (see [Section 8.1.2](#)) and the last number is set by the DIP-switches (see [Section 8.1.1](#)). You can also set the DHCP mode (see [Section 8.1.3](#))

8.1.1 Using the DIP-Switches

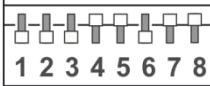
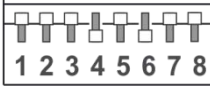
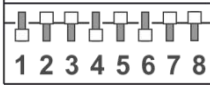
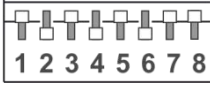
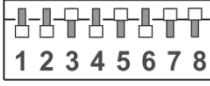
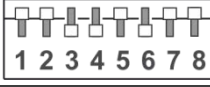
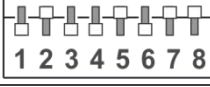
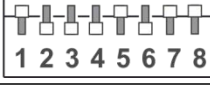
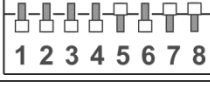
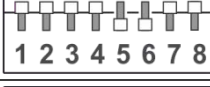
The last IP number is set by the DIP-switches at the rear of the machine (in binary code, 8 bits). Use 8-bit binary code for this number (DIP#1 is LSB, DIP#8 is MSB). Valid numbers are 1 to 254 (default factory setting is 39).

The following are examples of IP address setups of the last number of the IP address (192.168.1.XXX):

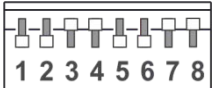
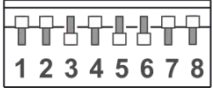
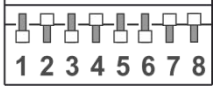
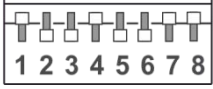
IP Address (192.168.1.XXX)	DIP-Switch Setup (1=On; 0=Off)	
39	 <p>ON ↓</p>	11100100
40	 <p>ON ↓</p>	00010100
41	 <p>ON ↓</p>	10010100
42	 <p>ON ↓</p>	01010100
43	 <p>ON ↓</p>	11010100
44	 <p>ON ↓</p>	00110100
45	 <p>ON ↓</p>	10110100
46	 <p>ON ↓</p>	01110100
47	 <p>ON ↓</p>	11110100
48	 <p>ON ↓</p>	00001100
49	 <p>ON ↓</p>	10001100
50	 <p>ON ↓</p>	01001100

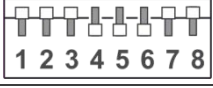
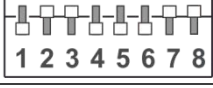
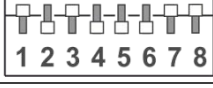
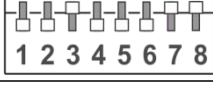
IP Address (192.168.1.XXX)	DIP-Switch Setup (1=On; 0=Off)	
51	 ON	1 1 0 0 1 1 0 0
52	 ON	0 0 1 0 1 1 0 0
53	 ON	1 0 1 0 1 1 0 0
54	 ON	0 1 1 0 1 1 0 0
55	 ON	1 1 1 0 1 1 0 0
56	 ON	0 0 0 1 1 1 0 0
57	 ON	1 0 0 1 1 1 0 0
58	 ON	0 1 0 1 1 1 0 0
59	 ON	1 1 0 1 1 1 0 0

8.1.2 Restoring the Default IP Address via K-Upload

The first three parts of the IP address can be changed via the **VCO** Setup application. In this case, this part of the address can be changed only after the device is set to its default IP address.

To reset the IP Address:

1. Power on the device, while pressing the RESET (or TEST for VCO-1) button for 5 seconds.

2. Follow the Machine Wizard instructions to set up a new address (see [Section 7.2.3](#)).

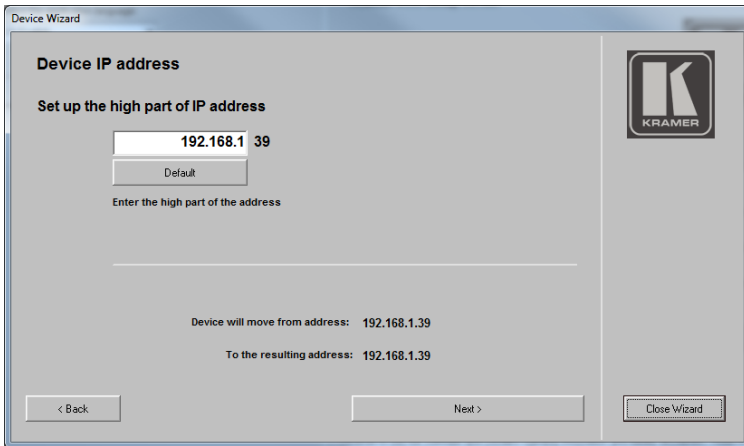

Figure 76: Setting the High Parts of the IP Address

The first three numbers of the IP address are set via the Kramer **K-Upload**. The factory default is set to: 192.168.1.39 (the last number is set via the DIP-switches).

To set the first three IP address numbers do the following:

1. Start K-Upload.
2. Check that the PC network card is set to the same address pool (for example, to 192.168.1.1) as the known current address of a **VCO** device.
3. In the main window click **Connect**. The Connect window appears.
4. Enter the current machine IP number and click **Connect**.

- In the Device Properties area change the first three numbers of the IP address (you do not need to change the fourth number as it is set via the DIP-switches).

Note that you might also need to change the Gateway and Mask.

- Click **Save**.

The first three numbers of the IP address are saved.

8.1.3 The DHCP Mode

Some LAN networks may require the use of DHCP mode for the machine. In the DHCP mode, a DHCP server will assign all IP settings to your machine. To set the machine to the DHCP mode set the DIP-switches on the machine to OFF:

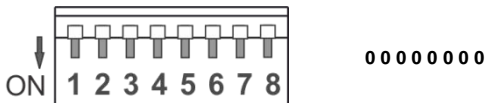

Figure 77: DHCP Mode DIP-Switch Setup

The machine can be identified in the network via its MAC address (which is printed on the label that is attached to the underside of the machine), and by the network name ("KRAMER_xxxxxx", with xxxxxx representing the last 6 hexadecimal digits of the MAC address of this device).

8.2 Operating via the Ethernet

You can connect to the **VCO-1**, **VCO-8**, **VCO-16** via Ethernet using either of the following methods:

- Directly to the PC using a crossover cable (see [Section 8.2.1](#))
- Via a network hub, switch, or router, using a straight-through cable (see [Section 8.2.2](#))

Note: If you want to connect via a router and your IT system is based on IPv6, speak to your IT department for specific installation instructions.

8.2.1 Connecting the Ethernet Port Directly to a PC

You can connect the Ethernet port of the **VCO-1**, **VCO-8**, **VCO-16** directly to the Ethernet port on your PC using a crossover cable with RJ-45 connectors.



This type of connection is recommended for identifying the **VCO-1**, **VCO-8**, **VCO-16** with the factory configured default IP address.

After connecting the **VCO-1**, **VCO-8**, **VCO-16** to the Ethernet port, configure your PC as follows:

1. Click **Start > Control Panel > Network and Sharing Center**.
2. Click **Change Adapter Settings**.
3. Highlight the network adapter you want to use to connect to the device and click **Change settings of this connection**.

The Local Area Connection Properties window for the selected network adapter appears as shown in [Figure 78](#).

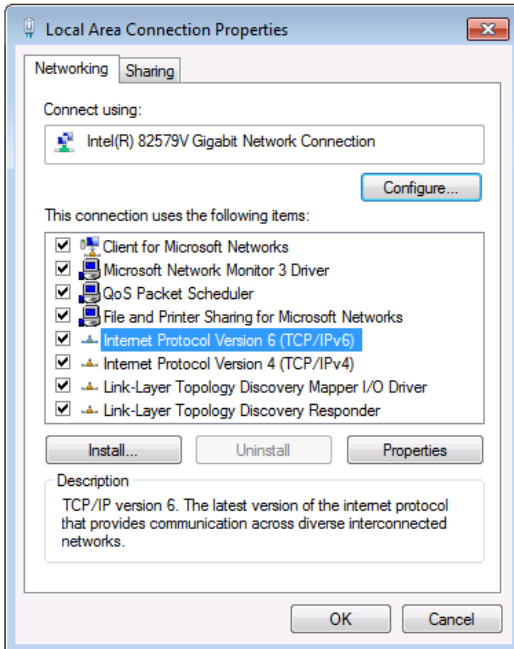

Figure 78: Local Area Connection Properties Window

4. Highlight either **Internet Protocol Version 6 (TCP/IPv6)** or **Internet Protocol Version 4 (TCP/IPv4)** depending on the requirements of your IT system.

5. Click **Properties**.

The Internet Protocol Properties window relevant to your IT system appears as shown in [Figure 79](#) or [Figure 80](#).

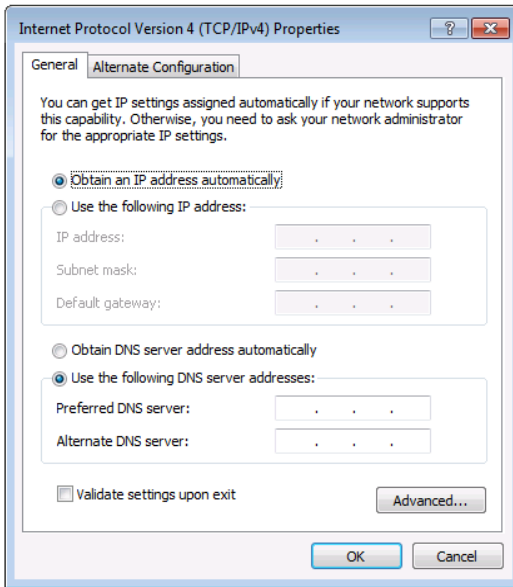

Figure 79: Internet Protocol Version 4 Properties Window

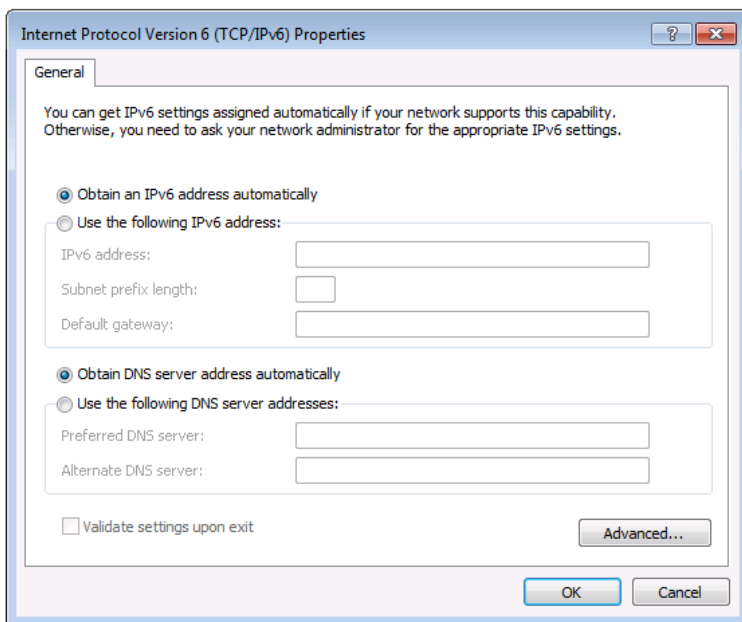

Figure 80: Internet Protocol Version 6 Properties Window

6. Select **Use the following IP Address** for static IP addressing and fill in the details as shown in [Figure 81](#).
For TCP/IPv4 you can use any IP address in the range 192.168.1.1 to 192.168.1.255 (excluding 192.168.1.39) that is provided by your IT department.

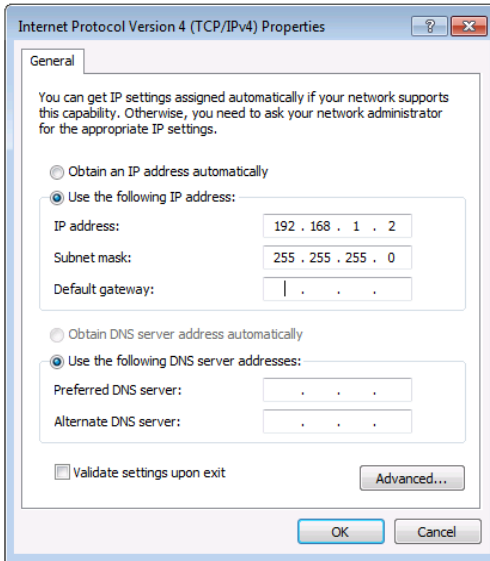

Figure 81: Internet Protocol Properties Window

7. Click **OK**.
8. Click **Close**.

8.2.2 Connecting the Ethernet Port via a Network Hub or Switch

You can connect the Ethernet port of the **VCO-1**, **VCO-8**, **VCO-16** to the Ethernet port on a network hub or using a straight-through cable with RJ-45 connectors.

9 Technical Specifications

Inputs:	VCO-1, VCO-8, VCO-16: 1 HDMI connector (HDMI, HDCP version 1.4), 1 USB port
Outputs:	VCO-1: 1 HDMI connector (HDMI, HDCP version 1.4) VCO-8: 8 HDMI connectors (HDMI, HDCP version 1.4), 1 LOOP HDMI connector VCO-16: 16 HDMI connectors (HDMI, HDCP version 1.4), 1 LOOP HDMI connector
Ports	VCO-1, VCO-8, VCO-16: 1 RJ-45 Ethernet port 10/100BaseT
Bandwidth:	Full HD resolution (1080p60 or 1920x1200)
Controls	IP address setup DIP-switches, Reset/Test button, Ethernet (VCO Setup App), output status indication LEDs, input indication LED, loop indication LED (for VCO-8 and VCO-16 only)
Power Consumption:	VCO-1: 5V DC, 800mA max. VCO-8: 100-240V AC, 32VA max. VCO-16: 100-240V AC, 32VA max.
Operating Temperature:	0° to +40°C (32° to 104°F)
Storage Temperature:	-40° to +70°C (-40° to 158°F)
Humidity:	10% to 90%, RHL non-condensing
Dimensions:	VCO-1: 12cm x 7.1cm x 2.4cm (4.7" x 2.8" x 0.94") W, D, H VCO-8, VCO-16: 19" x 7" x 1U (W, D, H) rack mountable
Shipping Dimensions:	VCO-1: 15.7cm x 12cm x 8.7cm (6.2" x 4.7" x 3.4") W, D, H VCO-8, VCO-16: 55cm x 27.6cm x 10.7cm (21.6" x 10.9" x 4.2") W, D, H
Weight:	VCO-1: 0.25kg (0.55lbs) approx. VCO-8: 1.53kg (3.37lbs) approx. VCO-16: 1.7kg (3.74lbs) approx.
Shipping Weight:	VCO-1: 0.66kg (1.45lbs) approx. VCO-8: 2.42kg (5.3lbs) approx. VCO-16: 2.6kg (5.7lbs) approx.
Included Accessories:	VCO-1: Power supply unit (5V DC, 4A) VCO-8, VCO-16: Power cord, rack ears, cable bracket, cable plastic ties VCO-1: RK-3T 19" rack mount
Specifications are subject to change without notice. For the most updated specifications, go to our Web site at www.kramerav.com	

9.1 Default Communication Parameters

Ethernet	
IP Address:	192.168.1.39
Subnet mask:	255.255.255.0
Default gateway:	192.168.1.254
TCP Port #:	5000
Full Factory Reset	
Reset/Test button	While power is switched on, press and hold the RESET (or TEST) button for at least 5 seconds. Set the DIP-switches to 1 1 1 0 0 1 0 0 positions (DIP#1 to DIP#8, 1=on, 0=off).
Ethernet (TCP/IP) Command Protocol	
Command Format:	ASCII protocol 3000
Example (Stop playback, and remove overlay from the screen for output 1):	#Y 0,150,0,0<CR>

10 Communication Protocol

The **VCO-1**, **VCO-8**, **VCO-16** Video Content Overlay Solution can be operated using the Kramer Protocol 3000 serial commands. The command framing varies according to how you interface with the **VCO-1**, **VCO-8**, **VCO-16**. In the following example, the firmware version number command is entered as follows:

- Terminal communication software, such as Hercules:

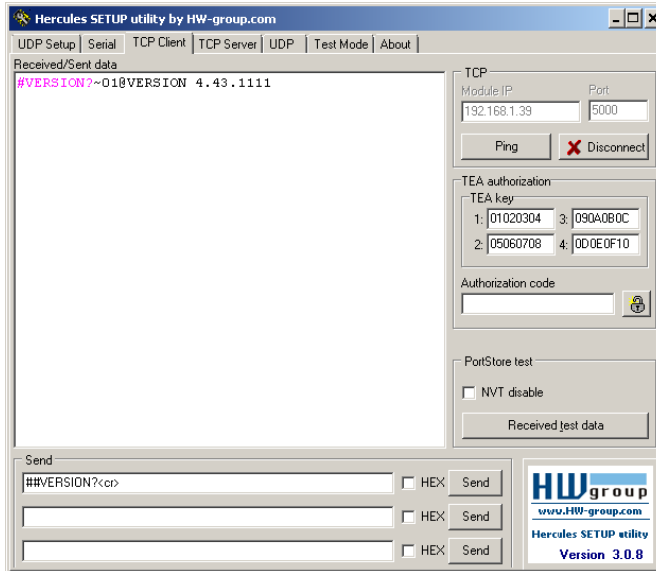

The framing of the command varies according to the terminal communication software. This command is used for demonstration purposes only and its syntax may vary per device.

- K-Touch Builder (Kramer software):



- K-Config (Kramer configuration software):

Command Syntax

Display Command as Hex Decimal ASCII

"#VERSION?";0x0D

Set

Clear



All the examples provided in this section are based on using the Kramer K-Config software.

You can enter commands directly using terminal communication software (e.g., Hercules) by connecting a PC to the Ethernet port on the **VCO-1**, VCO-8, VCO-16. To enter `CR` press the Enter key (`LF` is also sent but is ignored by the command parser).

Commands sent from various non-Kramer controllers (e.g., Crestron) may require special coding for some characters (such as, `/x##`). For more information, refer to your controller's documentation.

For more information about:

- Using Protocol 3000 commands, see [Section 10.1](#)
- General syntax used for Protocol 3000 commands, see [Section 10.2](#)
- Protocol 3000 commands available for the **VCO-1**, VCO-8, VCO-16, see [Section 10.3](#)

10.1 Understanding Protocol 3000

Protocol 3000 commands are structured according to the following:

- **Command** – A sequence of ASCII letters (A-Z, a-z and -). A command and its parameters must be separated by at least one space.
- **Parameters** – A sequence of alphanumeric ASCII characters (0-9, A-Z, a-z and some special characters for specific commands). Parameters are separated by commas.
- **Message string** – Every command entered as part of a message string begins with a message starting character and ends with a message closing character.



A string can contain more than one command. Commands are separated by a pipe (|) character.

The maximum string length is 64 characters.

- **Message starting character:**
 - # – For host command/query
 - ~ – For device response
- **Device address** – K-NET Device ID followed by @ (optional, K-NET only)
- **Query sign** – ? follows some commands to define a query request
- **Message closing character:**
 - `CR` – Carriage return for host messages (ASCII 13)
 - `CR LF` – Carriage return for device messages (ASCII 13) and line-feed (ASCII 10)
- **Command chain separator character** – Multiple commands can be chained in the same string. Each command is delimited by a pipe character (|). When chaining commands, enter the message starting character and the message closing character only at the beginning and end of the string.



Spaces between parameters or command terms are ignored. Commands in the string do not execute until the closing character is entered. A separate response is sent for every command in the chain.

10.2 Kramer Protocol 3000 Syntax

The Kramer Protocol 3000 syntax uses the following delimiters:

- **CR** = Carriage return (ASCII 13 = 0x0D)
- **LF** = Line feed (ASCII 10 = 0x0A)
- **SP** = Space (ASCII 32 = 0x20)

Some commands have short name syntax in addition to long name syntax to enable faster typing. The response is always in long syntax.

The Protocol 3000 syntax is in the following format:

- Host Message Format:

Start	Address (optional)	Body	Delimiter
#	<i>Device_id@</i>	Message	CR

- **Simple Command** – Command string with only one command without addressing:

Start	Body	Delimiter
#	Command SP <i>Parameter_1,Parameter_2,...</i>	CR

- **Command String** – Formal syntax with command concatenation and addressing:

Start	Address	Body	Delimiter
#	<i>Device_id@</i>	Command_1 <i>Parameter1_1,Parameter1_2,...</i> Command_2 <i>Parameter2_1,Parameter2_2,...</i> Command_3 <i>Parameter3_1,Parameter3_2,...</i> ...	CR

- **Device Message Format:**

Start	Address (optional)	Body	Delimiter
~	<i>Device_id@</i>	Message	CR LF

- **Device Long Response** – Echoing command:

Start	Address (optional)	Body	Delimiter
~	<i>Device_id@</i>	Command SP [<i>Param1,Param2 ...</i>] result	CR LF

10.3 Protocol 3000 Commands

This section includes the following commands:

- System commands (see [Section 10.3.1](#))
- Communication commands (see [Section 10.3.2](#))
- Device-specific P3000 commands (see [Section 10.3.3](#))
- Device-specific Y commands (see [Section 10.3.4](#))

10.3.1 System Commands

Command	Description
#	Protocol handshaking (system mandatory)
BUILD-DATE	Get device build date (system mandatory)
FACTORY	Reset to factory default configuration
HELP	Get command list (system mandatory)
MODEL	Get device model (system mandatory)
NAME	Get machine (DNS) name
NAME-RST	Reset machine (DNS) name to factory default
PROT-VER	Get device protocol version (system mandatory)
SN	Get device serial number (system mandatory)
VERSION	Get device firmware version (system mandatory)
RESET	Reset device (system mandatory)

10.3.1.1

Functions		Permission	Transparency
Set:	#	End User	Public
Get:	-	-	-
Description		Syntax	
Set:	Protocol handshaking	# <code>CR</code>	
Get:	-	-	
Response			
~nn@SEOk <code>CR</code> LF			
Notes			
Validates the Protocol 3000 connection and gets the machine number Step-in master products use this command to identify the availability of a device			
K-Config Example			
"#" , 0x0D			

10.3.1.1 BUILD-DATE

Functions		Permission	Transparency
Set:	BUILD-DATE	End User	-
Get:	-	-	-
Description		Syntax	
Set:			
Get:	get device build date	# BUILD-DATE? CR	
Response			
~ nn @ BUILD-DATE SP date SE time CR LF			
Parameters			
date – Format: YYYY/MM/DD where YYYY = Year, MM = Month, DD = Day			
time – Format: hh:mm:ss where hh = hours, mm = minutes, ss = seconds			
K-Config Example			
Read the device build date: "# BUILD-DATE? ",0x0D			

10.3.1.1 FACTORY

Functions		Permission	Transparency
Set:	FACTORY	End User	Public
Get:	-	-	-
Description		Syntax	
Set:	Reset device to factory defaults configuration	# FACTORY CR	
Get:	-	-	
Response			
~ nn @ FACTORY SP OK CR LF			
Notes			
This command deletes all user data from the device. The deletion can take some time. Your device may require powering off and powering on for the changes to take effect.			
K-Config Example			
Reset the device to its factory default configuration: "# FACTORY ",0x0D			

10.3.1.2 MODEL

Functions		Permission	Transparency
Set:	-	-	-
Get:	MODEL?	End User	Public
Description		Syntax	
Set:	-	-	
Get:	Get device model	#MODEL? CR	
Response			
-nn@MODEL\$Pmodel_nameCR LF			
Parameters			
model_name – String of up to 19 printable ASCII chars			
Notes			
This command identifies equipment connected to Step-in master products and notifies of identity changes to the connected equipment. The Matrix saves this data in memory to answer REMOTE-INFO requests			
K-Config Example			
Get device model: "#MODEL?" , 0x0D			

10.3.1.3 NAME

Functions		Permission	Transparency
Set:	NAME	Administrator	Public
Get:	NAME?	End User	Public
Description		Syntax	
Set:	Set machine (DNS) name	#NAME\$Pmachine_nameCR	
Get:	Get machine (DNS) name	#NAME? CR	
Response			
Set: -nn@NAME\$Pmachine_nameCR LF			
Get: -nn@NAME?\$Pmachine_nameCR LF			
Parameters			
machine_name – String of up to 15 alpha-numeric chars (can include hyphen, not at the beginning or end) the device will automatically add 6 last Hex digits of its MAC address to this name.			
Notes			
The machine name is not the same as the model name. The machine name is used to identify a specific machine or a network in use (with DNS feature on).			
K-Config Example			
Get device name: "#NAME?" , 0x0D			

10.3.1.4 NAME-RST

Functions		Permission	Transparency
Set:	-	Administrator	Public
Get:	NAME-RST	-	-
Description		Syntax	
Set:	Reset machine (DNS) name to factory default	#NAME-RST <code>CR</code>	
Get:			
Response			
~ <code>nn</code> @NAME-RST <code>SP</code> OK <code>CR LF</code>			
Notes			
Factory default of machine (DNS) name is "KRAMER_" + 4 last digits of device serial number.			
K-Config Example			
Reset device name: "#NAME-RST", 0x0D			

10.3.1.5 PROT-VER

Functions		Permission	Transparency
Set:	-	-	-
Get:	PROT-VER?	End User	Public
Description		Syntax	
Set:	-	-	
Get:	Get protocol version	#PROT-VER? <code>CR</code>	
Response			
~ <code>nn</code> @PROT-VER <code>SP</code> 3000:version <code>CR LF</code>			
Parameters			
Version – Format: XX.XX where X is a decimal digit			
K-Config Example			
Get the protocol version: "#PROT-VER?", 0x0D			

10.3.1.6 SN

Functions		Permission	Transparency
Set:	-	-	-
Get:	SN?	End User	Public
Description		Syntax	
Set:	-	-	
Get:	Get device serial number	#SN? <input type="checkbox"/>	
Response			
~nn@SN ^{SP} serial_number ^{CR LF}			
Parameters			
serial_number – 14 decimal digits, factory assigned			
K-Config Example			
Get device serial number: "#SN?", 0x0D			

10.3.1.7 VERSION

Functions		Permission	Transparency
Set:	-	-	-
Get:	VERSION?	End User	Public
Description		Syntax	
Set:	-	-	
Get:	Get version number	#VERSION? <input type="checkbox"/>	
Response			
~nn@VERSION ^{SP} firmware_version ^{CR LF}			
Parameters			
firmware_version – Format: XX.XX.XXXX where the digits group are: major.minor.build version			
K-Config Example			
Get the firmware version number: "#VERSION?", 0x0D			

10.3.1.8 RESET

Functions		Permission	Transparency
Set:	RESET	Administrator	Public
Get:	-	-	-
Description		Syntax	
Set:	Reset device	#RESET <input type="checkbox"/>	
Get:	-	-	
Response			
~nn@RESET ^{SP} OK ^{CR LF}			
K-Config Example			
Reset the device: "#RESET?", 0x0D			

10.3.2 Communication Commands

Command	Description
ETH-PORT	Get Ethernet port protocol
NET-MAC	Get MAC address
NET-IP	Set/get IP address
NET-GATE	Set/get gateway IP
NET-MASK	Set/get subnet mask

10.3.2.1 ETH-PORT

Functions	Permission	Transparency
Set: ETH-PORT	Administrator	Public
Get: ETH-PORT?	End User	Public
Description	Syntax	
Set: Set Ethernet port protocol	#ETH-PORT ^{SP} portType, ETHPort ^{CR}	
Get: Get Ethernet port protocol	#ETH-PORT? ^{SP} portType ^{CR}	
Response		
~nn@ETH-PORT ^{SP} portType, ETHPort ^{CR LF}		
Parameters		
portType – TCP/UDP		
ETHPort - TCP/UDP port number		
K-Config Example		
Set the Ethernet port type and number address: "#ETH-PORT TCP,5000",0x0D		

10.3.2.2 NET-MAC

Functions	Permission	Transparency
Set: -	-	-
Get: NET-MAC?	End User	Communication
Description	Syntax	
Set:		
Get: Get MAC address	#NET-MAC? ^{CR}	
Response		
~nn@NET-MAC ^{SP} mac_address ^{CR LF}		
Parameters		
mac_address – Unique MAC address. Format: XX-XX-XX-XX-XX-XX where X is hex digit.		
K-Config Example		
Get the MAC address: "#NET-MAC? XX-XX-XX-XX-XX-XX",0x0D		

10.3.2.3 NET IP

Functions		Permission	Transparency
Set:	NET-IP	Administrator	-
Get:	NET-IP?	End User	Communication
Description		Syntax	
Set:	Set device IP address	#NET-IP SP P1 CR	
Get:	Get device IP address	#NET-IP? CR	
Response			
Set:	~nn@NET-IP SP ip_address SP OK CRLF		
Get:	~nn@NET-IP SP ip_address CR LF		
Parameters			
P1 – IP address, in the following format: xxx.xxxx.xxxx.xxxx (since the last xxx number is set by the DIP-switches, it is ignored in this command)			
Notes			
For proper settings consult your network administrator.			
K-Config Example			
Set the IP address to 192.168.1.39: "#NET-IP 192.168.001.039",0x0D			

10.3.2.4 NET-GATE

Functions		Permission	Transparency
Set:	NET-GATE	Administrator	-
Get:	NET-GATE?	End User	Communication
Description		Syntax	
Set:	Set Gateway IP	#NET-GATE SP P1 CR	
Get:	Get Gateway IP	#NET-GATE? CR	
Response			
Set:	~nn@NET-GATE SP P1 SP OK CR LF		
Get:	~nn@NET-GATE SP ip_address CR LF		
Parameters			
P1 – gateway IP address, in the following format:			
Notes			
A network gateway connects the device via another network and maybe over the Internet. Be careful of security problems. For proper settings consult your network administrator			
K-Config Example			
Set the gateway IP address to 192.168.0.1: "#NET-GATE 192.168.000.001",0x0D			

10.3.2.5 NET-MASK

Functions		Permission	Transparency
Set:	NET-MASK	Administrator	-
Get:	NET-MASK?	End User	Communication
Description		Syntax	
Set:	Set device subnet mask	#NET-MASK _{SP} net_mask _{CR}	
Get:	Get device subnet mask	#NET-MASK? _{CR}	
Response			
Set:	~ _{nn} @NET-MASK _{SP} P1 _{SP} OK _{CR LF}		
Get:	~ _{nn} @NET-MASK _{SP} net_mask _{CR LF}		
Parameters			
P1 – net-mask format: xxx.xxx.xxx.xxx			
Response triggers			
The subnet mask limits the Ethernet connection within the local network. For proper settings consult your network administrator.			
K-Config Example			
Set the subnet mask to 255.255.0.0: "#NET-MASK 255.255.000.000",0x0D			

10.3.3 Device Specific Command

Command	Description
MON-TYPE	Get EDID information from the display

10.3.3.1 MON-TYPE

Functions		Permission	Transparency
Set:		-	-
Get:	MON_TYPE?	End User	Public
Description		Syntax	
Set:			
Get:	Get EDID information from the display	#MON_TYPE? _{SP} out _{CR}	
Response			
~ _{nn} @MON_TYPE _{SP} EDID_STRING _{CR LF}			
Parameters			
out – output number (counts from 0). For VCO-1 always equals to 0; for VCO-8 (0 to 7) and VCO-16 (0 to 15). EDID_STRING – the EDID information read from the monitor currently connected to the required output. If no monitor is connected, <i>EDID_STRING</i> is empty.			
K-Config Example			
Read EDID of the Display connected to output 3 "#MON_TYPE? 2",0x0D			

10.3.4 Device-Specific “Y” Commands

Syntax for a “set” command (write value to the device):

```
#Y 0,function,value,parameter<CR>
```

Device response:

```
#Y 0,function,value,parameter<CR>
```

Syntax for a “get” command (read value from the device):

```
#Y 1,function,parameter<CR>
```

Device response:

```
#Y 1,function,value,parameter<CR>
```

Parameter means input or output number of the device. All devices have only 1 input (that means in the INPUT case the Parameter always equals to 0). Depending on the device model (which may have different number of outputs) the allowed range of OUTPUT parameter is specified in brackets []. For instance, for [8] the allowed parameter is 0 to 7 (eight possible outputs, counted from 0).

Description	Function #	Parameter	Value	Notes
HDMI input HDCP capability	105	INPUT[1]	0	HDMI input is HDCP compliant
			1	HDMI input is not HDCP compliant Additional parameter defines HDMI Input 0 only.
Playback control	150	VCO-1: OUTPUT[1] VCO-8: OUTPUT[8] VCO-16: OUTPUT[16]	0	Stop playback, and remove overlay from the screen
			1	Start (or restart) playback from the start of the playback program
			2	Resume playback from the last paused position, or from the start
			3	Pause playback, showing overlay statically, at its last shown frame (freeze)
Read Playback Position (Read only)	151	VCO-1: OUTPUT[1] VCO-8: OUTPUT[8] VCO-16: OUTPUT[16]	[0:32765]	Current playback program position (at the moment the command was received)

Description	Function #	Parameter	Value	Notes
Limit playback, lower bound	152	VCO-1: OUTPUT[1] VCO-8: OUTPUT[8] VCO-16: OUTPUT[16]	[0:32765]	Playback program will start from this position (default=0)
Limit playback, upper bound	153	VCO-1: OUTPUT[1] VCO-8: OUTPUT[8] VCO-16: OUTPUT[16]	[0:32765]	Playback program will end with this position (default=32765), and cycle back to start
Input resolution (Read only)	301	INPUT[1]	[0:56]	See Section 10.3.4.1
Test Signal STATUS (Read only)	334	VCO-1: OUTPUT[1] VCO-8: OUTPUT[8] VCO-16: OUTPUT[16]	0	No test signal; normal mode
			1	Test signal is on
Display Connected STATUS (Read only)	340	VCO-1: OUTPUT[1] VCO-8: OUTPUT[8] VCO-16: OUTPUT[16]	0	No display connected to output
			1	Display is connected
Common STATUS (Read only)	341	VCO-1: OUTPUT[1] VCO-8: OUTPUT[8] VCO-16: OUTPUT[16]	[0:15]	Bitwise status information. Use AND mask to extract data: mask=1: background input signal status (0=signal is present; 1=none) mask=2: output test signal status (0=test is present; 2=none, normal mode) mask=4: display connected status (0=no display; 4=display is connected)

10.3.4.1 Input Resolution (Function 301)

Value	Notes	Value	Notes
0	480i/60 INP_RSL[4] - background	29	1024x768/60
1	576i/50	30	1024x768/70
2	720p/50	31	1024x768/75
3	720p/59	32	1024x768/85
4	720p/60	33	1152x864/75
5	1080i/50	34	1280x768/60 reduced blanking
6	1080i/59	35	1280x768/60
7	1080i/60	36	1280x768/75
8	1080p/23	37	1280x800/60
9	1080p/24	38	1280x960/60
10	1080p/25	39	1280x960/85
11	1080p/29	40	1280x1024/60
12	1080p/30	41	1280x1024/75
13	1080p/50	42	1360x768/60
14	1080p/59	43	1366x768/60
15	1080p/60	44	1400x1050/60 reduced blanking

Value	Notes	Value	Notes
16	1080sf/23	45	1400x1050/60
17	1080sf/24	46	1400x1050/75
18	1080sf/25	47	1440x900/60 reduced blanking
19	1080sf/29	48	1440x900/60 reduced blanking
20	1080sf/30	49	1440x900/75
21	640x480/60	50	1440x900/85
22	640x480/72	51	1600x1200/60
23	640x480/75	52	1680x1050/60 reduced blanking
24	640x480/85	53	1680x1050/60
25	800x600/60	54	1920x1200/60 reduced blanking
26	800x600/72	55	UNIDENTIFIED INPUT SIGNAL
27	800x600/75	56	NO INPUT SIGNAL
28	800x600/85		

LIMITED WARRANTY

The warranty obligations of Kramer Electronics for this product are limited to the terms set forth below:

What is Covered

This limited warranty covers defects in materials and workmanship in this product.

What is Not Covered

This limited warranty does not cover any damage, deterioration or malfunction resulting from any alteration, modification, improper or unreasonable use or maintenance, misuse, abuse, accident, neglect, exposure to excess moisture, fire, improper packing and shipping (such claims must be presented to the carrier), lightning, power surges, or other acts of nature. This limited warranty does not cover any damage, deterioration or malfunction resulting from the installation or removal of this product from any installation, any unauthorized tampering with this product, any repairs attempted by anyone unauthorized by Kramer Electronics to make such repairs, or any other cause which does not relate directly to a defect in materials and/or workmanship of this product. This limited warranty does not cover cartons, equipment enclosures, cables or accessories used in conjunction with this product.

Without limiting any other exclusion herein, Kramer Electronics does not warrant that the product covered hereby, including, without limitation, the technology and/or integrated circuit(s) included in the product, will not become obsolete or that such items are or will remain compatible with any other product or technology with which the product may be used.

How Long Does this Coverage Last

Seven years as of this printing; please check our Web site for the most current and accurate warranty information.

Who is Covered

Only the original purchaser of this product is covered under this limited warranty. This limited warranty is not transferable to subsequent purchasers or owners of this product.

What Kramer Electronics will do

Kramer Electronics will, at its sole option, provide one of the following three remedies to whatever extent it shall deem necessary to satisfy a proper claim under this limited warranty:

1. Elect to repair or facilitate the repair of any defective parts within a reasonable period of time, free of any charge for the necessary parts and labor to complete the repair and restore this product to its proper operating condition. Kramer Electronics will also pay the shipping costs necessary to return this product once the repair is complete.
2. Replace this product with a direct replacement or with a similar product deemed by Kramer Electronics to perform substantially the same function as the original product.
3. Issue a refund of the original purchase price less depreciation to be determined based on the age of the product at the time remedy is sought under this limited warranty.

What Kramer Electronics will not do Under This Limited Warranty

If this product is returned to Kramer Electronics or the authorized dealer from which it was purchased or any other party authorized to repair Kramer Electronics products, this product must be insured during shipment, with the insurance and shipping charges prepaid by you. If this product is returned uninsured, you assume all risks of loss or damage during shipment. Kramer Electronics will not be responsible for any costs related to the removal or re-installation of this product from or into any installation. Kramer Electronics will not be responsible for any costs related to any setting up this product, any adjustment of user controls or any programming required for a specific installation of this product.

How to Obtain a Remedy under this Limited Warranty

To obtain a remedy under this limited warranty, you must contact either the authorized Kramer Electronics reseller from whom you purchased this product or the Kramer Electronics office nearest you. For a list of authorized Kramer Electronics resellers and/or Kramer Electronics authorized service providers, please visit our web site at www.kramerelectronics.com or contact the Kramer Electronics office nearest you.

In order to pursue any remedy under this limited warranty, you must possess an original, dated receipt as proof of purchase from an authorized Kramer Electronics reseller. If this product is returned under this limited warranty, a return authorization number, obtained from Kramer Electronics, will be required. You may also be directed to an authorized reseller or a person authorized by Kramer Electronics to repair the product.

If it is decided that this product should be returned directly to Kramer Electronics, this product should be properly packed, preferably in the original carton, for shipping. Cartons not bearing a return authorization number will be refused.

Limitation on Liability

THE MAXIMUM LIABILITY OF KRAMER ELECTRONICS UNDER THIS LIMITED WARRANTY SHALL NOT EXCEED THE ACTUAL PURCHASE PRICE PAID FOR THE PRODUCT. TO THE MAXIMUM EXTENT PERMITTED BY LAW, KRAMER ELECTRONICS IS NOT RESPONSIBLE FOR DIRECT, SPECIAL, INCIDENTAL OR CONSEQUENTIAL DAMAGES RESULTING FROM ANY BREACH OF WARRANTY OR CONDITION, OR UNDER ANY OTHER LEGAL THEORY. Some countries, districts or states do not allow the exclusion or limitation of relief, special, incidental, consequential or indirect damages, or the limitation of liability to specified amounts, so the above limitations or exclusions may not apply to you.

Exclusive Remedy

TO THE MAXIMUM EXTENT PERMITTED BY LAW, THIS LIMITED WARRANTY AND THE REMEDIES SET FORTH ABOVE ARE EXCLUSIVE AND IN LIEU OF ALL OTHER WARRANTIES, REMEDIES AND CONDITIONS, WHETHER ORAL OR WRITTEN, EXPRESS OR IMPLIED. TO THE MAXIMUM EXTENT PERMITTED BY LAW, KRAMER ELECTRONICS SPECIFICALLY DISCLAIMS ANY AND ALL IMPLIED WARRANTIES, INCLUDING, WITHOUT LIMITATION, WARRANTIES OF MERCHANTABILITY AND FITNESS FOR A PARTICULAR PURPOSE. IF KRAMER ELECTRONICS CANNOT LAWFULLY DISCLAIM OR EXCLUDE IMPLIED WARRANTIES UNDER APPLICABLE LAW, THEN ALL IMPLIED WARRANTIES COVERING THIS PRODUCT, INCLUDING WARRANTIES OF MERCHANTABILITY AND FITNESS FOR A PARTICULAR PURPOSE, SHALL APPLY TO THIS PRODUCT AS PROVIDED UNDER APPLICABLE LAW.

IF ANY PRODUCT TO WHICH THIS LIMITED WARRANTY APPLIES IS A "CONSUMER PRODUCT" UNDER THE MAGNUSON-MOSS WARRANTY ACT (15 U.S.C.A. §2301, ET SEQ.) OR OTHER APPLICABLE LAW, THE FOREGOING DISCLAIMER OF IMPLIED WARRANTIES SHALL NOT APPLY TO YOU, AND ALL IMPLIED WARRANTIES ON THIS PRODUCT, INCLUDING WARRANTIES OF MERCHANTABILITY AND FITNESS FOR THE PARTICULAR PURPOSE, SHALL APPLY AS PROVIDED UNDER APPLICABLE LAW.

Other Conditions

This limited warranty gives you specific legal rights, and you may have other rights which vary from country to country or state to state.

This limited warranty is void if (i) the label bearing the serial number of this product has been removed or defaced, (ii) the product is not distributed by Kramer Electronics or (iii) this product is not purchased from an authorized Kramer Electronics reseller. If you are unsure whether a reseller is an authorized Kramer Electronics reseller, please visit our Web site at www.kramerelectronics.com or contact a Kramer Electronics office from the list at the end of this document.

Your rights under this limited warranty are not diminished if you do not complete and return the product registration form or complete and submit the online product registration form. Kramer Electronics thanks you for purchasing a Kramer Electronics product. We hope it will give you years of satisfaction.

KRAMER



P/N: 2900-300592



Rev: 1



SAFETY WARNING

Disconnect the unit from the power supply before opening and servicing

For the latest information on our products and a list of Kramer distributors, visit our Web site where updates to this user manual may be found.

We welcome your questions, comments, and feedback.

www.kramerAV.com
info@kramerele.com