



User's Manual

DU8190Z



Table of Contents

Copyright	3
Copyright	3
Disclaimer	3
About the Manual	3
Important Safety Guidelines	4
Safety Notification	4
Installation and Use Notices	6
Disposal of Old Electric and Electronic Equipment	6
Important Recycling Instructions	6
Introduction	7
Packing Checklist	7
Projector Overview	8
IO Panel	10
Control Panel	11
Installation and Setting up	14
Inserting or Changing the Remote Control Batteries	14
Installing the projector	15
Precautions for Installation	15
Mounting the projector	16
Installing or Removing the Optional Lens	17
Selecting the Input Voltage of AC Power	19
Connecting to AC Power Supply	19
Turning on the Projector	19
Turning off the Projector	20
Setting up the installation condition	21
Setting up the Projection Mode	21
Adjusting Projected Image Position	22
Adjusting the Focus and Zoom	22
Preventing the Unauthorized Use of the Projector	23
Using the Control Panel Lock	23
Using Security Lock	24
Using Control ID for Multi-projector Application	26
Making Connections	28
Connecting to Personal Computer	28
Connecting to the Video Device	28
Connecting to the Control Equipment	28
Connecting to the Screen Trigger	30
Connecting to external HDBaseT Transmitter	31
Using the projector	32
Using On-Screen Display	32
Using the OSD Menu	32
Menu Tree	33
OSD Menu – INPUT	36
OSD Menu – PICTURE	39
OSG Menu – ALIGNMENT	40
OSD Menu – CONTROL	43
OSD Menu – SERVICE	46
Product Specification	47

Supported Signal Input Timing	48
Configurations of Terminals	51
DU8190Z Lens Series	52
Product Dimensions	53
LED Indication	54
Common Problems and Solutions	55
About the Vivitek Support	57

Copyright

Copyright

The User's Manual (including all pictures, illustrations and software) is protected by the international copyright right law. All rights are reserved. No duplication of the manual or any content included in the manual is allowed without the written consent of the manufacturer.

Vivitek is the trademark of Vivitek Corporation. ©All rights reserved. 2017

Disclaimer

The information in the manual is subject to change without notice. The manufacturer does not provide any statement or warranty of the contents in the manual and clearly give up the implied warranties of merchantability and of fitness for a particular purpose. The manufacturer reserves the rights to modify the publication and change the contents of the materials at any time without notice to any person.

About the Manual

The manual describes how to install and use the projector and is applicable to the end-user. Relevant information (such as illustrations and descriptions) is put on the same page as possible as we can. The format, easy for printing, is convenient for reading and paper-saving which is beneficial to environmental protection. It is suggested printing the page you need.

Important Safety Guidelines

Thank you for purchasing the high quality product!

Read the Manual carefully to obtain the best performance. The Manual provides instructions to use the menu and implement operation.

Safety Notification

CAUTION To turn off main power, ensure to unplug from power outlet.



CAUTION To prevent electric shock, do not open the cabinet. There are high-voltage components inside. Refer service to qualified service personnel.



CAUTION The symbol warns the user about electric shock caused by voltage not insulated. Therefore, it is dangerous to make any kind of contact with any parts of inside units.



CAUTION To prevent the projector from electrical discharge or electric shock, do not expose the projector to rain or moist environment. Do not use the plug with an extension cord or an outlet unless all the prongs can be fully inserted.



This symbol alerts the user that important information which should be read carefully to avoid problems concerning the operation and maintenance.

WARNING TO CALIFORNIA RESIDENTS:

Handling the cables supplied with this equipment might expose user to a little lead, a chemical known to the State of California, resulting in risks of barrenness. Please remember to wash hands after handling.

NOTIFICATION (CANADA)

This Class A digital equipment complies with Canadian ICES-003.

CE NOTIFICATION

This is a Class A product, which complies with rules for CE marking. This product may cause radio interference that the user may be supposed to take adequate measures.

FCC NOTIFICATION

This device complies with part 15 of the FCC Rules. Operation is subject to the following two conditions:

- (1) This device may not cause harmful interference;
 - (2) This device must accept any interference received, including interference that may cause undesired operation.
- This equipment has been tested and found to comply with part 15 of the FCC Rules. These requirements are designed to provide reasonable protection against harmful interference when the equipment operates in a commercial environment. This equipment might generate radio frequency energy. If user does not install or use in accordance with the instructions in manual, the radio frequency energy may interfere radio reception. If the above scenario occurs, the user may be responsible to correcting the interference



WARNING!

Changes or modifications without approval from Vivitek could void the user's authorization to operate the product.

LIGHT MODULE

- A light module containing multiple laser diodes acts as the light source in the product.
- These laser diodes are sealed in the light module. It is recommended to ask dealer for maintenance or repair services of the light module.
- End user is not allowed to replace the light module.
- Contact distributor who provides the qualified service for light module replacement and further information.

LASER SAFETY NOTIFICATION AND CAUTION



Do not stare at the lens while in use

- CLASS 3R LASER PRODUCT
- This Laser Product is designated as Class 3R during all procedures of operation.
- LASER LIGHT - AVOID DIRECT EYE EXPOSURE.
- Do not point laser or allow reflected laser light toward other people or reflective objects.
- Direct or scattered light can be hazardous to eyes and skin.
- There is a potential hazard of eye exposure to laser radiation if the included instructions are not followed.
- Caution – use of controls, adjustments or performance of procedures other than those specified herein may result in hazardous radiation exposure.

Laser Parameters:

Wavelength	: 450nm - 460nm	Total internal power	: >100W
Mode of operation	: Pulsed, due to frame rate	Apparent source size	: >10mm, at lens stop
Pulse width	: 0.74ms	Divergence	: >100 mili Radian
Maximum laser energy	: 0.253mJ		

Product Label

Manufacturer's ID Label, Explanatory Label and Certification Statement Label



Hazard Warning Symbol and Aperture Label



Installation and Use Notices

1. Read and keep this manual properly.
2. Pay attention to all the noted warnings, and follow all the guidelines and descriptions in this manual.
3. Do not use the projector near water.
4. Do not install the equipment near the thermal sources, such as heaters, radiators, furnace, amplifiers, and any other equipment that may generate heat.
5. Be careful while holding the equipment or moving the trolley with projector to prevent the equipment from turning over.
6. Notice whether there is any parts with flaws after receiving the projector.
7. Please notice that the projector will not power on until the lens is fitted. The protection covering the lens should be taken to install the lens.
8. Do not let any vent be obstructed.
9. Do not destroy the safety protection function of polarized or grounding plug of power cord. A polarized plug has one wide and one narrow blade. The plug has two blades and one grounding blade. The wide blade or grounding blade is provided for the safety concerns. If the plug provided does not match the outlet, please contact the electrician to change outlet.
10. The +12V trigger only outputs 12V DC trigger signal. Do not connect other power input or output. Otherwise, the equipment may malfunction.
11. Adjust the slide switch with suitable volt input, and then plug in the projector; the red LED indicator would flash and then stabilize, getting into standby mode. User should only use the connectors or accessories provided by the manufacturer.
12. When user turns on the projector, the red LED indicator would flash until stabilize. Do not look at the lens directly while the projector is running.
13. Unplug the power cord of the equipment if there is a thunderstorm or the equipment is not going to be used for a long time.
14. The packaging materials can be kept properly for transportation use afterwards.
15. If any breakdown occurs, please contact dealer or manufacture for qualified repair service.



Disposal of Old Electric and Electronic Equipment

The symbol on your product or the package represents that the product should not be treated as the normal household waste when discarded but should be carried to the recycling location of the waste electric and electronic equipment. The consequence on the environment and human health due to the incorrect disposal of the product can be prevented if it can be ensured that the product is properly discarded. Material recycling is helpful to the protection of natural resources. The symbol is only valid in European Union. If you want to discard electrical and electronic equipment, contact the governmental authorities or your dealer for the correct method of disposal.

Important Recycling Instructions

The product may contain other electronic wastes and may pose risk if not discarded properly. Abide by the local, state/provincial or federal laws of recycling or discarding. For more information, please visit the website and contact Electronic Industries Alliance (EIA) on WWW.EIAE.ORG.

Introduction

The User's Manual describes the installation, setup and operation of the DU8190Z projector and provides assistance to the installation personnel and the end-user to fully develop the performance of the projector. VIVITEK has made every effort to ensure that the information in the Manual is correct at the time of printing. The contents may be frequently updated due to the continuously product improvement and customer feedback.

You can find the latest version of the Manual and the manual of other Vivitek products on www.vivitekcorp.com.

Packing Checklist

The following items are included in the packaging box of the DU8190Z series projector. If any loss or damage to any item, contact your dealer or Vivitek customer service department.

AC Power Cord



VGA Signal Cable

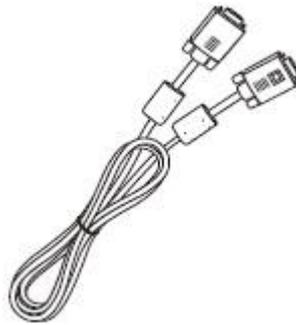

Wired Remote Cable



IR Remote Control



Anti-theft Screw (M4)
(for Lens Installation)

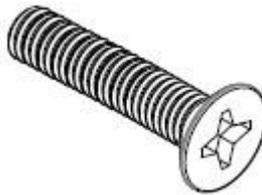

User's Manual Disc



RoHS Card (China)

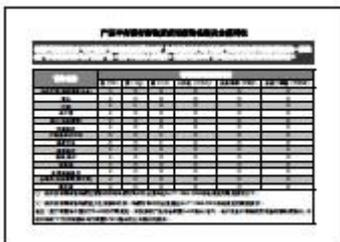

Certificate (China)



Projector Overview

Front-right View

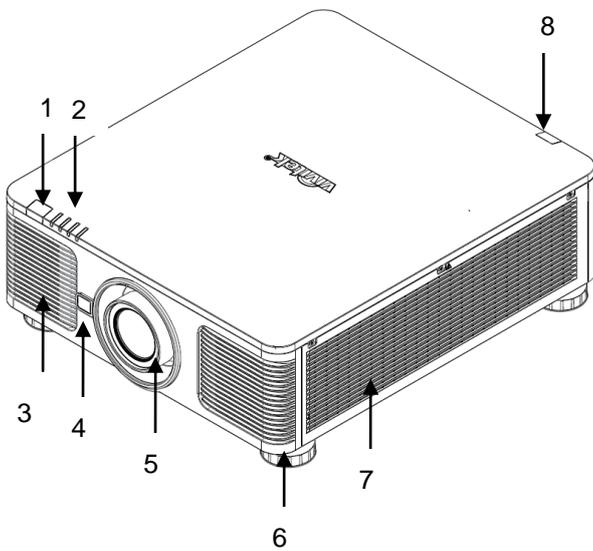

1. **Front IR Receiver**
The Receiver for IR signals from remote control.
2. **LED Indicator**
Display current projector status such as power, light source status and warning.
3. **Air Intake**
The fan pulls the cool air to the projector for system cooling.
4. **Lens Release Button**
Press the Lens Release button before removing the lens.
5. **Lens hood**
Remove the cover before installing the lens.
6. **Height Adjuster**
Adjust level of projector
7. **Intake Vent**
The fans pull air to cool the radiator of the projector.
8. **Rear IR Receiver**
The Receiver for IR signals from remote control.

Rear-right View

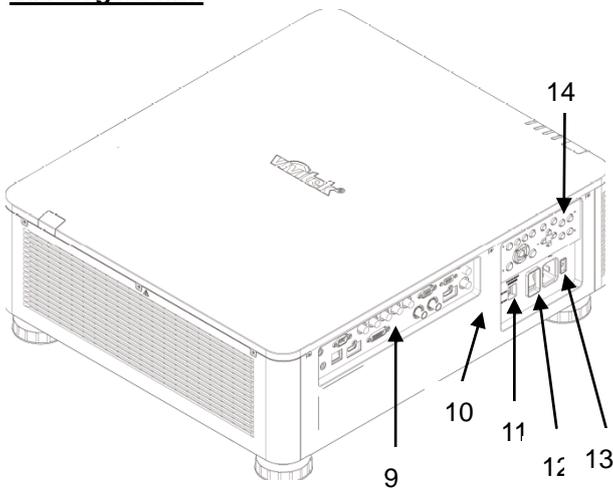

9. **I/O Connector Panel**
Connect to various input, control or output terminals to the projector.
10. **Kensington Lock**
Attach the projector to a permanent object with the Kensington slot and a security cable.
11. **Slide Switch**
Switch it to corresponding input voltage
12. **AC Power Switch**
Turn on/off the AC power of the projector.
13. **AC Inlet**
Connect the supplied power cable to this inlet.
14. **Control Panel**
Press the button to operate the OSD menu or adjust the lens Settings see OSD controls.

Important:

The air passes through grill openings on the projector is for good air circulation. Do not obstruct any of the grill openings and keep the required distance from any object.

Bottom View

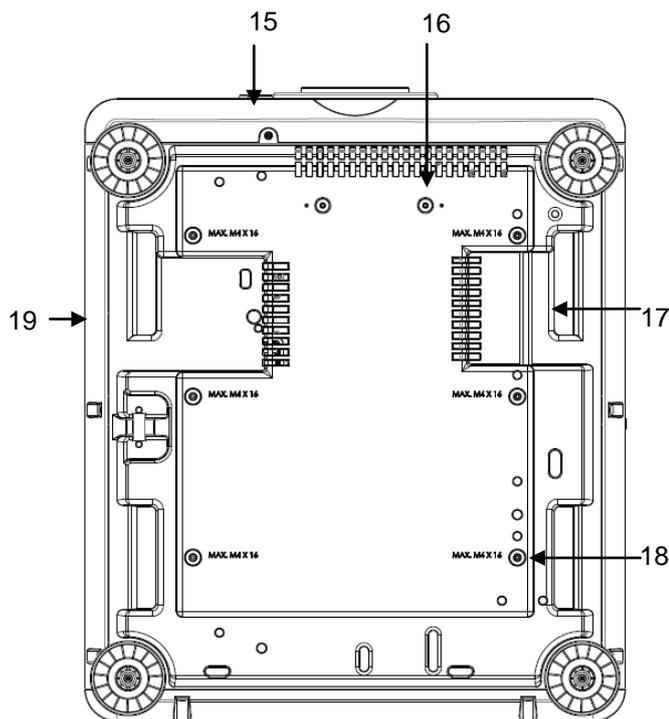

15. Anti-thief Screw hole

The anti-thief screw can be fastened to prevent Lens removing by unauthorized person.

16. Mounting Holes of Support Kit

These two screws holes can be used to fix support kits of ultra-short throw lens.

Note: The screws are for Lens support kits only; overloading may damage the projector or cause injury.

17. Recess for projector handling.

These four recesses can be used for handling the projector.

18. Ceiling Mounting Hole

Total, 6 holes for M4 screw, maximum depth 14mm.

19. Security Slot

The slot can be used for Short-term protection

Note:

- When installing, ensure that you use only UL Listed ceiling mounts, Contact your dealer for information on mounting the projector on a ceiling.
- With ceiling installation, use approved mounting hardware & M4 screws; maximum depth of screw: 14 mm.

IO Panel

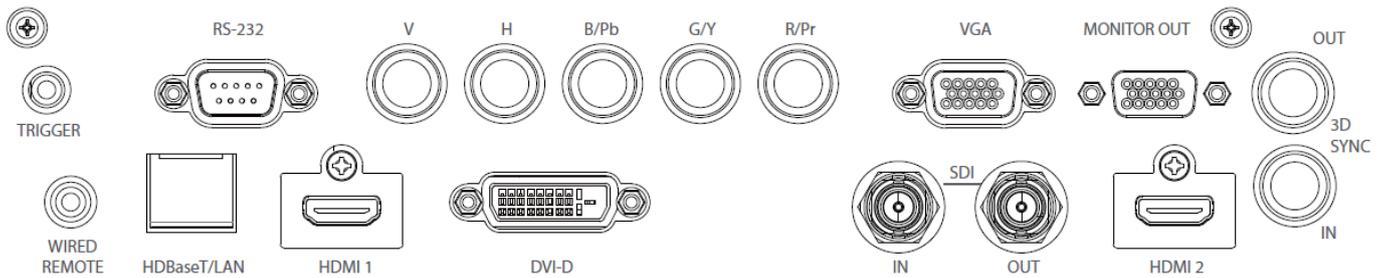

TRIGGER(12V +/-1.5V)

When connected to the screen through a 3.5mm cable, the screen deploys automatically on startup of the projector. The screen reacts when the projector is powered off.

RS-232

The 9-pin D-sub interface is used to connect to the PC control system and projector maintenance.

Component (V, H, B/Pb, G/Y, R/Pr)

Connect RGBHV or Component signal from computer or component video enabled device

VGA

Provide the standard 15-pin VGA connection and can connect to RGB, HD Component or personal computer.

MONITOR OUT

Connect to a monitor to display the projected content.

WIRED REMOTE

Connect the supplied remote controller to the projector

HDBaseT/LAN

Connect an Ethernet cable (Cat5/Cat6, not supplied) from a computer, network device, or HDBaseT transmitter.

HDMI 1

Connect the HDMI cable from a computer or video device

DVI-D

Connect to DVI-D cable from a DVI-D output of the device.

SDI IN/OUT

Connect to SDI source.

HDMI 2

Connect the HDMI cable from a computer or video device

3D SYNC IN / Out

Connect to the 3D IR synchronization signal transmitter.

Note for Trigger

- When the projector is turned on, a control signal (DC 12V) outputs from this terminal.
- Do not use this jack for anything other than intended use.

Note for Wired Remote

- Please make sure whether the port for insertion is correct before the terminal of the wired remote control is inserted. The remote control may be damaged if inserted to the wrong port such as trigger. Do not use this jack for anything other than intended use.

Control Panel

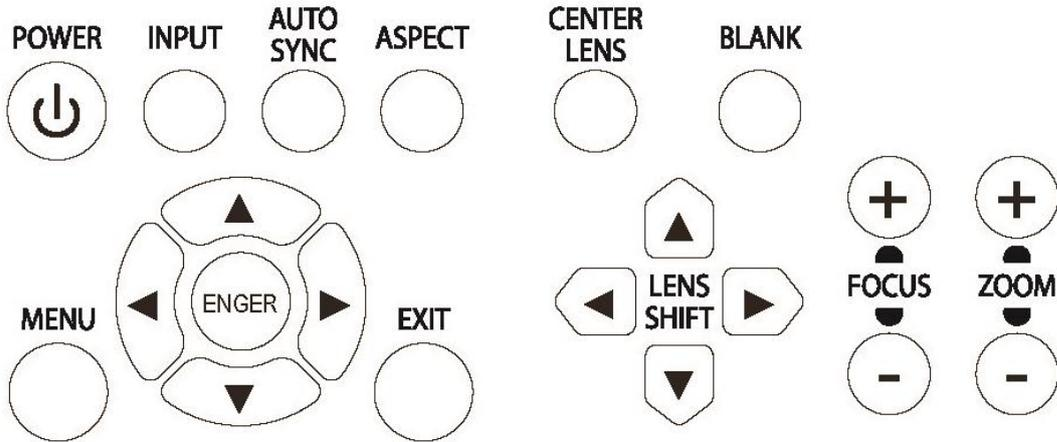

POWER

User the button to turn on/off the projector.

INPUT

Push the button to select the input signal. HDMI, DVI, VGA, Component...etc.

AUTO SYNC

Implement automatic signal synchronization.

ASPECT

Change the aspect ratio of the current image and push the button to change to the next aspect ratio settings.

MENU

Push the button to display or hide the OSD menu.

UP/Down/Left/Right

Use the button to select the OSD option.

ENTER

Use the button to select settings or confirm the changed settings.

EXIT

Push the button to return to the menu on the previous level or exit the OSD menu.

CENTER LENS

Push the button to center the lens and calibrate the parameter of lens shift, focusing and zooming.

Note: The lens memory function requires the accurate lens adjustment parameter. Please center the lens every time after the lens is mounted.

Blank

Use the button to stop the projection temporarily

LENS SHIFT

Use these four buttons to move the projected image to desired position.

FOCUS

Use the button to adjust the focus of projected image.

ZOOM

Use the button to zoom in/out the projected image.

Remote Control

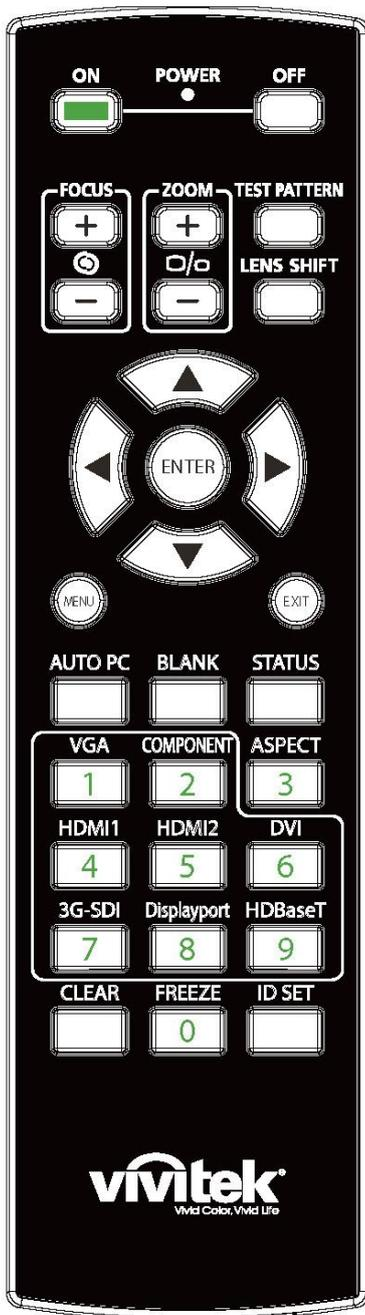

Wired Remote Jack

Connect to WIRED REMOTE terminal on the projector

On
Use the button to turn on the projector.

OFF
Use the button to turn off the projector.

FOCUS
Adjust the focus of the projected image.

ZOOM
Zoom in/out the projected image.

TEST PATTERN
Use the button to show the test pattern. Press this button again to switch to the next pattern. Press the EXIT button to return to the projected image.

LENS SHIFT
Use the button to move the lens right or left.

ENTER
Use the button to select settings or confirm the changed settings.

MENU
Press the button to display or hide the OSD Menu.

EXIT
Press the button to return to the previous Menu or exit the OSD Menu.

AUTO PC
You can use this function to execute signal source auto synchronization

BLANK
Press the button to temporarily interrupt the projection.

STATUS
Show OSD MENU – SERVICE.

VGA
Select VGA input source.

COMPONENT
Select Component input source.

ASPECT
Press the button to display aspect ratio options.

HDMI1
Select HDMI 1 input source.

HDMI2
Select HDMI 2 input source.

DVI
Select DVI input source.

3G-SDI
Select 3G-SDI input source.

DisplayPort (Not available for this model)

HDBaseT
Select HDBaseT input source.

CLEAR
Erase the set ID number of the remote control; refer to the section “Using Control ID for Multi-projector Application” on page 26.

FREEZE
Freeze the projected image or resume the projection.

ID SET
Set up ID number for remote control; refer to the section “Using Control ID for Multi-projector Application” on page 26.

Remote Control Operating Range

The remote control uses infrared transmission to control the projector. It is not necessary to point the remote directly at the projector. Provided you are not holding the remote perpendicular to the sides or the rear of the projector, the remote will function well within a radius of about 10 meters (25 feet) and 15 degrees above or below the projector level. If the projector does not respond to the remote control, move a little closer.

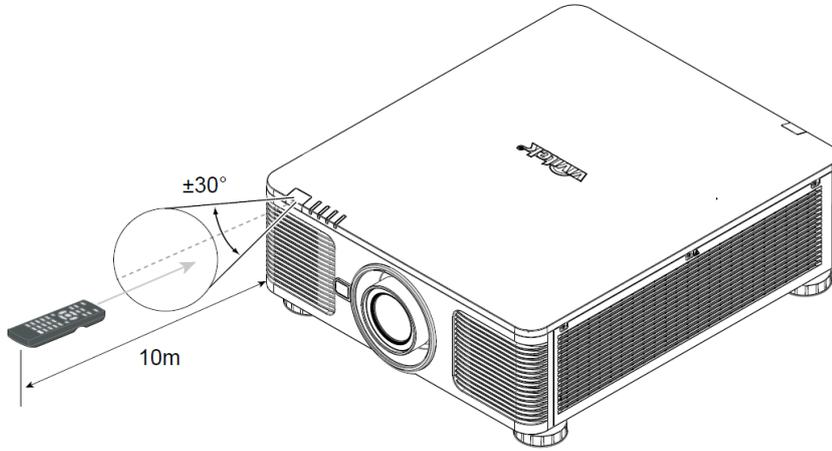

Installation and Setting up

Inserting or Changing the Remote Control Batteries

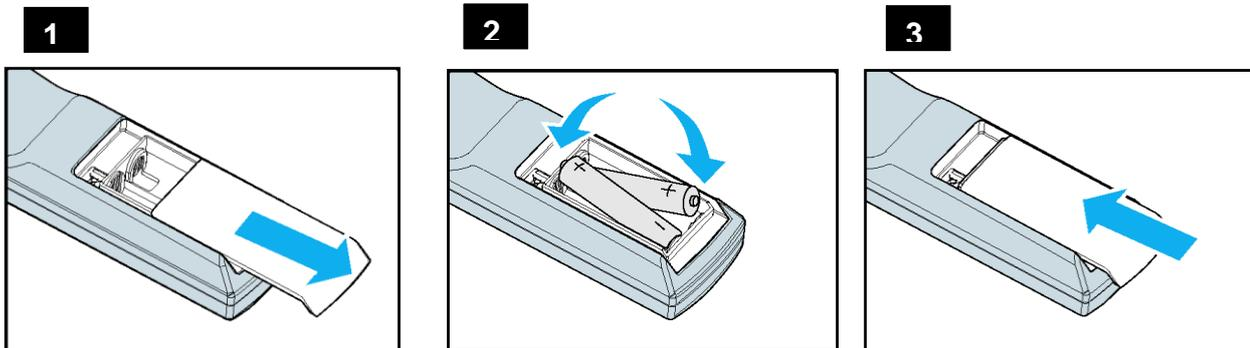

1. Remove the battery compartment cover by sliding the cover in the direction of the arrow.
2. Place two AA batteries with the correct polarity.
3. Slide on the cover as the arrow in the illustration.

Important:

- Avoid using the projector with bright fluorescent lighting turned on. Certain high-frequency fluorescent lights can disrupt remote control operation.
- Be sure nothing obstructs the path between the remote control and the projector.
- Do not expose the remote control to high temperature or humidity; otherwise, the remote control will not work functionally.

Battery installation instructions

- Make sure the battery is installed with the correct polarity
- Do not use the old and new batteries or the batteries of different types together
- Remove the battery if the remote control may not be used for a long time to prevent the damage caused by leaks.

Installing the projector

The high quality display effect can be guaranteed only when the projector is correctly installed. Generally, the light source facing the screen should be reduced or eliminated as much as possible. The contrast of the image will be obviously reduced if the light directly shines on the screen, such as the beam from windows or the searchlight cast on the image. The image may become faded and not bright.

Precautions for Installation

Caution:

- Projector installation must be done by a qualified professional. Contact your dealer for more information. It is not recommended you install the projector yourself.
- With ceiling installation, use approved mounting hardware & M4 screws; maximum depth of screw: 14 mm. Contact your dealer for information about mounting the projector on a ceiling.
- Only use the projector on a solid, level surface, serious injury and damage can occur if the projector is dropped.

Caution:

- Ensure that the hot air from the exhaust vent is not sucked into the projector.
- Ensure the air intake and exhaust vents are unobstructed and keep the required distance from any object. Below is required minimum distance between the vent and any object.
- All added enclosures should pass a certified thermal evaluation to ensure that the projector does not recycle exhaust air, as this may cause the projector to shut down even if the enclosure temperature is within the acceptable operation temperature range.

Airflow and Heat Emission

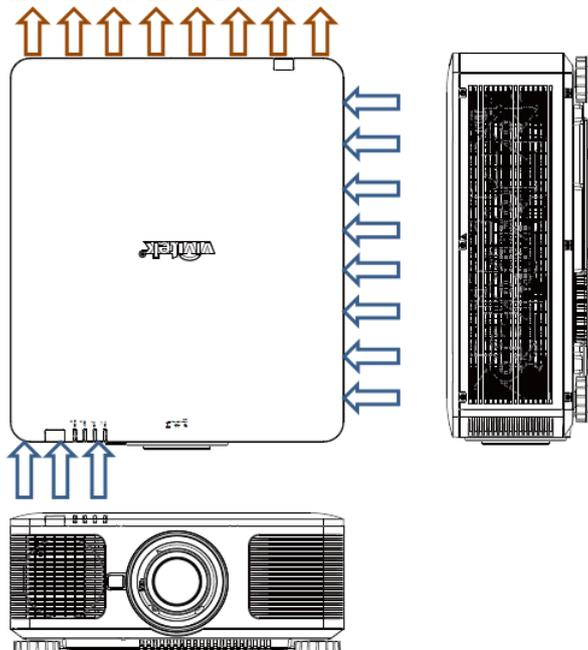

Minimum Distance to Vent

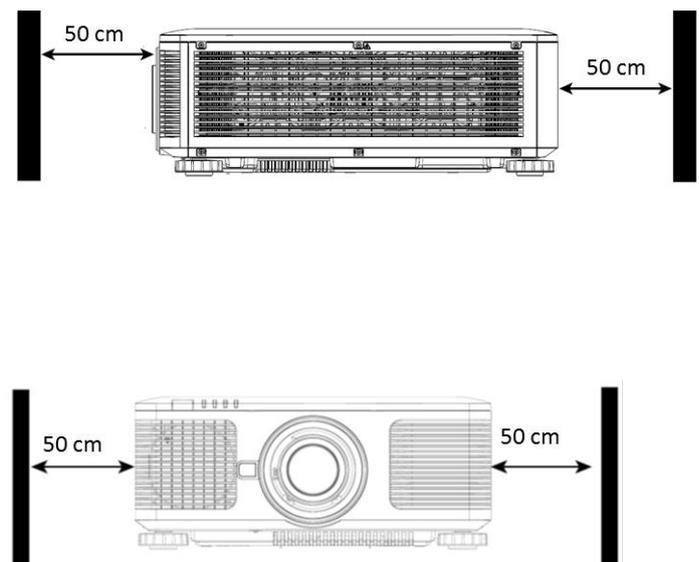

Caution:

- Only use the projector on a solid, level surface, serious injury and damage can occur if the projector is dropped.
- Please do not stack the projector on the surface of another projector, serious injury and damage may occur if the projector is dropped.

Mounting the projector

For mounting the projector, please use UL Listed ceiling mounts and M4 screws, maximum depth of screw: 14 mm.

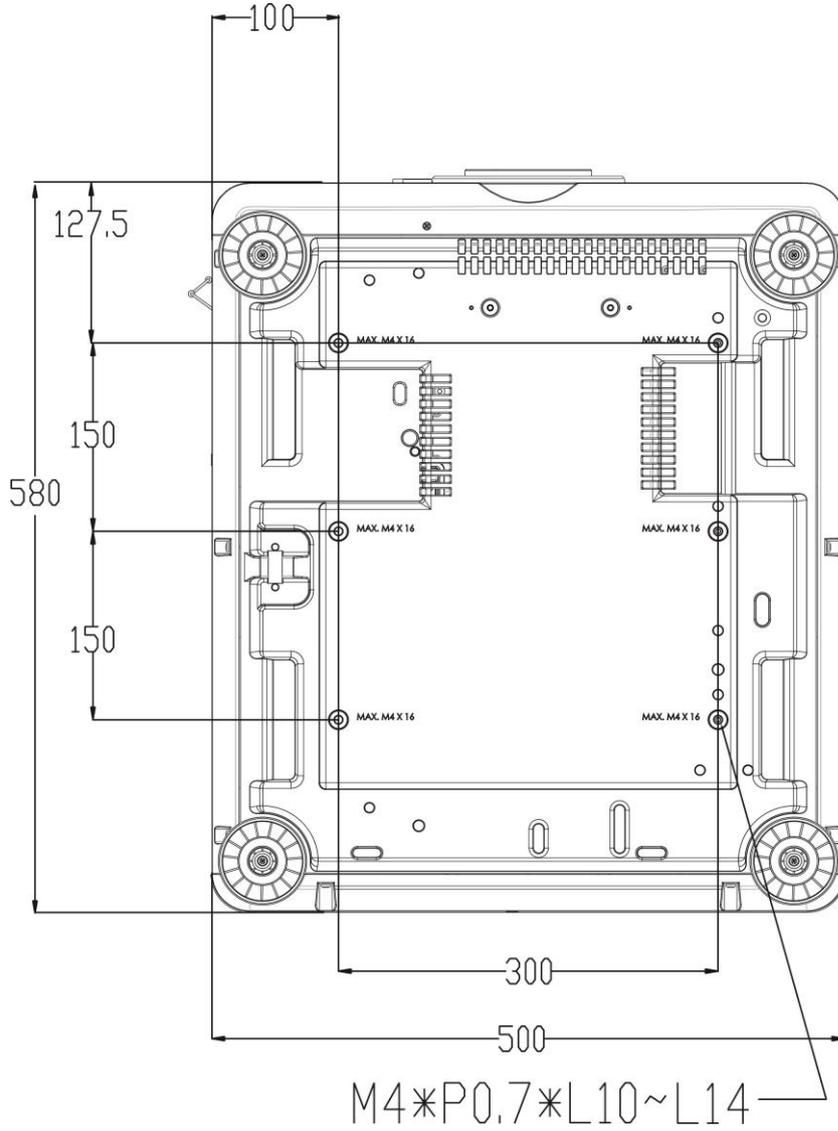

Installing or Removing the Optional Lens

Caution:

- Do not shake or place excessive pressure on the projector or the lens components as the projector and lens components contain precision parts.
- When shipping the projector with the optional lens, remove the optional lens before shipping the projector. The lens and the lens shift mechanism may encounter damage caused by improper handling during transportation.
- Before removing or installing the lens, be sure to turn off the projector and wait till the cooling fans stop, and turn off the main power switch.
- Do not touch the lens surface when removing or installing the lens.
- Keep fingerprints, dust or oil off the lens surface. Do not scratch the lens surface.
- Work on a level surface with a soft cloth under it to avoid scratching.
- If you remove and store the lens, attach the lens cap to the projector to keep off dust and dirt.

Install New Lens

1. If the Lens cover is installed, pull the edge of the lens cover with one hand (①), so that the lens cover can be removed easily with the other hand (②)

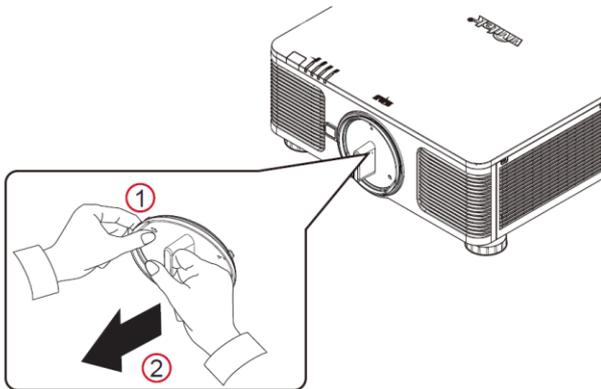

2. Align the "↑" symbol on the lens label with the "*" symbol on the top of the body (align to the center of the lens hole) and pull in the lens.

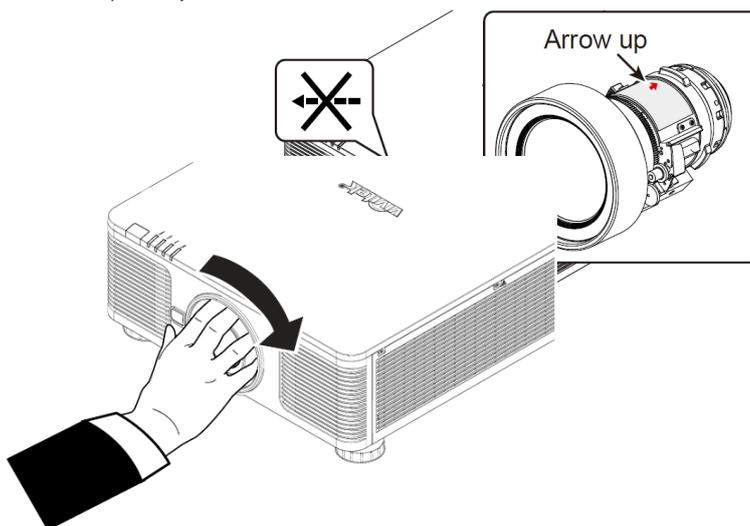

3. Make sure the lens is pushed into the holder and turn it clockwise to the "Lock" position. When turning the lens, the "Click" sounds twice to indicate that the lens is completely fixed.
4. Check if the lens is fixed successfully by pulling the lens out of the holder gently.

Removing the Existing Lens

1. Push the LENS RELEASE button all the way in and rotate the lens counterclockwise. The existing lens will be disengaged

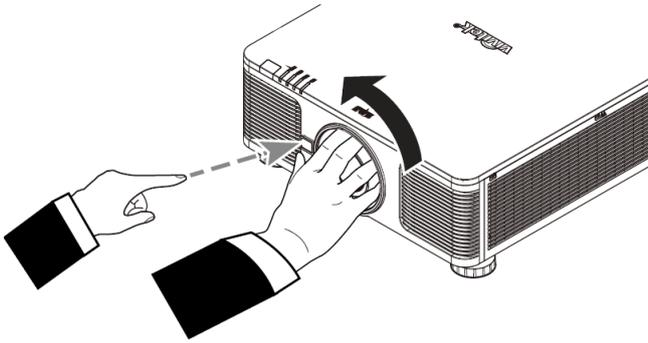

2. Pull out the existing lens slowly.

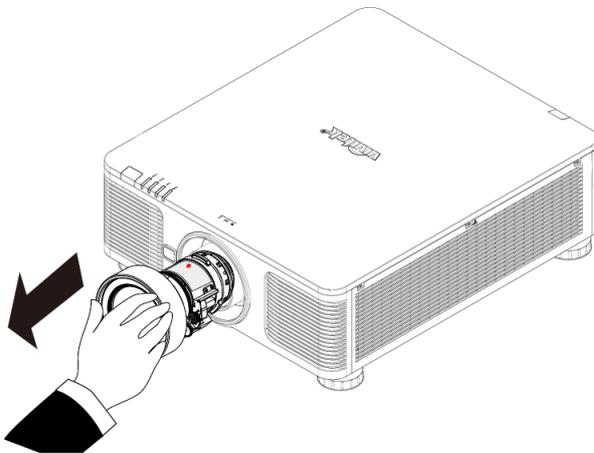

Caution:

- When installing the lens into the projector, be sure to remove the lens cap from the back of the optional lens before installing the optional lens into the projector. Failure to do so will cause damage to the projector and lens.
- There is one safety switch inside the lens slot on the projector to prevent unexpected injury by laser beam, the projector cannot be turned on if the projection lens has not been installed or is not installed correctly. Please make sure the lens is installed properly before tuning on the projector.

Selecting the Input Voltage of AC Power

There is one slide switch near AC switch, please switch it to corresponding input voltage of AC power. Please switch it to 115V if the input voltage range is 100V to 130V, switch to 230V if input voltage range is 200V to 240V.

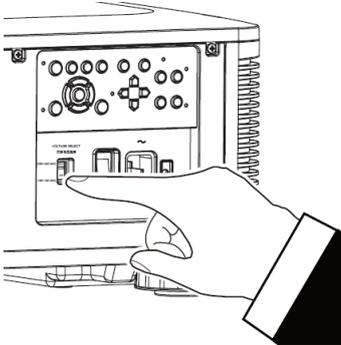

Connecting to AC Power Supply

The AC power cord is included in the box; plug the power cord to the AC socket on the IO panel.

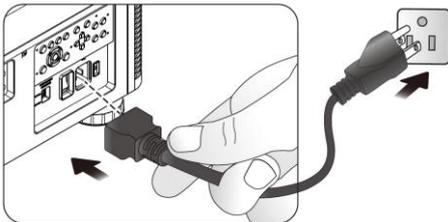

Turning on the Projector

Once the projector is correctly located and the power cable and other connections are in place, it is important that the projector is powered on correctly in order to avoid damage to components and un-necessary wear and tear. Refer to the following guide to power on the projector.

1. Press the main power switch to the on (I) position as shown. POWER LEDs flashes then lights red.

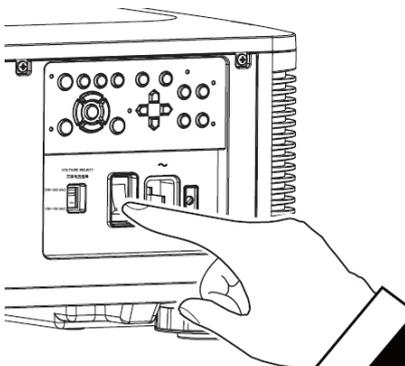

2. Press the POWER button on the control panel or ON button on the remote control.

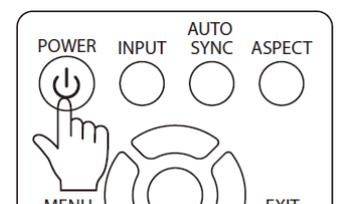
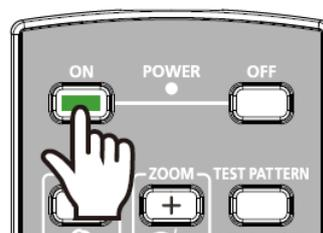

- The Power LED and LIGHT LED flashes green till power on process is finished.

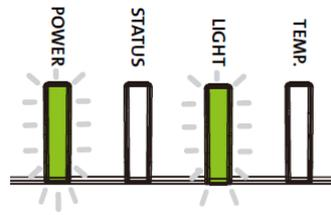

- After few seconds, both LEDs keep green, the projector is ready for use.

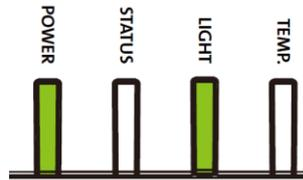

Turning off the Projector

Once the projector is no longer required, it is important to shut it down correctly to avoid damage or unnecessary wear and tear to the projector.

Note:

- Do not unplug the power cable from the wall outlet or projector when the projector is powered on. Doing so can cause damage to the AC IN connector of the project or the prong plug of the power cable. To turn off the AC power supply when the projector is powered on, use a power strip equipped with a switch and a breaker.
- Do not turn off the AC power supply within 10 seconds after making adjustment or changing the setting. Doing so is possible to cause loss of adjustments and settings and return to default.

Refer to the following guide to shut down the projector.

- Press the POWER button on the control panel or OFF button on the remote control once, the Power Off window displays.

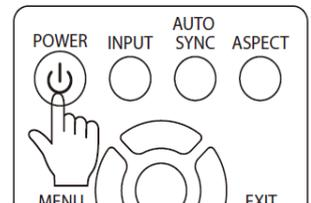
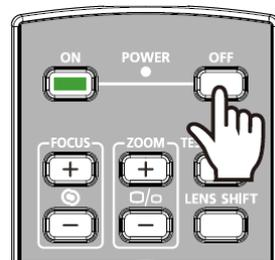

- Press the POWER button again on the OSD control panel or remote control to verify power off, the power LED flashes orange after Power Off is confirmed.

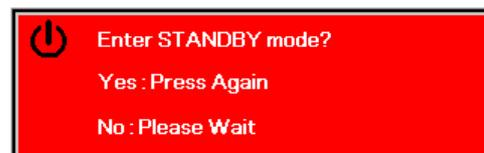

- The projector enters Standby mode when the power LED lights red.
- Press the Main Power switch to the off position (O) to turn off the projector.

Setting up the installation condition

DU8190Z is designed for set up in all angle including desktop, ceiling, portrait and free-tilt installation as below illustration. Please set the cooling condition according to the projector installation as below.

Desktop: Install the projector on the table for front projection or rear projection.

Ceiling: Mount the projection on the ceiling for front projection or rear projection

Free-tilt: Install the projector at an angle, the angle is over $\pm 60^\circ$

Portrait: Install the projector at an angle 90° to project the portrait image.

Auto: The projector is equipped with orientation sensor; projector switches the cooling condition by detected projector orientation.

Desktop, Ceiling and Free-tilt Installation

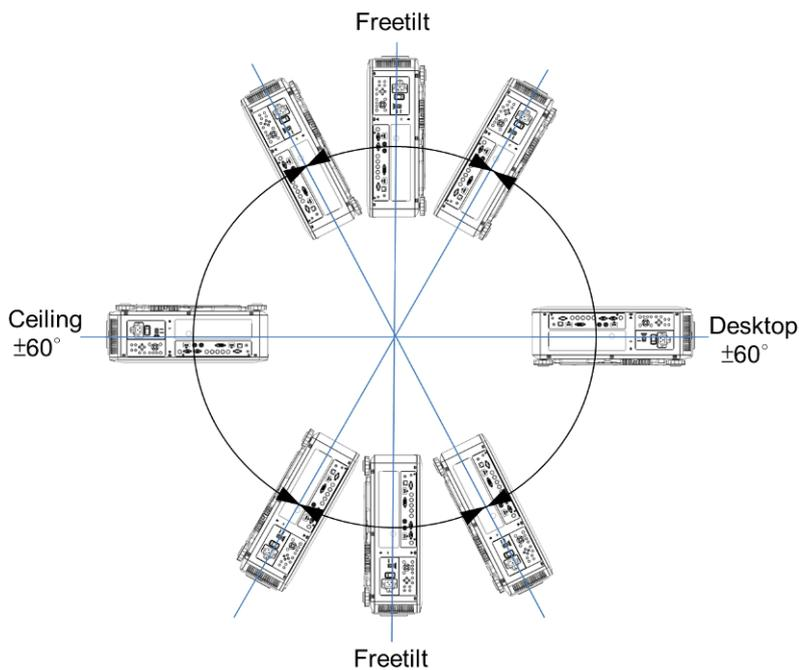

Portrait Installation



Setting up the Projection Mode

The projection mode option can be used to change the orientation of the projected image or flip the projected image.

Front Desktop: Install the projector on the table and project the image on the screen forward.

Front Ceiling: Mount the projector on the ceiling and project the image on the screen forward, the image is overturned.

Rear Desktop: Install the projector on the table and project the image from the rear of the screen.

Rear Ceiling: Mount the projector on the ceiling and project the image from the rear of the screen, the image is overturned.

Adjusting Projected Image Position

The DU8190Z projector has the powered lens shift feature; the image can be shifted vertically or horizontally without moving the projector. The lens shift range is shown in the percentage of the screen height and width, the maximum vertical shift range can be up to 64% of the projected image height and down to 33% of the height, and maximum horizontal shift range is 24% of the image width to right, 14% of the image width to the left. Please refer to below illustration.

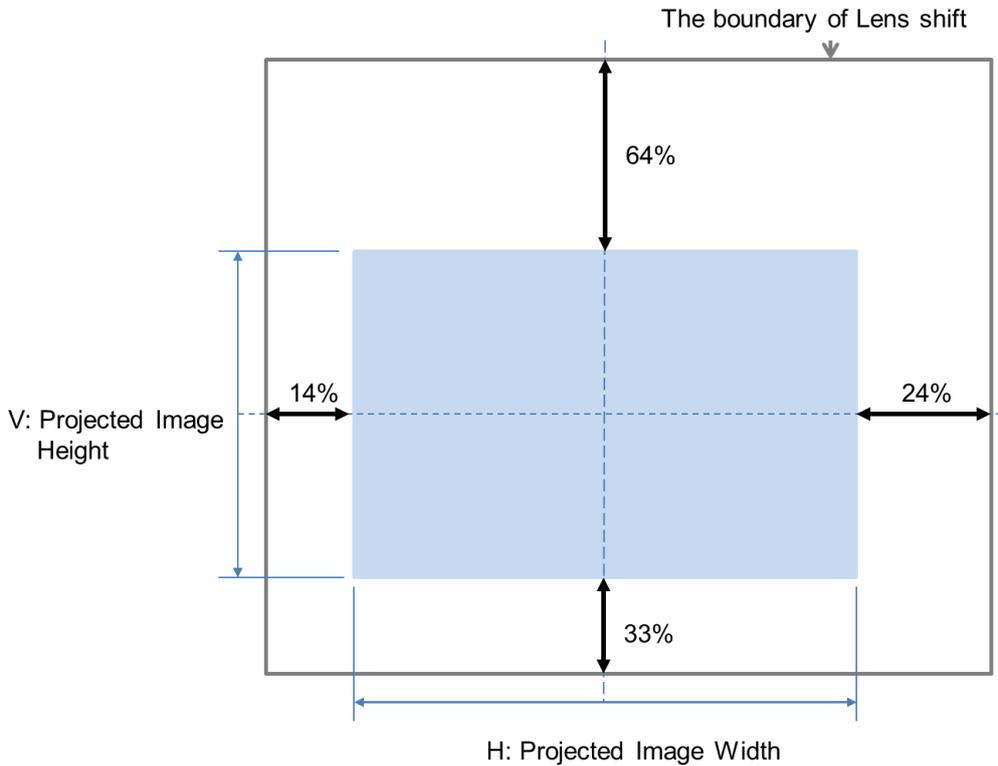

Note:

- The projector is equipped with safety switch inside the lens mount hole; the projection lens must be installed in the projector before turning on the power. Or the projection can't be started.
- There is a Lens Lock function on OSD menu to disable lens control adjustment for avoiding possible misoperation after you finish the adjustment, please make sure to disable the lock before performing the lens control.

Adjusting the Focus and Zoom

The focus and zoom can be adjusted from the projector control panel or remote control. Refer to the following guides to adjust the focus and zoom manually.

Press the Focus or Zoom button on the control key panel or remote control to adjust the focus or zoom effect using the increase and decrease buttons as required

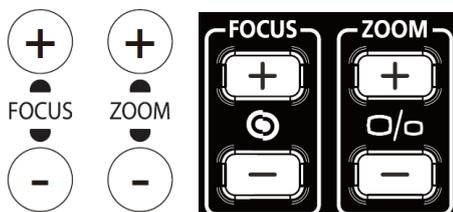

Preventing the Unauthorized Use of the Projector

Using the Control Panel Lock

This function allows you to lock control panel on the projector for preventing the unauthorized operation on control button.

Locking the control buttons

Select CONTROL>OSDSettings>Control Panel Lock to enable the function as below illustration.

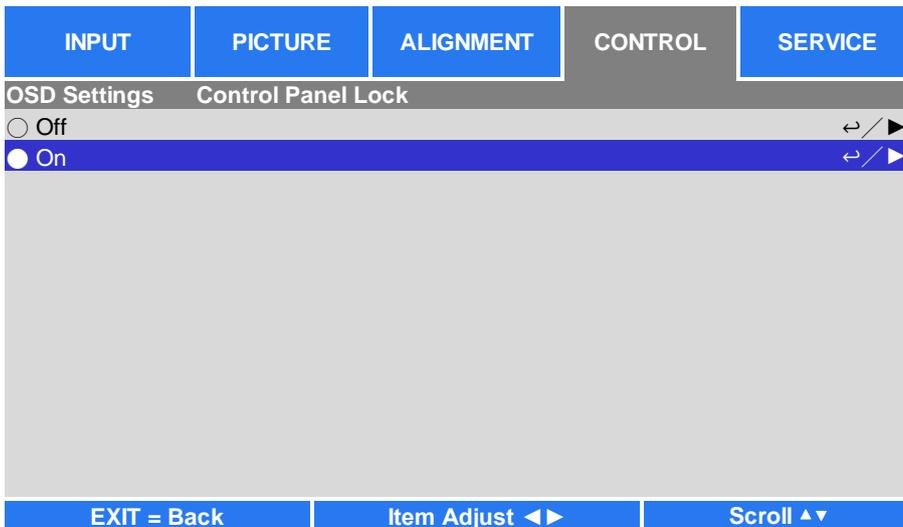
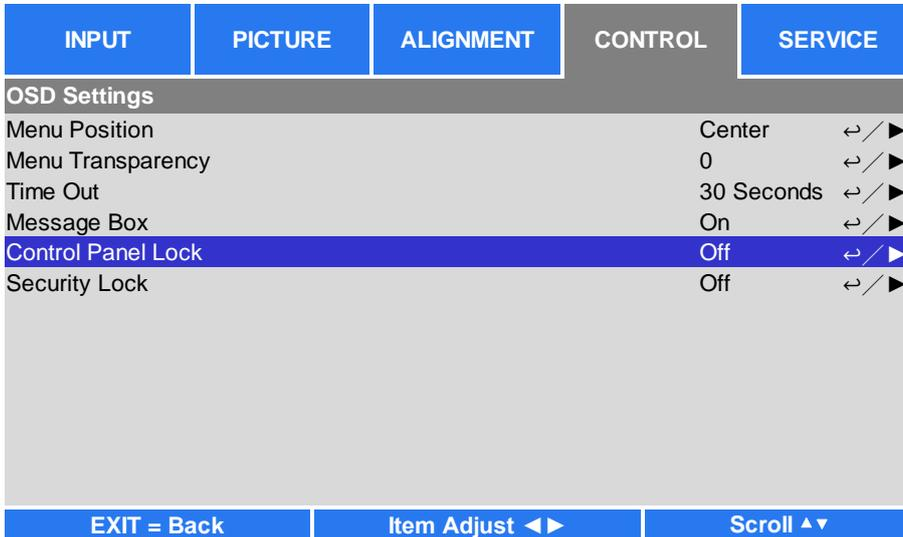

The pop-up message will be shown as below if Control Panel Lock is turned on, select OK to confirm or Cancel to ignore the setting.



Once Control Panel Lock is enabled, all of control buttons on the projector are locked. Below message is shown on the screen few seconds if any control buttons is pressed.



Unlocking the control panel

Once Control Panel Lock is enabled, all of control buttons on the projector are disabled. Please enter the OSD option CONTROL>OSDSetsings>Control Panel Lock then select Off to unlock the control panel by remote control.

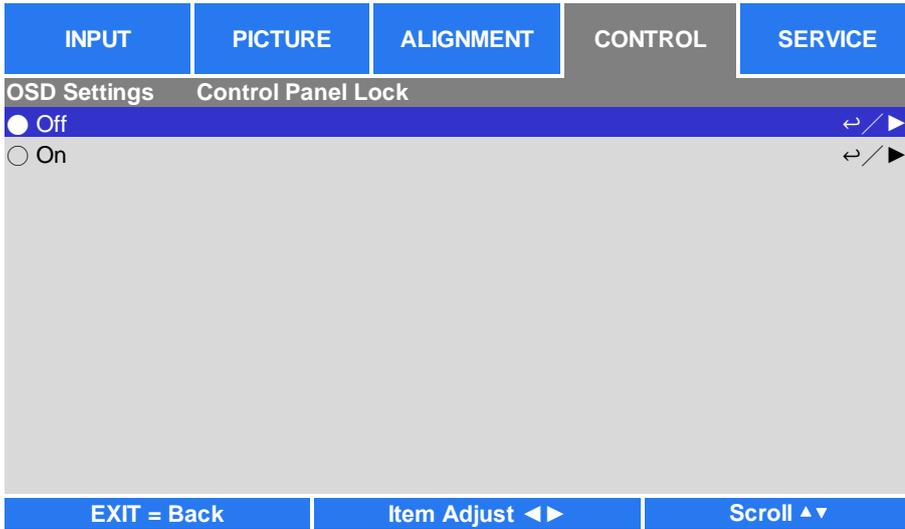

Using Security Lock

This function allows you to lock the projector for preventing the unauthorized turning on the projector; the setting is valid when you turn on the projector next time.

Enable the Security Lock

Select CONTROL>OSDSetsings>Security Lock then select On to enable the function as below illustration.

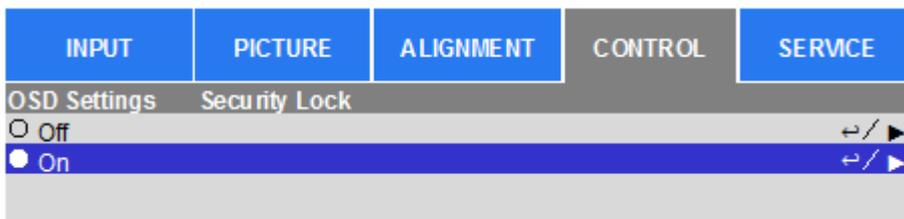
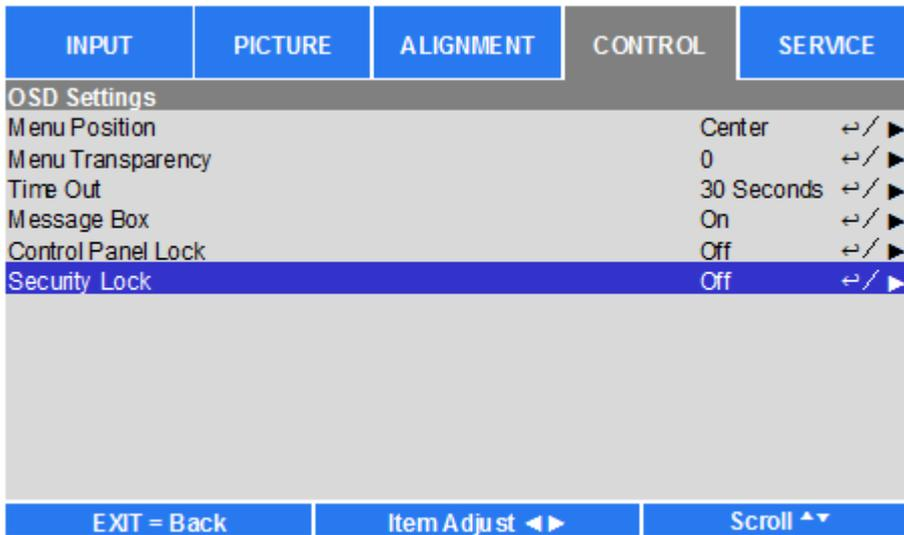

Once Security Lock is turned on, the pop-up message for setting up the password Lock as is shown as below. Press arrow buttons to set up your password, the password can be the combination of four arrow keys.

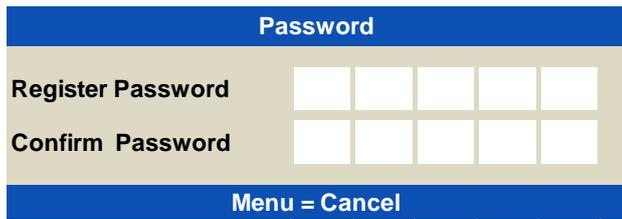

Control Panel Lock is turned on, the pop-up message will be shown Lock as below, select OK to confirm or Cancel to ignore the setting.



When you turn on the projector next time, the pop-up window will remind you to input the password to start the projection.

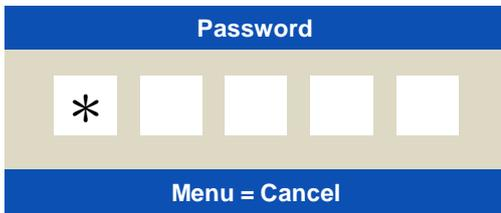

Unlocking the projector

The projector can be unlocked from OSD menu, enter CONTROL>OSDSettings>Security Lock and select Off to disable Security Lock as below illustration.

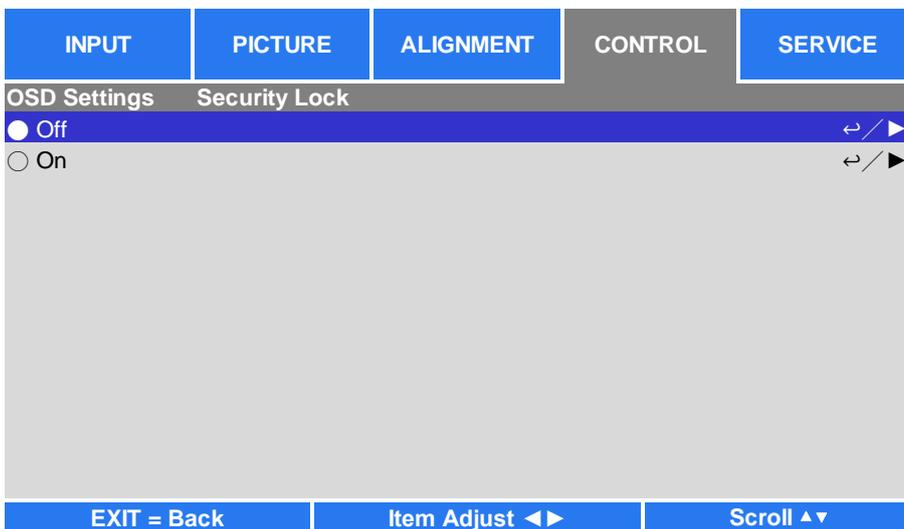

Once Off option is selected, the pop-up window will be displayed to confirm the setting. Select OK to disable the function, otherwise select Cancel to ignore the setting.



Using Control ID for Multi-projector Application

When installing more than one projector in the room, the projectors may receive the control signal at the same time. In this case, you can use control ID function to specify the identification of the projector and remote control to operate the specified projector. Follow below steps to set up the identification number for the projector and remote control.

Set the Projector identification number

1. Enable Projector ID Control function from CONTROL->Infrared Remote->ID Control Enable as below figure.

INPUT	PICTURE	ALIGNMENT	CONTROL	SERVICE
Language			English	↔/▶
Projection Mode			Auto	↔/▶
Cooling Condition			Front	↔/▶
High Altitude			Auto	↔/▶
Auto Power Off		<	Off	>
Auto Power On		<	Off	>
Network				↔/▶
Light Power			Normal	↔/▶
Custom Power Level			92%	
Background			Logo	↔/▶
Startup Logo		<	On	>
Infrared Remote				↔/▶
Trigger		<	Off	>
OSD Settings				↔/▶
EXIT = Back		Item Adjust ◀▶		Scroll ▲▼

INPUT	PICTURE	ALIGNMENT	CONTROL	SERVICE
Infrared Remote				
Remote Sensor			On	↔/▶
ID Control Enable			On	↔/▶
Control ID Number			2	↔/▶

The message box is displayed to confirm enabling ID control after selecting ON option, please OK button to confirm or Cancel button to skip it.

2. Set Control ID Number

Select Control ID Number option then press Enter buttons, use ▶ button to increase the number or ◀ button to decrease the number. This option is available when Projector ID Control is turned on.

Set the identification number of remote control

Press and hold ID SET button on the remote control around 5 seconds, Power led indicator is flashing red periodically. Press two digits to set desired ID number, each pressing shall be leisurely. Power LED will flash on time when the remote control is confirmed the setting.

Press and Hold ID SET button around 5 seconds



Power LED is flashing

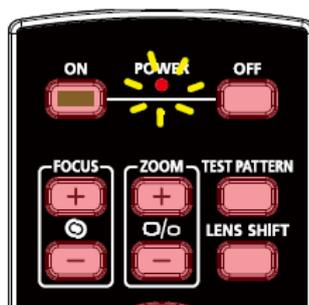

Press two digits for ID number



Note:

- Set the identification number will overwrite the ID number you set, you can set the ID number directly if you would like to give new ID number for the remote control.

Erase the identification number of the remote control

The set ID number is overwritten if new ID number is set, you can press ID SET and CLEAR button to erase ID number of the remote control

Press ID SET and CLEAR buttons simultaneously



The backlight of the buttons is flashing one time



Checking the identification number of the projector and remote control

The identification number of the projector and remote control can be checked by SERVICE menu as below figure, "X" represents that the function is not enabled; the number 26 is the current identification number of the remote control

INPUT	PICTURE	ALIGNMENT	CONTROL	SERVICE
Model	DU8190Z			
Serial Number	WDU81907010008			
Software Version 1	MD01-SD01-FD01			
Software Version 2	LE07-18-RE02-3120			
Control / Remote ID	X / 26			
Active Source	HDMI 1			
Signal Format	1280x800@60Hz			
H/V Refresh Rate	49.702 KHz / 59.81 Hz			
Pixel Clock	83.500 MHz			
Light Time	00001 HRS			
Thermal Status				← / ▶
Factory Reset				← / ▶
EXIT = Back		Item Adjust ◀ ▶		Scroll ▲ ▼

Note:

- Project ID Control function is available when the option is turned on and remote control wire is not plugged into the wire remote jack.
- If ID Control Enable is set to Off, projector can receive any control signal from the remote control even ID number is set into the remote control.

Making Connections

Follow the instructions below to connect DU8190Z projector to the video source, external control equipment (if any). When connecting to the equipment, use the correct signal cable to connect to the signal source and ensure that the cable is securely connected. Fasten the nut on the joint and connect the signal source equipment to the projector according to the figure below.

Connecting to Personal Computer

You can connect the PC signal to be projected to the projector through the DVI-D, HDMI, VGA or RGBHV (BNC) cable. If the signal to be input is VGA signal, connect the VGA cable to the external display to simultaneously monitor the projected content.

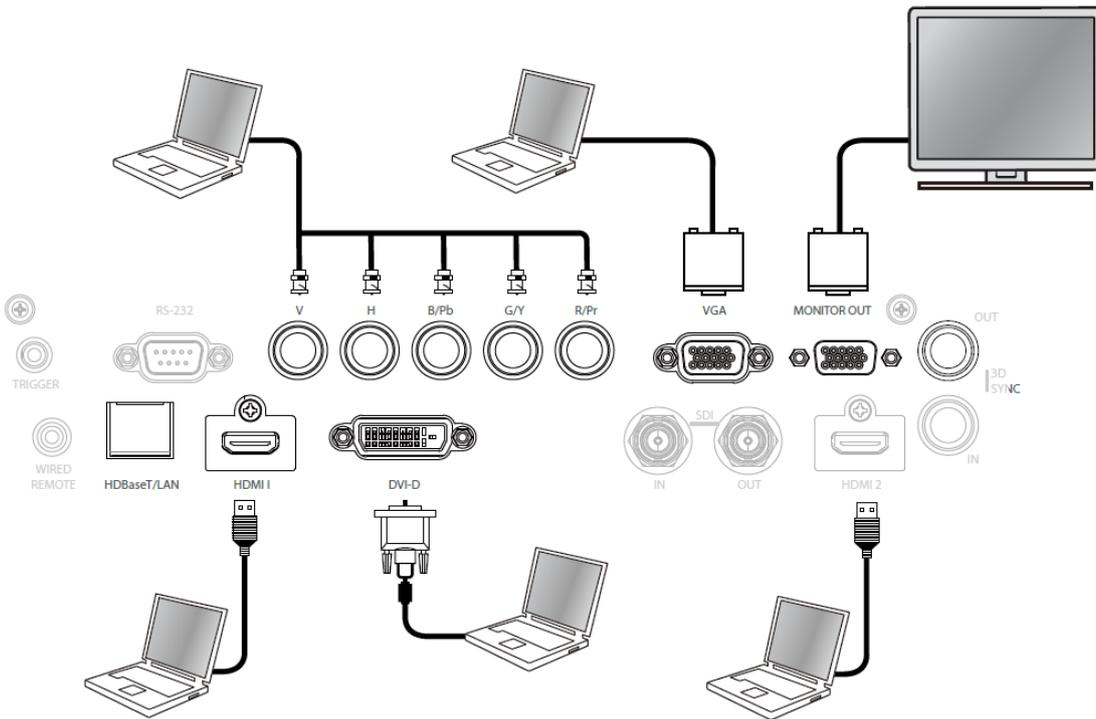

Connecting to the Video Device

Connect the video equipment to the input port of the projector via the DVI-D, HDMI and Component Video Connector.

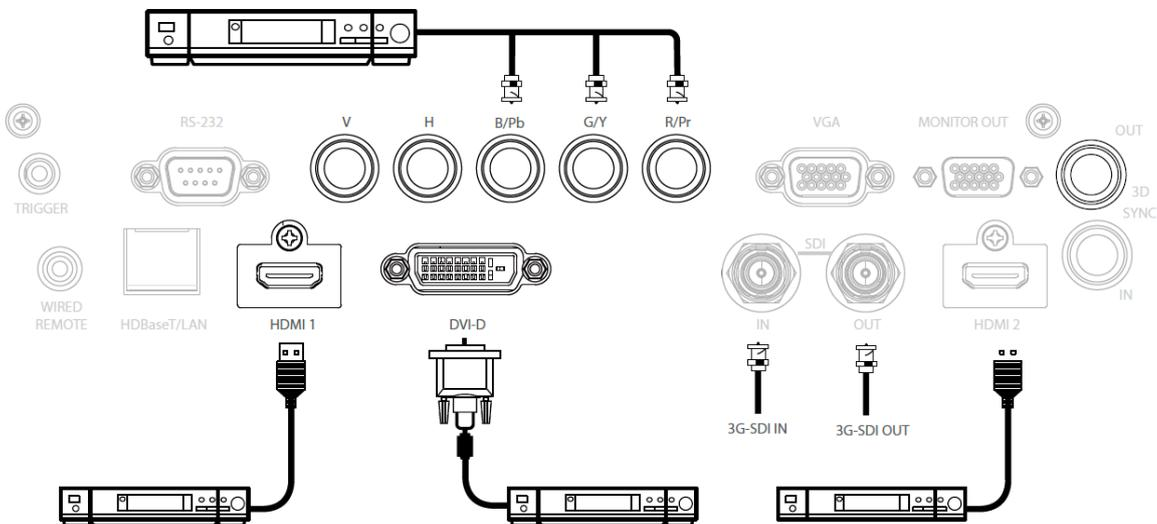

Connecting to the Control Equipment

The projector has the following control port for connecting to the control equipment:

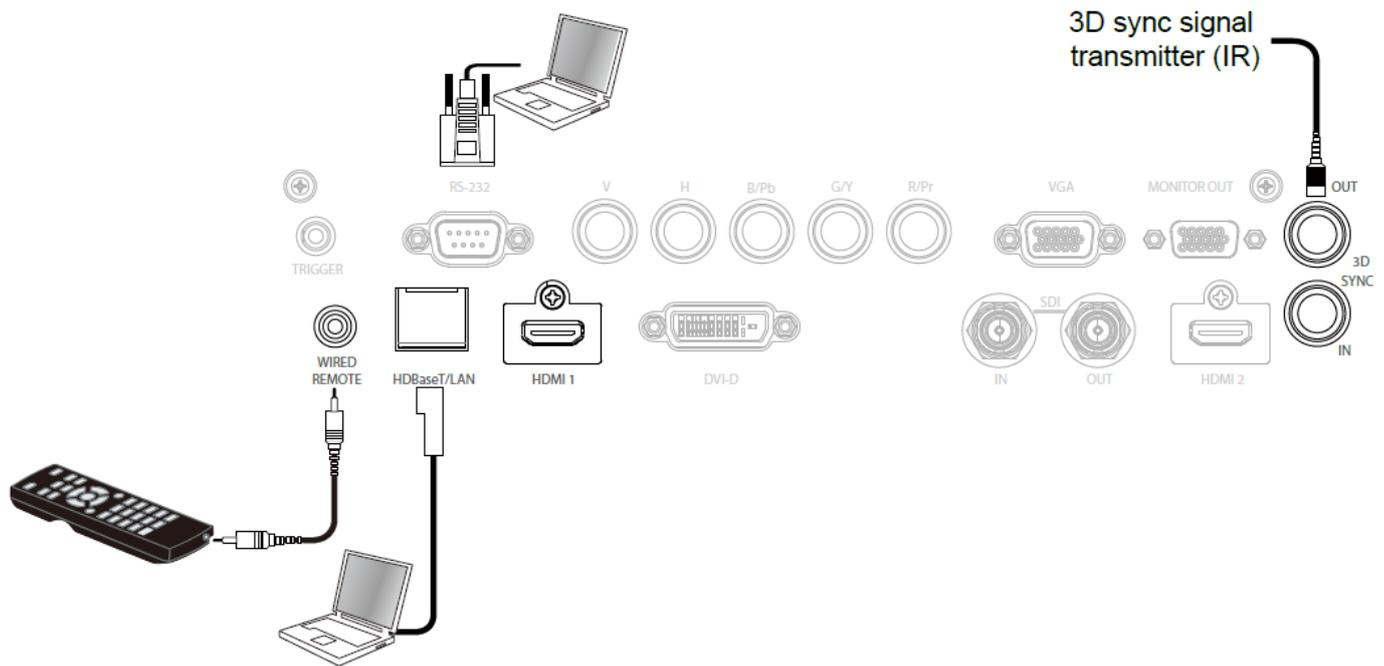

HDBaseT/LAN (Network control): The projector supports network control. LAN and HDBaseT share the one port. If only network control is used, you can connect the LAN on the projector to PC or through the local network. Refer to the Remote Communication Manual for detailed information.

RS-232 (RS-232 control): The projector can be remote-controlled by connecting the projector to PC or control system through the standard 9-pin serial cable (Straight Through Serial Cable). Refer to the Remote Communication Manual for detailed information.

Wired remote control: If the projector cannot receive the IR signal from the remote control due to the overly long distance or obstacles, you can connect the cable to the IR remote control or the external IR transmitter (optional) via the WIRE input port to expand the working range of the remote control.

3D Sync Out/In: Connect to 3D IR sync signal transmitter or device.

Caution:

- When the terminal of the remote control cable is inserted to the wired control terminal of the projector, the projector will automatically switch to the wired control mode and cannot be controlled through the IR signal of the remote control. Disconnect the wired control terminal on the projector if you want to control through the IR signal of the remote control.
- If the wired remote control cable or the external IR transmitter is inserted to the incorrect port, such as Trigger, the remote control or the IR transmitter may be damaged. Make sure whether the port is correct

Connecting to the Screen Trigger

If your projection system includes the electric projection screen and other 12V trigger device, you can connect these devices to the 12V trigger to output and configure the output 12V signal settings. The projector will output 12V signals when it's turned on. You can use the signal to control the screen or device.

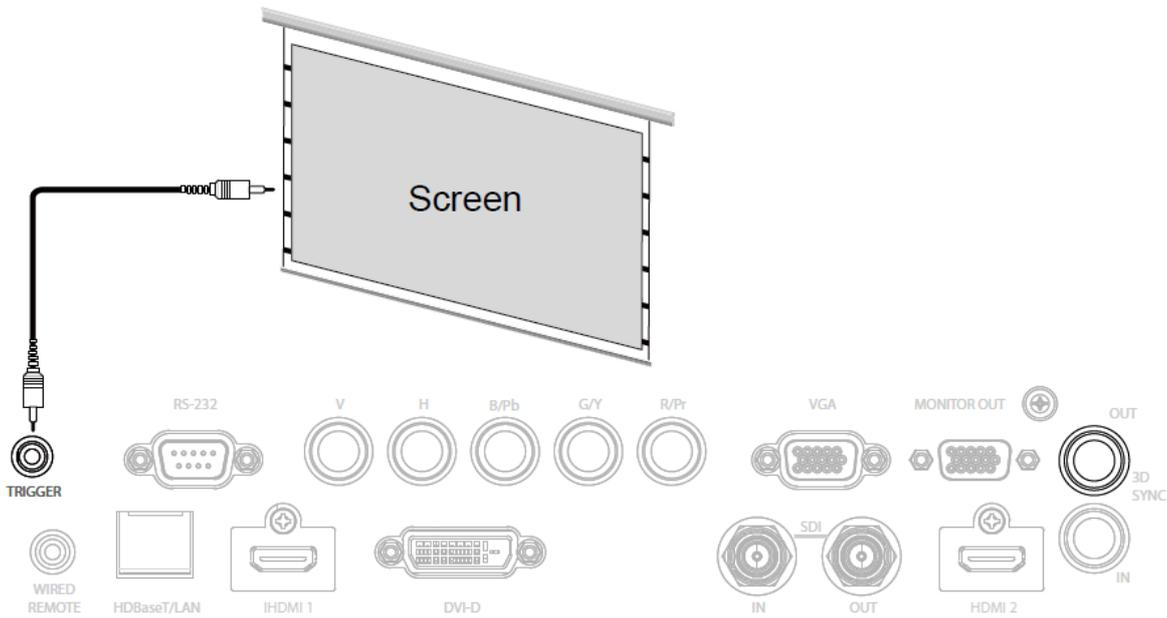

Connecting to external HDBaseT Transmitter

The projector has a built-in HDBaseT receiver. With HDBaseT Transmitter (optional), the video, RS-232 and LAN signals can be sent to the projector via a single RJ-45 cable. If the HDBaseT Transmitter you purchased supports the input and output of the IR remote control, the control signals from the IR remote control can be sent to the DU8190Z projector via the RJ-45 cable.

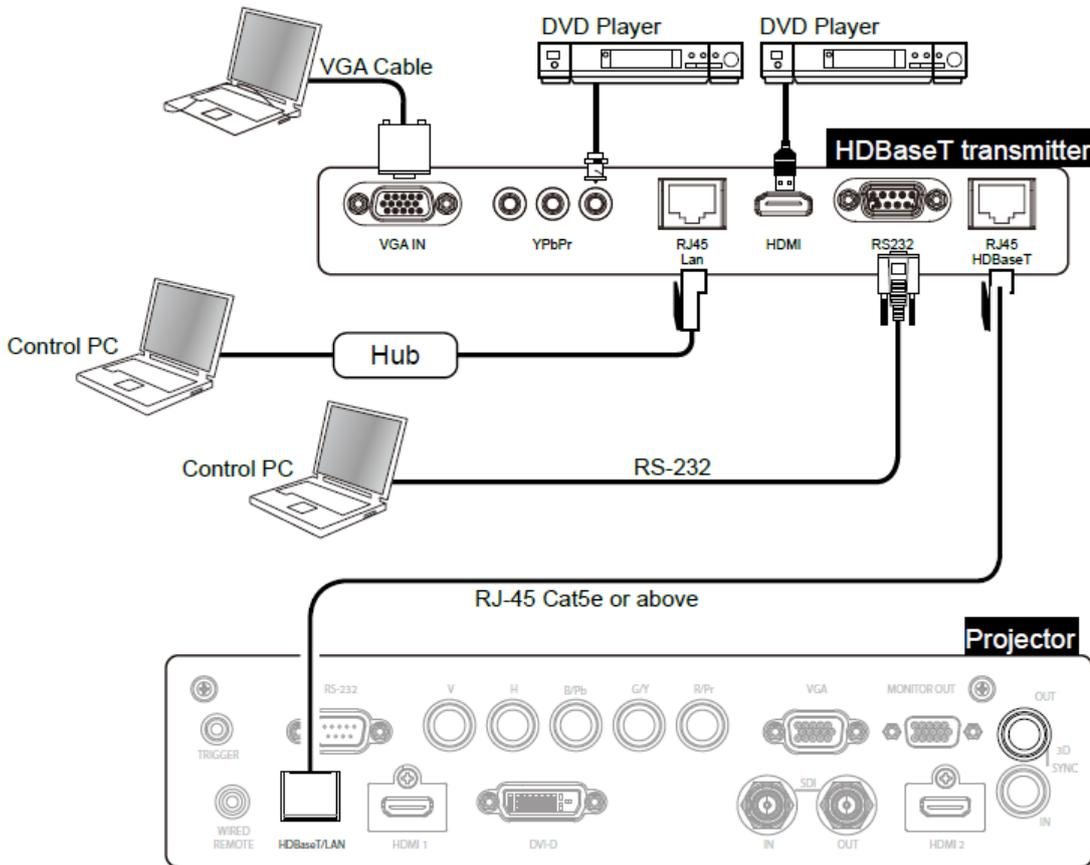

Note:

- The projector supports the video signal, R-232, IR remote control and the reception of the network control signals but do not support Power over Ethernet (PoE).
- The baud rate will be switched to 9600 automatically. If RS232 command is sent via external HDBaseT transmitter.
- If the command is sent via the HDBaseT transmitter, the longest transmission distance is 100 meters. The projection may be interrupted or interfered, or the control signal cannot be sent if the transmission distance is exceeded.
- Use the RJ-45 Cat5e or above cable and avoid entwining. Entwining may cause damage or interfering signal transmission, reduce the transmission distance and degrade the image quality.

Using the projector

Using On-Screen Display

Using the OSD Menu

The projector has an On-Screen Display (OSD) that lets you make image adjustments, change various settings and check current projector status.

INPUT	PICTURE	ALIGNMENT	CONTROL	SERVICE
Input Selection				HDMI 1 ↵/▶
PIP			Off	HDMI 2 ↵/▶
Auto Source		<	Off	>
Color Space		<	Auto	>
Aspect Ratio		<	Source	>
Overscan		<	Off	>
VGA Setup				↵/▶
Test Pattern				↵/▶
3D				↵/▶
Auto Sync				↵/▶

EXIT = Back Item Adjust ◀▶ Scroll ▲▼

Navigating the OSD

You can use the remote control or the control buttons on the projector to navigate and make changes to the OSD. The following illustration shows the corresponding buttons on the remote control and on the projector

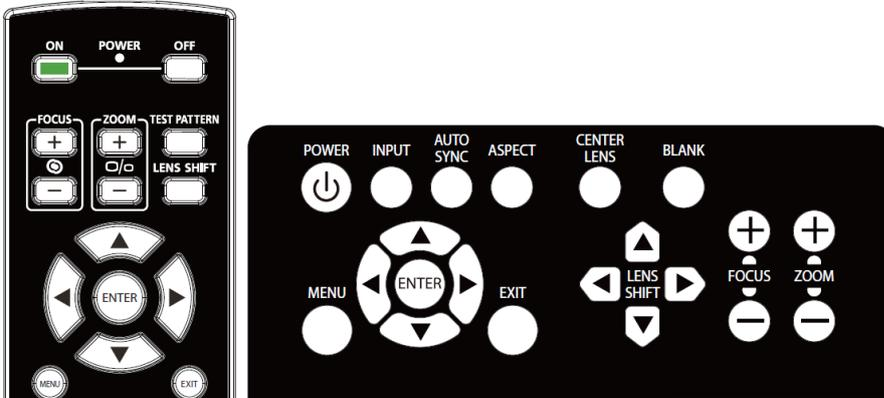

1. To open the OSD, press the **Menu** button on the OSD control panel or remote control. There are five folders on the menu. Press the cursor ◀ or ▶ buttons to move through secondary menus.

INPUT	PICTURE	ALIGNMENT	CONTROL	SERVICE
Input Selection				HDMI 1 ↵/▶
PIP			Off	HDMI 2 ↵/▶
Auto Source		<	Off	>
Color Space		<	Auto	>
Aspect Ratio		<	Source	>
Overscan		<	Off	>
VGA Setup				↵/▶
Test Pattern				↵/▶
3D				↵/▶
Auto Sync				↵/▶

EXIT = Back Item Adjust ◀▶ Scroll ▲▼

2. Press ▲ or ▼ to select menu items and ◀ or ▶ to change values for settings. Press ◀ to confirm the new setting.
3. Press **RETURN** to leave a submenu or MENU to close menu

Menu Tree

Use the following table to quickly find a setting or determine the range for a setting.

Main Menu		Submenu	
INPUT	Input Selection	HDMI1	
		HDMI2	
		VGA	
		Component	
		BNC	
		DVI	
		3G-SDI	
		HDBaseT	
		PIP	PIP Option
			PIP Input Position
	Auto Source		
	Color Space	Off	
		On	
		Auto	
		YPbPr	
	Aspect Ratio	YCbCr	
		RGB-PC	
		RGB-Video	
		5:4	
		4:3	
		16:10	
		16:9	
		1.88	
2.35			
Letterbox			
Overscan	Source		
	Native		
	Off		
VGA Setup	Crop		
	Zoom		
	H Total		
	H Start		
Test Pattern	V Phase		
	V Start		
	White		
	Black		
	Red		
	Green		
	Blue		
	Checker Board		
	Crosshatch		
	H Burst		
V Burst			
3D	Color Bar		
	3D Format		
	Eye Swap		
	DLP Link		
	Dark Time		
Auto Sync	Sync Delay		
	Sync Reference		
	Execute		
PICTURE	Picture Mode	High Bright	
		Presentation	
	Brightness	Video	
		Contrast	
		Saturation	
		Hue	
		Sharpness	
Color Temperature	5400K		

		6500K
		7500K
		9300K
		Native
	Gamma	1.0 / 1.8 / 2.0 / 2.2 / 2.35 / 2.5 / S-Curve
	Input Balance	Red Offset Green Offset Blue Offset Red Gain Green Gain Blue Gain
	HSG	Red Green Blue Cyan Magenta Yellow White Reset
	Noise Reduction	
	Dynamic Black	Off On
ALIGNMENT	Lens Lock	Off On
	Lens Control	Zoom Focus Lens Shift
	Lens Type	Non-UST Lens UST Lens
	Lens Memory	Load Memory Save Memory Clear Memory
	Center Lens	Execute
	Digital Zoom	Digital Zoom Digital Pan Digital Scan
	Warp	Keystone Rotation Pincushion/Barrel Top Left Corner Top Right Corner Bottom Left Corner Bottom Right
	Blanking	Top Bottom Left Right Reset
	Edge Blend	Edge Blend Align Pattern White Level Black Level Reset
	Screen Format	16:10 16:9 4:3
CONTROL	Language	
	Projection Mode	Front Desktop / Front Ceiling / Rear Desktop / Rear Ceiling
	Cooling Condition	Desktop / Ceiling / Freetilt / Portrait / Auto
	High Altitude	Off Auto
	Auto Power Off	Off On

Auto Power On	Off On
Network	Standby Power DHCP IP Address Subnet Mask Gateway DNS Mac Address
Light Power	Eco Normal Custom
Custom Power Level Background	Logo Black Blue
Startup Logo	Off On
Infrared Remote	Remote Sensor ID Control Enable Control ID Number
Trigger	Off Screen 5:4 4:3 16:10 16:9 1.88 2.35 Letterbox Source Native
OSD Setting	Menu Position Menu Transparency Time Out

SERVICE	Model Serial Number Software Version 1 Software Version 2 Control / Remote ID Active Source Signal Format H/V Refresh Rate Pixel Clock Light Time Thermal Status Factory Reset
---------	---

OSD Menu – INPUT

INPUT	PICTURE	ALIGNMENT	CONTROL	SERVICE
Input Selection				HDMI 1 ↵/▶
PIP			Off	HDMI 2 ↵/▶
Auto Source		<	Off	>
Color Space		<	Auto	>
Aspect Ratio		<	Source	>
Overscan		<	Off	>
VGA Setup				↵/▶
Test Pattern				↵/▶
3D				↵/▶
Auto Sync				↵/▶
EXIT = Back		Item Adjust ◀▶		Scroll ▲▼

Input Selection

Use the shortcut key on the remote control or this function to select the input source; the Input options are as below. The available input source of the product is HDMI 1, HDMI 2, VGA, Component (BNC), HDBaseT, DVI and 3G-SDI.

PIP

This function allows you to split the screen for displaying the images from two input sources

PIP Option

Enable PIP by choosing “ON”, and two windows will be shown on the projected picture. The larger one is the primary picture, the smaller one is the sub picture. By choosing “Off”, PIP function will be disabled, and only one picture window projected.

PIP Input

Press ENTER to display available sources for the sub picture, and then select a source.

Note: The unavailable input sources of sub-menu will be gray out and cannot be selected. The available input source of sub picture is as below combination list.

		Main Picture						
		VGA	Component	HDMI 1	HDMI 2	HDBaseT	3G-SDI	DVI
Sub Picture	VGA		○	○		○		○
	Component			○		○		○
	HDMI 1	○	○		○		○	
	HDMI 2			○		○		○
	HDBaseT	○	○		○		○	
	3G-SDI			○		○		○
	DVI	○	○		○		○	

Position

Find preferred location of PIP window.

Top Left: Display sub picture at top left of the screen.

Bottom Left: Display sub picture at bottom left of the screen.

Top Right: Display sub picture at top right of the screen.

Bottom Right: Display sub picture at bottom right of the screen.

PBP: Display sub picture next to main picture, the main screen is shrined to the same size as sub picture.

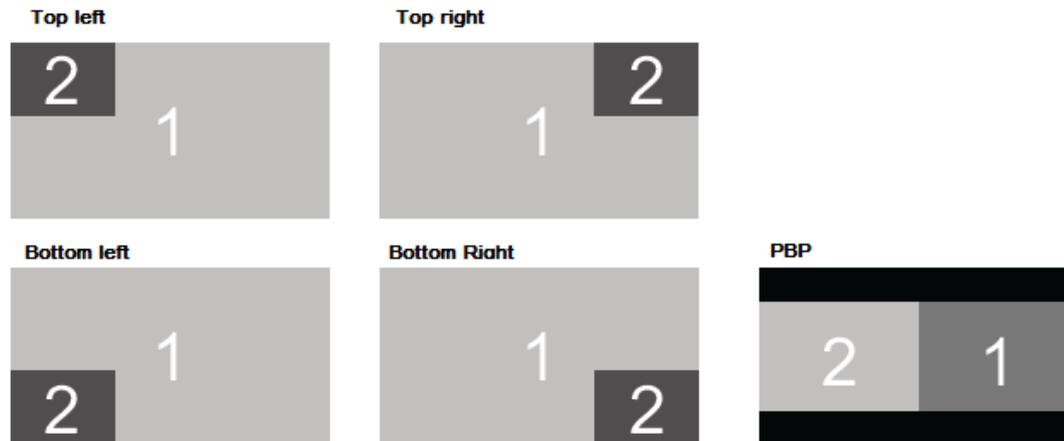

Auto Source

The Auto Source functions "ON" lets projector automatically search for the input signal.

Color Space

This function allows you to change the corresponding color space for the input signal in most cases, the default is Auto.

Auto: The projector detects the input signal and switches to the corresponding color space automatically.

YPbPr: Set the color space to ITU-R BT 601.

YCbCr: Set the color space to ITU-R BT 709.

RGB-PC: Use the RGB color space and set the black to 0, 0, 0 RGB, while set the white to 255, 255, 255 RGB (if an 8-bit image is used).

RGB-Video: Use the RGB color space and set the black to 16, 16, 16 RGB while set the white to 235, 235, 235 (if an 8-bit image is used) to correspond to the luminance value defined in the digital component standard.

Aspect Ratio

This function allows the user to adjust the aspect ratio of the projection image by ◀ ▶ keys.

Overscan

Noise may appear on the edge of the projected image or image may be small than projected image, select below option to hide the noise or extend the image.

Off: Display the original image.

Crop: Hide the edge of the image

Zoom: Extend the image to fit the projected area as possible.

VGA Setup

Set the H Total, H Start, H Phase and V Start for the VGA signal by ENTER key.

Test Pattern

The built-in images are provided for installation and adjustment. You can select Test Pattern on OSD or the TEST PATTERN button on the remote control to show the test pattern. Press the ◀ or ▶ to select pattern or press EXIT key again to exit the test pattern. The available test pattern options are White, Green, Crosshatch, Color Bar, Black, Blue, H-Burst, Red, Chess Board and V Burst.

3D

This function is to set the 3D format and sync method. The projector detects the type of input signals and provides relevant options for setting. Before performing 3D setting, make sure that the input signal is connected.

3D Format

Off: Turn off the 3D Display Mode. When Auto, Side by Side, Top and Bottom, or Frame Sequential is selected, the 3D Mode will be turned on. To turn off the 3D Mode, select “Off” and press “ENTER”.

Auto: Allow the 3D format to automatically detect the formats of Frame Packing, Top and Bottom, and Side by Side. The input signal is HDMI 1.4a 3D.

Side by Side (Half): This option is only applicable to input signal HDMI 1.4a 3D or HDMI signal sent by HDBaseT Transmitter.

Top and Bottom: This option is only applicable to input signal HDMI 1.4a 3D or HDMI signal sent by HDBaseT Transmitter.

Frame Sequential: Set input format under Frame Sequential.

Eye Swap: If the 3D image transmitted to the 3D glasses is reverse, you can set the Eye Swap to “Reverse” to normalize the image. Otherwise, keeping mode of “Normal” would be suggested.

DLP Link: This function is to activate or deactivate the DLP Link sync.

Dark Time: Manually switch the Dark time for glasses tolerance, the available options are 0.65ms, 1.3ms and 1.95ms.

Sync Reference: The projector provides DLP Link and 3D IR sync for 3D display, you can specify the built-in DLP Link or external 3D IR transmitter to synchronize the signal of the 3D glasses, or select Auto to set the sync signal depended on the 3D format and if external 3D sync device is connected. This function is only applied to the condition that 3D Format is Frame Sequential or external 3D sync device is connected to the projector.

External: Signal is sent from external 3D sync signal receiver.

Internal: Signal is sent by the projector, 3D sync signal is DLP Link.

Auto: Projector select 3D sync signal depended on the 3D format and if the extend 3D sync device is connected.

Auto Sync

You can use this function to execute signal source auto synchronization.

Important reminders:

- People with the following conditions should view 3D image with great care:
- Children under six years in age
- People who are allergic to light, unhealthy and have the history of cardiovascular diseases
- People who are tired or lack of sleep
- People who are under the impact of drug or alcohol
- Normally, it is safe to watch 3D images. However, some people might feel uncomfortable.
- Refer to the guidelines revised and released by the 3D League on December 10, 2008 who watch 3D images need to take a break for at least 5 to 15 minutes every thirty minutes or one hour.

OSD Menu – PICTURE

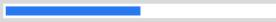
INPUT	PICTURE	ALIGNMENT	CONTROL	SERVICE
Picture Mode		<	High Bright	>
Brightness				100
Contrast				100
Saturation				100
Hue				100
Sharpness				0
Color Temperature		<	Native	>
Gamma		<	2.2	>
Input Balance				↔/▶
HSG				↔/▶
Noise Reduction				0
Dynamic Black			Off	↔/▶
EXIT = Back		Item Adjust ◀▶		Scroll ▲▼

Picture Mode

Use ◀ or ▶ to select desired picture mode

High Bright: The highest brightness output mode is suitable for the application where the highest brightness output is needed.

Presentation: The best projection effect is suitable for the presentation or picture.

Video: The mode is suitable for playing video content.

Brightness

Press ENTER, and use ◀ or ▶ to increase or decrease the level of brightness.

Contrast

Press ENTER, and use ◀ or ▶ to adjust the contrast of the projected image.

Saturation

Press ENTER, and use ◀ or ▶ to adjust the level of saturation.

Hue

Press ENTER, and use ◀ or ▶ to adjust the level of hue.

Sharpness

Press ENTER, and use ◀ or ▶ to adjust the sharpness, which changes the high-frequency details.

Color Temperature

The default of color temperature is Native, and it is suitable for most situations. As color temperature rises, the picture will appear bluer, while as the color temperature decreases, the picture will appear redder. The available options are Native, 5400K, 6500K, 7500K and 9300K

Gamma

When the ambient light is so bright that may affect the projection of the details in the dim area of the image, you can change the gamma to adjust the chrominance. The available options are 1.0, 1.8, 2.0, 2.2, 2.35, 2.5 and S-Curve.

Input Balance

When ambient light is too bright or changes, the projected image details may be affected, you can adjust the option to make the projected colors of image closer to desired colors. There are two options for fine tuning Red, Green and Blue.

Offset: These three options will shift the color spectrum for the whole image and change its brightness, if minimal amount of red, green or blue appears in the gray areas, you can adjust the offset of the corresponding color accordingly. By increasing the offset, the image brightness will become lower.

Gain: These three options are used to increase or decrease the range of color input for the entire image. If minimal amount of red, green or blue appears in the gray areas, lower the gain of the corresponding color accordingly. As gain increases, the contrast of the image will become lower.

HSG

HSG is a function to adjust Hue, Saturation and Gain independently, it allows for specified color adjustments that are more intuitive. You can adjust Hue, Saturation and Gain for Red, Green, Blue, Cyan, Magenta, Yellow and white independently.

Noise Reduction

Use ◀▶ to adjust the noise of the projected image. This function is used to remove the noise of the image with interlaced scanning input. Generally, noise reduction can lower the high-frequency details and make the image softer.

Dynamic Black

This is function can be used to enhance the black level of the projected image.

OSG Menu – ALIGNMENT

INPUT	PICTURE	ALIGNMENT	CONTROL	SERVICE
Lens Lock			Off	↵/▶
Lens Control				↵/▶
Lens Type			non-UST Lens	↵/▶
Lens Memory				↵/▶
Center Lens				↵/▶
Digital Zoom				↵/▶
Warp				↵/▶
Blanking				↵/▶
Edge Blend				↵/▶
Screen Format			16:10	

EXIT = Back
Item Adjust ◀▶
Scroll ▲▼

Lens Lock

This function can be used to disable lens control for preventing unauthorized operation or disoperation in lens control related functions including Lens Shift, Zoom/Focus adjustment and Center Lens. Recommend to turn on Lens Lock function to disable the Lens control after lens adjustment is done.

Note:

- Turning on Lens Lock will disable lens control function including Lens Shift, Center Lens and Zoom/Focus adjustment, please make sure Lens Lock is disable before you perform the lens control function.

Lens Control

Select this function to open Lens Control menu for adjustment of Zoom, Focus, or Shift. You can use the ENTER button to switch the Zoom / Focus or Shift menu. Use ▲or▼ to adjust zoom and vertical shift of the lens, or use ◀▶ to adjust focus and horizontal shift of the lens.

Lens Type

There are eight projections lens can be used in DU8190Z; the initial projection position of Ultra Short Throw (UST) Lens is different to other seven projection lenses. The projector preset two initial projection positions for these two types accordingly, Center Lens function can moves the lens to the initial position (center) automatically per the setting. Please set this option to UST Lens if Ultra Short Throw Lens is installed in the projector, otherwise please set it to

Note:

- There are two default positions, one is for regular zoom or fixed focus lens (Non-UST), the reference position is 0% of image width in horizontal shift and 0% of the image height in vertical shift; another one is for Ultra Short Throw Lens (UST), the default position is around 0% of image width in horizontal shift and 56% of image height in vertical shift. When performing Center Lens functions, projector will move the lens to the default position according to Lens type setting.
- If Ultra Short Throw Lens is installed and UST Lens is selected, you can perform Center Lens to move Lens to initial projection position automatically.
- If using Ultra Short Throw Lens and setting to Non-UST Lens, the lens will be moved to the position which is lower than the default position of Ultra Short Throw Lens after performing Center Lens function, it causes the projected image is blocked by the top cover of the projector. In this case, please perform the Lens shift function to move up the Lens till the image can be projected normally.
- please make sure Lens Type setting is set to Non-UST Lens then perform Center Lens function if other zoom lens or fixed focus lens is used, or lens shift range is limited, center position of the lens is not correct.

Lens Memory

This projector supports Lens Memory function, Lens shift, Zoom and Focus memory can be stored in the projector up to 10 sets. You can load the stored memory setting to set up the lens automatically.

Load Memory: Use ▲▼ to select the desired memory setting then press ENTER button to execute the lens setting, the projector will adjust the Lens position, Zoom and Focus automatically.

Save Memory: Use ▲▼ to select the memory set for storing the setting then press ENTER button to confirm.

Clear Memory: Select the memory set to be cleared then press ENTER button to confirm clearing memory set.

Center Lens

This is the lens calibration function, the projector calibrates the lens shift, focus and zoom parameters for the precise lens memory function. After performing this function, the lens will be moved to the center position as factory default setting.

Note:

- There are two default center positions for UST (Ultra Short Throw) Lens and non-UST Lens, make sure Lens Type setting is correct before performing this function.
- If Ultra Short Throw Lens is installed, make sure the support kit is detached before performing Center Lens.

Digital Zoom

Press ENTER button to select the options to enlarge the image or shift the image.

Digital Zoom: Use ◀▶ to enlarge the projected image.

Digital Pan: Use ◀▶ to move the projected image horizontally. This function is only available when projected image is enlarged.

Digital Scan: Use ◀▶ to move the projected image vertically. This function is only available when projected image is enlarged.

Reset: The setting will be reset to default value.

Warp

This function is used to correct the distortion of image.

Keystone: Press ◀▶ to correct horizontal distortion or ▲▼ to correct vertical distortion.

Rotation: Press ◀▶ to correct incorrect angle of image.

Pincushion / Barrel: Press ◀▶ to correct pincushion/barrel distortion.

Top Left Corner: Press ◀▶ to correct the distortion at top-left of the picture.

Top Right Corner: Press ◀▶ to correct the distortion at top-right of the picture.

Bottom Left Corner: Press ◀▶ to correct the distortion at bottom-left of the picture.

Bottom Right Corner: Press ◀▶ to correct the distortion at bottom-right of the picture.

Blanking: This function can adjust the edges of the image and hide surplus sections of the projection.

Top: Press ▲▼ to adjust the top blanking area on the projected picture.

Bottom: Press ▲▼ to adjust the bottom blanking area on the projected picture.

Left: Press ◀▶ to adjust the left blanking area on the projected picture.

Right: Press ◀▶ to adjust the right blanking area on the projected picture.

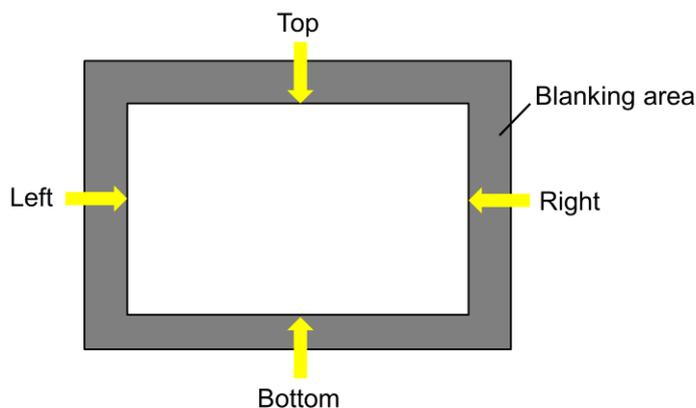

Reset

All the settings toward blanking will set to default.

Edge Blend

Edge Blend function requires multiple projectors to simultaneously project on the same screen. Use this function to adjust the uniformity of image. To use this function, Edge Blending must be enabled on both projectors. The functions as follows can be only adjusted when Edge Blend is turned on.

Edge Blend: If the user would like to function Edge Blend, turn this function to On.

Align Pattern: If user turns this function to On, the projector will show pattern for user to adjust the overlapping part of projection

White Level: White Level is used to set the overlapped area for blending in multi-projection application, the overlapping When projecting White, the area where the two images overlap is projected twice the projectors' white output levels. The solution is to adjust the White Level. First make sure that the units connected to the projectors are outputting black. Then increase the White Level (Top, Bottom, Left, and Right) until the non-overlap area's brightness matches the overlap area.

Black Level: The purpose of Black Level is to increase the black level of non-overlapping area. When projecting black, the area where the two images overlap projects twice the projectors' black output levels. The solution is to adjust the Black Level. First make sure that the units connected to the projectors are outputting black. Then increase the Black Level (Top, Bottom, Left, and Right) until the non-overlap area's brightness matches the overlap area.

Reset: All the settings toward edge blend will set to default.

Screen Format: Sleet the screen format to 16:10, 16:9 and 4:3.

OSD Menu – CONTROL

INPUT	PICTURE	ALIGNMENT	CONTROL	SERVICE
Language			English	↔/▶
Projection Mode			Auto	↔/▶
Cooling Condition			Front	↔/▶
High Altitude			Auto	↔/▶
Auto Power Off		<	Off	>
Auto Power On		<	Off	>
Network				↔/▶
Light Power			Normal	↔/▶
Custom Power Level			92%	
Background			Logo	↔/▶
Startup Logo		<	On	>
Infrard Remote				↔/▶
Trigger		<	Off	>
OSD Settings				↔/▶
EXIT = Back		Item Adjust ◀▶		Scroll ▲▼

Language

Select desired OSD language, the available languages options are English, Española, Deutsch, Portuguese, 简体中文, 繁體中文, 日本語, 한국어.

Projection Mode

The projection mode option can be used to change the orientation of the projected image or flip the projected image.

Front Desktop: Install the projector on the table and project the image on the screen forward.

Front Ceiling: Mount the projector on the ceiling and project the image on the screen forward, the image is overturned.

Rear Desktop: Install the projector on the table and project the image from the rear of the screen.

Rear Ceiling: Mount the projector on the ceiling and project the image from the rear of the screen, the image is overturned.

Cooling Condition

The projector is equipped with orientation sensor for switching cooling condition automatically; you can set it to Auto or adjust the cooling condition by manual.

Front: The projector is installed on the table.

Ceiling + Front: The Projector is mounted on the ceiling.

Freetilt: The projector is installed with tilt angle; the angle is over 30 degree.

Auto: Built-in sensor detects the installation orientation and switches to corresponding cooling condition.

Note:

- Incorrect Projection Mode setting may affect hot air exhausting from the projector, the heat and high temperature may cause the projector to enter system protection or damage component.

High Altitude

Use this function to adjust the cooling fan of the projector to get well cooling if the projector is installed in an area over 5000 feet. The projector is equipped with altitude sensor which is capable of detecting atmosphere pressure for estimating altitude; it can adjust automatically to corresponding setting based on estimated altitude if this option is set to Auto. If you prefer to set it by manual, you can select On or Off.

Off: Turn off High Altitude mode if the projector is installed in an area under 5000 feet.

On: Turn on High Altitude mode if the projector is installed in an area over 5000 feet.

Auto: Set up this mode automatically by estimated altitude.

Note:

- Estimate Altitude is calculated by atmosphere pressure, it may have the tolerance comparing to actual altitude.
- If any over temperature or system protection message, please adjust High Altitude by Manual.
- In some application, regular cooling fan setting may not supply enough cold air for system cooling even the projector is installed in an area under 5000 feet. In this case, please set High Altitude to On.

Auto Power Off

This function is set to OFF by default. When it is set to ON and no input signal is received within 20 minutes, the projector will turn off automatically.

Auto Power On

This function is set to OFF by default. When it is set to ON, the projector will turn on automatically when y AC power is turned on next time. You can use this function and the power switch (instead of the remote control) to turn on the projector. Set this function to OFF if it's unnecessary.

Network

Use this function to configurator the network settings so that you can control the projector via the network.

Press ▲ ▼ and Enter button to select Network and network settings. Please refer to Remote Communication Manual for further information.

Standby Power

This option allows you to set up power consumption at standby status,

On: Projector maintains in the standby at higher power consumption (< 6W) for projector control via LAN. In this mode, the projector can be turned on by RS-232 command or web control.

Off: Projector maintains in the standby at lowest power consumption (<0.5W), the projector can be turned on by the power button on the remote control or control panel only.

DHCP: Set DHCP to ON/OFF. When DHCP is set to ON, the DHCP server of the domain will assign an IP address to the projector. The IP address will appear on the IP address window without need to make any input. If the domain cannot assign any IP address, 0.0.0.0 will be shown on the IP address window.

IP Address: To specify an IP address, press the Enter button to show the IP address input window. Use the ◀▶ button to select the number in the address to change. Use the ▲ ▼ button to increase or decrease the number in the IP address. Network IP Address 172. xxx. xxx. xxx.

Subnet Mask: Set the subnet mask. The input method is the same as the setting for IP address.

Gateway: Set the gateway. The input method is the same as the setting for IP address.

DNS: Set the DNS. The input method is the same as the setting for IP address.

MAC Address: Show projector's MAC Address.

Light Power

Use the ◀▶ function to select the Eco, Normal or Custom Power Level mode.

Eco: Projection operates in the energy-saving mode, which is equivalent to 80 % power of light source.

Normal: Projection operating with normal light power can obtain the brightest projection display.

Custom Power Level: User can decide the power level depending on his or her preference.

Custom Power Level

Use the ◀▶ function to select the Custom Power Level. This function is available only when the Light Power is set to Custom Power Level, which range is allowed to adjust from 20% to 100% of normal mode, and it cannot be selected under the Normal or Eco mode.

Background

User can use this function to specify the image displayed on the blank screen when there is no input signal. The selectable items are Logo, Black and Blue, the default setting is Logo.

Startup Logo

Press ENTER button, and use the ◀▶ function to turn on / off the Startup Logo.

Infrared Remote

Remote Sensor: The default is On. However, there are three conditions that will be suggested to turn off "Remote Sensor"; the possible condition is that if the user uses wired control, he can set this function to Off, or that if the projector IR location is exposed to the bright sunlight or fluorescence, or that projector control is not controlled by remote. If the user would like to reset to On, user can only set by OSD panel or RS-232.

ID Control Enable: This option allows you to enable the projector ID control function. You can turn on this function and give an ID number for the projector, then set the same ID number for the remote control to match the projector ID. After ID code is set, you can control the specified projector by the remote control.

Control ID Number: Select the option then press ◀ or ▶ to set the ID number of the projector, this option is selectable when Projector ID Control is enabled.

Trigger

The projector is provided with a set of trigger output. User can connect the trigger to the screen with projector by the cable. If user does so, once the projector is powered, the screen would be automatically turned on as well. There is a 2-3 second delay to activate this function. The selectable aspect ratios are as follows:

Off: Turn off screen trigger.

5:4: Outputs 12V of power on Trigger when Aspect Ratio is set to 5:4.

4:3: Outputs 12V of power on Trigger when Aspect Ratio is set to 4:3.

16:10: Outputs 12V of power on Trigger when Aspect Ratio is set to 16:10.

16:9: Outputs 12V of power on Trigger when Aspect Ratio is set to 16:9.

1.88: Outputs 12V of power on Trigger when Aspect Ratio is set to 1.88.

2.35: Outputs 12V of power on Trigger when Aspect Ratio is set to 2.35.

Letterbox: Outputs 12V of power on Trigger when Aspect Ratio is set to Letterbox.

Native: Outputs 12V of power on Trigger when Aspect Ratio is set to Native.

Unscaled: Outputs 12V of power on Trigger when Aspect Ratio is set to Unscaled.

Auto: Outputs 12V of power on Trigger automatically.

OSD Settings

Menu Position: Adjust menu position through this function, the available position options are at Top-Left, Top-Right, Bottom-Left, Bottom-Right and center of the screen.

Menu Transparency: Change the transparency of OSD Menu, the background color of the OSD can be adjusted from darker to lighter if you want to display complete projected image.

Time Out: Set up the timer to exit OSD menu, the available options are Always On, 10 Seconds, 30 Seconds and 60 Seconds.

Message Box

This function allows you to disable the pop-up message at bottom-right of the screen.

OSD Menu – SERVICE

INPUT	PICTURE	ALIGNMENT	CONTROL	SERVICE
Model			DU8190Z	
Serial Number			WDU81907010008	
Software Version 1			MD01-SD01-FD01	
Software Version 2			LE07-18-RE02-3120	
Control / Remote ID			X / 26	
Active Source			HDMI 1	
Signal Format			1280x800@60Hz	
H/V Refresh Rate			49.702 KHz / 59.81 Hz	
Pixel Clock			83.500 MHz	
Light Time			00001 HRS	
Thermal Status				← / ▶
Factory Reset				← / ▶
EXIT = Back		Item Adjust ◀ ▶		Scroll ▲ ▼

Model

Display the project model name.

Serial Number

Display the serial number of the projector.

Software Version 1 / Software Version 2

Display the software version in the projector.

Control/Remote ID

Display current projector ID and remote control ID number.

Active Source

Display the current input source information.

Signal Format

Display current input source format

H/V Refresh Rate

Display horizontal and vertical refresh rate of the current picture.

Pixel Clock

Display pixel clock of the current input signal.

Light Time

Display accumulated usage of projection light source

Thermal Status

Display current of the thermal management components.

Factory Reset

The user can use this function to reset all the settings to factory default; light time.

Product Specification

Display Type	Single Chip 0.67" DLP Technology	
Brightness	10,000 ANSI Lumens	
Native Resolution	WUXGA (1920 x 1200)	
Maximum Resolution	WUXGA (1920 x 1200)@60Hz (Reduced Blanking)	
Contrast Ratio	100,000:1 (Full On/Full Off)	
Illumination Type	Laser Phosphor	
Throw Ratio*	1.73 - 2.27:1	
Image Size (Diagonal)*	40" - 500"	
Projection Distance*	1.45 - 24.85m (4.77ft to 81.52ft)	
Projection Lens*	F = 1.7 - 1.9, f = 26 - 34mm	
Zoom Ratio*	1.3x	
Aspect Ratio	16:10	
Offset	Motorized Lens Shift	
Keystone Correction	Horizontal $\pm 60^\circ$, Vertical $\pm 40^\circ$ (adjustable range of single direction)	
Horizontal Frequency	15, 30 – 90Hz	
Vertical Scan Rate	50 - 85Hz	
Edge Blending	Yes (Built-In)	
Warping	Yes (Built-In)	
3D Functionality	Yes (DLP® Link™, HDMI v1.4 (Blu-ray, side by side, frame packing, top and bottom))	
Adjustable Lens Shift Range	Vertical: -33% to +64%, Horizontal: -14% to 24%	
I/O Connection Ports	HDMI v1.4a (x2) DVI-D, Component (5 BNC), VGA-In, 3G-SDI-In/Out, RS-232, VGA-Out, 3D-Sync In/Out, 12v Trigger, Wired Remote, HDBaseT™/LAN (Shared)	
Projection Method	Table Top, Ceiling Mount (Front or Rear), Free-tilt , Portrait	
Security Solutions	Kensington® Security Slot, Security Bar, Anti-Theft Lens Screw	
Dimensions (WxDxH)	500 x 580 x 205mm (19.7" x 22.8" x 8.1")	
Weight	29kg (63.9lbs)	
Available Colours	White (DU8190Z-WH), Black (DU8190Z-BK)	
Noise Level	42dB (Normal Mode)	
Power Supply	AC 100-240V, 50/60Hz	
Power Consumption	Normal Mode	1320W @100Vac, 1245W @240Vac
	Standby Power On	Less than 6W
	Standby Power Off (Eco)	Less than 0.5W
Operation Condition	At temperature 0 to 40° C, relative humidity 10% to 85%,non-condensation	
Storage Condition	At temperature -10 to 60° C,relative humidity 5% to 95%,non-condensation	
Standard Accessories	AC Power Cord, Remote Control w/Batteries, Lens Cap, Anti-Theft Lens Screw, Documentation Kit	
Optional Accessories	Interchangeable Lens Options	

*Note: Standard Lens

**Note: Lens shift compatibility with all lenses except D88-WF18501 Wide Fixed Lens (3797745100-SVK) and D88-UST01 Ultra-Short Throw Lens (3797855700-SVK)

Supported Signal Input Timing

Signal Format	Resolution	H.Freq, (KHz)	Frame Rate (Hz)	Pixel Clock (MHz)	VGA	COMPONENT / BNC		HDMI / HD-BaseT			HD SDI
					RGBHV	RGBHV	Component	RGB	YUV (Bit)		
								8	10	12	
PC	640x480	31.47	59.94	25.18	O	O		O			
	640x480	37.50	75.00	31.50	O	O		O			
	640x480	43.27	85.00	36.00	O	O		O			
	800x600	37.88	60.32	40.00	O	O		O			
	800x600	46.88	75.00	49.50	O	O		O			
	800x600	53.67	85.06	56.25	O	O		O			
	848x480	23.67	47.95	25.00	O	O		O			
	848x480	31.02	60.00	33.75	O	O		O			
	1024*768	48.36	60.00	65.00	O	O		O			
	1024*768	56.48	70.07	75.00	O	O		O			
	1024*768	60.02	75.00	78.75	O	O		O			
	1024*768	68.68	85.00	94.50	O	O		O			
	1152x864	67.50	75.00	108.00	O	O		O			
	1280x720	35.53	47.95	57.99	O	O		O			
	1280 x 768	47.78	60.00	79.50	O	O		O			
	1280 x 768	60.29	74.89	102.25	O	O		O			
	1280 x 768	68.63	84.84	117.50	O	O		O			
	1280 x 800	49.70	60.00	83.50	O	O		O			
	1280 x 800	62.80	74.93	106.50	O	O		O			
	1280 x 960	60.00	60.00	108.00	O	O		O			
	1280 x 960	85.94	85.00	148.50	O	O		O			
	1280x1024	63.98	60.02	108.00	O	O		O			
	1280x1024	79.98	75.02	135.00	O	O		O			
	1280x1024	91.15	85.02	157.50	O	O		O			
	1366 x 768	47.71	60.00	85.50	O	O		O			
	1400X1050	65.32	60.00	121.75	O	O		O			
	1400X1050	82.28	74.87	156.00	O	O		O			
	1440 x 900	55.94	59.89	106.50	O	O		O			
	1440 x 900	70.64	74.98	136.75	O	O		O			
	1600x900	55.92	60.00	119.00	O	O		O			
	1600x1200	75.00	60.00	162.00	O	O		O			
	1680x1050	65.29	60.00	146.25	O	O		O			
	1920x1080	53.23	47.95	135.40	O	O		O			
1920x1200 RB	61.82	50.00	158.25	O	O		O				
1920x1200 RB	74.04	60.00	154.00	O	O		O				
800x600	76.30	119.97	73.25				O				
800x600	77.11	119.92	83.89				O				

Signal Format	Resolution	H.Frec, (KHz)	Frame Rate (Hz)	Pixel Clock (MHz)	VGA	COMPONENT / BNC		HDMI / HD-BaseT			HD SDI	
					RGBHV	RGBHV	Component	RGB	YUV (Bit)			
									8	10		12
	1024x768 RB	97.55	120.00	115.50				O				
	1024x768	98.62	119.83	138.86				O				
	1280x768 RB	97.40	119.80	140.25				O				
	1280x720	90.00	120.00	148.50				O				
	1280x800 RB	101.56	119.91	146.25				O				
Apple Mac	640x480	35.00	66.67	30.24	O	O		O				
	832x624	49.72	74.55	57.28	O	O		O				
	1024x768	60.24	74.93	80.00	O	O		O				
	1152x870	68.86	75.06	100.00	O	O		O				
SDTV	480i	15.73	59.94	13.50			O				O	
	1440x480i	31.47	60.00	27.00				O	O	O	O	
	1440x576i	31.25	50.00	27.00				O	O	O	O	
	576i	15.63	50.00	13.50			O				O	
EDTV	480p	31.47	59.94	27.00	O	O	O	O	O	O	O	
	576p	31.25	50.00	27.00	O	O	O	O	O	O	O	
HDTV	1035i	33.75	60.00	74.25	O	O	O	O	O	O	O	
	1080i	28.13	50.00	74.25	O	O	O	O	O	O	O	
	1080i	33.72	59.94	74.18	O	O	O	O	O	O	O	
	1080i	33.75	60.00	74.25	O	O	O	O	O	O	O	
	720p	37.50	50.00	74.25	O	O	O	O	O	O	O	
	720p	44.96	59.94	74.18	O	O	O	O	O	O	O	
	720p	45.00	60.00	74.25	O	O	O	O	O	O	O	
	1080p	26.97	23.98	74.18	O	O	O	O	O	O	O	
	1080p	27.00	24.00	74.25	O	O	O	O	O	O	O	
	1080p	28.13	25.00	74.25	O	O	O	O	O	O	O	
	1080p	33.72	29.97	74.18	O	O	O	O	O	O	O	
	1080p	33.75	30.00	74.25	O	O	O	O	O	O	O	
	1080p	56.25	50.00	148.50	O	O	O	O	O	O	O	
	1080p	67.43	59.94	148.35	O	O	O	O	O	O	O	
1080p	67.50	60.00	148.50	O	O	O	O	O	O	O		
PsF Format	1080sf	33.75	30.00	74.25							O	
	1080sf	27.00	24.00	74.25							O	
	1080sf	28.13	25.00	74.25							O	
HD-SDI	720p24	18.00	24.00	74.25							O	
	720p25	18.75	25.00	74.25							O	
	720p30	22.50	30.00	74.25							O	

Supported 3D Signal

Resolution	Frec, h (KHz)	Frame Rate (Hz)	Pixel Clock (MHz)	Input Source/ 3D Format					
				VGA-RGBHV	BNC-RGBHV	DVI-D / HDMI / HDBaseT			
				FS	FS	FS	SBS	TB	FP
640x480	31.47	59.94	25.18	O	O	O	O	O	
800x600	37.88	60.32	40.00	O	O	O	O	O	
848x480	31.02	60.00	33.75	O	O	O	O	O	
1024*768	48.36	60.00	65.00	O	O	O	O	O	
1280 x 768	47.78	60.00	79.50	O	O	O	O	O	
1280 x 800	49.70	60.00	83.50	O	O	O	O	O	
1280 x 960	60.00	60.00	108.00	O	O	O	O	O	
1280x1024	63.98	60.02	108.00	O	O	O	O	O	
1366 x 768	47.71	60.00	85.50	O	O	O	O	O	
1400X1050	65.32	60.00	121.75	O	O	O	O	O	
1440 x 900	55.94	59.89	106.50	O	O	O	O	O	
1600x900	55.92	60.00	119.00	O	O	O	O	O	
1600x1200	75.00	60.00	162.00	O	O	O	O	O	
1680x1050	65.29	60.00	146.25	O	O	O	O	O	
1920x1200 RB	61.82	50.00	158.25	O	O	O	O	O	
1920x1200 RB	74.04	60.00	154.00	O	O	O	O	O	
800x600	76.30	119.97	73.25	O	O	O			
800x600	77.11	119.92	83.89	O	O	O			
1024x768 RB	97.55	120.00	115.50	O	O	O			
1024x768	98.62	119.83	138.86	O	O	O			
1280x768 RB	97.40	119.80	140.25	O	O	O			
1280x720	90.00	120.00	148.50	O	O	O			
1280x800 RB	101.56	119.91	146.25	O	O	O			
1080i	28.13	50.00	74.25				O	O	
1080i	33.72	59.94	74.18				O	O	
1080i	33.75	60.00	74.25				O	O	
720p	37.50	50.00	74.25	O	O	O	O	O	O
720p	44.96	59.94	74.18	O	O	O	O	O	O
720p	45.00	60.00	74.25	O	O	O	O	O	O
1080p	26.97	23.98	74.18				O	O	O
1080p	27.00	24.00	74.25				O	O	O
1080p	28.13	25.00	74.25				O	O	O
1080p	33.72	29.97	74.18				O	O	O
1080p	33.75	30.00	74.25				O	O	O
1080p	56.25	50.00	148.50	O	O	O	O	O	O
1080p	67.43	59.94	148.35	O	O	O	O	O	O
1080p	67.50	60.00	148.50	O	O	O	O	O	O

FS: Frame Sequential

SBS: Side by Side

FB: Frame Packing

TB: Top and Bottom

*3D Glasses Refreshing Rate: 96/100/120Hz, . the output frame rate is up to 96Hz if input frame rate is 24Hz.

*3D Sync signal: DLP Link, IR

Configurations of Terminals

DVI-D Terminal

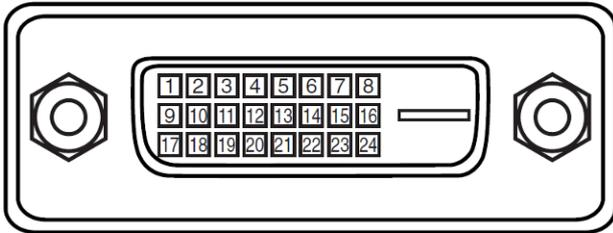

1	T.M.D.S. Data 2- Input	13	N.C
2	T.M.D.S. Data 2+ Input	14	P5V
3	Ground	15	Ground
4	N.C	16	HPD
5	N.C	17	T.M.D.S. Data 0- Input
6	SCL	18	T.M.D.S. Data 0+ Input
7	SDA	19	Ground
8	N.C	20	N.C
9	T.M.D.S. Data 1- Input	21	N.C
10	T.M.D.S. Data 1+ Input	22	Ground
11	Ground	23	T.M.D.S. Clock+ Input
12	N.C	24	T.M.D.S. Clock- Input

VGA Terminal (D-sub 15 pin)

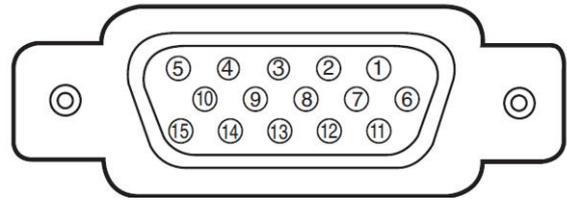

Input

1	Red Input	9	P5V
2	Green Input	10	GND
3	Blue Input	11	GND
4	N.C	12	VGA_SDA
5	N.C	13	H-Sync
6	GND	14	V-Sync
7	GND	15	VGA_SCL
8	GND	16	GND

HDMI(19 pin Type A)

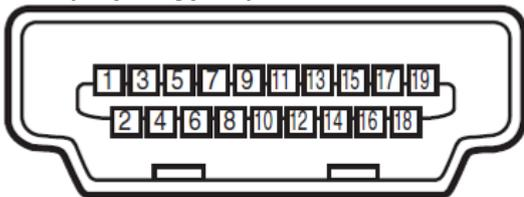

1	T.M.D.S. Data 2+ Input	11	Ground
2	Ground	12	T.M.D.S. Clock C- Input
3	T.M.D.S. Data 2- Input	13	CEC
4	T.M.D.S. Data 1+ Input	14	N.C
5	Ground	15	SCL
6	T.M.D.S. Data 1- Input	16	SDA
7	T.M.D.S. Data 0+ Input	17	Ground
8	Ground	18	P5V
9	T.M.D.S. Data 0- Input	19	HPD
10	T.M.D.S. Clock C+ Input		

Serial Control Terminal (RS-232, D-sub 9 pin)

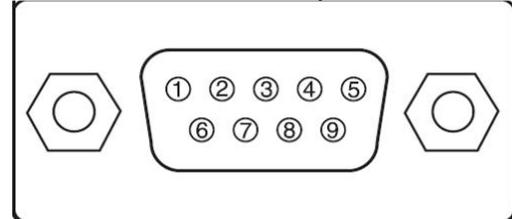

	Serial
1	N.C
2	RXD
3	TXD
4	N.C
5	Ground
6	N.C
7	Short with pin8
8	Short with pin7
9	N.C

Screen Trigger

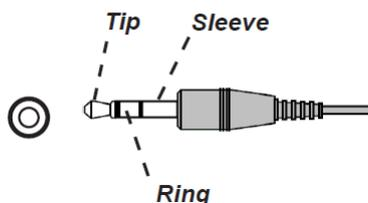

1	Tip	VCC(12V)
2	Sleeve-	Ground
3	Ring	Signal

Wired Remote

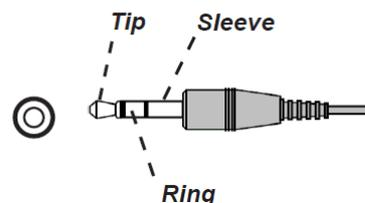

1	Tip	VCC(3.3V)
2	Sleeve-	Ground
3	Ring	Signal

HDBaseT/LAN Terminal (RJ-45)

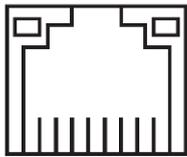

8 7 6 5 4 3 2 1

1	TX+
2	TX-
3	TXC
4	Ground
5	Ground
6	RXC
7	RX+
8	RX-

3D Sync Out

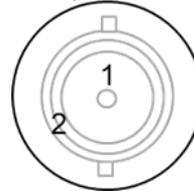

1	Signal
2	Ground

DU8190Z Lens Series

Eight types of optional electric lenses are available for the projector as below table. Contact the authorized dealer of Vivitek for details.

Part Number	Lens Name	F Number	Focal Length	Zoom Ratio	Screen Size	Throw Ratio
D88-UST01	Ultra Short Throw	2.0	5.64mm	---	100"-350"	0.377:1
D88-UWZ01	Ultra Wide Zoom	1.96-2.3	11.3-14.1mm	1.25:1	40"-500"	0.75-0.93:1
D88-WF18501	Wide Fix	1.85	11.6mm	---	40"-500"	0.76:1
D88-WZ01	Wide Zoom	1.85-2.5	18.7-26.5mm	1.41:1	40"-500"	1.25-1.79:1
D88-ST001	Standard Lens	1.7-1.9	26-34mm	1.3:1	40"-500"	1.73-2.27:1
D88-SMLZ01	Semi Long Zoom	1.86-2.48	32.9-54.2mm	1.65:1	40"-500"	2.22-3.67:1
D88-LOZ101	Long Zoom 1	1.85-2.41	52.8-79.1mm	1.5:1	40"-500"	3.58-5.38:1
D88-LOZ201	Long Zoom 2	1.85-2.48	78.5-121.9mm	1.55:1	40"-500"	5.31-8.26:1

- The best performance of above zoom lenses is within vertical shift 0-50%, horizontal shift $\pm 10\%$, the projector may support to wider adjustable shift range for flexibility in installation.
- D88-WF18501 and D88-UST01 are fixed lens, the vertical and horizontal shift range of the projection lenes are 0%, the corners of the projected image may appear shadows or distortion if lens is shifted horizontally or vertically.
- For best projection performance, support kits for D88-UST01 lens is required, please refer to the installation manual of D88-UST01 for the details.

Product Dimensions

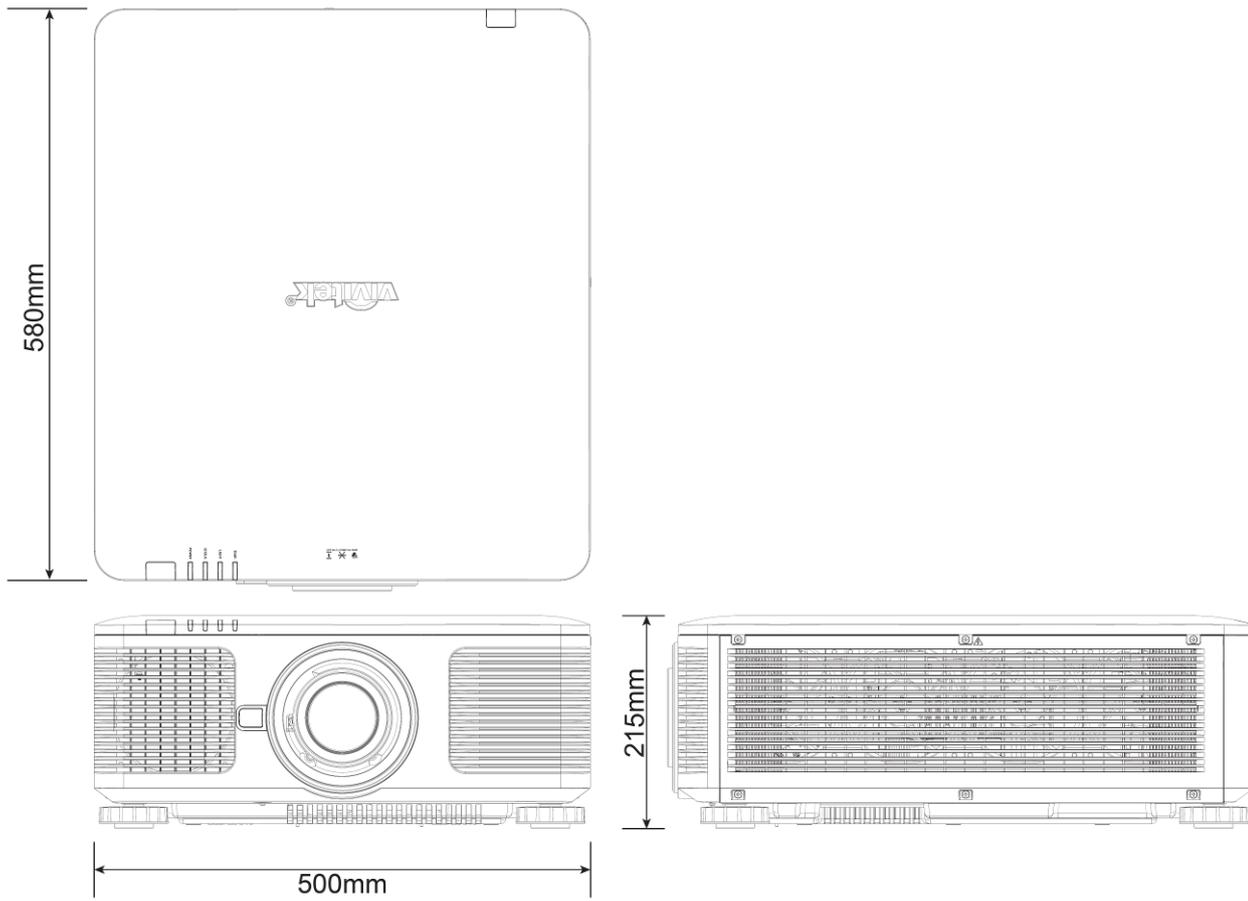

LED Indication

Several indicators messages are used to display the current projector status or alert the abnormal message.

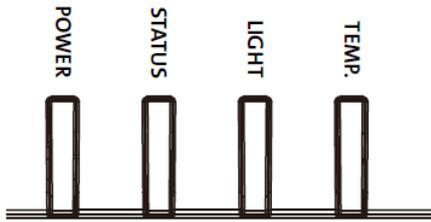

Power LED

LED Display		Projector status	Procedure
Off		AC Power is turned off	
Flashing	Green	Projector is turning on.	wait till projector start displaying
	Orange	Projector is under cooling	wait until cooling finish (~ 120 sec)
On	Red	Standby mode	
	Green	Projector is on	

Status LED

LED Display		Projector status	Procedure
Off		Normal status	
Flashing	Red (Cycles of 1)	Cover is opened.	Check if the top cabinet is installed properly.
	Red (Cycles of 4)	Cooling fan error	Contact with your nearest authorized dealer or service center.
On	Red	System Error	Contact with your nearest authorized dealer or service center.

Light Source LED

LED Display		Projector status	Procedure
Off		Light source is off	
Flashing	Green	Projector is turning on.	
	Red (Cycles of 6)	Light source lit fail	Contact with your nearest authorized dealer or service center.
On	Red	Light source is end-of-life	Contact with your nearest authorized dealer or service center.
	Green	Light source is on	

Temp LED

LED Display		Projector status	Procedure
Off		Normal status	
Flashing	Red	Over temperature error	Contact with your nearest authorized dealer or service center.

Common Problems and Solutions

These guidelines provide tips to deal with problems you may encounter while using the projector. If the problem remains unsolved, contact your dealer for assistance.

Often the problem is something as simple as a loose connection. Check the following before proceeding to the problem-specific solutions.

- Use some other electrical device to confirm that the electrical outlet is working.
- Ensure the projector is turned on.
- Ensure all connections are securely attached.
- Ensure the attached device is turned on.
- Ensure a connected PC is not in suspending mode.
- Ensure a connected notebook computer is configured for an external display. (This is usually done by pressing an Fn-key combination on the notebook.)

Tips for Troubleshooting

- In each problem-specific section, try the steps in the order suggested. This may help you to solve the problem more quickly.
- Try to pinpoint the problem to avoid replacing non-defective parts.
- For example, if you replace batteries and the problem remains, put the original batteries back and go to the next step.
- Keep a record of the steps you take when troubleshooting: The information may be useful when calling for technical support or for passing on to service personnel.

Image Problems

Problem: No image appears on the screen

1. Verify the settings on your notebook or desktop PC.
2. Turn off all equipment and power up again in the correct order.
3. Check if shutter is enabled.

Problem: The image is blurred

1. Adjust the Focus on the projector.
3. Performance Auto Sync on the remote control or projector.
4. Ensure the projection distance is within the specified range.
5. Check that if the projection lens is clean.

Problem: The image is wider at the top or bottom (trapezoid effect)

1. Position the projector so it is as perpendicular to the screen as possible.
2. Use the Keystone function to correct the problem.

Problem: The image is reversed or upside down

Check the Projection Mode setting on the CONTROL->Projection Mode menu.

Problem: The image is streaked

1. Set the Total dots (H Total) and VGA Setup settings on the INPUT menu of the OSD to the default settings.
2. To ensure the problem is not caused by a connected PC's video card, connect to another computer.

Problem: The image is flat with no contrast

1. Adjust the Contrast setting on the PICTURE menu of the OSD.
2. Adjust the Brightness setting on the PICTURE menu of the OSD.

Problem: The color of the projected image does not match the source image.

Adjust the Color temperature and Gamma settings on the PICTURE menu of the OSD.

Projection Problems

Problem: There is no light from the projector

1. Check that the power cable is securely connected.

2. Ensure the power source is good by testing with another electrical device.
3. Restart the projector in the correct order and check that the Power LED is green.
4. Check if Blank or Shutter function is enabled

Remote Control Problems

Problem: The projector does not respond to the remote control.

1. Direct the remote control towards remote sensor on the projector.
2. Ensure the path between remote and sensor is not obstructed.
3. Check the remote sensor on OSD is turned on.
4. Ensure remote control wire is not plugged in the projector.
5. Turn off any fluorescent lights in the room.
6. Check the battery polarity.
7. Replace the batteries.
8. Turn off other Infrared-enabled devices in the vicinity.
9. Have the remote control serviced.
10. Ensure that the remote control code conforms to the projector's code if universal remote control is used.
11. Check if Projector ID control is enabled and the ID number is correct.

Projection Lens Problems

Problem: The Zoom or Focus adjustment cannot work.

1. Check if the lens is installed properly, improper lens installation may cause to lens cannot work normally. Please follow the lens installation procedure to check again.
2. Check if Lens Lock function is enabled, locking the lens will disable all of lens adjustment functions.
3. Perform Center Lens function to calibrate the Lens again.
4. Replace the other lens to check the problem if the lens is available.
5. Contact with service center for the details.

Remote communication Problems

Problem: The projector does not respond to Ethernet control

1. Make sure Network Standby is turned on, the communication path is interrupted if it's turned off (less 0.5W)
2. Check the network configuration in your laptop and projector; refer to Remote Communication manual for more information.

Having the Projector Serviced

If you are unable to solve the problem, you should have the projector serviced. Pack the projector in the original carton. Include a description of the problem and a checklist of the steps you took when trying to fix the problem. The information may be useful to the service personnel. Return the projector to the place you purchased it.

About the Vivitek Support

If you cannot find solutions from this user guideline, please contact us using the contact information below:

North America

Vivitek Service Center
15700 Don Julian Road, Suite B
City of Industry, CA. 91745
U.S.A
Tel: 855-885-2378 (Toll-Free)
Email: T.services1@vivitekcorp.com
URL: www.vivitekusa.com

Europe and Africa

Vivitek Service & Support
Zandsteen 15
2132 MZ Hoofddorp
The Netherlands
Tel: +31 20 655 0960
Email: support@vivitek.eu
URL: www.vivitek.eu

China

Vivitek Service Center
201209, Room 1802, 18/F, Cimic Tower, No.1090, Century Avenue, Pudong, Shanghai
Tel: 400-888-3526 (Toll-Free)
Tel: 021-58360088-142 (Direct)
Email: service@vivitek.com.cn
URL: www.vivitek.com.cn

Asia and Taiwan

VIVITEK after-sales service
Vivitek Corporation, Co., Ltd.
4F., No.186, Ruiguang Rd., Neihu Dist., Taipei City 11491
TEL: 86-28-797-2088
FAX: 86-26-600-2358
E-mail: kenny.chang@vivitek.com.tw
URL: www.vivitek.com.tw

