

PA2 / PA9

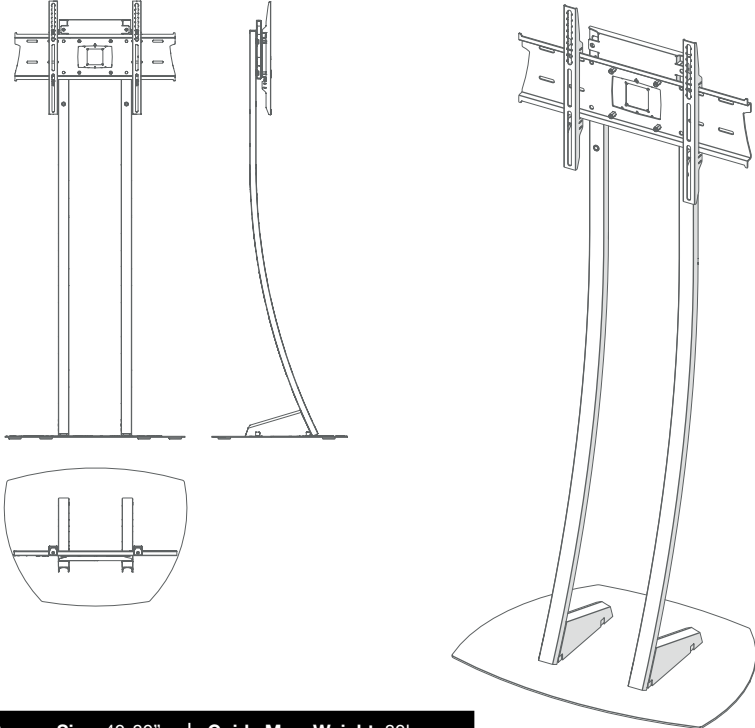

Screen Size: 40-80" | Guide Max. Weight: 80kg

Please check model specific details before installing

Revised 15/12/20

WARNING

Please carefully inspect the product before assembling. If you notice any apparent damage, call your carrier claims agent and do not continue the installation until it has been reviewed. Please watch for pinch points. Do not put your fingers between moveable parts. Do not tamper with or disassemble any spring loaded parts. Before installing, make sure that the supporting surface will support five times the combined load of the solution and the hardware. Never exceed the maximum load capacity. Please also layout all components to ensure that you have all of the required parts before proceeding (see BOM list on following page). Use of this product for anything other than its specified use may result in failure or personal injury. This product is intended for indoor use only. We recommend using a qualified trades person for installation. Use an assistant or lifting equipment to lift and position products.

For support, please call: +44 (0)1865 767676 or email: sales@unicol.com

#	TOOLS REQUIRED
1	8mm Allen Key
2	Pozi Head Screwdriver
3	17mm Spanner

INSTALLERS REQUIRED
1-2

COMPONENTS

#	DESCRIPTION	QTY
1	Parabella Base	1
2	C15230 Mounting Plate	1
3	Mount Back Plate	1
4	Mount Arms	2
5	Parabella Legs	2
6	M12x25 Button Head Screws	8
7	M10x20 Hex Head Screws	4

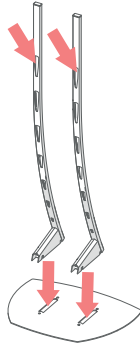

STEP 1

The unit is supplied with a power cable with a kettle plug & socket along its length. Use this to thread the cabling down the Parabella's legs and through the base.

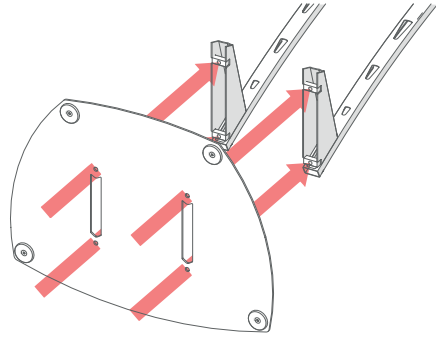

STEP 2

With legs laying on a flat surface (as shown above) pick up the base with the help of another person and offer the base to the mast. Ensure fixing holes are aligned and then secure.

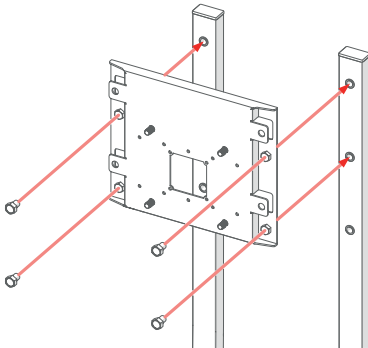

STEP 3

Fix the C15230 mounting plate to the top of the legs using M12x25 screws.

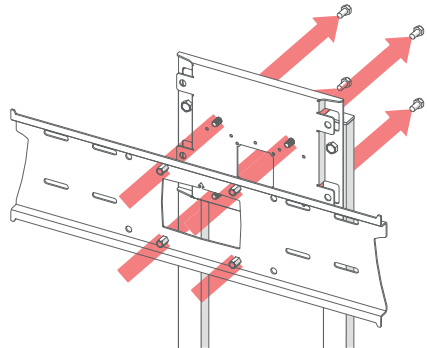

STEP 4

Line the back plate up with the mounting plate, as shown above. Fix 4 M10x20 screws from behind the mount adapter and into the 4 rivet nuts located on the back plate. Ensure back plate is secure and screws are tightened.

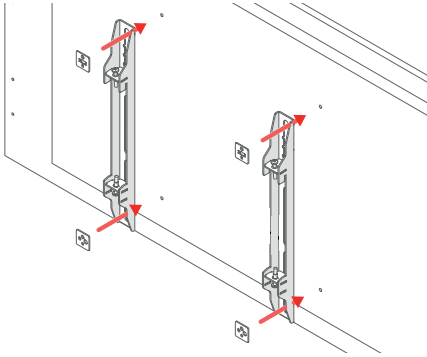

STEP 5

Utilising the tag locks and fixing pack provided with your mount, attach the arms to the back of your screen.

Ensure the arms are the correct way up before tightening - the 'hook' part of the arm should be at the top.

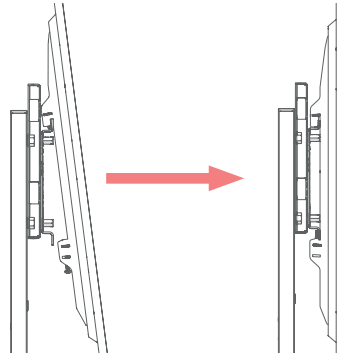

STEP 6

Using another team member, lift the screen up and gradually offer it up to the back plate. Gently tilting the screen forward, hook the arms over the lip of the back plate and lower once in position.

Centre the screen horizontally by sliding from side to side until you are happy with the position.

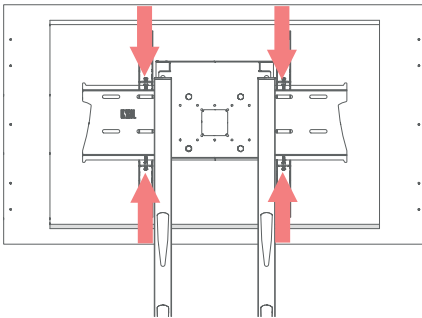

STEP 7

Once centered, ensure the bottom screws are not screwed tight and screw down the top screws to level the screen. Once level tighten bottom screws to secure the mount. ALT: If using tilting arms, this is when you can adjust them to suit.

Note that you won't be able to adjust the screens position after the screws have been tightened.

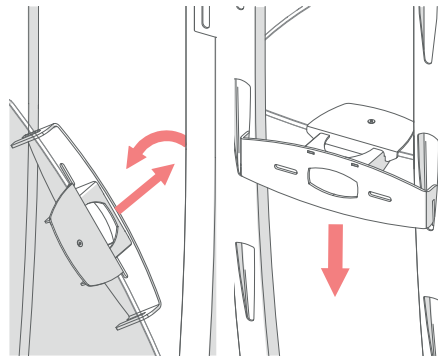

STEP 8 [OPTIONAL]

To fitting a shelf, angle it as you offer it up to the stand to allow the rear clips to fit between the legs. Level out and lower into position, ensuring both sides securely slot into place.