

Projector

PE506UL/ PE506WL

User's Manual

Please visit our web site for User's Manual in the latest version:
https://www.sharp-nec-displays.com/dl/en/pj_manual/lineup.html

Model No. NP-PE506UL/ NP-PE506WL

Trademarks

- AccuBlend and MultiPresenter are trademarks or registered trademarks of Sharp NEC Display Solutions, Ltd. in Japan, in the United States and other countries.
- Apple and Mac are trademarks of Apple Inc. registered in the U.S. and other countries.
- Microsoft and Windows are either a registered trademark or trademark of Microsoft Corporation in the United States and/or other countries.
- Micro Saver is a registered trademark of Kensington Computer Products Group, a division of ACCO Brands in the U.S. and other countries.
- The terms HDMI and HDMI High-Definition Multimedia Interface, and the HDMI Logo are trademarks or registered trademarks of HDMI Licensing Administrator, Inc. in the United States and other countries.



- PJLink trademark and logo are trademarks applied for registration or are already registered in Japan, the United States of America and other countries and areas.
- Blu-ray is a trademark of Blu-ray Disc Association.
- CRESTRON and ROOMVIEW are registered trademarks of Crestron Electronics, Inc. in the United States and other countries.
- Other product names and logos mentioned in this user's manual may be the trademarks or registered trademarks of their respective holders.
- GPL/LGPL Software Licenses

The product includes software licensed under GNU General Public License (GPL), GNU Lesser General Public License (LGPL), and others.

For more information on each software, see "readme.pdf" in the "about GPL&LGPL" folder on the supplied CD-ROM.

NOTES

- (1) The contents of this user's manual may not be reprinted in part or whole without permission.
- (2) The contents of this user's manual are subject to change without notice.
- (3) Great care has been taken in the preparation of this user's manual; however, should you notice any questionable points, errors or omissions, please contact us.
- (4) Notwithstanding article (3), NEC will not be responsible for any claims on loss of profit or other matters deemed to result from using the Projector.
- (5) This manual is commonly provided to all regions so they may contain descriptions that are pertinent for other countries.

Safety Cautions

Precautions

Please read this manual carefully before using your NEC projector and keep the manual handy for future reference.

CAUTION



To turn off main power, be sure to remove the plug from power outlet. The power outlet socket should be installed as near to the equipment as possible, and should be easily accessible.

CAUTION



TO PREVENT SHOCK, DO NOT OPEN THE CABINET. THERE ARE HIGH-VOLTAGE COMPONENTS INSIDE. REFER SERVICING TO QUALIFIED SERVICE PERSONNEL.



This symbol warns the user that uninsulated voltage within the unit may be sufficient to cause electrical shock. Therefore, it is dangerous to make any kind of contact with any part inside of the unit.



This symbol alerts the user that important information concerning the operation and maintenance of this unit has been provided. The information should be read carefully to avoid problems.

WARNING: TO PREVENT FIRE OR SHOCK, DO NOT EXPOSE THIS UNIT TO RAIN OR MOISTURE. DO NOT USE THIS UNIT'S PLUG WITH AN EXTENSION CORD OR IN AN OUTLET UNLESS ALL THE PRONGS CAN BE FULLY INSERTED.

Machine Noise Information Regulation - 3. GPSGV,

The highest sound pressure level is less than 70 dB (A) in accordance with EN ISO 7779.

CAUTION



Avoid displaying stationary images for a prolonged period of time. Doing so can result in these images being temporarily sustained on the surface of the LCD panel. If this should happen, continue to use your projector. The static background from previous images will disappear.

Disposing of your used product



In the European Union

EU-wide legislation as implemented in each Member State requires that used electrical and electronic products carrying the mark (left) must be disposed of separately from normal household waste. This includes projectors and their electrical accessories. When you dispose of such products, please follow the guidance of your local authority and/or ask the shop where you purchased the product.

After collecting the used products, they are reused and recycled in a proper way. This effort will help us reduce the wastes as well as the negative impact to the human health and the environment at the minimum level.

The mark on the electrical and electronic products only applies to the current European Union Member States.

Outside the European Union

If you wish to dispose of used electrical and electronic products outside the European union, please contact your local authority and ask for the correct method of disposal.



For EU: The crossed-out wheeled bin implies that used batteries should not be put to the general household waste! There is a separate collection system for used batteries, to allow proper treatment and recycling in accordance with legislation.

According to EU directive 2006/66/EC, the battery can't be disposed improperly. The battery shall be separated to collect by local service.

FCC Information (for USA only)

WARNING

- The Federal Communications Commission does not allow any modifications or changes to the unit EXCEPT those specified by Sharp NEC Display Solutions of America, Inc. in this manual. Failure to comply with this government regulation could void your right to operate this equipment.
- This equipment has been tested and found to comply with the limits for a class A digital device, pursuant to Part 15 of the FCC Rules. These limits are designed to provide reasonable protection against harmful interference when the equipment is operated in a commercial environment. This equipment generates, uses, and can radiate radio frequency energy and, if not installed and used in accordance with the instruction manual, may cause harmful interference to radio communications. Operation of this equipment in a residential area is likely to cause harmful interference in which case the user will be required to correct the interference at his own expense.

Supplier's declaration of conformity (for USA only)

This device complies with Part 15 of the FCC Rules. Operation is subject to the following two conditions.

(1) This device may not cause harmful interference, and (2) this device must accept any interference received, including interference that may cause undesired operation.

U.S.Responsible Party:	Sharp NEC Display Solutions of America, Inc.
Address:	3250 Lacey Rd, Ste 500 Downers Grove, IL 60515
Telephone Number:	630-467-3000
Type of Product:	Projector
Equipment Classification:	Class A Peripheral
Model Number:	NP-PE506UL/NP-PE506WL



For UK only: In UK, a BS approved power cord with moulded plug has a Black (five Amps) fuse installed for use with this equipment. If a power cord is not supplied with this equipment please contact your supplier.



(for Germany only)

Machine Noise Information Regulation - 3. GPSGV,

The highest sound pressure level is less than 70 dB (A) in accordance with EN ISO 7779.

Information of the AUDIO OUT mini jack

The AUDIO OUT mini jack does not support earphone/headphone terminal.

(For Customers in U.K.)

IMPORTANT

- The wires in this mains lead are coloured in accordance with the following code:

GREEN-AND-YELLOW:	“Earth”
BLUE:	“Neutral”
BROWN:	“Live”
- As the colours of the wires in the mains lead of this apparatus may not correspond with the coloured markings identifying the terminals in your plug proceed as follows:
 - The wire which is coloured GREEN-AND-YELLOW must be connected to the terminal in the plug which is marked by the letter **E** or by the safety earth symbol  or coloured green or green-and-yellow.
 - The wire which is coloured BLUE must be connected to the terminal which is marked with the letter **N** or coloured black.
 - The wire which is coloured BROWN must be connected to the terminal which is marked with the letter **L** or coloured red.
- Ensure that your equipment is connected correctly. If you are in any doubt consult a qualified electrician.

“WARNING: THIS APPARATUS MUST BE EARTHED.”

Important Safeguards

These safety instructions are to ensure the long life of your projector and to prevent fire and shock. Please read them carefully and heed all warnings.

Installation

- Do not place the projector in the following conditions:
 - on an unstable cart, stand, or table.
 - near water, baths, or damp rooms.
 - in direct sunlight, near heaters, or heat radiating appliances.
 - in a dusty, smoky or steamy environment.
 - on a sheet of paper or cloth, rugs or carpets.
- Avoid locations with extremes of temperature and humidity.
The usage environment of this projector is as follows.
 - The operating temperature: 0° to 40°C (32° to 104° F) / humidity: 20 to 80% (with no condensation)
 - The storage temperature: -10°C to 50°C (14 to 122°F) / humidity: 20 to 80% (with no condensation)
- If you wish to have the projector installed on the ceiling:
 - Do not attempt to install the projector yourself.
 - The projector must be installed by qualified technicians in order to ensure proper operation and reduce the risk of bodily injury.
 - In addition, the ceiling must be strong enough to support the projector and the installation must be in accordance with any local building codes.
 - Please consult your dealer for more information.
- Do not install and store the projector in the below circumstances. Failure to do so may cause of malfunction.
 - In powerful magnetic fields
 - In corrosive gas environment
 - Outdoors
- If intense light like laser beams enters from the lens, it could lead to malfunction.

CAUTION



This equipment is designed to be used in the condition of the power cord connected to earth. If the power cord is not connected to the earth, it may cause electric shock. Please make sure the power cord is earthed properly.
Do not use a 2-core plug converter adapter.

Cable information

CAUTION



Use shielded cables or cables attached ferrite cores so as not to interfere with radio and television reception. For details, please refer to "Making Connections" in this user's manual.

Notice Concerning Electromagnetic Interference (EMI)

WARNING:

Operation of this equipment in a residential environment could cause radio interference.

WARNING

- Operation of this equipment in a residential environment could cause radio interference.
- Do not cover the lens with the lens cap or equivalent while the projector is on. Doing so can lead to melting of the cap due to the heat emitted from the light output.
- Do not place any objects, which are easily affected by heat, in front of the projection lens. Doing so could lead to the object melting from the heat that is emitted from the light output.

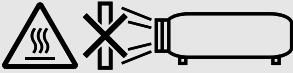

- Do not use a spray containing flammable gas to get rid of accumulated dust and dirt on the filter and the projection window. It may cause of fire.

⚠ Fire and Shock Precautions ⚠

- Ensure that there is sufficient ventilation and that vents are unobstructed to prevent the build-up of heat inside your projector. Allow at least 4 inches (10 cm) of space between your projector and a wall.
- Prevent foreign objects such as paper clips and bits of paper from falling into your projector. Do not attempt to retrieve any objects that might fall into your projector. Do not insert any metal objects such as a wire or screwdriver into your projector. If something should fall into your projector, disconnect it immediately and have the object removed by a qualified service personnel.
- Do not place any objects on top of the projector.
- Do not touch the power plug during a thunderstorm. Doing so can cause electrical shock or fire.
- The projector is designed to operate on a power supply of 100-240V AC 50/60 Hz. Ensure that your power supply fits this requirement before attempting to use your projector.
- About the projector's light source
 - Do not look into the projector's lens.
Strong light that could damage your eyes is projected when the projector is operating. Be especially careful when children are around.
 - Do not look at the projected light using optical devices (magnifying glasses, reflectors, etc.). Doing so could result in vision impairment.
 - Check that there is no one looking at the lens within the projection range before turning on the projector.
 - Do not allow children to operate the projector alone. When a child is operating the projector an adult should always be present and watch the child carefully.
- The below pictogram, that is indicated near the lens on the cabinet, describes this projector is categorized in the risk group 2 of IEC 62471-5:2015. As with any bright light source, do not stare into the beam, RG2 IEC 62471-5:2015.

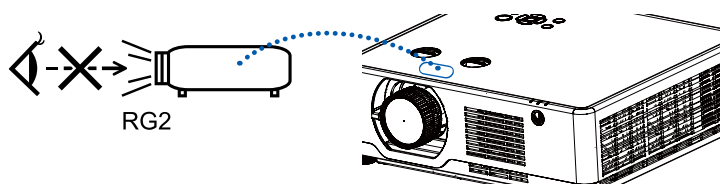

- Keep any items such as magnifying glass out of the light path of the projector. The light being projected from the lens is extensive, therefore any kind of abnormal objects that can redirect light coming out of the lens, can cause unpredictable outcome such as fire or injury to the eyes.
- Do not place any objects, which are easily affected by heat, in front of a projector exhaust vent. Doing so could lead to the object melting or getting your hands burned from the heat that is emitted from the exhaust.
- Do not splash water over the projector. Doing so can cause electrical shock or fire. If the projector gets wet, turn off the projector, unplug the power cord and have the projector serviced by a qualified service personnel.
- Handle the power cord carefully. A damaged or frayed power cord can cause electric shock or fire.
 - Do not use any power cord other than the one supplied with the projector.
 - Do not bend or tug the power cord excessively.
 - Do not place the power cord under the projector, or any heavy object.
 - Do not cover the power cord with other soft materials such as rugs.

- Do not heat the power cord.
- Do not handle the power plug with wet hands.
- Turn off the projector, unplug the power cord and have the projector serviced by a qualified service personnel under the following conditions:
 - When the power cord or plug is damaged or frayed.
 - If liquid has been spilled into the projector, or if it has been exposed to rain or water.
 - If the projector does not operate normally when you follow the instructions described in this user's manual.
 - If the projector has been dropped or the cabinet has been damaged.
 - If the projector exhibits a distinct change in performance, indicating a need for service.
- Disconnect the power cord and any other cables before carrying the projector.
- Turn off the projector and unplug the power cord before cleaning the cabinet.
- Turn off the projector and unplug the power cord if the projector is not to be used for an extended period of time.
- When using a LAN cable:
 - For safety, do not connect to the terminal for peripheral device wiring that might have excessive voltage.
- Lens shift, focus and zoom operations.
 - When shifting the lens or adjusting the focus or zoom, do so from either behind or to the side of the projector. If these operations are performed from the front, your eyes could be exposed to strong light and get injured..
 - Keep your hands away from the lens area when performing the lens shift operation. If not, your fingers could get caught in the cap between the cabinet and the lens.

CAUTION

- Do not use the adjustable tilt foot for purposes other than originally intended. Misuses such as gripping the tilt-foot or hanging on the wall can cause damage to the projector.
- Do not turn off the AC power for 60 seconds after the light source is turned on and while the POWER indicator is blinking blue. Doing so could cause premature Light failure.

Remote Control Precautions

- Handle the remote control carefully.
- If the remote control gets wet, wipe it dry immediately.
- Avoid excessive heat and humidity.
- Do not short, heat, or take apart batteries.
- Do not throw batteries into fire.
- If you will not be using the remote control for a long time, remove the batteries.
- Ensure that you have the batteries' polarity (+/-) aligned correctly.
- Do not use new and old batteries together, or use different types of batteries together.
- Dispose of used batteries according to your local regulations.

Laser Safety Caution



WARNING

CLASS 1 OF IEC 60825-1 THIRD EDITION LASER PRODUCT

- The laser module is equipped in this product. Use of controls or adjustments of procedures other than those specified herein may result in hazardous radiation exposure.

For USA

COMPLIES WITH 21 CFR 1040.10 AND 1040.11 EXCEPT FOR CONFORMANCE AS A RISK GROUP 2 LIP AS DEFINED IN IEC 62471-5:ED.1.0. FOR MORE INFORMATION SEE LASER NOTICE 57, DATED May 08, 2019.

For other regions (including USA)

This product is classified as Class 1 of IEC 60825-1 Third edition 2014-05 and RG2 of IEC 62471-5 First edition 2015-06.

- Obey the laws and regulations of your country in relation to the installation and management of the device.
- Outline of laser emitted from the built-in light module:
Wave length: 449-461nm
Maximum power: 105W
- Radiation pattern from the protective housing:
Wave length: 449-461nm
Maximum laser radiation output: 66.6mW

The laser module is equipped in this product. Use of controls or adjustments of procedures other than those specified herein may result in hazardous radiation exposure.

Light Module

- A light module containing multiple laser diodes is equipped in the product as the light source.
- These laser diodes are sealed in the light module. No maintenance or service is required for the performance of the light module.
- End user is not allowed to replace the light module.
- Contact qualified distributor for light module replacement and further information.

- This product is classified as CLASS 1 LASER PRODUCT -RISK GROUP 2 of IEC60825-1: 2014 and also complies with 21 CFR 1040.10 and 1040.11 as a Risk Group 2, LIP (Laser Illuminated Projector). as defined in IEC 62471:5:Ed. 1.0. For more information see Laser Notice No. 57, dated May 8, 2019.
- As with any bright source, do not stare into the direct beam, RG2 IEC 62471-5:2015.

Label 1 FDA additional warning label (For USA only)

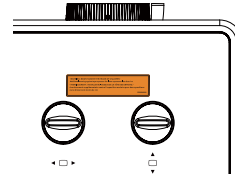

- Outline of laser emitted from the built-in light module:
 - Wave length: 449-461nm
 - Maximum power: 105W
- The laser module is equipped in this product Use of controls or adjustments of procedures other than those specified herein may result in hazardous radiation exposure.
- Additional instructions to supervise children, no staring, and not use optical aids.
- Notice is given to supervise children and to never allow them to stare into the projector beam at any distance from the projector.
- Notice is given to use caution when using the remote control for starting the projector while in front of the projection lens.
- Notice is given to the user to avoid the use of optical aids such as binoculars or telescopes inside the beam.
- When turning on the projector, make sure no one within projection range is looking at the lens.
- Keep any items (magnifying glass etc.) out of the light path of the projector. The light path being projected from the lens is extensive, therefore any kind of abnormal objects that can redirect light coming out of the lens. can cause an unpredictable outcome such as a fire or injury to the eyes.
- The use of a ceiling mount is recommended with this product to place it above the eyes of children.
- Any operation or adjustment not specifically instructed by the user's guide creates the risk of hazardous radiation.

Label 2 Class 1 laser product label (For other regions)



For USA

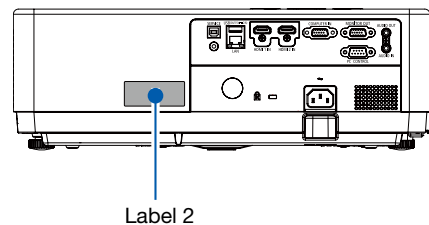

For other regions

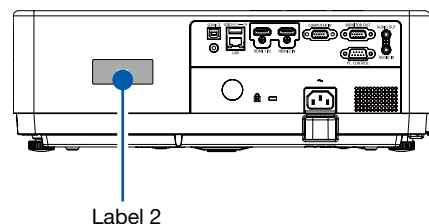

Laser light radiation range

The figure below shows the maximum radiation range of the laser light.

Horizontal angle (unit: degree)

Zoom	Lens position		
	Right most	Center (Reference value)	Left most
	HR	HC	HL
Wide	33.0	22.3	33.0
Tele	21.8	14.2	21.8

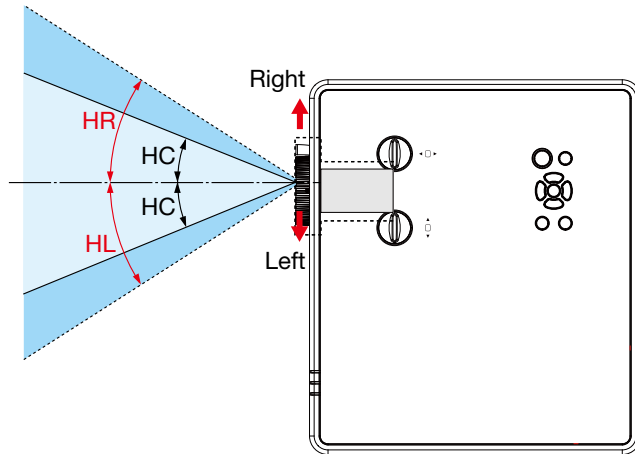

Zoom	Lens position	
	Upper most	Center (Reference value)
	VU	VC
Wide	29.5	14.4
Tele	19.2	9.0

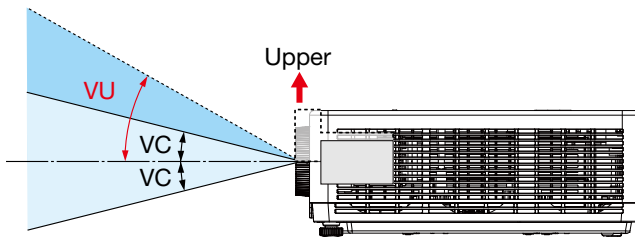

About High Altitude mode

- Set [High altitude] to [ON] in the Setting menu when using the projector at altitudes approximately 1700 meters or higher. Using the projector at an altitude of about 1700 meters or more without setting [High altitude] to [ON] can cause the projector to overheat and shut down the protector.
- Using the projector at altitudes approximately 1700 meters or higher can shorten the life of optical components such as the light module.
- When the projector is at altitudes approximately 1700 meters or higher, it will switch from [OFF] to [ON] automatically.

Clearance for Installing the Projector

When installing the projector, keep sufficient space around it, as described below. If not, the hot exhaust emitted from the projector may be taken back in.

Also, make sure no wind from an air-conditioner hits the projector. The projector's heat control system may detect an abnormality (temperature error) and automatically shut off the power.

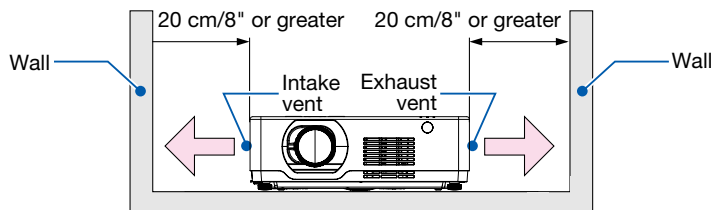

NOTE:

In the above figure, it is assumed that there is sufficient space above the projector. There is also an intake vent in the front. Leave about 10 cm or more space behind, and even more space for installing the cables.

Precautions for Ceiling Installation

Do not install the projector in the following places. Attached substances such as oil, chemicals and moisture may cause deformation or cracks of the cabinet, corrosion of the metal parts, or malfunction.

- Outdoors and places with humid or dust.
- Places exposed to oil smoke or steam.
- Places where corrosive gases are generated.

About Copyright of original projected pictures:

Please note that using this projector for the purpose of commercial gain or the attraction of public attention in a venue such as a coffee shop or hotel and employing compression or expansion of the screen image with the following functions may raise concern about the infringement of copyrights which are protected by copyright law.

[ASPECT], [KEYSTONE], Magnifying feature and other similar features.

Turkish WEEE information relevant for Turkish market

AEEE Yönetmeliğine Uygundur.

This device is not intended for use in the direct field of view at visual display workplaces. To avoid incommoding reflections at visual display workplaces this device must not be placed in the direct field of view.

Power management function

The projector has power management functions. To reduce power consumption, the power management functions (1 and 2) are factory preset as shown below. To control the projector from an external device via serial cable connection, use the on-screen menu to change the settings for 1 and 2.

1. STANDBY MODE (Factory preset: NORMAL)

To control the projector from an external device, select [NETWORK STANDBY] or [SLEEP] for [STANDBY MODE].

NOTE:

- When [NORMAL] is selected for [STANDBY MODE], the following terminals and functions will not work: MONITOR OUT terminal, AUDIO OUT terminal, LAN functions. Please refer to page 39 about details.

2. Power management (Factory preset: Ready)

To control the projector from an external device, select [OFF] for [Power management].

NOTE:

- When [5 Min] is selected for [Timer], you can enable the projector to automatically turn off in 5 Min if there is no signal received by any input or if no operation is performed.

360° projection function

Our projector support 360° projection.

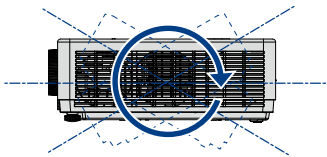

Vertical 360°

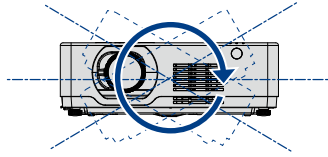

Horizontal 360°



Vertical & Horizontal 360°

Important Information	I
1. Introduction	1
1 What's in the Box?	1
2 Introduction to the Projector	2
About this user's manual	2
3 Part Names of the Projector.....	3
Front/Top	3
Rear	4
Top Features.....	5
Terminal Panel Features	6
4 Part Names of the Remote Control	7
Battery Installation	8
Remote Control Precautions	8
Operating Range for Wireless Remote Control	8
Angle sensor.....	9
2. Projecting an Image (Basic Operation)	10
1 Flow of Projecting an Image.....	10
2 Connecting Your Computer/Connecting the Power Cord	11
3 Turning on the Projector.....	12
4 Change the On-Screen menu language.....	13
5 Selecting a Source	14
Selecting the computer source.....	14
6 Adjusting the Picture Size and Position	15
Adjust the Tilt Foot.....	16
Zoom.....	17
Focus.....	17
Lens shift	18
7 Correcting Keystone Distortion [KEYSTONE]	20
8 Optimizing Computer Signal Automatically	22
Adjusting the Image Using Auto Adjust.....	22
9 Turning Up or Down Volume	22
10 Turning off the Projector	23
11 When Moving the Projector.....	24
3. Convenient Features	25
1 Turning off the Image and Sound.....	25
2 Freezing a Picture.....	25
3 Magnifying a Picture.....	25
4. Using the VIEWER	27
USB-A function	27
5. Using On-Screen Menu	29
1 Menu item overview	29
2 List of Menu Items.....	30

3	Menu Descriptions & Functions [INPUT]	33
	Computer	33
	HDMI1 and HDMI2	33
	USB-A	33
	LAN	33
4	Menu Descriptions & Functions [Display menu]	34
	[Auto PC adj.]	34
	[Fine sync]	34
	[H position]	34
	[V position]	35
	[H. size]	35
	[Aspect]	35
	[Orientation]	36
	[Menu position]	36
	[Background display]	37
	[Signal format]	37
5	Menu Descriptions & Functions [Color adjust]	38
	[Image mode]	38
	[Contrast]	39
	[Brightness]	39
	[Color temp.]	39
	[Red]	39
	[Green]	39
	[Blue]	39
	[Sharpness]	39
6	Menu Descriptions & Functions [Setting]	40
	[On start]	40
	[Standby mode]	41
	[High altitude]	41
	[Cooling fast]	42
	[Key lock]	42
	[Contrast optimization]	43
	[Baud rate]	43
	[Laser control]	44
	[Sound]	45
	[HDMI setup]	45
7	Menu Descriptions & Functions [Expand]	46
	[Language]	46
	[Auto setup]	47
	[Keystone]	48
	[Security]	51
	[Power management]	52
	[Filter]	53
	[Test pattern]	53
	[Network setup]	54
	[Control ID]	55
	[Factory default]	56
8	Menu Descriptions & Functions [USB-A]	56
	[Set slide]	57
	[Slide transition effect]	57
	[Sort order]	57
	[Rotate]	57
	[Best fit]	57

[Repeat].....	58
[Apply].....	58
9 Menu Descriptions & Functions [Info.]	59
6. Network control	60
1 Network control operation.....	60
2 Enter through a Web browser	61
Connecting Your Computer.....	61
3 [System status] page.....	62
4 [General setup] page.....	62
5 [Picture setup] page	62
6 [Image setup] page.....	63
7 [Network setup] page.....	64
7. Installation and Connections	65
1 Setting Up the Screen and the Projector	65
Tables of screen sizes and dimensions.....	67
Example of installation on a desktop.....	68
Lens shift range	70
2 Making Connections	72
Connecting Your Computer.....	72
Cautions when using a DVI signal	73
Connecting an External Monitor.....	74
Connecting Component Input	75
Connecting HDMI Input.....	76
Connecting to a Wired LAN.....	77
Connecting to a Wireless LAN.....	77
8. Connecting with MultiPresenter app.....	80
1 Things you can do by connecting the projector with MultiPresenter app	80
2 Connecting to MultiPresenter	81
9. Maintenance	82
1 Cleaning the Filter	82
2 Cleaning the Lens.....	84
3 Cleaning the Cabinet.....	84
10. Appendix.....	85
1 Troubleshooting	85
Common Problems & Solutions	85
If there is no picture, or the picture is not displayed correctly.	86
Feature of each indicator.....	87
Indicator Message (Status message)	87
Indicator Message (Error message).....	88
2 Specifications.....	90
3 Cabinet Dimensions	92
4 Pin Assignments of D-Sub COMPUTER Input Terminal.....	94
5 Compatible Input Signal List.....	95

Table of Contents

6	PC Control Codes and Cable Connection	96
7	Troubleshooting Check List	98
8	REGISTER YOUR PROJECTOR! (for residents in the United States, Canada, and Mexico)	100

1. Introduction

① What's in the Box?

Make sure your box contains everything listed. If any pieces are missing, contact your dealer. Please save the original box and packing materials if you ever need to ship your projector.

Projector

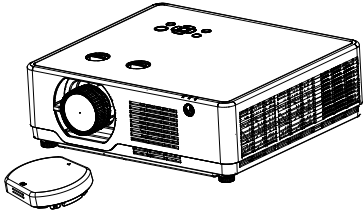

Lens cap × 1
(440165301)
(Only for PE506UL)

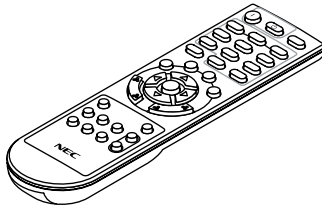

Remote control
(393004710)

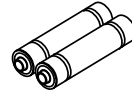

Batteries (AAA × 2)
(391003200)

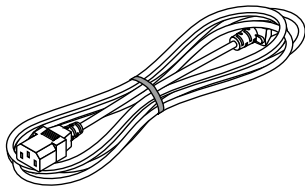

Power cord
(US: 310004900)
(EU: 310003100)

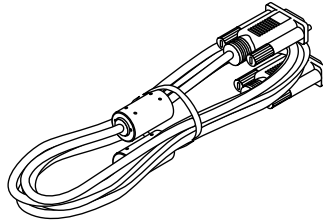

Computer cable (VGA)
(310002200)

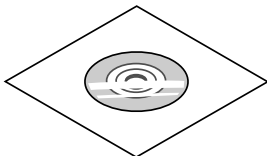

NEC Projector CD-ROM
User's manual (PDF)
(510054501)

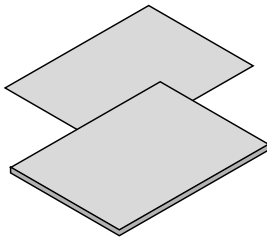

- Important Information (510054601)
- Quick Setup Guide
(For North America: 510054801)
(For Other countries than North America: 510054700 and 510054801)

For North America only
Limited warranty

For customers in Europe:
You will find our current valid Guarantee Policy on our Web Site:
<https://www.sharpnecdisplays.eu>

Unless otherwise described in the user's manual, the drawings for the projector cabinet show examples of the PE506UL.

② Introduction to the Projector

This section introduces you to your new projector and describes the features and controls.

- **Support High Resolution Signal**

The projector has the Multi-scan system to conform to many output signals. Up to WUXGA (COMPUTER), 4K@30Hz (HDMI).

- **Useful Functions for Presentations**

The digital zoom function allows you to focus on the crucial information during a presentation.

- **Light source • Brightness**

- A long-life laser diode is equipped in the light module.

The product can be operated at low cost because the laser light source can be used for a long time without replacement or maintenance.

- Brightness can be adjusted

Unlike with ordinary light source, the brightness can be adjusted from 50 to 100% when Normal mode.

- **Multi-language Menu Display**

The screen menu of the projector is available in 27 languages: English, German, French, Italian, Spanish, Polish, Swedish, Dutch, Portuguese, Japanese, Simplified Chinese, Traditional Chinese, Korean, Russian, Arabic, Turkish, Finnish, Norwegian, Danish, Indonesian, Hungarian, Czech, Kazakh, Vietnamese, Thai, Farsi, Romania.

- **Convenient Maintenance Functions**

Filter maintenance functions provide for better and proper maintenance of the projector.

- **Security Function**

The Security function helps you to ensure security of the projector. With the Key lock function, you can lock the operation on the control panel. PIN code lock function prevents unauthorized use of the projector.

- **Color board Function**

At the time of simple projection on the colored wall, you can get the close color image to the color image projected on a white screen by selecting the similar color to the wall color from the preset four colors.

- **Energy-saving**

The Power management function reduces power consumption and maintains the light source life.

- Lot6, Lot26 supported with energy saving technology.

Select [Standby mode] supports Lot6, Select [Network Standby] supports Lot26.

- [ECO MODE] for low power consumption and [CARBON METER] display.

The projector has ECO MODE to refrain power consumption. Furthermore, the power-saving effect when the [ECO MODE] is set is converted into the amount of reductions of CO2 emissions and this is indicated on the confirmation message displayed on-screen menu [CARBON METER].

- **Network**

- CRESTRON ROOMVIEW compatibility

- Support the "MultiPresenter" Function.

About this user's manual

The fastest way to get started is to take your time and do everything right the first time. Take a few minutes now to review the user's manual. This may save you time later on. At the beginning of each section of the manual you'll find an overview. If the section doesn't apply, you can skip it.

3 Part Names of the Projector

Front/Top

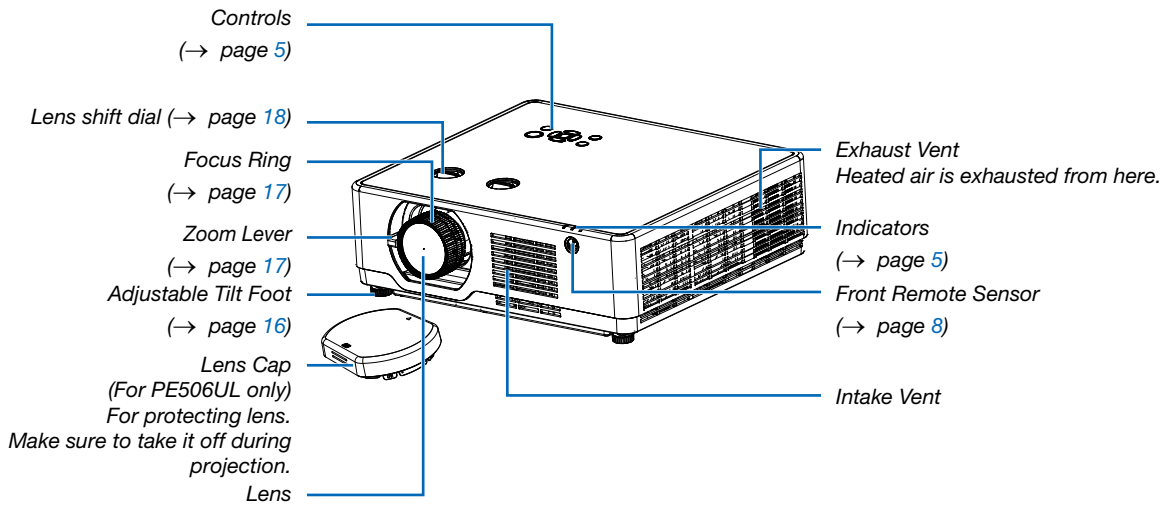

Rear

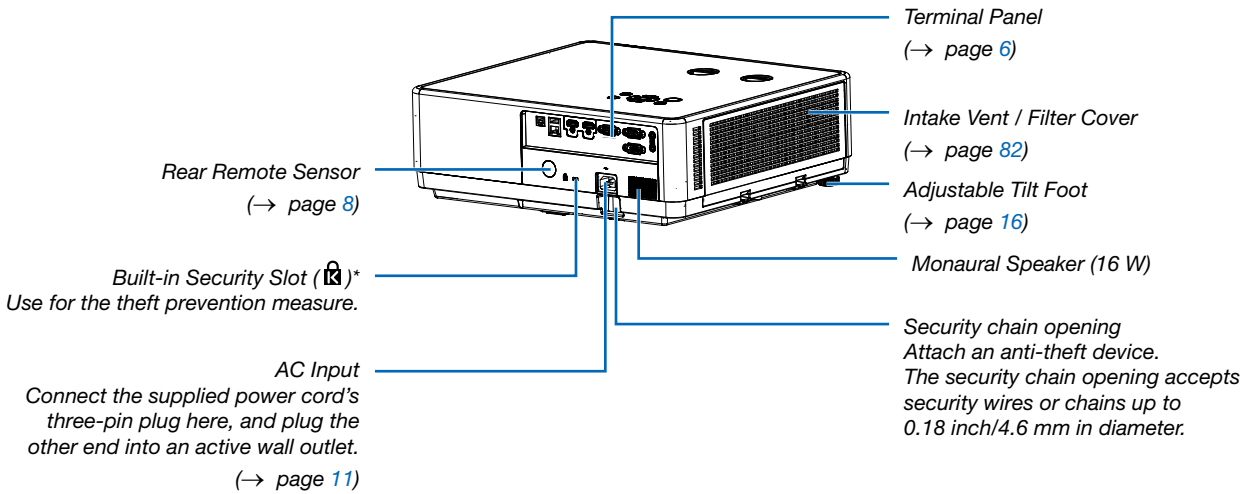

* This security slot supports the Micro Saver[®] Security System.

NOTE:

- Security and theft protection lock compatible with Kensington security cables/equipment. For products, visit Kensington's website.

Top Features

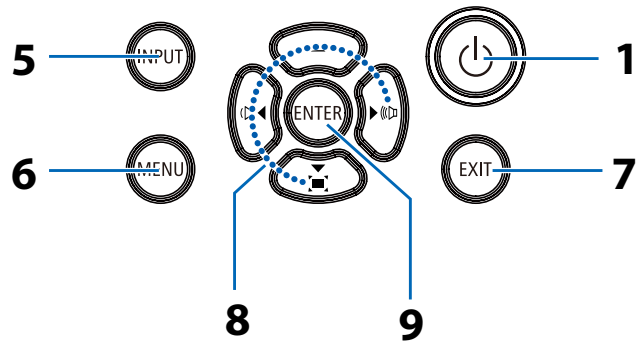
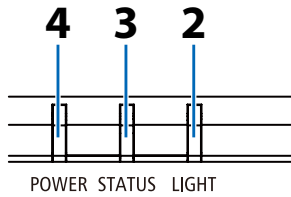

1. **⏻ (POWER) Button**
(→ page 12, 23)
2. **LIGHT Indicator**
(→ page 87)
3. **STATUS Indicator**
(→ page 87)
4. **POWER Indicator**
(→ page 12, 23, 24, 87)
5. **INPUT Button**
(→ page 14)
6. **MENU Button**
(→ page 29)
7. **EXIT Button**
8. **▲▼◀▶ / Volume Buttons ◀▶ / Keystone Button ▼**
(→ page 20, 22)
9. **ENTER Button**

Terminal Panel Features

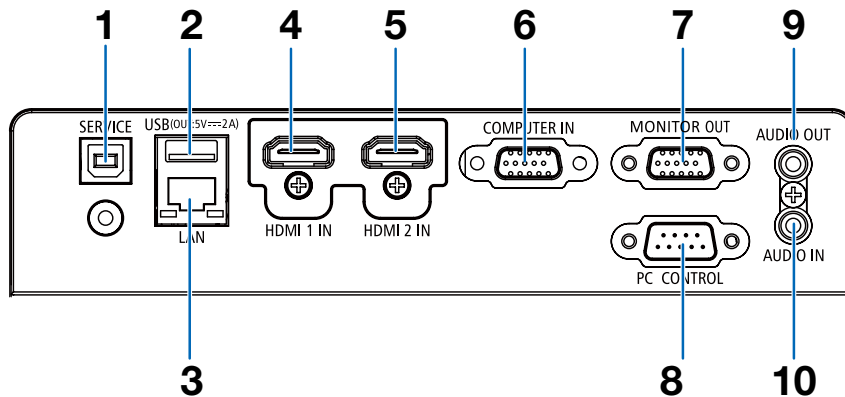
**1. SERVICE Port (USB Type B)**

(for service purpose only)

2. USB Port (Type A)

For USB memory

(→ page 27)

3. LAN Port (RJ-45)

(→ page 77)

4. HDMI 1 IN Terminal (Type A)

(→ page 72, 73, 76)

5. HDMI 2 IN Terminal (Type A)

(→ page 72, 73, 76)

6. COMPUTER IN/ Component Input Terminal (Mini D-Sub 15 Pin)

(→ page 11, 72, 75)

7. MONITOR OUT Terminal (Mini D-Sub 15 Pin)

(→ page 74)

8. PC CONTROL Port (D-Sub 9 Pin)

(→ page 96)

Use this port to connect a PC or control system. This enables you to control the projector using serial communication protocol. If you are writing your own program, typical PC control codes are on page 96.

9. AUDIO OUT Mini Jack (Stereo Mini)

(→ page 74)

NOTE: The AUDIO OUT mini jack does not support earphone/headphone terminal.

10. AUDIO IN Mini Jack (Stereo Mini)

(→ page 75)

4 Part Names of the Remote Control

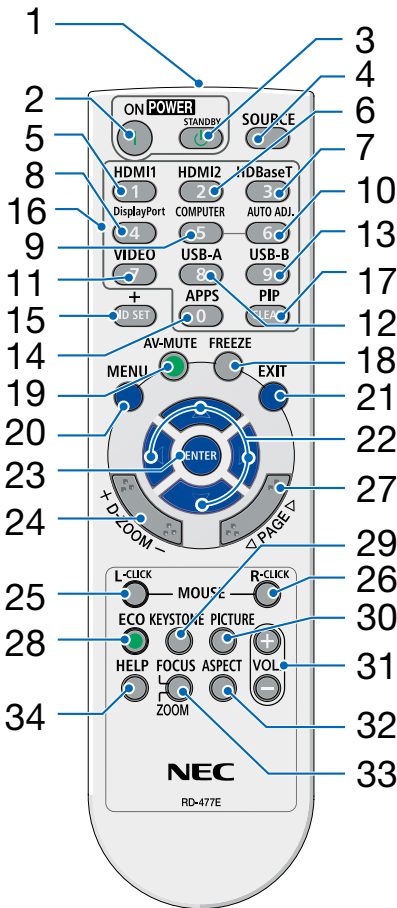

1. **Infrared Transmitter**
(→ page 8)
2. **(|) POWER ON Button**
(→ page 12)
3. **(⏻) POWER STANDBY Button**
(→ page 23)
4. **SOURCE Button**
(→ page 14)
5. **HDMI 1 Button**
(→ page 14)
6. **HDMI 2 Button**
(→ page 14)
7. **HDBaseT Button**
(This button does not work on this series of projectors)
8. **DisplayPort Button**
(This button does not work on this series of projectors)
9. **COMPUTER Button**
(→ page 14)
10. **AUTO ADJ. Button**
(→ page 22)
11. **VIDEO Button**
(This button does not work on this series of projectors)
12. **USB-A Button**
(→ page 14, 27)
13. **USB-B Button**
(This button does not work on this series of projectors)
14. **APPS Button**
(→ page 14, 80)
15. **ID SET Button**
(→ page 55)
16. **Numeric Keypad Button/CLEAR Button**
(→ page 55)
17. **PIP Button**
(PIP button does not work on this series of projectors)
18. **FREEZE Button**
(→ page 25)
19. **AV-MUTE Button**
(→ page 25)
20. **MENU Button**
(→ page 29)
21. **EXIT Button**
22. **▲▼◀▶ Button**
23. **ENTER Button**
24. **D-ZOOM (+)(-) Button**
(→ page 25, 26)
25. **MOUSE L-CLICK Button***
(This button does not work on this series of projectors)
26. **MOUSE R-CLICK Button***
(This button does not work on this series of projectors)
27. **PAGE ▽/△ Button**
(This button does not work on this series of projectors)
28. **ECO Button**
(→ page 44)
29. **KEYSTONE Button**
(→ page 20, 48)
30. **PICTURE Button**
(→ page 38)
31. **VOL. (+)(-) Button**
(→ page 22)
32. **ASPECT Button**
(→ page 35)
33. **FOCUS/ZOOM Button**
(This button does not work on this series of projectors)
34. **HELP Button**
(→ page 59)

Battery Installation

1. Press firmly and slide the battery cover off.

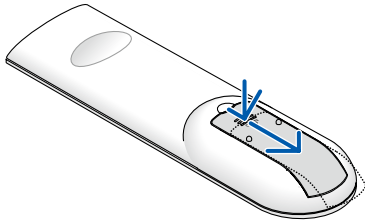

2. Install new batteries (AAA). Ensure that you have the batteries' polarity (+/-) aligned correctly.

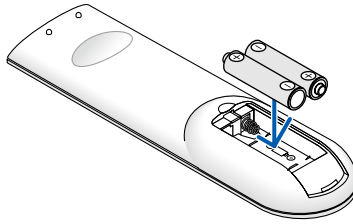

3. Slip the cover back over the batteries until it snaps into place. Do not mix different types of batteries or new and old batteries.

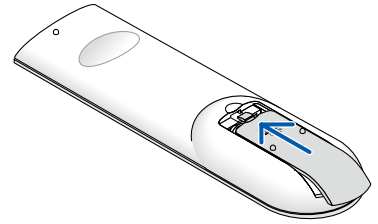

Remote Control Precautions

- Handle the remote control carefully.
- If the remote control gets wet, wipe it dry immediately.
- Avoid excessive heat and humidity.
- Do not short, heat, or take apart batteries.
- Do not throw batteries into fire.
- If you will not be using the remote control for a long time, remove the batteries.
- Ensure that you have the batteries' polarity (+/-) aligned correctly.
- Do not use new and old batteries together, or use different types of batteries together.
- Dispose of used batteries according to your local regulations.

Operating Range for Wireless Remote Control

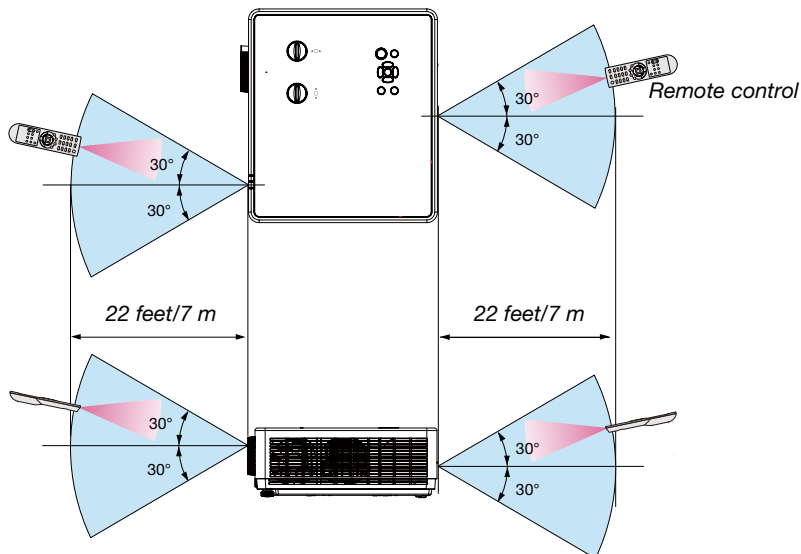

- The infrared signal operates by line-of-sight up to a distance of about 22 feet/7 m and within a 30-degree angle of the remote sensor on the projector cabinet.
- The projector will not respond if there are objects between the remote control and the sensor, or if strong light falls on the sensor. Weak batteries will also prevent the remote control from properly operating the projector.

Angle sensor

The installation angle range that the built-in angle sensor of the projector can detect is shown in the figure below.

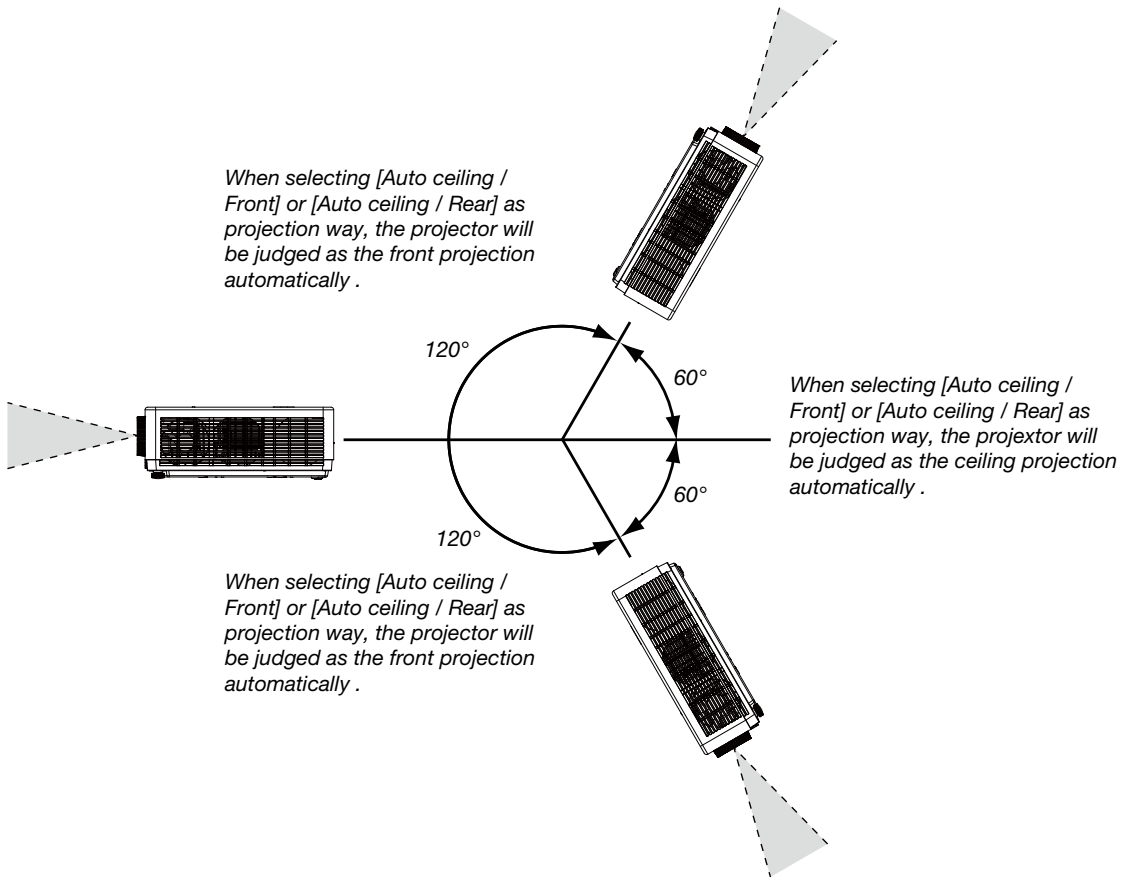

2. Projecting an Image (Basic Operation)

This section describes how to turn on the projector and to project a picture onto the screen.

① Flow of Projecting an Image

Step 1

- *Connecting your computer / Connecting the power cord (→ page 11)*



Step 2

- *Turning on the projector (→ page 12)*
- *Change the On-Screen menu language (→ page 13)*



Step 3

- *Selecting a source (→ page 14)*



Step 4

- *Adjusting the picture size and position (→ page 15)*
- *Correcting keystone distortion [KEYSTONE] (→ page 20)*



Step 5

- *Adjusting a picture and sound*
 - *Optimizing a computer signal automatically (→ page 22)*
 - *Turning up or down volume (→ page 22)*



Step 6

- *Making a presentation*



Step 7

- *Turning off the projector (→ page 23)*



Step 8

- *When Moving the Projector (→ page 24)*

② Connecting Your Computer/Connecting the Power Cord

1. Connect your computer to the projector.

This section will show you a basic connection to a computer. For information about other connections, see "7. Installation and Connections" on page 72.

Connect the computer cable (VGA) between the projector's COMPUTER IN terminal and the computer's port (mini D-Sub 15 Pin). Turn two thumb screws of both terminals to fix the computer cable (VGA).

2. Connect the supplied power cord to the projector.

First connect the supplied power cord's three-pin plug to the AC IN terminal of the projector, and then connect another plug of the supplied power cord directly in the wall outlet. Do not use any plug converter.

The projector's power indicator will start blinking orange.

* This will apply for both indicators when [NORMAL] is selected for [STANDBY MODE]. See the Power Indicator section. (→ page 88)

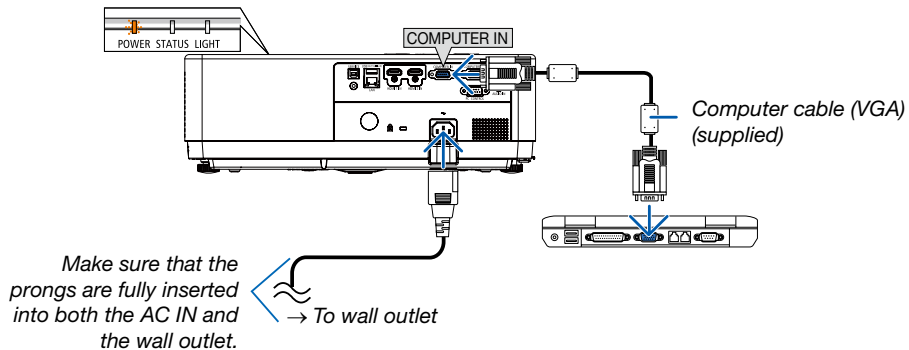

⚠ CAUTION:

Parts of the projector may become temporarily heated if the projector is turned off with the POWER button or if the AC power supply is disconnected during normal projector operation. Be careful to handle the projector.

3 Turning on the Projector

1. Remove the lens cap.

(For PE506UL only)

Press and hold both ends of the lens cap and pull it toward you.

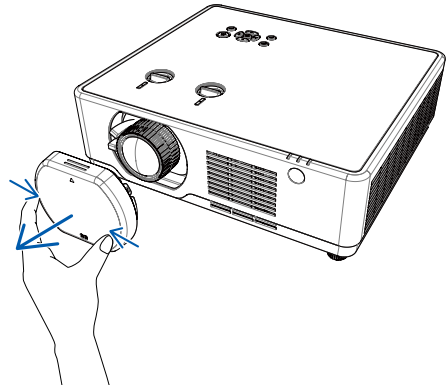

2. Press the  (POWER) button on the projector cabinet or the POWER ON button on the remote control.

The POWER indicator will blink and the projector will become ready to use.

TIP:

- When the message “PIN code” is displayed, it means that the [SECURITY] feature is turned on. (→ page 51)

After you turn on your projector, ensure that the computer or video source is turned on.

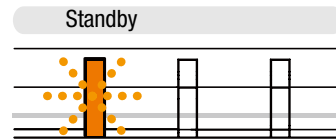
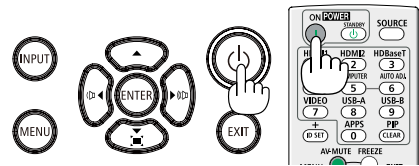

POWER STATUS LIGHT

Blanking orange light



Power On

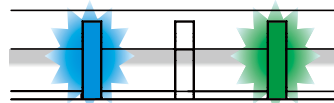

POWER STATUS LIGHT

Steady blue light Steady green light

OR

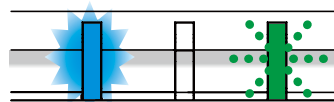

POWER STATUS LIGHT

Steady blue light Blanking green light

(→ page 88)

④ Change the On-Screen menu language

Selecting the On-Screen

1. Press the MENU button on the remote control or on the top control panel to display the On-Screen menu.
2. Press ▲ ▼ button to select the Expand menu, then press the ENTER or ► button to select the Language option.
3. Then press ▲ ▼ button to select the required language.
(→ page 46)

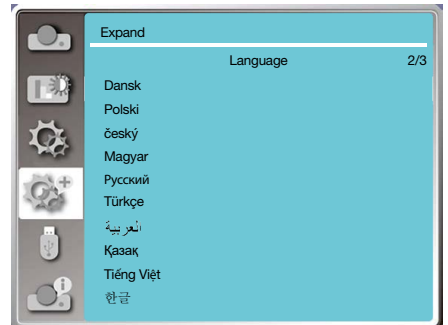
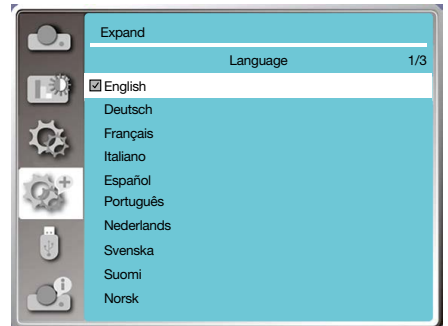
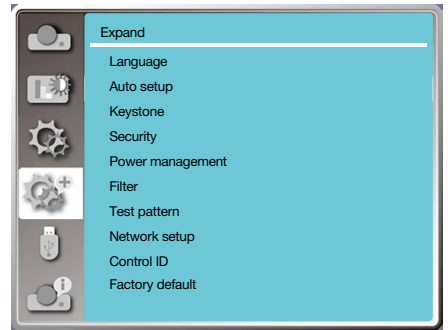

5 Selecting a Source

Selecting the computer source

NOTE: Turn on the computer source equipment connected to the projector.

Detecting the Signal Automatically

Press the INPUT button. The projector will search for the available input source and display it. The input source will change as follows:

Computer → HDMI1 → HDMI2 → USB-A → LAN

- With the INPUT screen displayed, you can press the ▲▼ button to select the input source.

TIP: If no input signal is present, the input will be skipped.

Using the Remote Control

Press any one of the Computer, HDMI1, HDMI2, USB-A, or APPS buttons.

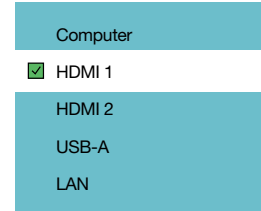
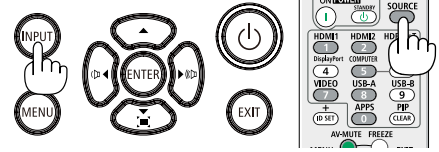

6 Adjusting the Picture Size and Position

Use the adjustable tilt foot, the zoom function or the focus ring to adjust the picture size and position.
In this chapter drawings and cables are omitted for clarity.

Adjusting the throw angle (the height of an image)
[Tilt foot] (→ page 16)

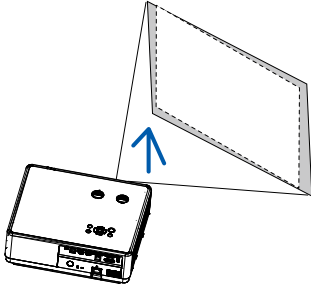

Finely adjusting the size of an image
[Zoom lever] (→ page 17)

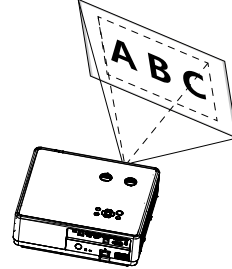

Adjusting the focus
[Focus ring] (→ page 17)

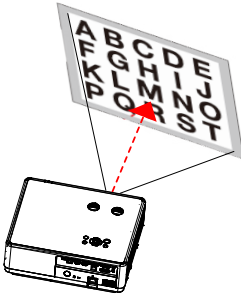

Adjusting the projected image's vertical and horizontal position
[Lens shift] (→ page 18)

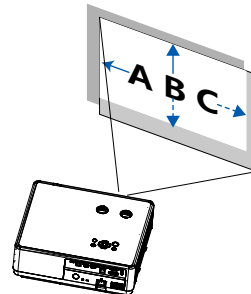

Adjusting the keystone correction [KEystone]* (→ page 20)

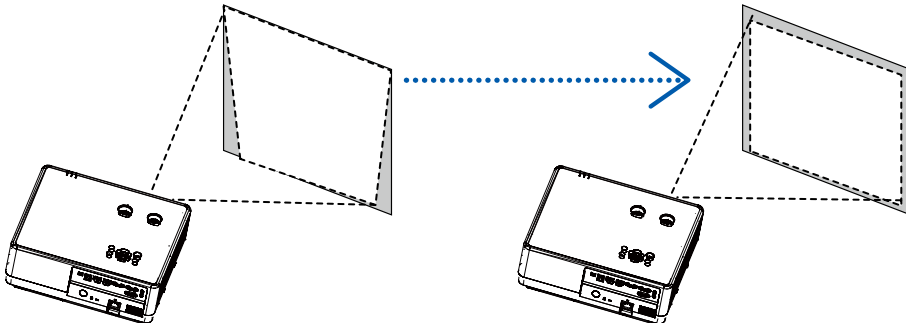

Automatic Keystone Correction function is turned off at the time of shipment.

To perform keystone correction manually, see “6 Correcting Keystone Distortion [KEystone]” on page 20.

2. Projecting an Image (Basic Operation)

Adjust the Tilt Foot

1. Place the projector perpendicular to the screen..

⚠ CAUTION:

Do not try to touch the exhaust vent during tilt foot adjustment as it can become heated while the projector is turned on and after it is turned off.

2. Rotate the left and right adjustable tilt foot to make adjustments to the desired height.

- Rotate the tilt clockwise to raise the projector, and counterclockwise to lower the projector or retract the adjustable foot.
- The tilt foot can be extended up to 0.71 inch/18 mm.
- There is approximately 3.5 degrees (up) of adjustment for the front of the projector.

⚠ CAUTION:

- Do not use the tilt-foot for purposes other than originally intended. Misuses such as using the tilt foot to carry or hang (from the wall or ceiling) the projector can cause damage to the projector.

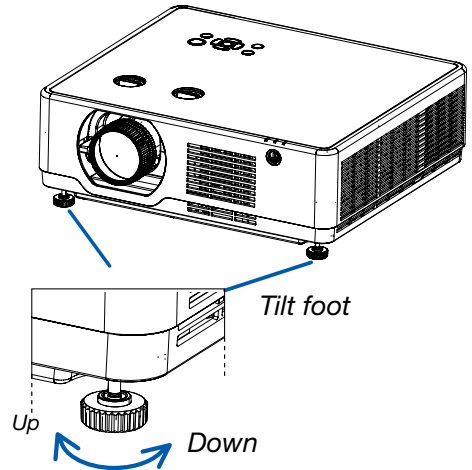

2. Projecting an Image (Basic Operation)

Zoom

Use the ZOOM lever to adjust the image size on the screen.

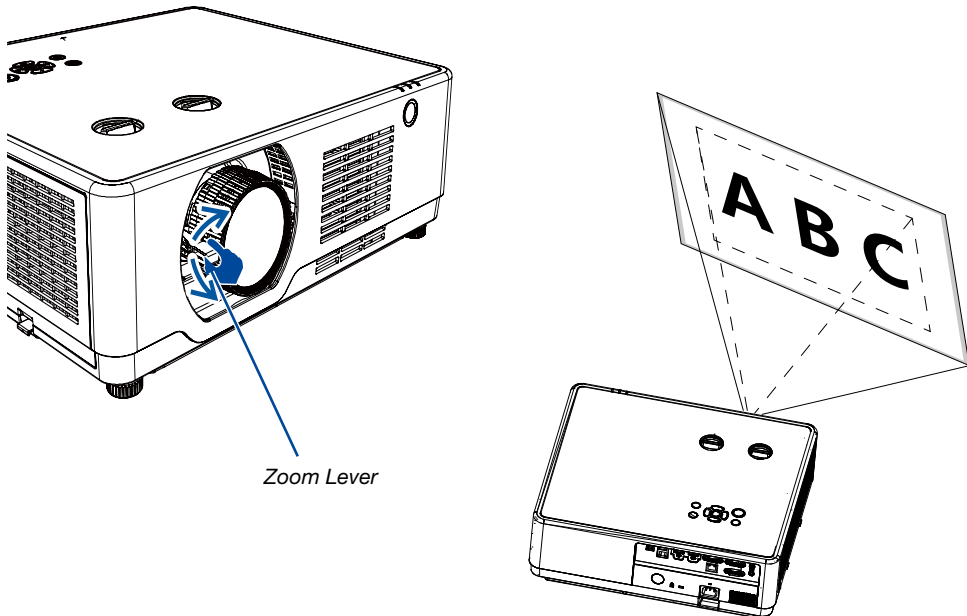

Focus

Use the FOCUS ring to obtain the best focus.

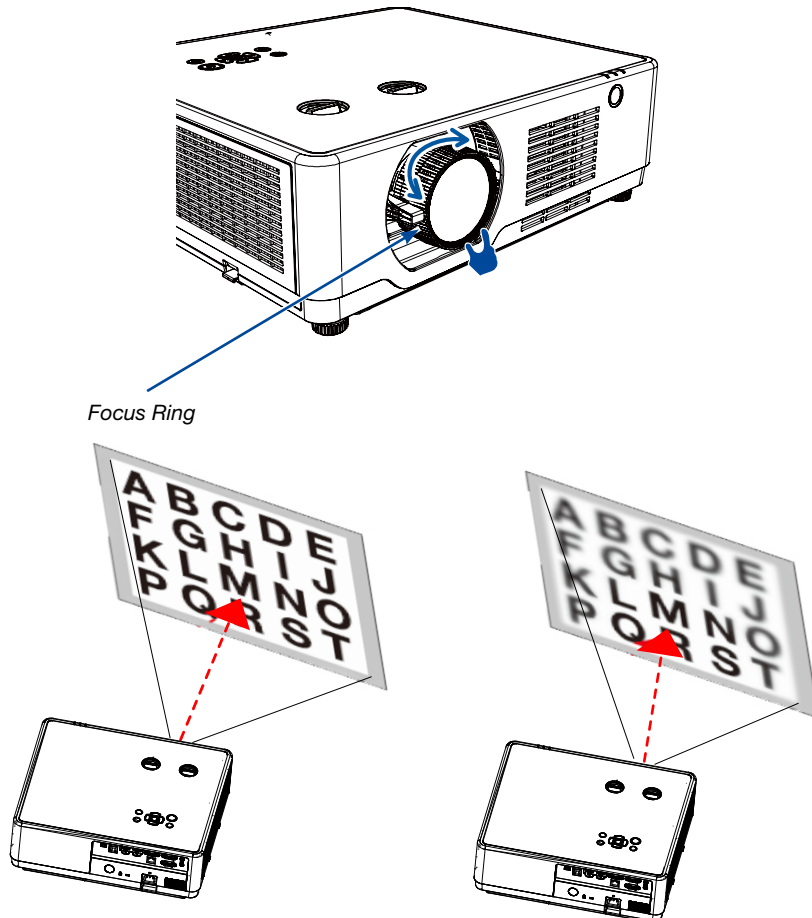

2. Projecting an Image (Basic Operation)

Lens shift

Press the ① and ② dial to make Lens shift adjustment manually.

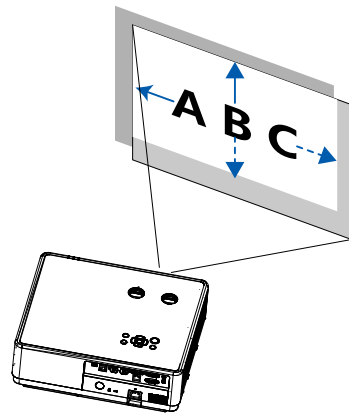

Rotate ① dial, then you can move upward and downward the image with a distance up to +55% (PE506WL) and 60% (PE506UL) between the upper and lower range of the image.

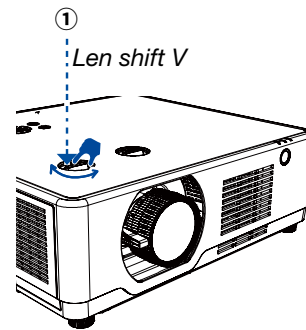

Rotate ② dial, then you can move rightward and leftward the image with a distance up to -26% ~ +26% (PE506WL) and -29% ~ +29% (PE506UL) of the width of the image.

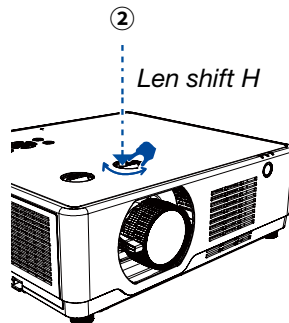

TIP:

- The diagram below shows the lens shift adjustment range ([ORIENTATION]: [DESKTOP FRONT]).
- For the lens shift adjustment range regarding the [CEILING FRONT] projection, see page 70-71.

[PE506UL]

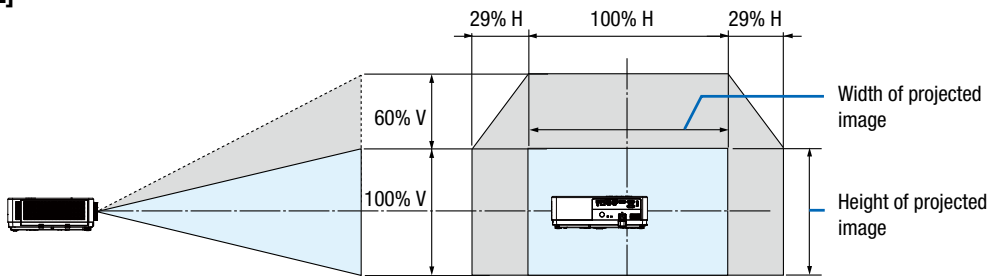

2. Projecting an Image (Basic Operation)

[PE506WL]

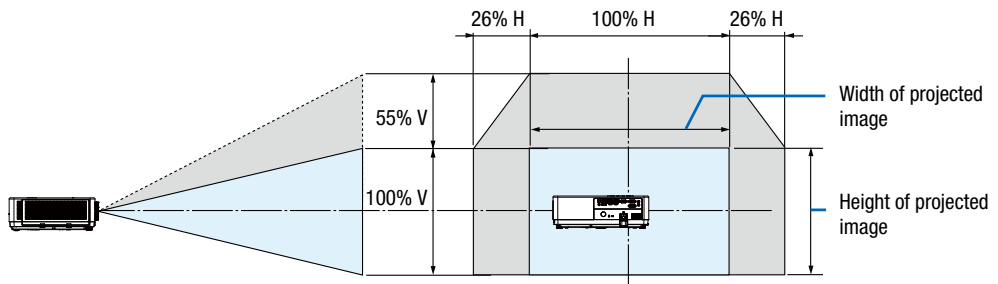

Description of symbols: V indicates vertical (height of the projected image), H indicates horizontal (width of the projected image).

7 Correcting Keystone Distortion [KEYSTONE]

You may adjust keystone distortion of image in your projector with the H/V keystone adjustment. Follow steps below to adjust keystone distortion of projected image manually.

Before performing KEYSTONE correction

Press the KEYSTONE button on your remote control. The keystone adjustment dialog box displays (including H/V keystone, 4-Corner correction, 6-Corner correction, Curved correction, Grid Image Tune, Reset), press ▲▼◀▶ button to adjust keystone distortion.

You may save your settings for keystone adjustment.

- H/V keystone.....Adjust the projected image when the projector is on the horizontal or vertical keystone distortion.
- 4-Corner correction.....Adjust the projected image when the projector is keystone distortion of four corners .
- 6-Corner correction.....Adjust the projected image when the projector is keystone distortion of six corners.
- Curved correction.....Adjust the projected image when the projector linearity is uneven or the projected images bent vertically and horizontally.
- Grid image tune.....Adjust the local points of the projected image.
- Reset.....The correction values will be restored to the factory defaults.

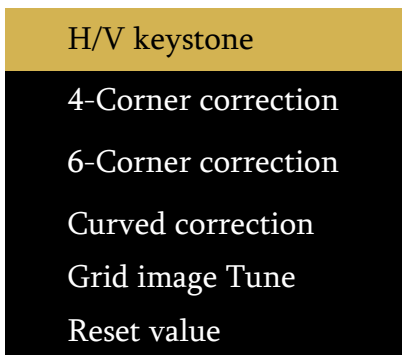

1. Press the ▼ button on the projector cabinet.
The H/V keystone screen will be displayed on the screen.
 - Press the KEYSTONE button when using the remote control.
2. Press the ▼ button to select H/V keystone, then press the ENTER button to select the H keystone. And press the ◀▶ button to make adjustment so that the left and right sides of the projected image are parallel.
 - Adjust the horizontal keystone distortion.

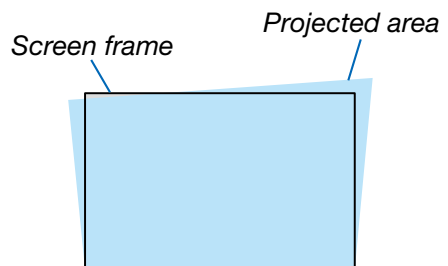

2. Projecting an Image (Basic Operation)

3. Align the left (or right) side of the screen with the left (or right) side of the projected image.

- Use the shorter side of the projected image as the base.
- In the right example, use the left side as the base.

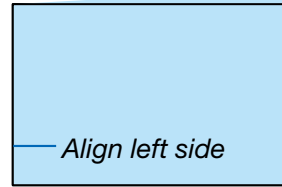

4. Press the ▼ button to select V KEYSTONE and then use the ▲▼ button so that the top and bottom sides of the projected image are parallel.

- Adjust the vertical keystone distortion.

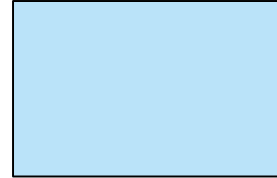

5. Repeat steps 2 and 4 to correct keystone distortion.

6. After completing Keystone correction, press the EXIT button for some time to turn off the menu.

NOTE:

- The arrow mark looks white when there is no keystone adjustment in existence.
 - The arrow mark indicating the adjustment direction turns red.
 - The arrow mark disappears when the maximum H/V keystone adjustment limit reaches.
 - The keystone prompt box will disappear if you press the keystone button again when it is displaying. Press the ENTER button again to switch the six correction items.
 - The adjustable range is subject to source of signal input.
 - For further details about keystone function, please turn to page [48-51](#).
 - When using the VIEWER, you cannot use the ▼ button on the panel to directly call up the keystone correction menu.
-

To return the keystone adjustments to default:

1. The Keystone screen will be displayed on the screen.
 2. Press ▼ button to select Reset.
 3. Press the ► or the ENTER button.
 - The adjustments will be reset.
-

NOTE:

All adjusted values set in the [KEYSTONE] adjustment are reset to initial values

8 Optimizing Computer Signal Automatically

Adjusting the Image Using Auto Adjust

Optimizing a computer image automatically. (Auto PC adj.)

Press the AUTO ADJ. button to optimize a computer image automatically. This adjustment may be necessary when you connect your computer for the first time.

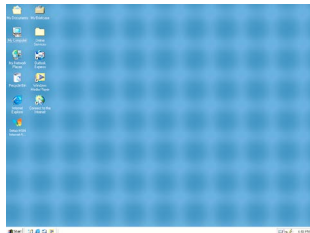
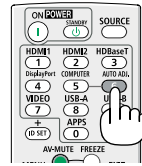

[Poor picture]

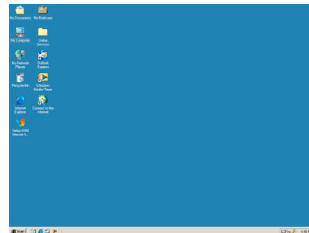

[Adjusted picture]

NOTE:

- Some signals may take some time to display or may not be displayed correctly.
- If the Auto Adjust operation cannot optimize the computer signal, try to adjust [Fine sync], [H position], [V position], and [H. size] manually. (→ page 34, 35)

9 Turning Up or Down Volume

Sound level from the speaker or audio output can be adjusted.

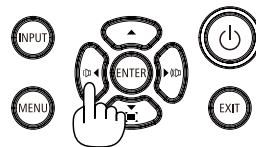
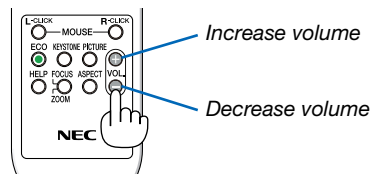

TIP: When no menus appear, the ◀ and ▶ buttons on the projector cabinet work as a volume control.

When the above volume adjustment menu appears, press ▲ and ▼ buttons to control the mute on and off.

NOTE:

- Volume control is available with the ◀ or ▶ button but invalid through the remote control when an image is magnified by using the D-ZOOM (+) button or when the menu is displayed.
- Volume control is not available with the ◀ or ▶ button when VIEWER is used.

10 Turning off the Projector

To turn off the projector:

1. First, press the  (POWER) button on the projector cabinet or the STANDBY button on the remote control.

The confirmation message will be displayed.

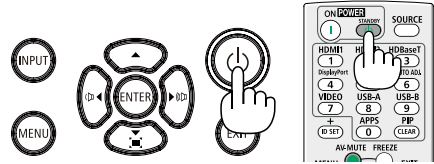
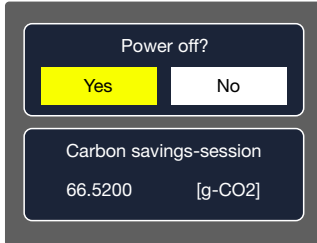

2. Secondly, press the ENTER button or press the  (POWER) or the STANDBY button again.

The light source will turn off and the projector will go into standby mode. When in standby mode, the POWER indicator will be blinking orange and the STATUS and LIGHT indicators will turn off when [Normal] is selected for [STANDBY MODE].

Power On

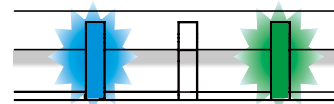

POWER STATUS LIGHT

Steady blue light Steady green light

OR

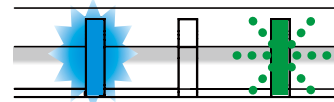

POWER STATUS LIGHT

Steady blue light Blanking green light



Standby

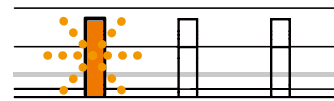

POWER STATUS LIGHT

Blanking orange light

CAUTION:

Parts of the projector may become temporarily heated if the projector is turned off with the POWER button or if the AC power supply is disconnected during normal projector operation.
Use caution when picking up the projector.

NOTE:

- While the power indicator is blinking blue in short cycles, the power cannot be turned off.
- You cannot turn off the power for 60 seconds immediately after turning it on and displaying an image.
- Do not disconnect the AC power supply to the projector within 10 seconds after making adjustment or setting changes and closing the menu. Doing so can cause loss of adjustments and settings.

① When Moving the Projector

Preparation: Make sure that the projector is turned off.

1. *Put on the lens cap(For PE506UL only).*

2. *Unplug the power cord.*

3. *Disconnect any other cables.*

- *Remove the USB memory or the USB Wireless LAN Unit if it is inserted into the projector.
(→ page [27,77](#))*

3. Convenient Features

1 Turning off the Image and Sound

Press the AV-MUTE button to turn off the image and sound for a short period of time. Press again to restore the image and sound.

NOTE:

- Even though the image is turned off, the menu still remains on the screen.
- Sound from the AUDIO OUT jack (Stereo mini) can be turned off.

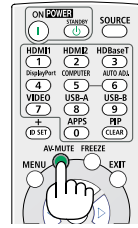

2 Freezing a Picture

Press the FREEZE button to freeze a picture. Press again to resume motion.

NOTE: The image is frozen but the original video is still playing back.

- This feature can not be used when LAN, and USB-A is selected as the input terminal.

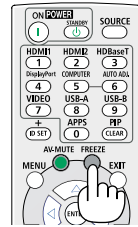

3 Magnifying a Picture

You can enlarge the picture up to four times.

NOTE:

- The maximum magnification may be less than four times depending on the signal.
- This feature can not be used when LAN, and USB-A is selected as the input terminal.

To do so:

1. Press the D-ZOOM (+) button to magnify the picture.

To move the magnified image, use the ▲, ▼, ◀ or ▶ button.

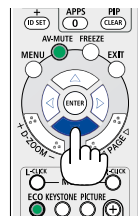
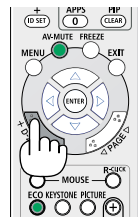
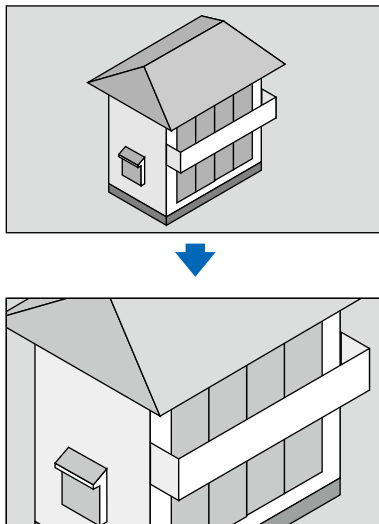

3. Convenient Features

2. Press the ▲▼◀▶ button.

The area of the magnified image will be moved.

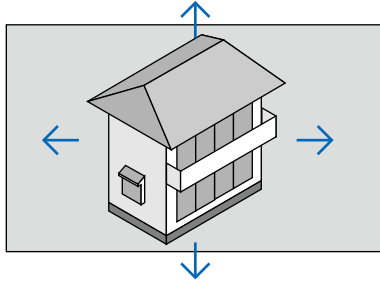

3. Press the D-ZOOM (-) button to magnify the picture.

Each time the D-ZOOM (-) button is pressed, the image is reduced.

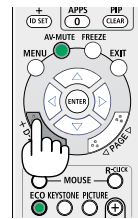

NOTE:

- The image will be magnified or demagnified at the center of the screen.
- Press the ASPECT button on the remote control or select the Aspect function on the Display menu can cancel the current magnification.

4. Using the VIEWER

USB-A function

When the USB memory insert into the projector, the USB-A function can project pictures which is stored in the USB memory.

The projected content of USB-A function

USB-A function supports the following picture files.

	Extension name	Format	Description
Maps	jpg/jpeg	Baseline encoder 24 Progressive RGB24 bit	Max resolution: 10000x10000 Max resolution: Panel Resolution
	bmp	1.4.8 bit palette-based RGB24,32 bit	Max resolution: 1280X800
	png	24, 48-bit True Color	
	gif	1,4,8-bit palette-based	
	tiff		

Display USB-A screen

When the USB memory insert into the projector, the USB-A function can project pictures which is stored in the USB memory.

- 1) Press SOURCE button on the remote control or INPUT on the top control, then select the input source of [USB-A].
- 2) Insert the USB memory into the USB Port (Type A) directly.
 - Press the ENTER button to display standby screen instantly, while the USB memory icon display in the lower left corner of the screen.
 - When the USB memory is independent of the partition, it will display more than one USB icon.
- 3) Press ▲▼◀▶ button to switch required items.
 - The root directory of the USB memory is displayed in a thumbnail.

Play image

Only one image show on the screen when you play it.

- 1) Press ▲▼◀▶ button to select a image.
- 2) Press the ENTER or ▶ button.
 - Full screen display
- 3) Press the ENTER button.
 - Press the ENTER button to return the thumbnail.

Play slide

Turn on set slide in the USB-A menu to play the file, other files in the same folder can play automatically.

- 1) Press ◀▶ button to select a file.
- 2) Press the ENTER or ▶ button.
 - Full screen display.
- 3) Press the ENTER button.
 - Press the ENTER button to return the thumbnail.

The termination of USB-A

The slide transition effect in the USB-A menu is set to "Slide right" or "Slide down", all images in the same folder can play automatically.

- 1) Press ▲▼◀▶ button to select , displayed in the upper left corner of the screen.
- 2) Press the ENTER button.
- 3) Unplug the USB memory directly.

NOTE:

- Only USB memory up to FAT32 (32GB) can be read.
- When you insert a USB memory, please make sure insertion direction to avoid damaging the port.
- Please note the following points when inserting and removing USB memory:
 - a. The indicator flashes, when the USB memory insert into the projector or the projector is reading data. DO NOT remove the USB memory when the light is flashing.
 - b. Do not insert and remove USB memory frequently. Then remove it after the installation of at least 5 seconds. After removing at least 5 seconds and then reinsert it.
 - c. Due to the file format, some pictures cannot display thumbnails.

Precautions on processing and storage of USB memory

- If smoke or produce abnormal smell, close the external device and contact the dealer.
 - Do not put foreign matter or metal items in the USB port. Static electricity may cause data loss or data damage.
-

5. Using On-Screen Menu

① Menu item overview

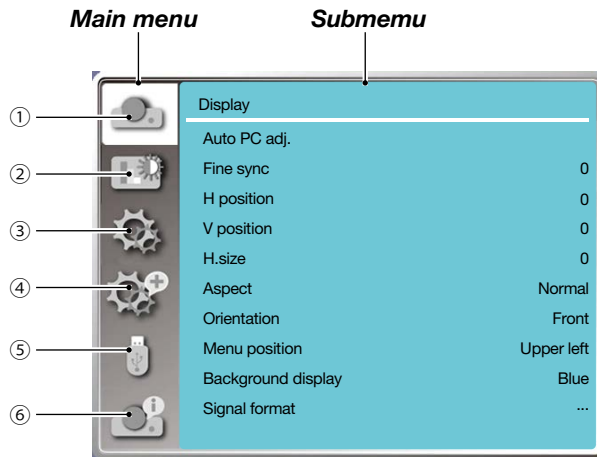

1. Display menu

- **Select Auto PC adj., Fine sync, H position, V position, H. size to adjust the parameters to match the VGA format.**
- **Aspect: Normal/Wide/Full/4:3.**
- **Orientation: Choose Front, Auto ceiling/Rear, Auto ceiling/Front, Ceiling / Rear, Ceiling / Front and Rear.**
- **Menu position: Set screen menu display position on the screen.**
- **Background display: Set the background color of the projection screen.**
- **Signal format: Select the compatible system signal format with input source.**

2. Color adjust menu

Available options in the Image mode menu are Dynamic, Standard, Cinema, Blackboard (Green), Color board, or User image.

The available color adjust options: Contrast, Brightness, Color temp. , Red, Green, Blue and Sharpness.

3. Setting menu

Configuration of the basic function operation on the projector: On start, Standby mode, High altitude, Cooling fast, Key lock, Baud rate, Contrast optimization, Laser control, Sound and HDMI setup.

4. Expand menu

Available adjust options are Language, Auto setup, Keystone, Security, Power management, Filter, Test pattern, Network setup, Control ID and Factory default.

5. USB-A menu

Select parameter of Set slide, Slide transition effect, Sort order, Rotate, Best fit, Repeat, Apply.

6. Information menu

Display information about the projector.

② List of Menu Items

Some menu items are not available depending on the input source.

Main menu	Sub-menu	Setting	Remarks
Display	Auto PC adj.		
	Fine sync	0-31	
	H position	-5 - +5	
	V position	-5 - +5	
	H. Size	-15 - +15	The range of H. size differs from signals.
	Aspect	Normal*/Wide/Full/4:3	
	Orientation	Front * Rear Ceiling / Front Ceiling / Rear Auto ceiling / Front Auto ceiling / Rear	
	Menu position	Upper left* Upper right Center Lower left Lower right	
	Background display	Black,Blue*,Logo	
Signal format	---	The selected Signal format displays in the Signal format menu	
Color adjust	Image mode	Standard* Cinema Blackboard(Green) Color board User image Dynamic	
	Contrast	0-63 (32 *)	
	Brightness	0-63 (32 *)	
	Color temp	High/Mid*/Low/User	
	Red	0-63 (32 *)	
	Green	0-63 (32 *)	
	Blue	0-63 (32 *)	
	Sharpness	0-15 (8 *)	
Setting	On start	On/Off*	
	Standby mode	Normal*/Sleep/Network standby	
	High altitude	On/Off*	
	Cooling fast	60 Sec/0 Sec*/30 Sec	
	Key lock	On/Off*	
	Contrast optimization	On/Off*	

* The asterisk (*) indicates that the default setting varies depending on the signal.

5. Using On-Screen Menu

Main menu	Sub-menu	Setting		Remarks	
Setting	Baud rate	4800/9600/19200*/38400			
	Laser control	ECO mode	Normal*/ECO1/ ECO2/Full Normal		
		Laser adjust.	50%-100% (100%*)	Only for Normal mode	
	Sound	Volume	0-25(12 *)		
		Mute	On/Off*		
	HDMI setup	Image	Auto*/64-940/ 0-1023		
		Sound	HDMI*/ Computer		
	Expand	Language	Projector provides multiple language support (English*)		
		Auto setup	Input search	On*/Off	
			Auto PC adj.	On*/Off	
Auto keystone			On/Off*		
Keystone		Keystone	Store* / Reset		
		H/V keystone			
		4-Corner correction			
		6-Corner correction			
		Curved correction			
		Grid image tune			
		Reset			
Security		PIN code lock	On/Off*		
		PIN code change			
Power management		Ready* Shut down Off Timer Ready countdown			
Filter		Filter counter Timer Filter counter reset			
Test pattern		Off*, Gray scale (1-4) , Color bar, Red, Green, Blue, Cross hatch , White, Black, Raster gray			

* The asterisk (*) indicates that the default setting varies depending on the signal.

5. Using On-Screen Menu

Main menu	Sub-menu	Setting		Remarks
Expand	Network setup	Network setting	Wired LAN	DHCP(On/Off*) IP address Subnet Gateway DNS
			Wireless LAN	Setting(On/Off*)
		Network information		
		MAC address		
		IP address		
	Control ID	Control ID	On/Off*	
		Control ID number	1-254(1*)	
	Factory default			
USB-A	Set slide			
	Slide transition effect		Slide down Slide right*	
	Sort order		Extend order Name order* Time order Size order	
	Rotate		No rotate* 270 degree 180 degree 90 degree	
	Best fit		On/Off*	
	Repeat		On/Off*	
	Apply			
Info.	Input			
	H- sync freq.			
	V- sync freq.			
	Light counter			
	Model name			
	S/N			
	Firmware version			
	SUBCPU			

* The asterisk (*) indicates that the default setting varies depending on the signal.

③ Menu Descriptions & Functions [INPUT]

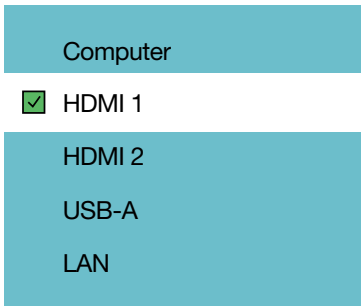

Computer

Selects the computer connected to your Computer input terminal signal.

NOTE: When the component input signal is connected to the COMPUTER IN terminal, select [Computer].

HDMI1 and HDMI2

Selects the HDMI compatible equipment connected to your HDMI1 or 2 IN terminal.

USB-A

This feature enables you to make presentations using a USB memory that contains pictures.
(→ page 27 “4. Using the VIEWER”)

LAN

Selects a signal from the LAN port (RJ-45).

④ Menu Descriptions & Functions [Display menu]

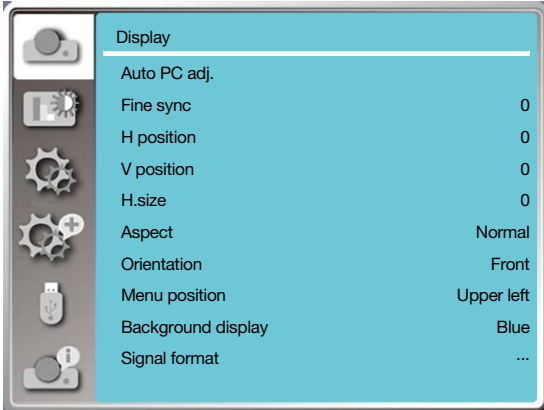

[Auto PC adj.]

Select Auto PC Adj. function can adjust Fine sync, H position, V position, H. size to be compatible with the computer automatically.

Press the MENU button on the remote control or on the top control panel to display the On-Screen menu.

Press ▲ ▼ button to select the Display menu, then press the ENTER or ► button.

- 1) Press ▲ ▼ button to select [Auto PC adj.] menu.
- 2) press the ENTER button.

NOTE:

- The projector will perform Auto PC adj. function automatically, when its signal is input for the first time.
 - Auto PC adj. function may fail to work if computer models is not compatible with the input signal.
 - Auto PC adj. function may fail to work if you select the following system signal format: 480i, 576i, 480p, 576p, 720p, 1080i, 1080p, or signals from the HDMI terminal.
-

[Fine sync]

(Only for PC signal input)

Adjust image to the best state When the image jitters, or the image outline dims.

- 1) Press ▲ ▼ button to select [Fine sync] menu.
 - 2) Press the ENTER button.
 - 3) Press ▲ ▼ button to adjust Fine sync.
- Adjustment range is from 0 to +31. Please adjust to the least interference state.

[H position]

(Only for PC signal input)

On the premise that the relative position of both projector and the screen is set up right, you can move the image horizontal position, if the position of the projected image on the screen is deviated.

- 1) Press ▲ ▼ button to select [H position] menu.
- 2) Press the ENTER button.
- 3) Press ▲ ▼ button to adjust image H position.

Adjustment range is from -5 to +5.

[V position]

(Only for PC signal input)

On the premise that the relative position of both projector and the screen is set up right, you can move the image vertical position, if the position of the projected image on the screen is deviated.

- 1) Press ▲▼ button to select [V position] menu.
- 2) Press the ENTER button.
- 3) Press ▲▼ button to adjust image V position.

Adjustment range is from -5 to +5.

[H. size]

(Only for PC signal input)

You can adjust and reduce the interference caused by patterns of the projected vertical stripes. The following projected patterns may cause a circular pattern (Noise). Adjust the amount of interference to the minimum. Users can point the clock to adjust images.

- 1) Press ▲▼ button to select [H. size] menu.
- 2) press the ENTER button.
- 3) Press ▲▼ button to adjust H. size level .

Adjustment range is from -15 to +15.

[Aspect]

Adjust the image to fit the screen size, while keeping aspect of input signal's unchanged.

Press the MENU button on the remote control or on the top control panel to display the On-Screen menu. Press ▲▼ button to select the Display menu, then Press the ENTER or ► button.

- 1) Press ▲▼ button to select [Aspect] menu.
- 2) Press the ENTER button.
- 3) Press ▲▼ button to select the required item.

Normal..... Use the maximum size to project while keeping the aspect of input signal's unchanged.

Wide..... Project images at the aspect of 16: 9.

Full..... Project images to the maximum.

4:3..... Project images at the aspect of 4:3.

16:10..... Project images at the aspect of 16:10.

NOTE:

- This projector can be selected from Normal / Wide / Full / 4:3.
- 16:10 will be grayed out on this projector.

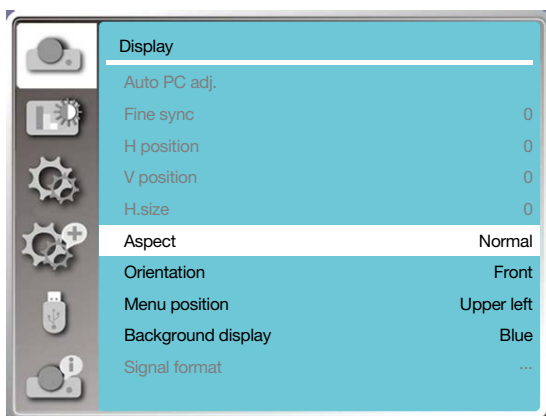

[Orientation]

Select this function to set the project way.

Please change the projection way, if the On-Screen menu displays inversely or reversedly.

Press the MENU button on the remote control or on the top control panel to display the On-Screen menu. Press ▲ ▼ button to select the Display menu, then press the ENTER or ► button.

1) Press ▲ ▼ button to select [Orientation] menu.

2) Press the ENTER button.

3) Press ▲ ▼ button to switch.

Front: When the projector is installed on the table and projected in front of the screen.

Rear: When the projector is installed on the table and projected in rear of the screen (using translucent screen)

Ceiling / Front: When use the ceiling mount (Commercially available) to lift the projector in front of the screen.

Ceiling / Rear: When use the ceiling mount (Commercially available) to lift the projector in rear of the screen (using translucent screen).

Auto ceiling / Front: When the projector is projected in front of the screen. The built-in angle sensor detects the angle of the projector automatically and then switches to [Front] or [Ceiling/Rear]. When front projection, please set it to this option. (→ page 9)

Auto ceiling / Rear: When the projector is projected in front of the screen. The built-in angle sensor detects the angle of the projector automatically and then switches to [Rear] or [Ceiling/Rear]. When rear projection, please set it to this option.(→ page 9)

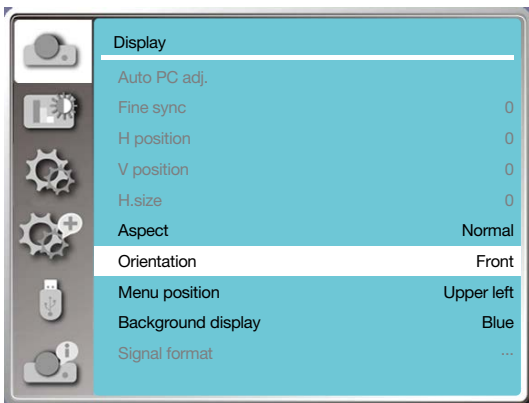

⚠ WARNING

- Should special works be required, for example to suspend the projector from the ceiling, consult your dealer.
- Never try to install the projector yourself in such cases. The projector could drop and cause injury.

[Menu position]

Select this function to set the On-Screen Menu position.

Press the MENU button on the remote control or on the top control panel to display the On-Screen menu. Press ▲ ▼ button to select the display menu, then press the ENTER or ► button.

1) Press ▲ ▼ button to select [Menu position] menu.

2) Press the ENTER button.

3) Press ▲ ▼ button to change menu position.

Upper leftThe menu display on the upper left corner of the screen.

Upper rightThe menu display on the upper right corner of the screen.

Center.....The menu display in the center of the screen.

Lower leftThe menu display on the lower left corner of the screen.

Lower rightThe menu display on the lower right corner of the screen.

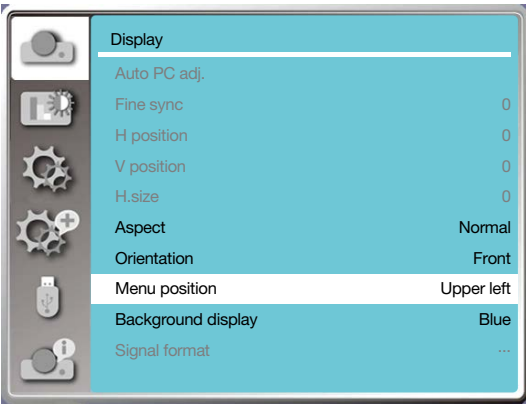

[Background display]

Select this function can adjust background color when there is no input signal.

Press the MENU button on the remote control or on the top control panel to display the On-Screen menu. Press ▲ ▼ button to select the Display menu, then press the ENTER or ► button.

- 1) Press ▲ ▼ button to select [Background display] menu.
- 2) Press the ENTER button.
- 3) Press ▲ ▼ button to select required item .

Blue..... The entire projection area display blue.

Black.....The entire projection area display black.

Logo.....The entire projection area display NEC PROJECTOR background.

NOTE:

- This function will be invalid once you select input signal as USB-A and LAN.
-

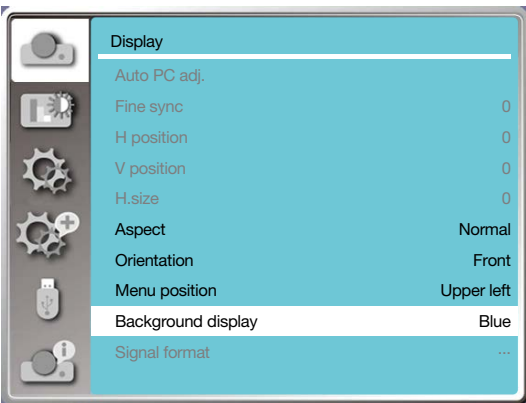

[Signal format]

If a PC is selected as the input signal source, your projector will detect and adapt to its signal format automatically. Correct image can be displayed without any setup operation.

Your projector will display one of the following:

Auto: The Auto PC Adjusting function will make necessary adjustment to your projector to project valid images. If images are displayed incorrectly, adjust it manually.

---- : No PC signals detected. Check the connection between PC and your projector.

NOTE:

- Your projector may save data generated by the Auto PC adj. function.
-

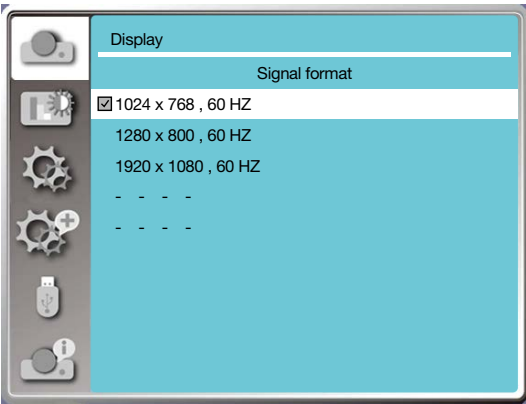

- The selected Signal format displays in the Signal format menu.

Select the computer Signal format manually.

1. Press the MENU button on remote control and the On-Screen displays. Press ◀▶ button to point to the Input icon, press ▲▼ button or the ENTER button and the Input menu displays.
2. Press ▲▼ button to select Signal format, then press ENTER button.

NOTE:

- The computer Signal format menu will be disabled once HDMI 1, HDMI 2, USB-A, LAN has been selected.
-

5 Menu Descriptions & Functions [Color adjust]

Select color adjustment to set the image mode and adjust the quality of the projected image.

Menu operation

Press the MENU button on the remote control or on the top control panel to display the On-Screen menu. Press ▲▼ button to select the Color adjust menu, then press the ENTER or ▶ button.

- 1) Press ▲▼ button to select required item.
- 2) Press the ENTER button.
- 3) Press ▲▼ button to select adjust set point.

[Image mode]

Direct operation

Press the PICTURE select button on remote control to select required image mode.

Menu operation

Press the MENU button on the remote control or on the top control panel to display the On-Screen menu. Press ▲▼ button to select the color adjust menu, then press the ENTER or ▶ button.

- 1) Press ▲▼ button to select [Image mode] menu.
- 2) Press the ENTER button.
- 3) Press ▲▼ button to select required item.

Dynamic

An image mode suitable for viewing in bright room.

Standard

The default mode of your projector, can come to natural color.

Cinema

Enriched gray scale for viewing movies.

Blackboard (Green)

An image mode designed for displaying on a blackboard (Green). It boosts quality of image projected on blackboard

(Green). This is designed for a board in green rather than black as indicated by its name.

Color board

A image mode suitable for image projecting on surface of wall in red, blue, yellow or green. Press the ENTER button to enter Color board menu, then press ▲ ▼ button to select Red, Blue, Yellow or Green, press the ENTER button.

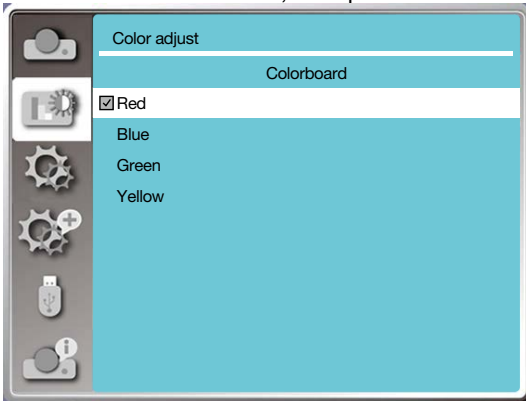

User image

Users can customize the color adjustment.

[Contrast]

Press ▼ button to decrease contrast, range from 0 - +63.

Press ▲ button to increase contrast, range from 0 - +63.

[Brightness]

Press ▼ button to decrease brightness, range from 0 - +63.

Press ▲ button to increase brightness, range from 0 - +63.

[Color temp.]

Press ▲ ▼ button to select required color temperature (Low, Mid., High and User)

High temp: Become blue gradually.

Mid temp: Suitable natural color.

Low temp: Become red gradually.

User: You can adjust the Red, Green, Blue and Yellow values by yourself.

[Red]

Press ▼ button to decrease red tint and ▲ button to increase it.

[Green]

Press ▼ button to decrease green tint and ▲ button to increase it.

[Blue]

Press ▼ button to decrease blue tint and ▲ button to increase.

[Sharpness]

Press ▼ button to soften image and ▲ button to sharpen, range from 0 - +15.

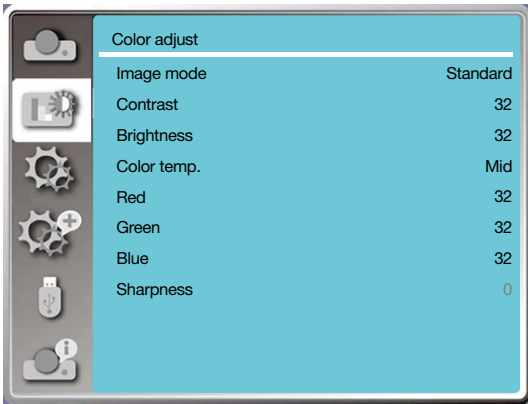

6 Menu Descriptions & Functions [Setting]

The projector has setting function, you can select other functions as described below.

Menu operation

Press the MENU button on the remote control or on the top control panel to display the On-Screen menu. Press ▲ ▼ button to select the setting menu, then press the ENTER or ► button.

- 1) Press ▲ ▼ button to select required item.
- 2) Press the ENTER button.
- 3) Press ▲ ▼ button to set options.

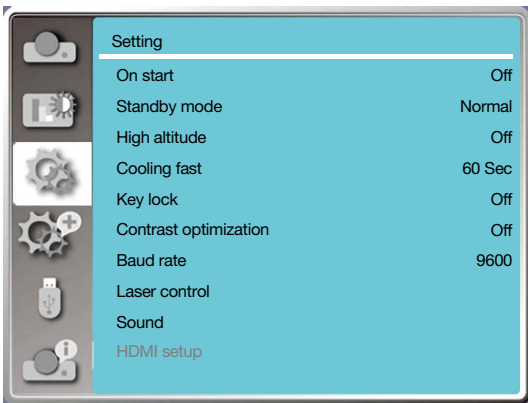

[On start]

Set the option to "On" if selecting this function, the projector will automatically turn on when the power cord is connected to the power outlet.

- 1) Press ▲ ▼ button to select [On start] menu.
- 2) Press the ENTER button.
- 3) Press ▲ ▼ button to select required item.

Off..... Get into standby mode.

On.....Start up immediately.

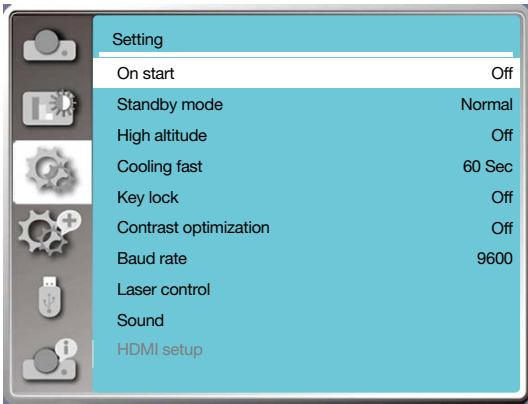

Note:

- After the power is turned off, please wait about 20s after unplugging the AC, and then you can turn on the power. If the power is turned on immediately, it may not work properly.

[Standby mode]

Select this function to switch different standby mode.

- 1) Press ▲ ▼ button to select [Standby mode] menu.
- 2) Press the ENTER button.
- 3) Press ▲ ▼ button to adjust levels.

Normal.....Although the power consumption on this mode is lower than on the [Network standby] or [Sleep] mode, when this mode is selected, only the POWER button on the top control panel or the remote control will work..

Network standby.....Although the power consumption on this mode is higher than on the [Normal] mode, this mode allows you to turn on the projector from standby condition by using the Wake on LAN feature (hereafter referred to as WoL) via LAN.

Consult your network administrator for more information about WoL.

SleepAlthough the power consumption on this mode is higher than on the [Network standby] mode, this mode spends less time to turn on the projector from standby condition via LAN compared to the [Network standby] mode.

To control the projector by using our application software NaViSet Administrator 2, select the [Sleep] mode.

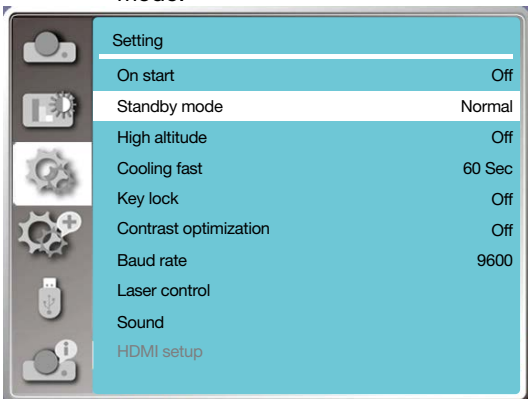

[High altitude]

You can change the setting about speed of cooling fan according to the altitude your projector is operating at.

- 1) Press ▲ ▼ button to select [High altitude] menu.

2) Press the ENTER button.

3) Press ▲▼ button to select required menu.

Off: Normal speed. set the option off when operating the operator, if the altitude is not too high.

On: Faster than when in off mode .set the option on when operating the operator in high land.

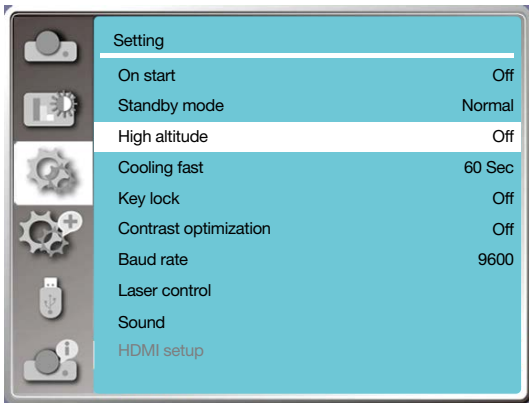

Note:

- The air pressure sensor will sense the altitude automatically. When the altitude is at an altitude of approximately 1700 m/5500 f or higher, projector will turn on the High altitude function automatically, thus the On-screen menu of High altitude will change to "On".
- If the air pressure sensor is damaged, the projector OSD menu will turn red for reminding that the automatic transfer to high altitude function is invalid. User could set High altitude to "On" manually .

[Cooling fast]

Select the cooling time after projector is turned off.

1) Press ▲▼ button to select [Cooling fast] menu.

2) Press the ENTER button.

3) Press ▲▼ button to switch required menu.

60 Sec.....Cooling down in 60 seconds after the projector is turned off.

30 Sec.....Cooling down in 30 seconds after the projector is turned off. And the cooling fan will runs faster then in the normal cooling way with shorter time but it will sounds louder.

0 Sec.....Cooling down instantly after the projector is turned off.

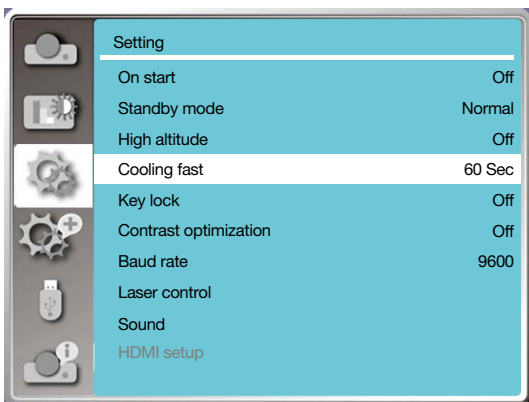

Note:

- Cooling fast function depends on whether user needs to move the projector immediately. If the user needs to unplug the power to move the projector immediately, you can choose "0 Sec", or we can select the "60 Sec" option.

[Key lock]

Select this function to lock and unlock the control panel keypads.

- 1) Press ▲▼ button to select [Key lock] menu.
- 2) Press the ENTER button.
- 3) Press ▲▼ button to switch required menu.

Off.....The control panel keypads are effective.

On.....The control panel keypads is invalid.

NOTE:

- When you lock the top of the control panel keypads, but the remote control is lost or something wrong with it, please contact your dealer or service center.

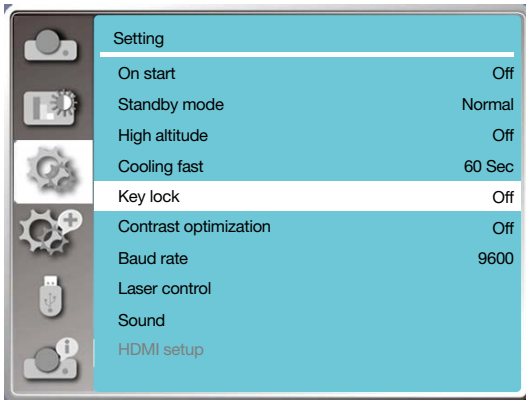

[Contrast optimization]

Select this function to optimize and compensate signal automatically on the basis of the image, to get the best contrast image.

- 1) Press ▲▼ button to select [Contrast optimization] menu.
- 2) Press the ENTER button.
- 3) Press ▲▼ button to adjust.

Off.....No optimization.

On.....Optimize contrast.

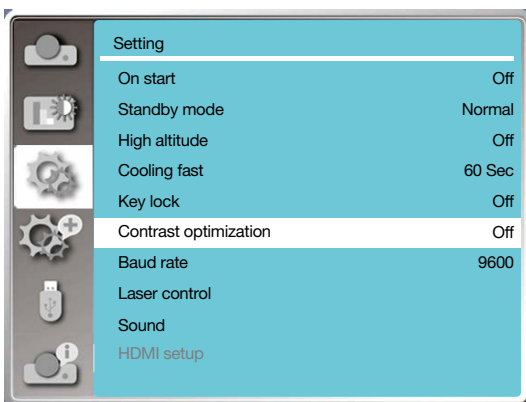

[Baud rate]

Select this function to adjust the projector transmission rate.

- 1) Press ▲▼ button to select [Baud rate] menu.
- 2) Press the ENTER button.
- 3) Press ▲▼ button to select rate: 4800/9600/19200/38400.

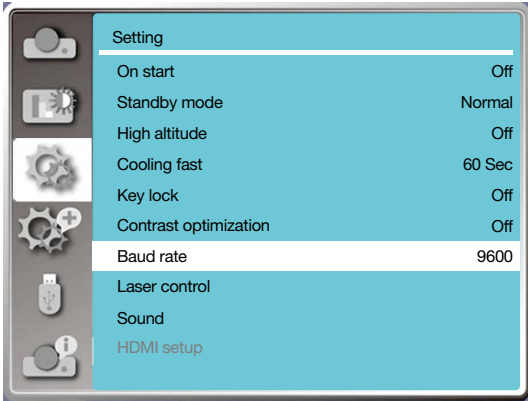

[Laser control]

Change light source brightness according to the environment and aim your projector is operating.

- 1) Press ▲▼ button to select [Laser control] menu.
- 2) Press the ENTER button.
- 3) Press ▲▼ button to select [ECO mode] or [Laser adjust].
- 4) Press the ENTER button.

ECO mode

Normal	Normal brightness, the screen becomes brighter. Alternatively, you can adjust from 50%~100%. Default is 100%.
ECO.1/ECO.2	Lower the brightness and reduce energy consumption.
Full normal	The brightness is the same as normal mode, but it is not adjustable

Laser adjust

This function is valid only in Normal mode, and the adjustable range is 50%-100%. And the menu will turn gray on ECO.1, ECO2 and Full normal mode.

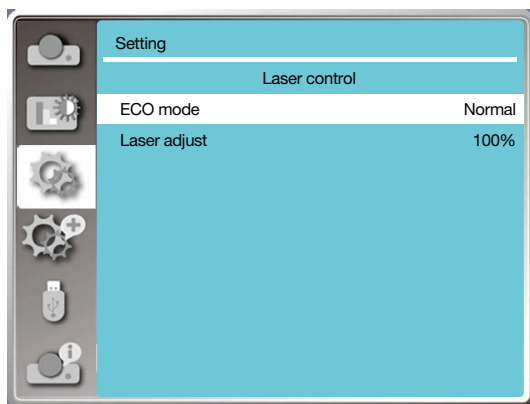
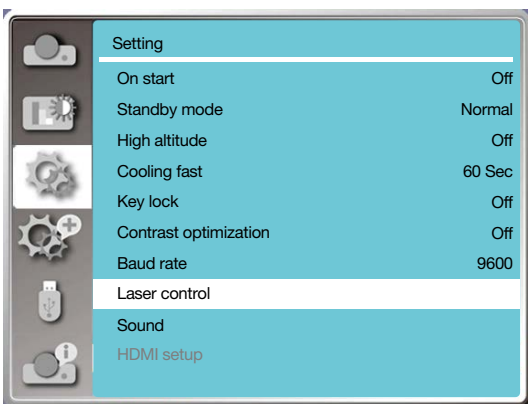

NOTE:

- Laser adjust option can be chosen only in Normal mode.

[Sound]

Select this function to adjust the sound.

- 1) Press ▲▼ button to select [Sound] menu.
- 2) Press the ENTER button.
- 3) Press ▲▼ button to switch required menu.

Volume.....Press ◀ button to turn down the volume and ▶ button to turn up the volume, range from 0 - +25

Mute.....Select "Off" to output audio, and select "On" to disable audio.

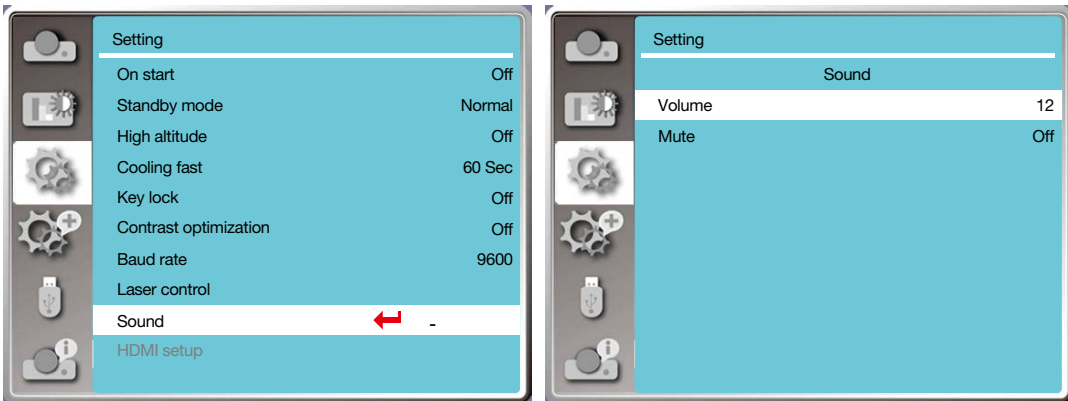

[HDMI setup]

When the external device is connected to the HDMI terminal of the projector, and the images can not be projected normally, please switch on the image or sound setting.

Press the MENU button on the remote control or on the top control panel to display the On-Screen menu. Press ▲▼ button to select the setting menu, then press the ENTER or ▶ button to enter the sub-menu.

- 1) Press ▲▼ button to select [HDMI setup] menu.
- 2) Press the ENTER button.
 - Display [HDMI setup] instantly.
- 3) Press ▲▼ button to select [Image] or [Sound]].
- 4) Press the ENTER button.

NOTE:

- HDMI setup option can be chosen only in HDMI 1 and HDMI 2 channel.

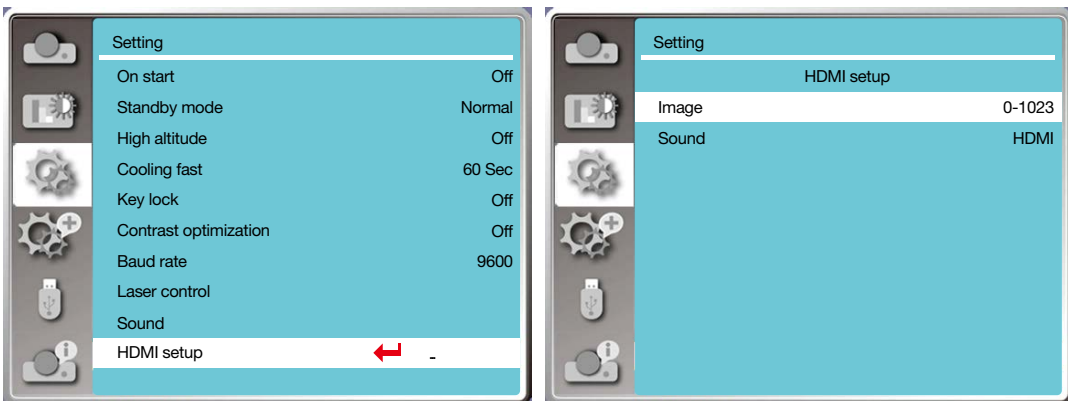

Image

Auto	Set the signal level automatically.
[64-940]	When external device (such as: a Blu-ray Disc player) is connected to the HDMI setup terminal .
[0-1023]	When the output of an external device (such as a computer), via a conversion cable or a similar cable, is connected to the HDMI setup terminal. Select this option when the output of the PC or any other device is connected to the HDMI setup terminal also.

Sound

[HDMI]	When connect to the HDMI cable to transmit images and audio while the users do not need connect to audio signal separately.
[Computer]	When the output of an external device (such as a computer), via a conversion cable or a similar cable ,is connected to the HDMI terminal . The audio signal would be output according the connection of AUDIO IN terminal.

7 Menu Descriptions & Functions [Expand]

The projector has expand function, you can select other functions as described below.

Menu operation

Press the MENU button on the remote control or on the top control panel to display the On-Screen menu. Press ▲ ▼ button to select the Expand menu, then press the ENTER or ► button.

- 1) Press ▲ ▼ button to select required item.
- 2) Press the ENTER button.
- 3) Press ▲ ▼ button to set options.
- 4) Press the ENTER button.



[Language]

Users can selected the language displayed on the screen.

- 1) Press ▲ ▼ button to select [Language] menu.
- 2) Press the ENTER button.
- 3) Press ▲ ▼ button to select required language.
- 4) Press the ENTER button.

Various menus, settings, adjustment screens, names of control panel keypads, etc., will be displayed in the selected language.

Your projector comes with multiple language support. You may select required one from them, such as: English, German, French, Italian, Spanish, Polish, Swedish, Dutch, Portuguese, Japanese, Simplified Chinese, Traditional Chinese, Korean, Russian, Arabic, Turkey, Finland, Norway, Denmark, Indonesia, Hungary, Czech Republic, Kazakhstan, Vietnamese, Thai, Farsi, Romaniaia.

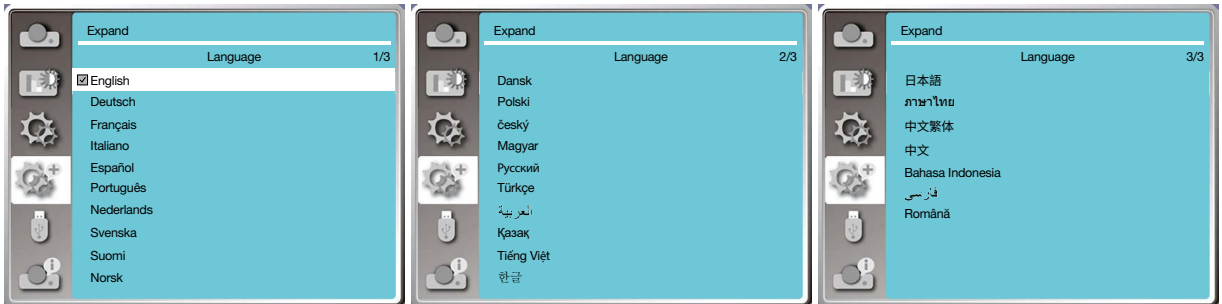

[Auto setup]

Select this function to store or reset the keystone or some related setting after unplugging the AC power. Press the MENU button on the remote control or on the top control panel to display the On-Screen menu. Press ▲ ▼ button to select the Expand menu, then press the ENTER or ► button. Press the AUTO ADJ. button on your remote control to execute the following functions: Input search, Auto PC adj. and Auto keystone.

- 1) Press ▲ ▼ button to select [Auto setup] menu.
- 2) Press the ENTER button.
- 3) Press ▲ ▼ button to select required items.

Input search: Select this function to detect the signal, then project images automatically.

Auto PC adj.: When Auto PC adj. is set to "On", the projector inputs an analog signal, then press the "Auto ADJ." button on the remote control to adjust [Fine sync], [H.Position], [V position] and [H. size] automatically.

When Auto PC Adjust is set to "Off", the "Auto ADJ." button on the remote control is invalid.

Auto keystone: Select this function to correct vertical distortion of the projected image automatically.

NOTE:

- Please adjust the projector manually, if the image is displayed abnormal even if you have selected Auto keystone function.
- When you set Project way as Ceiling / Front or Ceiling / Rear, Auto keystone function is invalid.
- When you set Project way as Auto ceiling / Front or Auto ceiling / Rear, and users put their projector in ceiling state, the Auto keystone function will be invalid.
- When select auto search for input source search, USB-A and LAN signals are not in the scope of auto search function.
- Input search function does not support signal input from BNC to VGA.

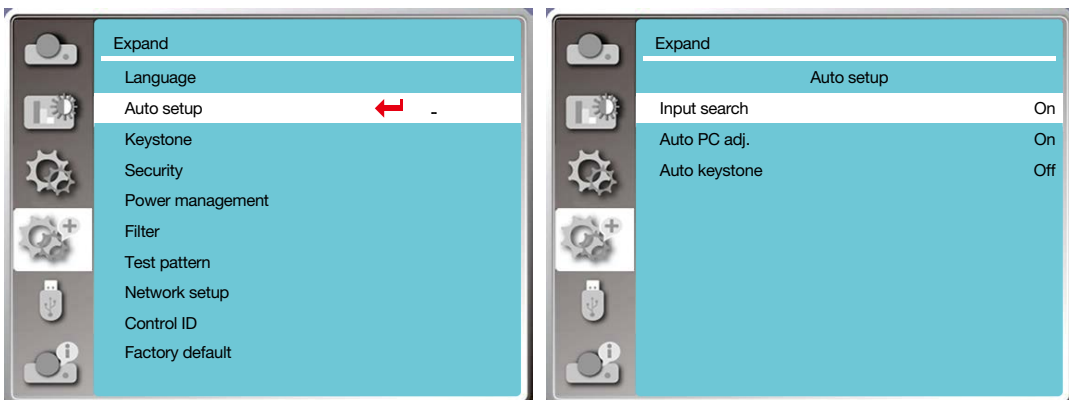

[Keystone]

Select this function to store or reset the keystone or some related setting after unplugging the AC power cord.

Press the MENU button on the remote control or on the top control panel to display the On-Screen menu. Press ▲ ▼ button to select the expand menu, then press the ENTER or ► button to enter.

- 1) Press ▲ ▼ button to select [Keystone] menu.
- 2) Press the ENTER button.
- 3) Press ▲ ▼ button to select required item.
- 4) Press the ENTER button.

Keystone

Select this function to store and reset keystone after turning off the projector or unplugging the AC power cord.

Store.....Store keystone after turning off the projector or unplugging the AC power cord.

Reset.....Keystone function will be canceled after turning off the projector or unplugging the AC power.

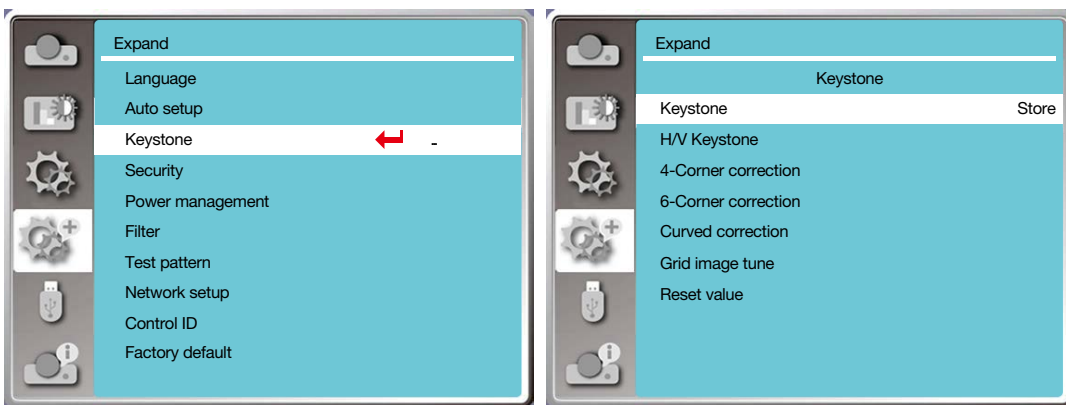

H/V Keystone

Select this function to correct the projected images horizontally or vertically.

Press ▲ button to
reduce upper width

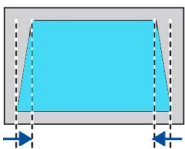

Press ▼ button to
reduce bottom width

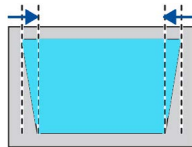

Press ◀ button to
reduce left width

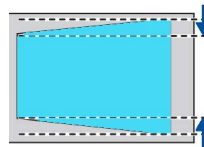

Press ▶ button to
reduce right width

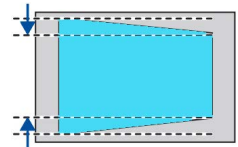

4-Corner correction

Select this function to correct the projected images of four corners distorted.

Press ▲ ▼ ◀ ▶ button to keystone at four corners of the screen. The four corners are looped in sequence shown below:

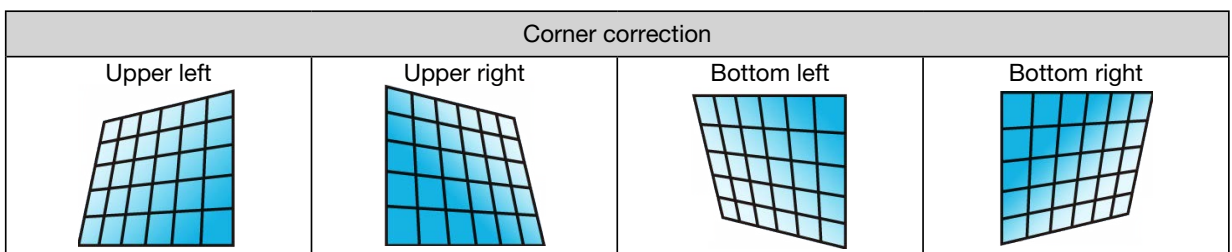

6-Corner correction

Select this function to correct the projected images of six corners distorted.

Press ▲▼◀▶ button to keystone at six corners of the screen. The six corners are looped in sequence shown below:

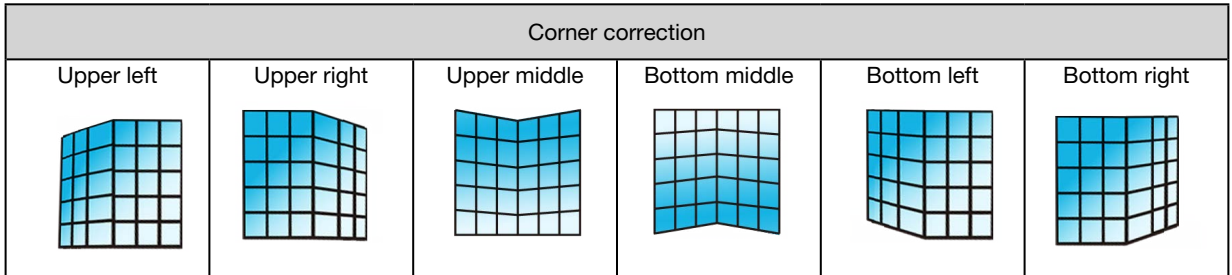

Curved correction

Select this function to correct the projected images with linearity uneven or vertical and horizontal bending deformation. press ▲▼◀▶ button to adjust options.

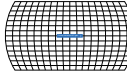
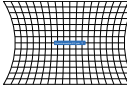
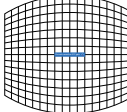
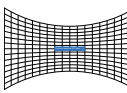
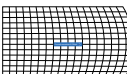
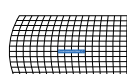
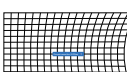
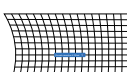
Item	Operation	Adjustment	
Curved correction X/Y gain	Press ◀	The lines on the left and right sides expand outward.	
	Press ▶	The lines on the left and right sides shrink inward.	
	Press ▼	The top and bottom lines expand outward.	
	Press ▲	The top and bottom lines shrink inward.	
Curved correction X offset	Press ◀	Correct the vertical line on the left. Extend the left vertical line outward while maintaining the right area.	
	Press ▶	Correct the vertical line on the right. Expand the right vertical line outward while maintaining the left area.	
	Press ◀	Correct the vertical line on the left. Extend the left vertical line outward while maintaining the right area.	
	Press ▶	Correct the vertical line on the right. Expand the right vertical line outward while maintaining the left area.	

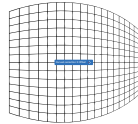
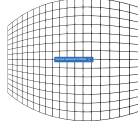
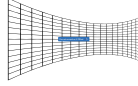
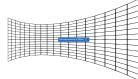
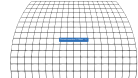
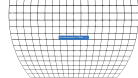
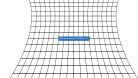
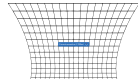
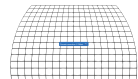
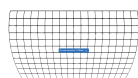
Curved correction X offset	Press ◀	Correct the horizontal line on the left. While maintaining the right area, expand the left top and bottom horizontal lines outward.	
	Press ▶	Correct the horizontal line on the right. While maintaining the left area, expand the top and bottom horizontal lines on the right.	
	Press ◀	Correct the horizontal line on the left. While maintaining the right area, expand the top and bottom vertical lines on the left.	
	Press ▶	Correct the horizontal line on the right. While maintaining the left area, expand the top and bottom horizontal lines on the right.	
Curved correction Y offset	Press ▼	Correct the vertical lines on the left and right sides. Extend the vertical lines on the left and right sides of the bottom while maintaining the top area.	
	Press ▲	Correct the vertical lines on the left and right sides. Extend the vertical lines on the left and right sides of the top while maintaining the bottom area.	
	Press ▼	Correct the vertical lines on the left and right sides. Extend the vertical lines on the left and right sides of the bottom while maintaining the top area.	
	Press ▲	Correct the vertical lines on the left and right sides. Extend the vertical lines on the left and right sides of the top while maintaining the bottom area.	
	Press ▼	Correct the horizontal line at the bottom. Extend the bottom horizontal line down while maintaining the top area.	
	Press ▲	Correct the horizontal line at the top. Expand the top horizontal line up while maintaining the bottom area.	

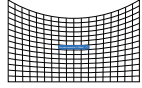
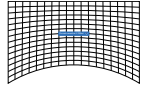
	Press ▼	Correct the horizontal line at the bottom. Extend the bottom horizontal line down while maintaining the top area.	
	Press ▲	Correct the horizontal line at the top. Expand the top horizontal line up while maintaining the bottom area.	

NOTE:

- After adjusting values about H/V keystone, if users adjust corner correction, values about H/V keystone will be reset. And after adjusting values about Corner correction, if users adjust about H/V keystone, values about Corner correction will be reset also.
- Curved correction X offset and Curved correction Y offset can not be adjusted individually. Adjust Curved correction X offset and Curved correction Y offset after adjusting the X/Y Curved correction.
- Maximum keystone range up to $\pm 30^\circ$ vertically and $\pm 30^\circ$ horizontally. However, the image quality will deteriorate, and become more difficult to focus. install the projector with the minimal correction value.
- The screen size will be changed with various H/V keystone adjustments.
- Keystone may influence image aspect.

Grid image tune

Select this function to adjust the local points of the projected image.

- 1) Press ▲▼◀▶ button to select [Grid image tune] option.
- 2) Press the ENTER button.

Reset

Select this function to make adjustment value back to the factory default.

- 1) Press ▲▼◀▶ button to select [Reset] option.
- 2) Press the ENTER button.
 - Release keystone mode.

[Security]

Set a PIN code to lock the usage of the projector to prevent unauthorized personnel from operating your projector. Once the projector is on, the [PIN code] screen will be displayed.

- 1) Press ▲▼ button to select [Security] menu.
- 2) Press the ENTER button.
- 3) Press ▲▼ button to switch required item.

PIN code lock

This function helps preventing unauthorized personnel from changing projector setting.

Off.....PIN code lock function is not available.

On.....The [PIN code] screen will appear when the projector is on. If you want to change the PIN code lock or PIN code (for three digits), you must enter the PIN code. The factory default PIN code is "111."

PIN code change

- You can change the PIN code. Click the ENTER button and select [PIN code change]. When the [PIN code] dialog box is displayed, press the ◀▶ button to enter a valid PIN code, and select [Set] to display the [New PIN code] dialog box. Set a new PIN code, confirm the contents in the dialog box, and select Set to set a new PIN code.
- The number you typed is displayed as "*". To edit number you have entered, press the MENU button to move the cursor to the number you want to change, press ◀▶ button to select the correct one.
- Repeat this step to type in a 3-digit number.
- Enter a three-digit number, move the cursor to [set]. Press the ENTER button, you can start to operate the projector.
- If the PIN code is invalid, the PIN code displayed as "***" will be in red. Please try again with a valid one.

- Please remember your new PIN code and keep it safe.

To cancel the PIN code

- (1) While simultaneously pressing the POWER button and the ENTER button on the projector, plug the power cord into the projector. After a while keep pressing the button, the PIN code input screen appears. Enter "111".
- (2) Select On-Screen menu [Security] >> [PIN code lock] >> "On". As the input screen appears again, enter the default value (111) and set the PIN code to "off" or set a new PIN code.

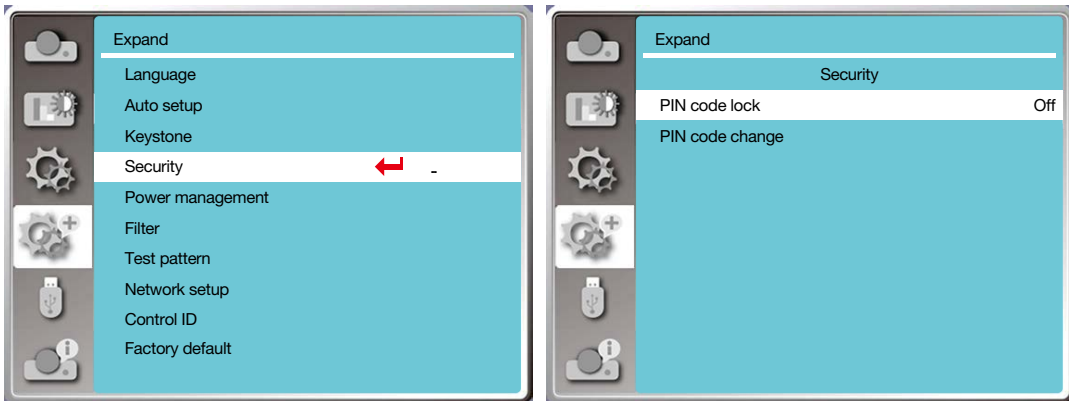

[Power management]

To reduce power consumption and maintain life cycle of light source, the power management function will turn off the projection light source if your projector has no signals for a period of time.

- 1) Press ▲ ▼ button to select [Power management] menu.
- 2) Press the ENTER button.
- 3) Press ▲ ▼ button to switch required item.

Ready.....The power light indicator turns steady green when the light source is fully cooled down. The light source turns on again if an input signal is connected or any button (except the power button) on the top control panel or remote control is pressed during this period of time.

Shut down.....The projector shut down after the light source is fully cooled down.

Off.....Disable the power management function.

Timer.....Once the input signal is interrupted and no buttons has been pressed for 30 seconds afterwards, the "No signal" message displays in the timer. The timer counts down until the light source turns off. Press arrow button to set up the timer in range of 1~30 minutes.

Ready countdown.....Set the interval from the Ready mode change to the Standby mode (0 to 30 minutes) automatically.

When it is set it to zero, the projector will never change automatically. Press the Power button to change your projector into the Standby mode and press any other button (except the Power button) to power on.

NOTE:

- Factory default for standby time: 5 minutes. Count down for ready mode: 5 minutes.
 - When selecting [Off], the [Timer] and [Ready countdown] is unavailable.
 - When selecting [Shut down], the [Timer] is unavailable.
-

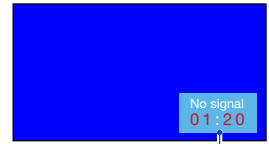
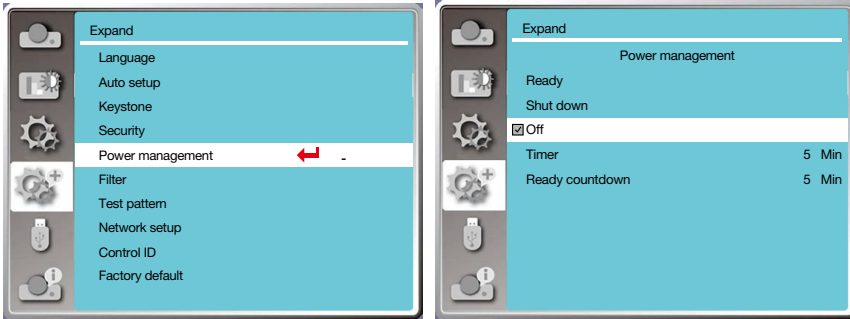

Remaining time before power off the light source.

[Filter]

Set this function to reset the filter usage time and set up warning display.

- 1) Press ▲▼ button to select [Filter] menu.
- 2) Press the ENTER button.
- 3) Press ▲▼ button to switch required item.

When the projector reaches the user-set cleaning time, filter warning icon will appear on the screen to notify the user to clean the projector filter. Reset the filter counter after cleaning it and filter warning icon will be closed.

Filter counter.....Displays the filter usage time.

Timer.....Set the time to display a warning icon.

Filter counter reset.....Reset filter counter.

NOTE:

- The screen will display the icon "Filter warning! Please change the filter!" when the projector has checks one warning. And the the warning icon will disappear 30 seconds later automatically, while only the Power button is effective during that period. The projector will give warning again if the projector has checked filter block and will record the information.

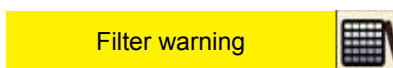
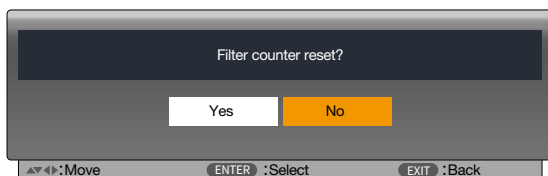
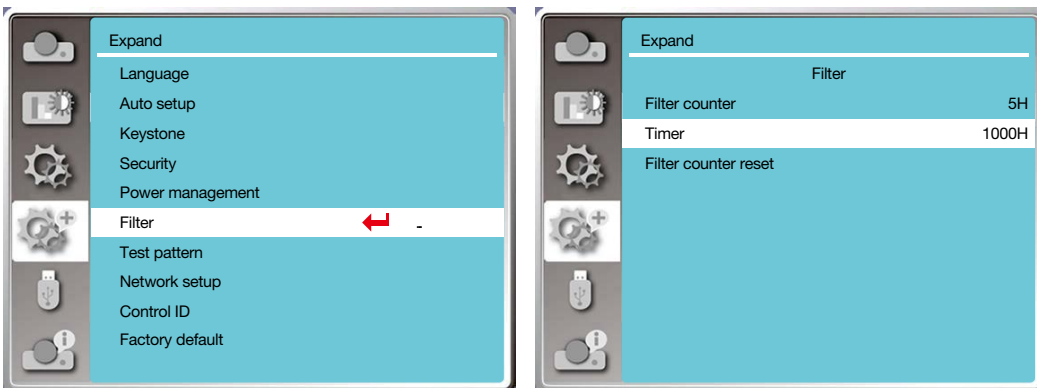

[Test pattern]

Select this function to display the projector's built-in test pattern.

- 1) Press ▲▼ button to select [Test pattern] menu.
- 2) Press the ENTER button.
- 3) Press ▲▼ button to switch required item.

4) Press the ENTER button.

Off / Gray scale 1 / Gray scale 2 / Gray scale 3 / Gray scale 4 / Color bar / Red / Green / Blue / Cross hatch / White / Black / Raster gray: Use the On-Screen menu to display the test pattern.

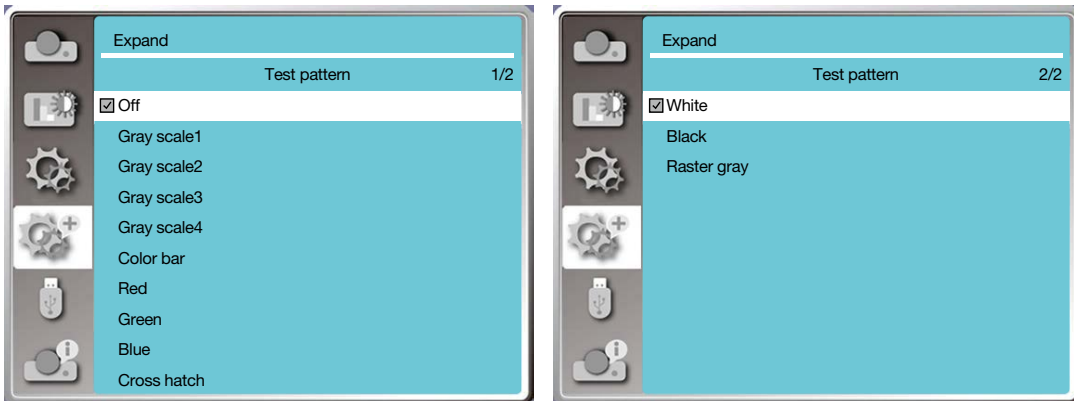

[Network setup]

Function: This function is designed to allow the computer control the projector remotely via network.

1.Required equipment: Projector, computer, network cable

2.Connection:

Connect the projector to the router or switch in the LAN with a straight or crossover network cable. If you connect the projector and the computer directly, you cannot connect with a straight-through network cable. It is recommended to use a crossover network cable.

3.Turn on the computer. The LAN port on computer and projector are flashing after turn on the projector.

NOTE:

- It is recommended that users use a Category 5 or higher LAN cable.

Operation steps

1. Turn on your projector.

2. Acquire the IP address, with DHCP set to on and auto IP allocation set to On. (You may set DHCP to Off and set up IP address manually if you are somehow familiar with networking.)

3. Enter the network setup menu.

(1) Press the MENU button on remote control or the top control panel, press ▲▼ button to select [Expand] icon. Press the ENTER or ► button.

(2) Press ▲▼ button select [Network setup] and press the ENTER button to enter.

MAC address.....Display the MAC address of wired LAN.

IP address.....Display the IP address of wired LAN.

(3) Press ▲▼ button select [Network setting] and press the ENTER button to enter.

(4) Press ▲▼ button to set DHCP "On" to obtain an IP address, Subnet, Gateway and DNS automatically, and press the ENTER button to confirm.

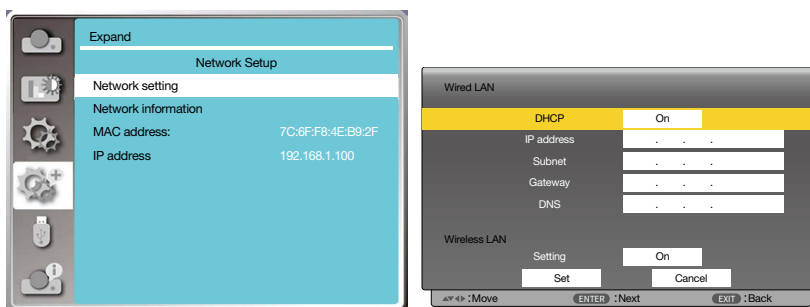

5. Using On-Screen Menu

Press the ▲▼ button to set DHCP "Off", then press the ENTER button to enter an IP address, then press ▼ button to select Subnet, Gateway and DNS manually. And press the ENTER button to confirm.

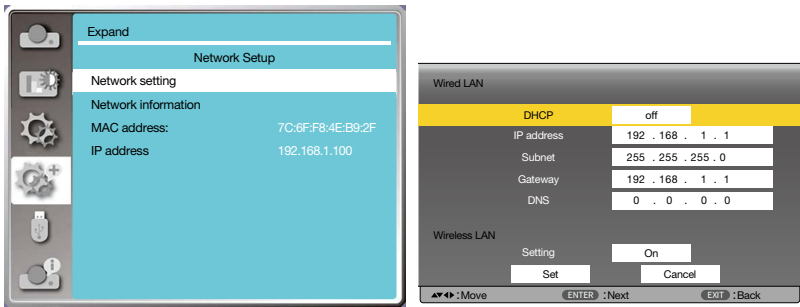

[Control ID]

Select this function to operate multiple projectors separately and independently with the single remote control that has the [Control ID] function. If you assign the same ID to all the projectors, you can conveniently operate all the projectors together using the single remote control. To do so, you have to assign an ID number to each projector.

- 1) Press ▲▼ button to select [Control ID] menu.
- 2) Press the ENTER button.
- 3) Press ▲▼ button to switch required item.
- 4) Press the ENTER button.

Control ID.....Select [Off] to turn off the [Control ID] setting and select [On] to turn on the [Control ID] setting.

Control ID Number.....Select a number from 1 to 254 you wish to assign to your projector.

NOTE:

- When [On] is selected for [Control ID], the projector cannot be operated by using the remote control that does not support the Control ID function. (In this case the buttons on the projector cabinet can be used.)

Assigning or Changing the Control ID

1. Turn on the projector.
2. Press the ID SET button on the remote control.
The Control ID screen will be displayed.

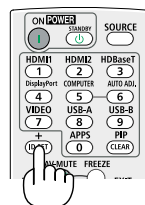
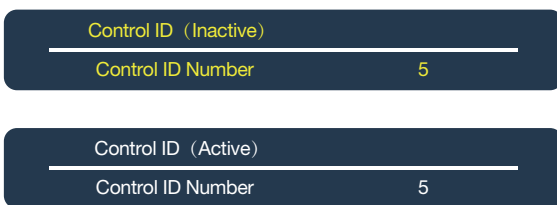

If the projector can be operated with the current remote control ID, the [Active] will be displayed. If the projector cannot be operated with the current remote control ID, the [Inactive] will be displayed. To operate the inactive projector, assign the control ID used for the projector by using the following procedure (Step 3).

3. Press one of numeric keypad buttons while pressing and holding the ID SET button on the remote control.

Example:

To assign "3", press the "3" button on the remote control.

No ID means that all the projectors can be operated together with a single remote control. To set "No ID", enter "000" or press the CLEAR button.

TIP: The range of IDs is from 1 to 254.

4. Release the ID SET button.

The updated Control ID screen will be displayed.

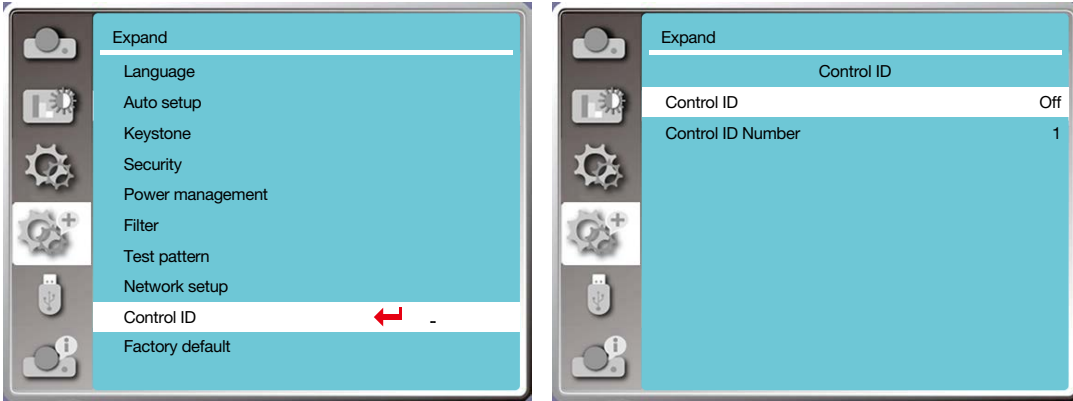

[Factory default]

This function resets all your settings to factory default.

- 1) Press ▲▼ button to select [Factory default] menu.
- 2) Press the ENTER or ► button.
- 3) Press ◀► button to select "Yes", then press the ENTER button.

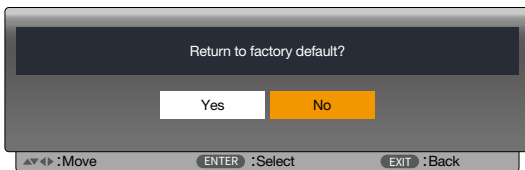

⑧ Menu Descriptions & Functions [USB-A]

The projector has expand function, you can select other functions as described below.

When the USB memory is inserted into the projector, the USB-A function can project pictures stored in the USB memory.

Press the MENU button on the remote control to display the On-Screen menu. Press the ▲▼ button to select the USB-A menu, then press the ENTER or ► button.

- 1) Press ▲▼ button to select required item.
- 2) Press the ENTER button.
- 3) Press ▲▼ button to set options.
- 4) Press the ENTER button.

NOTE:

- When selecting [USB-A] as input signal, the "USB-A" menu is available.
- In addition to "Set slide" menu, even change the settings, if you do not implement the [Apply], the setting value of the change is invalid.

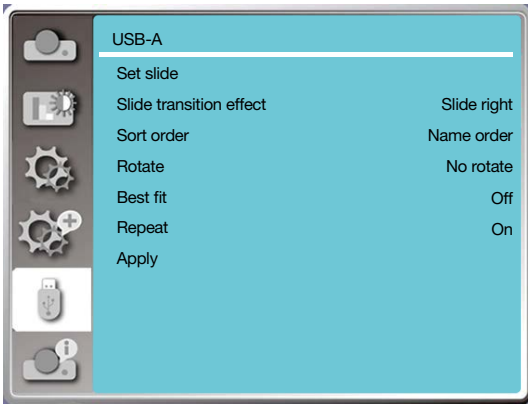

[Set slide]

Select this function to play slides.

- 1) Press ◀▶ button to select a file.
- 2) Press ▲▼ button to select [Set slide] menu.
- 3) Press the ENTER or ▶ button.
 - Full screen display
 - Press the ENTER to return to the thumbnail.

[Slide transition effect]

Select this function to set the slide's playback, when switching slides.

- 1) Press ▲▼ button to select [Slide transition effect] menu.
- 2) Press the ENTER or ▶ button.
- 3) Press ▲▼ button to switch required item.
 - Slide down.....Switch slides from top to bottom .
 - Slide right..... Switch slides from left to the right.

[Sort order]

Select this function to set the slide's order.

- 1) Press ▲▼ button to select [Sort order] menu.
- 2) Press the ENTER button.
- 3) Press ▲▼ button to switch required item.
 - Extend order..... Sort by extend names of file or folder.
 - Size order..... Sort by size of file or folder.
 - Time order..... Sort by the time of file or folder.
 - Name order..... Sort by names of file or folder.

[Rotate]

Set the rotation direction of images.

- 1) Press ▲▼ button to select [Rotate] menu.
- 2) Press the ENTER button.
- 3) Press ▲▼ button to switch required item.
 - No rotateRotation is invalid.
 - 270 degree.....Rotate clockwise by 270 degrees.
 - 180 degree.....Rotate clockwise by 180 degrees.
 - 90 degree.....Rotate clockwise by 90 degrees.

[Best fit]

Set the image to be compatible with projection screen.

- 1) Press ▲▼ button to select [Best fit] menu.
- 2) Press the ENTER button.
- 3) Press ▲▼ button to switch required item.
 - On.....Display image by the aspect ratio of the screen.

Off.....Display image by the normal pixels.

[Repeat]

Select this function to play images repeatedly.

- 1) Press ▲▼ button to select [Repeat] menu.
- 2) Press the ENTER or ► button.
- 3) Press ▲▼ button to switch required item.

On.....Replay the first image, after playing the last one.

Off.....Return to the thumbnail display screen, after playing the last image.

[Apply]

Only be used in playing slides.

- 1) Press ▲▼ button to select [Apply] menu.
- 2) Press the ENTER or ► button.

9 Menu Descriptions & Functions [Info.]

Select Info. function to detect the projected image signal and the projector operating status.

Press the HELP button on the remote control or the MENU button on the control panel to display the On-Screen menu. Press ▲▼ button to select the [Info.] menu, then press the ENTER or ► button.

Info. display as follows:

Input.....Display selected input source.

H- sync freq.....Display H- sync freq. of input signal in unit of KHz. Show “---KHz” when no signals are in existence.

V- sync freq.....Display V- sync freq. of input signal in unit of KHz. Show “---Hz” when no signals are in existence.

Light counter.....Display the light's usage time and remaining time in percentage .

Model name.....Display the projector's model name.

S/N.....Display the projector's serial number.

Firmware version.....Display the projector's firmware version.

SUBCPU.....Display the projector's SUBCPU's Version.

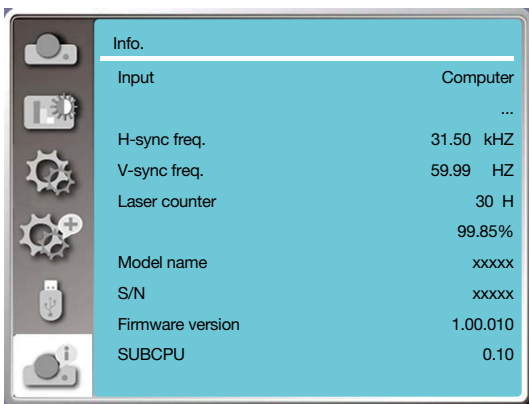

6. Network control

1 Network control operation

Function: This function is designed to remote control the projector from your computer in the same LAN.

Preparation

1. Required equipment: Projector, Computer, Network cable
2. Connection:
Connect the projector to the router or switch in the LAN with a straight or crossover network cable. If you connect the projector and the computer directly, you cannot connect with a straight-through network cable. It is recommended to use a crossover network cable.
3. Turn on the computer. The LAN port on computer and projector are flashing after turn on the projector.

NOTE:

- It is recommended that users use a Category 5 or higher LAN cable.

Operation steps

1. Turn on your projector.
2. Acquire the IP address, with DHCP set to "On" and auto IP allocation set to on. (You may set DHCP to "Off" and set up IP address manually if you are somehow familiar with networking.)
3. Enter the network setup menu.
 - (1) Press the MENU button on remote control or the top control panel, press ▲▼ button to select [Expand] icon. Press the ENTER or ► button.
 - (2) Press ▲▼ button select [Network setup] and press the ENTER button to enter.
MAC address.....Display the MAC address of wired LAN.
IP address.....Display the IP address of wired LAN.
 - (3) Press ▲▼ button select [Network setting] and press the ENTER button to enter.
 - (4) Press ▲▼ button to set DHCP "On" to obtain an IP address, Subnet , Gateway and DNS automatically, and press the ENTER button to confirm.

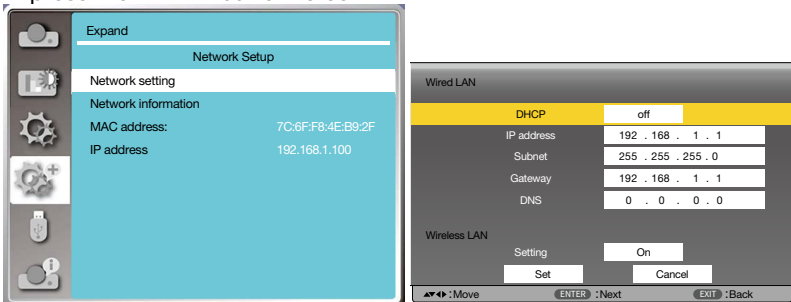

Press the ▲▼ button to set DHCP "Off", then press the ENTER button to enter an IP address, then press ▼ button to enter Subnet , Gateway and DNS manually. And press the ENTER button to confirm.

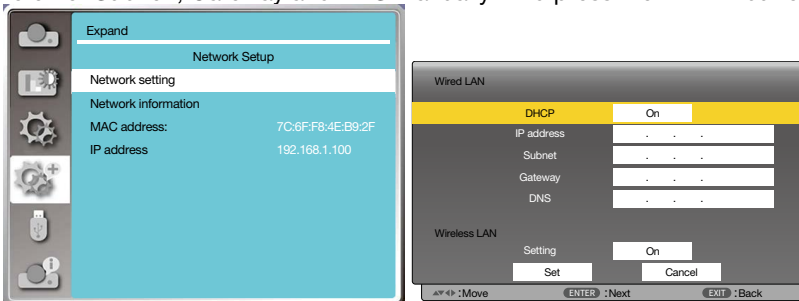

- (5) Press ▲▼ button to select [Set], press the ENTER button to wait until the "Please wait." message disappears.

NOTE:

- If you are using the wireless LAN connection, please check the SSID / ESSID and wireless IP address in the network setting status, and write down the information.

② Enter through a Web browser

Connecting Your Computer

- 1) Start the computer's Web browser.
- 2) Enter the IP address on the projector set in the URL input field of the Web browser. The "Network Display System" window for your projector will be displayed.
- 3) Click [Login] at the top left of the window.



- 4) Enter the password in the [Password], then click [Login]
 "*" the factory default setting is the user name: "admin" (administrator privileges), password: "admin".

NOTE:

- Users can click on the top right corner of the Web browser screen to select the display language and available languages are English, Japanese, Traditional Chinese, Simplified Chinese.
- Do not start multiple Web browser settings or control. Do not use more than one computer set or control the projector.
- Please change your password.
- If the network does not appear on screen controls, please consult your network administrator.
- Please refresh the web page before operating the projector.

Description of each option

Network Display System > System Status																	
①	System Status																
②	General Setup																
③	Picture Setup																
④	Image Setup																
⑤	Network Setup																
	<table border="1"> <tr> <td>Model Name</td> <td>NP-PE506UL</td> </tr> <tr> <td colspan="2">Versions</td> </tr> <tr> <td>Firmware Version</td> <td>1.00.010</td> </tr> <tr> <td colspan="2">LAN Status</td> </tr> <tr> <td>IP Address</td> <td>192.168.3.19</td> </tr> <tr> <td>Subnet</td> <td>255.255.255.0</td> </tr> <tr> <td>Gateway</td> <td>192.168.3.1</td> </tr> <tr> <td>Wire MAC Address</td> <td>00:20:00:20:00:20</td> </tr> </table>	Model Name	NP-PE506UL	Versions		Firmware Version	1.00.010	LAN Status		IP Address	192.168.3.19	Subnet	255.255.255.0	Gateway	192.168.3.1	Wire MAC Address	00:20:00:20:00:20
Model Name	NP-PE506UL																
Versions																	
Firmware Version	1.00.010																
LAN Status																	
IP Address	192.168.3.19																
Subnet	255.255.255.0																
Gateway	192.168.3.1																
Wire MAC Address	00:20:00:20:00:20																

- ① System status: Click this option to display the [System status] page.
- ② General setup: Click this option to display the [General setup] page.
- ③ Picture setup: Click this option to display the [Picture setup] page.
- ④ Image setup: Click this option to display the [Image setup] page.
- ⑤ Network setup: Click this option to display [Network setup] page.

3 [System status] page

Network Display System > System Status	
System Status	Model Name NP-PE506UL
General Setup	Versions
Picture Setup	Firmware Version 1.00.010
Image Setup	LAN Status
Network Setup	IP Address 192.168.3.19
	Subnet 255.255.255.0
	Gateway 192.168.3.1
	Wire MAC Address 00:20:00:20:00:20

- ① Versions: Displays the firmware version of the projector.
 ② LAN status: Displays the LAN connection status.

4 [General setup] page

Network Display System > General Setup	
System Status	Change Password for Webpage
General Setup	Enter Old password <input type="text"/>
Picture Setup	Enter New password <input type="text"/>
Image Setup	Confirm New password <input type="text"/>
Network Setup	<input type="button" value="Apply"/>
	Power & Source
	Power <input checked="" type="radio"/> On <input type="radio"/> Off
	Source Select HDMI-2

- ① Enter old password: Enter the password for the configuration.
 ② Enter new password: Enter a new password.
 ③ Confirm new password: Re-enter the new password to confirm.
 ④ Apply: Update settings.
 ⑤ Power: Switch on the power of the projector on / off.
 ⑥ Source select: Switch the input source of the projector.

5 [Picture setup] page

Network Display System > Picture Setup	
System Status	Brightness (0 --- 63) <input type="text" value="32"/>
General Setup	Contrast (0 --- 63) <input type="text" value="32"/>
Picture Setup	Sharpness (0 --- 15) <input type="text" value="0"/>
Image Setup	Color Temperature
Network Setup	Red (0 --- 63) <input type="text" value="32"/>
	Green (0 --- 63) <input type="text" value="32"/>
	Blue (0 --- 63) <input type="text" value="32"/>

- ① Brightness: Adjust the brightness of the projected image.
- ② Contrast: Adjust the contrast of the projected image.
- ③ Sharpness: Adjust the sharpness of the projected image.
- ④ Color Temperature: Adjust the color temperature of the projected image.

⑥ [Image setup] page

Network Display System > Image Setup

System Status	Aspect	Normal ▾	①
General Setup	Fine sync (0 --- 31)	- 0 +	②
Picture Setup	H Position	- 0 +	③
Image Setup	V Position	- 0 +	④
Network Setup	H Size (-15 --- 15)	- 0 +	⑤
	Freeze	<input type="radio"/> On <input checked="" type="radio"/> Off	⑥
	Auto PC adj.	<input type="checkbox"/>	⑦
	V Keystone (-60 --- 60)	- 0 +	⑧
	H Keystone (-60 --- 60)	- 0 +	⑨
	Corner correction TopLeft_x (0 --- 1279)	- 0 +	⑩
	Corner correction TopLeft_y (0 --- 799)	- 0 +	
	Corner correction TopRight_x (0 --- 1279)	- 1279 +	
	Corner correction TopRight_y (0 --- 799)	- 0 +	
	Corner correction BottomLeft_x (0 --- 1279)	- 0 +	
	Corner correction BottomLeft_y (0 --- 799)	- 799 +	
	Corner correction BottomRight_x (0 --- 1279)	- 1279 +	
	Corner correction BottomRight_y (0 --- 799)	- 799 +	

- ① Aspect: Switch the aspect ratio of the projected image.
- ② Fine sync: Adjust the phase of the projected image.
- ③ H position: Adjust the horizontal position of the projected image.
- ④ V position: Adjust the vertical position of the projected image.
- ⑤ H. size: Adjust the horizontal dimension of the projected image.
- ⑥ Freeze: Select the function to switch the screen freeze on and off.
- ⑦ Auto PC adj.: Implement the automatic computer adjustment function.
- ⑧ V keystone: Correct trapezoidal distortion in vertical direction.
- ⑨ H keystone: Correct horizontal distortion in horizontal direction.
- ⑩ Corner correction: Correct four angles of the projected image.

7 [Network setup] page

① Network setup

If you want to enable the DHCP client, select the IP address automatically.

IP address:

Please enter the IP address when you do not use the DHCP server.

Subnet :

Please enter a subnet shield when you do not use the DHCP server .

Gateway:

Please enter the gateway when you do not use the DHCP server.

DNS:

Please enter the DNS address, when you do not use the DHCP server.

Available character : digital (0 - 9), a period (.)

(For example: 192.168.0.253)

② Apply

Update settings.

③ Crestron control

Connect Crestron tool by setting IP address, IP ID and PORT options.

④ Wireless Setup

Wireless LAN: Please select wireless LAN on or off.

ESSID: Please enter the ESSID.

AP/AdHoc Encryption: Please select password set on or off.

AP/AdHoc key: Please set password.

⑤ PJLink setup

Input password: Input the PJLink password.

Confirm password: Input the PJLink password once again and confirm.

7. Installation and Connections

① Setting Up the Screen and the Projector

Use this to get a general idea of what the screen size will be when set in a certain position, what size screen you will need, and what distance you will need to project images of the desired size.

[PE506UL]

The projection distance range at which focusing is possible is 0.77 m (for 30 inches) to 12.89 m (for 300 inches). Install within this range.

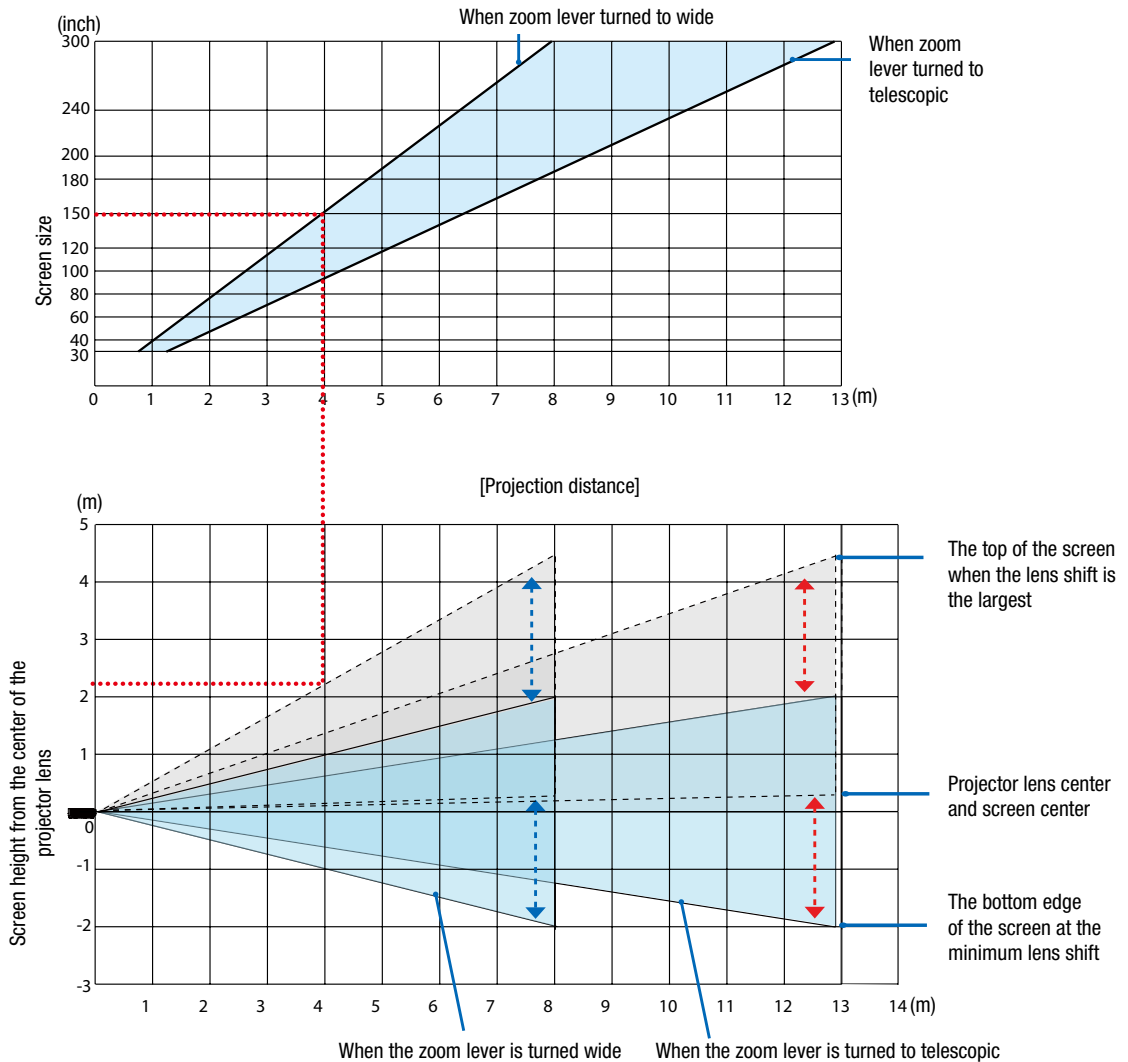

* The figures indicated for “height of screen from projector lens center” on the projection distance table are for a lens shift of 60% V.

Reading the Table

From the upper table on this page, to project wide images on a 150 screen, install at about 4.0 m from the front. Also, from the lower table we can see that about 2.2 m are required from the projector’s lens center to the upper edge of the screen. Use this to see whether or not enough height can be provided from the projector to the ceiling and for installing the screen. The diagram shows the projection distance when the projector is installed horizontally. The projected image can be moved up and down, left and right using the lens shift function. (→ [page 18](#))

7. Installation and Connections

[PE506WL]

The projection distance range at which focusing is possible is 0.78 m (for 30 inches) to 13.55 m (for 300 inches). Install within this range.

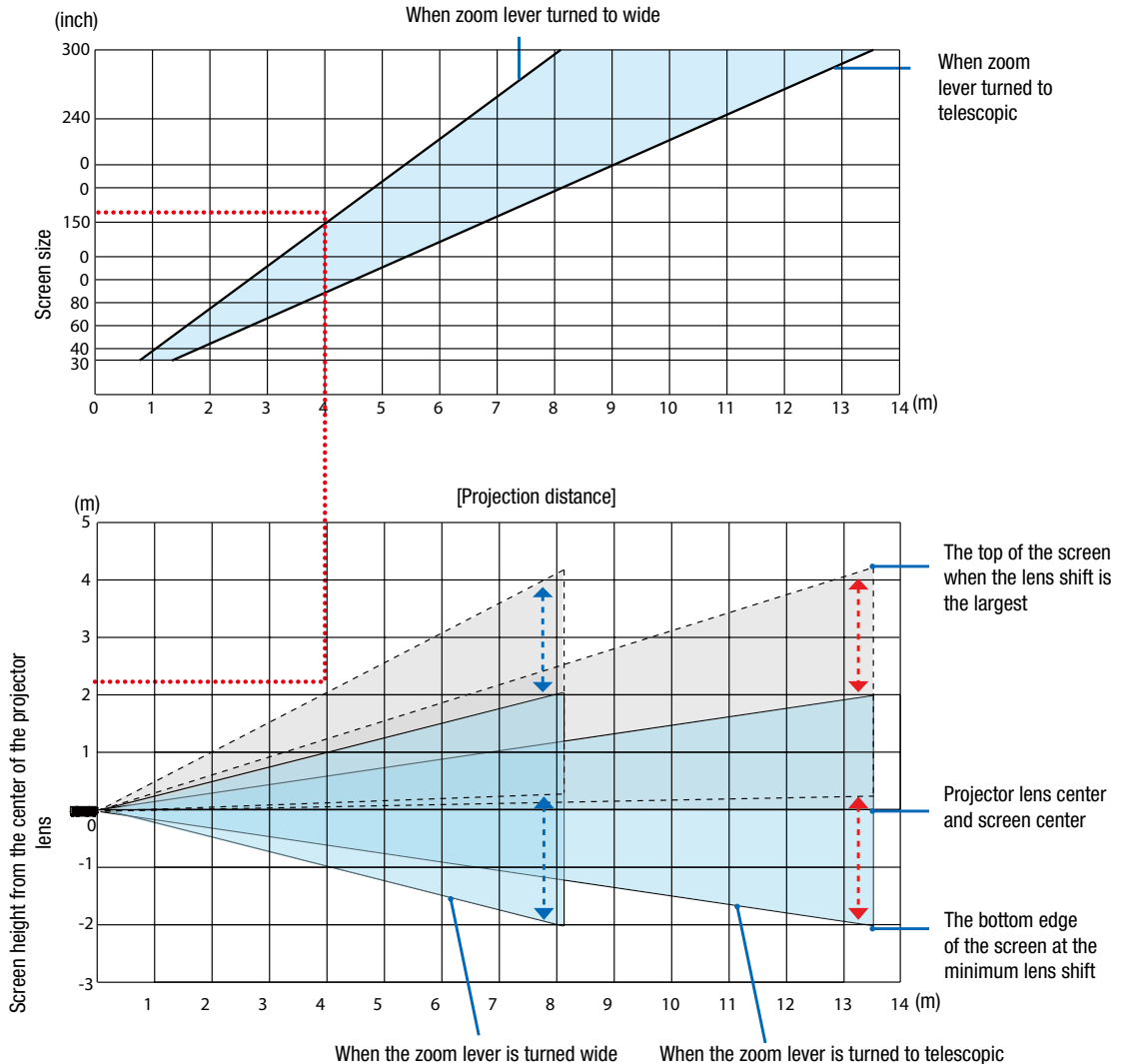

* The figures indicated for “height of screen from projector lens center” on the projection distance table are for a lens shift of 55% V.

Reading the Table

From the upper table on this page, to project wide images on a 150 screen, install at about 4.0 m from the front. Also, from the lower table we can see that about 2.1 m are required from the projector’s lens center to the upper edge of the screen. Use this to see whether or not enough height can be provided from the projector to the ceiling and for installing the screen. The diagram shows the projection distance when the projector is installed horizontally. The projected image can be moved up and down, left and right using the lens shift function. (→ [page 18](#))

Tables of screen sizes and dimensions

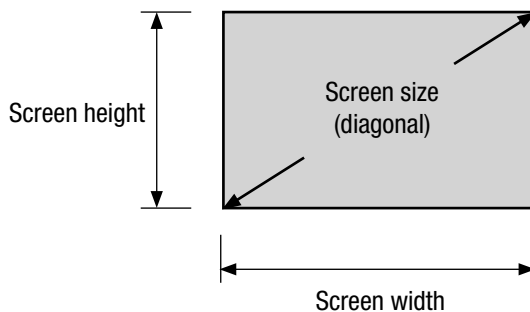

[PE506UL/PE506WL]

Size (inches)	Screen width		Screen height	
	(cm)	(inches)	(cm)	(inches)
30	64.6	25.4	40.4	15.9
40	86.2	33.9	53.8	21.2
50	107.7	42.4	67.3	26.5
60	129.2	50.9	80.8	31.8
80	172.3	67.8	107.7	42.4
100	215.4	84.8	134.6	53.0
120	258.5	101.8	161.5	63.6
150	323.1	127.2	201.9	79.5
200	430.8	169.6	269.2	106.0
250	538.5	212.0	336.5	132.5
300	646.2	254.4	403.9	159.0

Example of installation on a desktop

The diagram below shows an example of when the projector is used on a desktop.

Horizontal projection position: Equal distance to the left and right from the center of the lens vertical projection

position: (see table below)

[PE506UL]

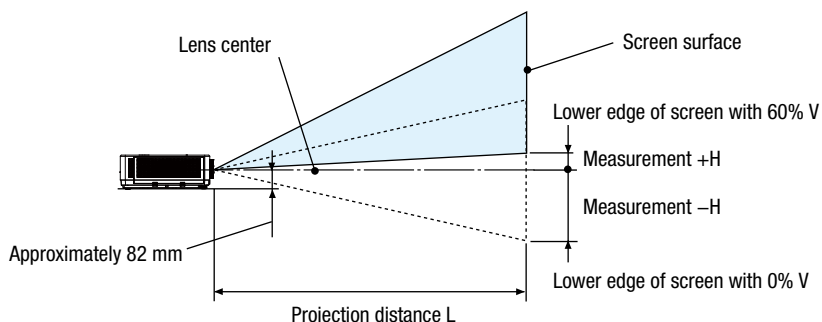

(NOTE) Height from lens center to lower edge of screen (with tilt feet screwed in)

Screen size (inches)	Throw distance L				Height H	
	(m)		(inches)		(cm)	(inches)
	Wide	Tele	Wide	Tele	0%V – 60%V	0%V – 60%V
30	0.77	1.26	30.1	49.5	-20.2 – +4.0	-7.9 – +1.6
40	1.03	1.69	40.6	66.5	-26.9 – +5.4	-10.6 – +2.1
60	1.56	2.55	61.6	100.4	-40.4 – +8.1	-15.9 – +3.2
80	2.10	3.41	82.6	134.3	-53.8 – +10.8	-21.2 – +4.2
90	2.36	3.84	93.1	151.3	-60.6 – +12.1	-23.8 – +4.8
100	2.63	4.27	103.6	168.2	-67.3 – +13.5	-26.5 – +5.3
120	3.16	5.13	124.6	202.1	-80.8 – +16.2	-31.8 – +6.4
150	3.96	6.43	156.1	253.0	-101.0 – +20.2	-39.7 – +7.9
180	4.76	7.72	187.6	303.8	-121.2 – +24.2	-47.7 – +9.5
200	5.30	8.58	208.6	337.8	-134.6 – +26.9	-53.0 – +10.6
250	6.36	10.30	250.5	405.6	-161.5 – +32.3	-63.6 – +12.7
270	7.16	11.59	282.0	456.4	-181.7 – +36.3	-71.5 – +14.3
300	7.96	12.89	313.5	507.3	-201.9 – +40.4	-79.5 – +15.9

7. Installation and Connections

[PE506WL]

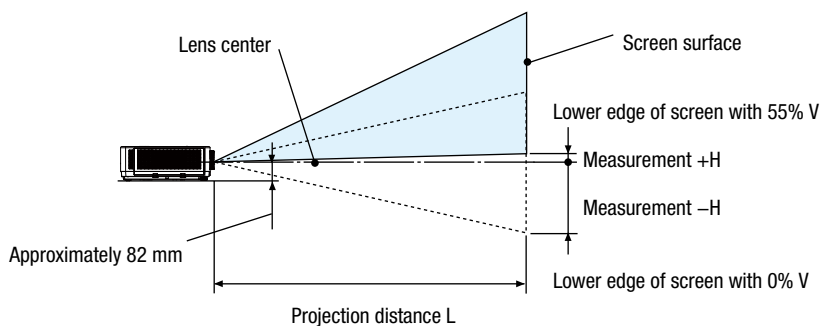

(NOTE) Height from lens center to lower edge of screen (with tilt feet screwed in)

Screen size (inches)	Throw distance L				Height H	
	(m)		(inches)		(cm)	(inches)
	Wide	Tele	Wide	Tele	0%V – 55 %V	0%V – 55%V
30	0.78	1.32	41.4	52.0	-20.2 – +2.0	-7.9 – +0.8
40	1.05	1.77	41.4	69.8	-26.9 – +2.7	-10.6 – +1.1
60	1.60	2.68	62.9	105.5	-40.4 – +4.0	-15.9 – +1.6
80	2.14	3.59	84.4	141.1	-53.8 – +5.4	-21.2 – +2.1
90	2.42	4.04	95.2	159.0	-60.6 – +6.1	-23.8 – +2.4
100	2.69	4.49	105.9	176.8	-67.3 – +6.7	-26.5 – +2.6
120	3.24	5.40	127.4	212.5	-80.8 – +8.1	-31.8 – +3.2
150	4.06	6.76	159.6	266.0	-101.0 – +10.1	-39.7 – +4.0
180	4.87	8.12	191.9	319.5	-121.2 – +12.1	-47.7 – +4.8
200	5.42	9.02	213.4	355.2	-134.6 – +13.5	-53.0 – +5.3
250	6.51	10.83	256.3	426.5	-161.5 – +16.2	-63.6 – +6.4
270	7.33	12.19	288.6	426.5	-181.7 – +18.2	-71.5 – +7.2
300	8.15	13.55	320.8	533.5	-201.9 – +20.2	-79.5 – +7.9

Lens shift range

This projector is equipped with a lens shift function (→ [page 18](#)) for adjusting the image position using dials. Lens shifting is possible within the range shown below.

NOTE:

- In case lens shifted volume exceeds the below illustrated range, blur and shade may appear around ends of projected image.

Legend: V “Vertical” refers to the screen height and H “Horizontal” refers to the screen width. The lens shift range is expressed as a ratio of height and width, respectively.

[PE506UL]

Lens shifting range:
 Vertical direction: +60%, -0%
 Horizontal direction: ±29%

DESKTOP FRONT, DESKTOP REAR

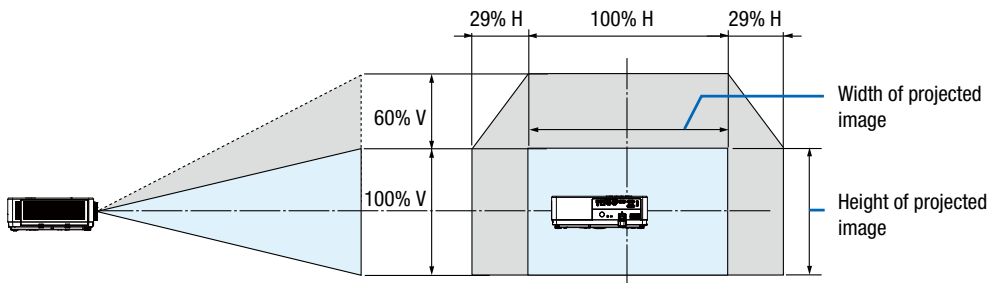

CEILING FRONT, CEILING REAR

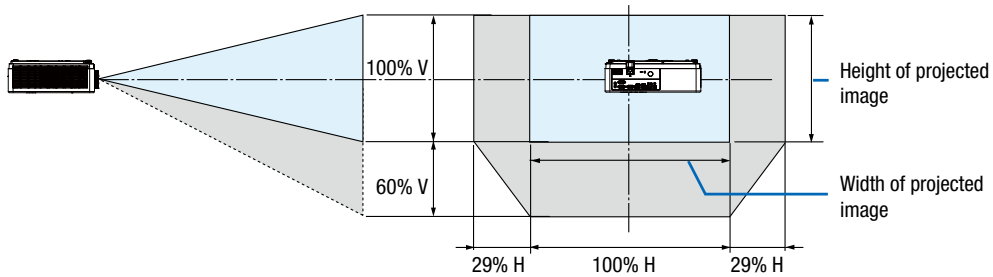

(Example) When using to project on a 150" screen

According to the “Table of screen sizes and dimensions” (→ [page 67](#)), $H = 127.2"/323.1 \text{ cm}$, $V = 79.5"/201.9 \text{ cm}$.
 Adjustment range in the vertical direction: the projected image can be moved upwards $0.60 \times 79.5"/201.9 \text{ cm} \approx 47.7"/121 \text{ cm}$ (when the lens is at the center position).

Adjustment range in the horizontal direction: the projected image can be moved to the left $0.29 \times 127.2"/323.1 \text{ cm} \approx 36.9"/94 \text{ cm}$, to the right approximately 36.9"/94 cm.

* Figures differ by several % because the calculation is approximate.

[PE506WL]

Lens shifting range:

Vertical direction: +55%, -0%

Horizontal direction: ±26%

DESKTOP FRONT, DESKTOP REAR

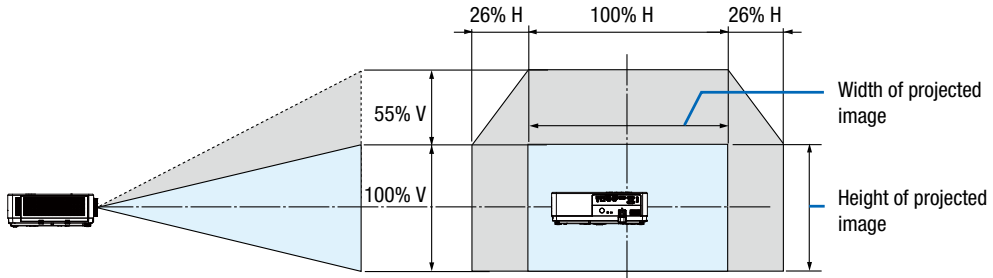

CEILING FRONT, CEILING REAR

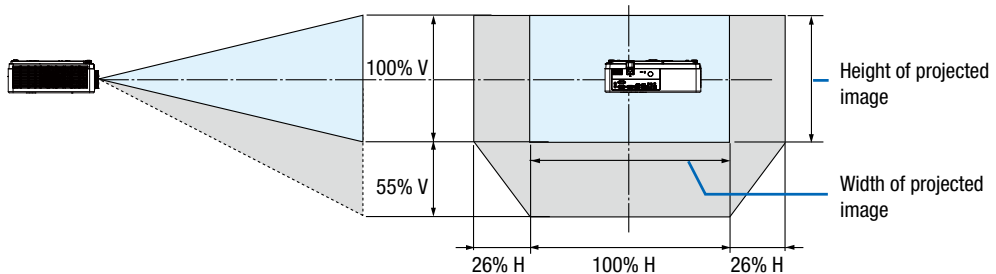

(Example) When using to project on a 150" screen

According to the "Table of screen sizes and dimensions" (→ page 67), $H = 127.2''/323.1 \text{ cm}$, $V = 79.5''/201.9 \text{ cm}$.

Adjustment range in the vertical direction: the projected image can be moved upwards $0.55 \times 79.5''/201.9 \text{ cm} \approx 43.7''/111 \text{ cm}$ (when the lens is at the center position).

Adjustment range in the horizontal direction: the projected image can be moved to the left $0.26 \times 127.2''/323.1 \text{ cm} \approx 33.1''/84 \text{ cm}$, to the right approximately $33.1''/84 \text{ cm}$.

* Figures differ by several % because the calculation is approximate.

2 Making Connections

Connecting Your Computer

Computer cable or HDMI can be used to connect to a computer. A computer cable (VGA) is supplied with the projector. Please get ready a suitable cable for the connection.

NOTE: Signals supported by Plug & Play (DDC2)

INPUT		
COMPUTER IN	HDMI 1 IN	HDMI 2 IN
analog	digital	digital
Yes	Yes	Yes

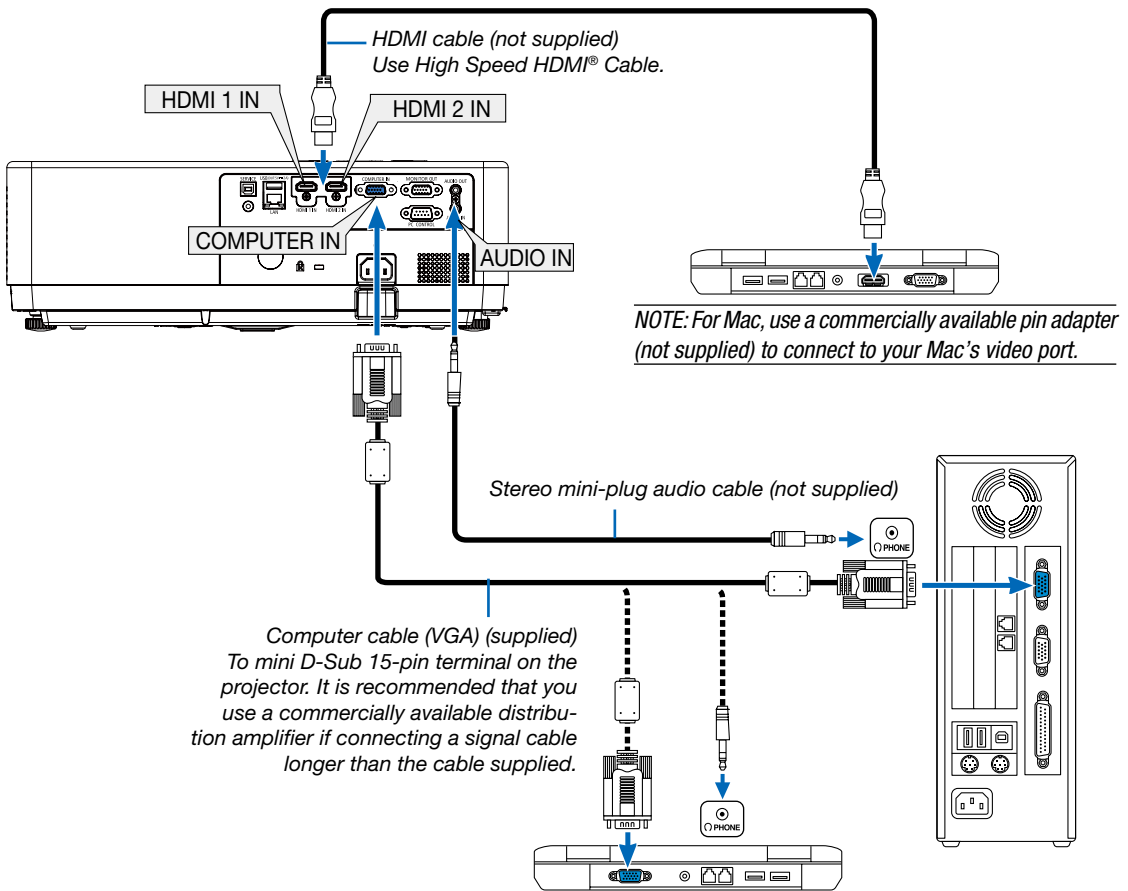

- Select the source name for its appropriate input terminal after turning on the projector.

Input terminal	INPUT button on the projector cabinet	Button on the remote control
COMPUTER IN	COMPUTER	(COMPUTER)
HDMI 1 IN	HDMI1	(HDMI 1)
HDMI 2 IN	HDMI2	(HDMI 2)

7. Installation and Connections

NOTE: The projector is not compatible with video decoded outputs of the NEC ISS-6020 switcher.

NOTE: An image may not be displayed correctly when a Video source is played back via a commercially available scan converter. This is because the projector will process a video signal as a computer signal at the default setting. In that case, do the following.

** When an image is displayed with the lower and upper black portion of the screen or a dark image is not displayed correctly:*

Project an image to fill the screen and then press the AUTO ADJ. button on the remote control or the projector cabinet.

Enabling the computer's external display

Displaying an image on the notebook PC's screen does not necessarily mean it outputs a signal to the projector.

When using a PC compatible laptop, a combination of function keys will enable/disable the external display.

Usually, the combination of the "Fn" key along with one of the 12 function keys gets the external display to come on or off. For example, NEC laptops use Fn + F3, while Dell laptops use Fn + F8 key combinations to toggle through external display selections.

Cautions when using a DVI signal

- When the computer has a DVI output terminal, use a commercially available converter cable to connect the computer to the projector's HDMI 1 or HDMI 2 input terminal (only digital video signals can be input).

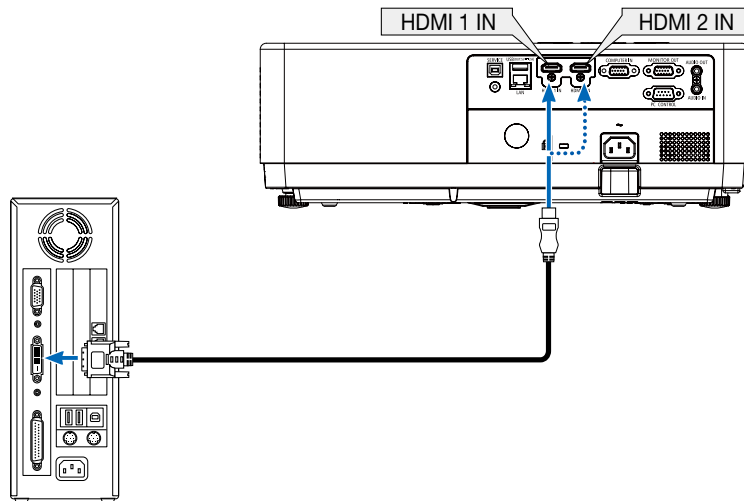

NOTE: When Viewing a DVI Digital Signal

- Turn off the power of the computer and projector before connecting.
- When a video deck is connected via a scan converter, etc., the display may not be correct during fast-forwarding and rewinding.
- Use a DVI-to-HDMI cable compliant with DDWG (Digital Display Working Group) DVI (Digital Visual Interface) revision 1.0 standard. The cable should be within 197"/5 m long.
- Turn off the projector and the PC before connecting the DVI-to-HDMI cable.
- To project a DVI digital signal: Connect the cables, turn the projector on, then select the HDMI input. Finally, turn on your PC. Failure to do so may not activate the digital output of the graphics card resulting in no picture being displayed. Should this happen, restart your PC.
- Do not disconnect the DVI-to-HDMI cable while the projector is running. If the signal cable has been disconnected and then reconnected, an image may not be correctly displayed. Should this happen, restart your PC.
- The COMPUTER video input terminals support Windows Plug and Play.
- A Mac signal adapter (commercially available) may be required to connect a Mac computer.

Connecting an External Monitor

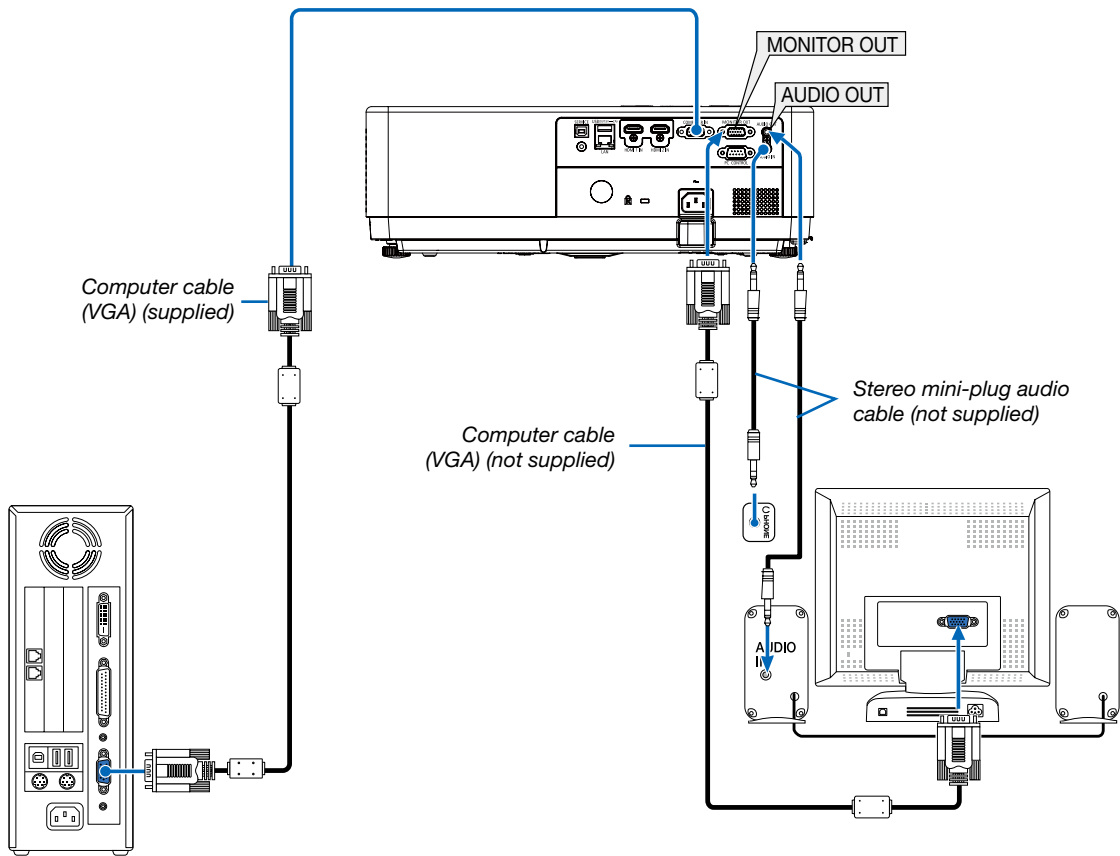

You can connect a separate, external monitor to your projector to simultaneously view on a monitor the computer analog image you're projecting.

NOTE:

- The AUDIO OUT mini jack does not support earphone/headphone terminal.
- When audio equipment is connected, the projector speaker is disabled.
- The signal output from the MONITOR OUT of this projector is for projecting image on exclusive one display.
- MONITOR OUT function is not available in Standby mode: Normal and Standby mode: Network standby.

Connecting Component Input

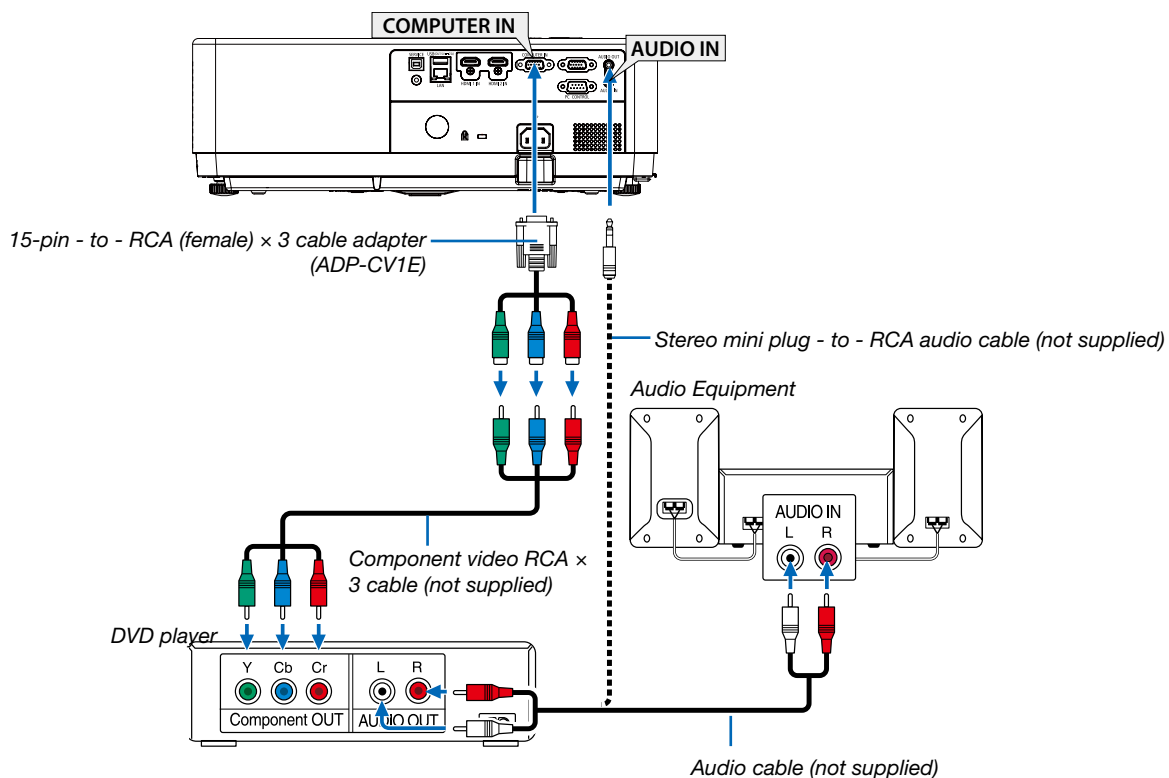

- Select the source name for its appropriate input terminal after turning on the projector.

Input terminal	INPUT button on the projector cabinet	Button on the remote control
COMPUTER IN	 COMPUTER	(COMPUTER)

NOTE: Refer to your DVD player's owner's manual for more information about your DVD player's video output requirements.



7. Installation and Connections

Connecting HDMI Input

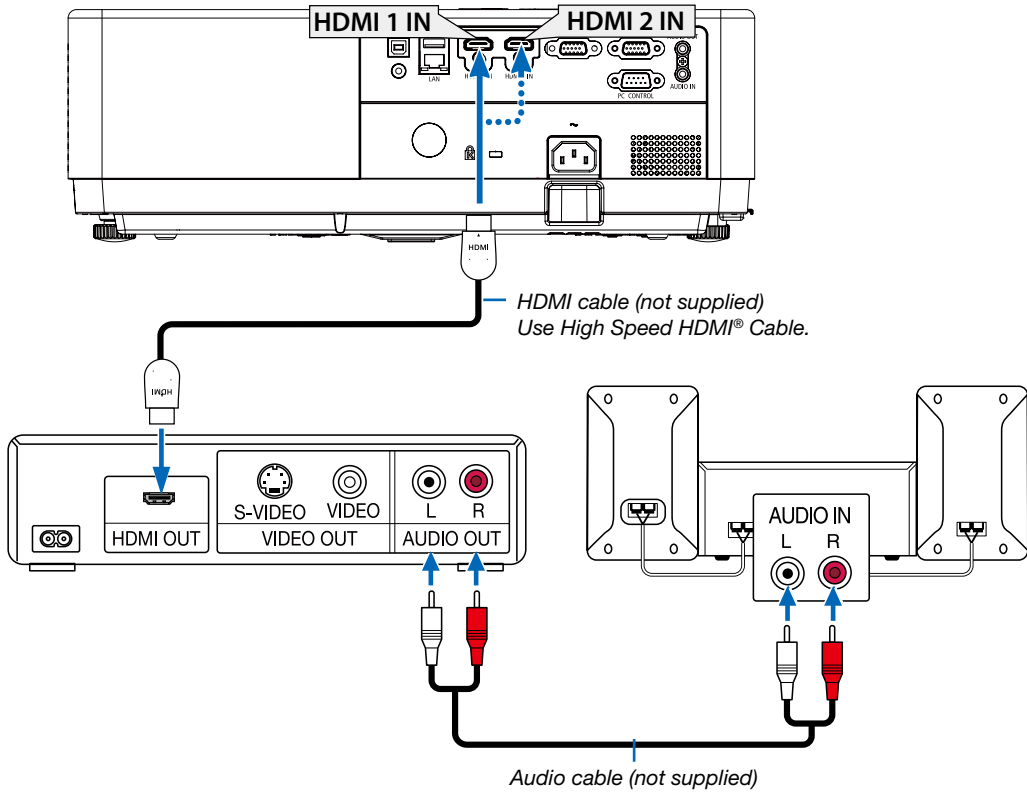
You can connect the HDMI output of your DVD player, hard disk player, Blu-ray player, or notebook type PC to the HDMI IN terminal of your projector.



- Select the source name for its appropriate input terminal after turning on the projector.

Input terminal	INPUT button on the projector cabinet	Button on the remote control
HDMI 1 IN	 HDMI1	(HDMI1)
HDMI 2 IN	 HDMI2	(HDMI2)

Connecting to a Wired LAN

The projector comes standard with a LAN port (RJ-45) which provides a LAN connection using a LAN cable. To use a LAN connection, you are required to set the LAN on the projector menu. (→ page 54)

Example of LAN connection

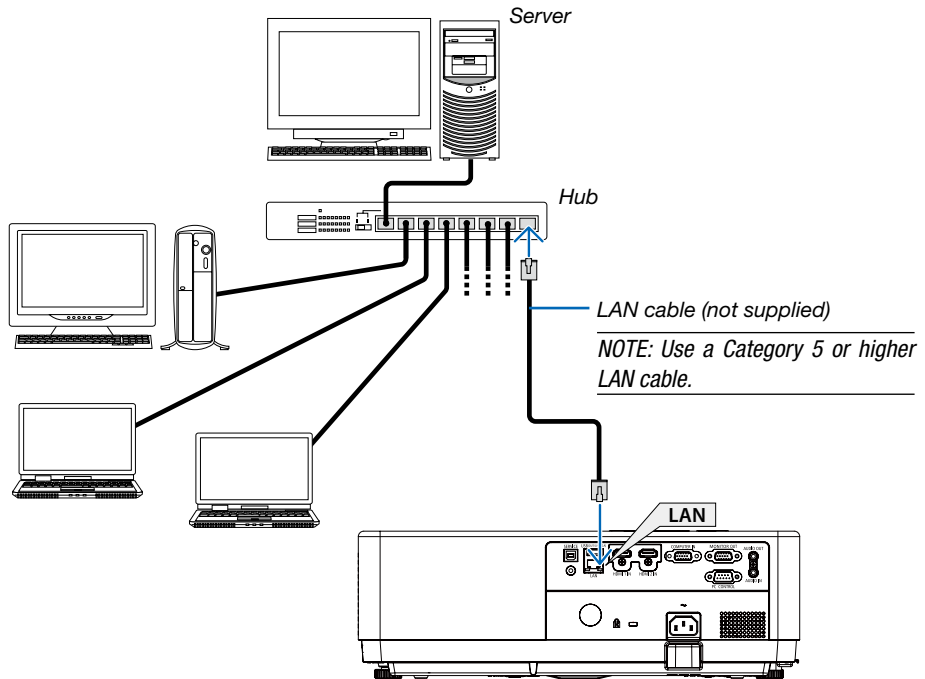

Connecting to a Wireless LAN

The USB Wireless LAN Unit also provides a wireless LAN connection.

Important:

- If you use the projector with the USB Wireless LAN Unit in the area where the use of wireless LAN equipment is prohibited, remove the USB Wireless LAN Unit from the projector.
- Buy the appropriate USB Wireless LAN Unit for your country or area.

NOTE:

- The green LED on the USB Wireless LAN Unit flashes to show that the USB Wireless LAN Unit is working.
- Your computer's wireless LAN adapter (or unit) must be complied with IEEE802.11b/g/n standard.
- When connecting a USB device and a network cable at the same time, there is highly possibility of interference when using a USB device that is too large..It is recommended that users use smaller USB devices.

Attaching the USB Wireless LAN Unit

NOTE:

- The USB Wireless LAN Unit must be inserted into the USB Wireless LAN Unit port in the correct direction. It cannot be inserted in the reverse direction. If the USB Wireless LAN Unit is inserted in the reverse direction with excessive force applied, the USB port may break.
- Before touching the USB Wireless LAN Unit, touch a metallic object (such as a door knob or aluminum window frame) to discharge the static electricity from your body.
- Always insert or remove the USB Wireless LAN unit when the main power is turned off. Failure to do so may cause projector malfunction or damage to the USB wireless LAN unit. If the projector will not work correctly, turn off the projector, disconnect the power cord, and then connect it again.
- The USB port of the projector is common use for the VIEWER. When the USB memory is installed and activate the VIEWER, you can not utilize wireless LAN.

7. Installation and Connections

1. Press the **POWER** button to turn off the projector and set it into standby condition, and disconnect the power cord.
2. Slowly insert the **USB Wireless LAN Unit** into the **USB port**. Remove the cap from the USB Wireless LAN Unit, and then insert it with the surface (side of indicator) facing down. Keep the cap for later use.

NOTE:

- Do not force to insert the USB Wireless LAN Unit.

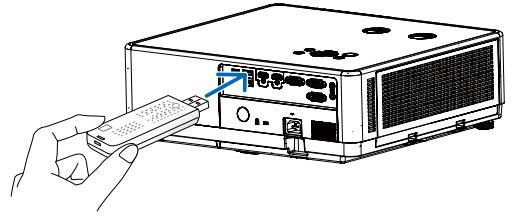

To remove the USB Wireless LAN Unit, disconnect the power cord and use the above procedure.

NOTE:

- The green LED on the USB Wireless LAN Unit flashes to show that Wireless LAN Unit is working. If the USB Wireless LAN Unit is incorrectly attached, the blue LED will not flash.
- Do not press the button on the USB Wireless LAN Unit. The button will not work with this model.

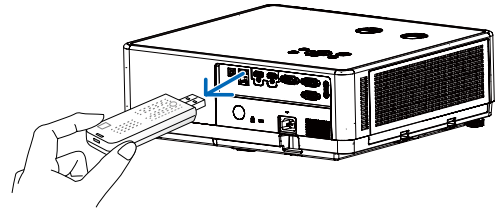

Connection Example [SIMPLE ACCESS POINT]

Set the projector as SIMPLE ACCESS POINT for connecting to terminals as computers and smart phones.

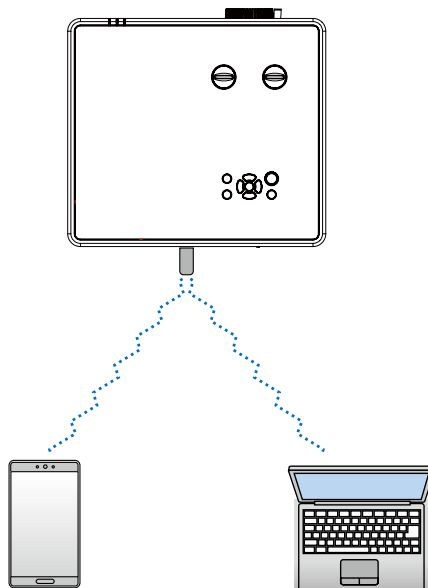

7. Installation and Connections

- (1) Press the MENU button on remote control or the top control panel, press ▲▼ button select [Expand] icon.
Press the ENTER or ► button.
- (2) Press ▲▼ button select [Network setup] and press the ENTER or ► button.
- (3) Press ▲▼ button select [Network setting] and press the ENTER button to enter.
- (4) Press ▲▼ button to set Wireless LAN Setting "On" and press the ENTER button to confirm.
- (5) Press ▲▼ button to select [Set], press the ENTER button to wait until the "Please wait.." message disappears.

NOTE:

- *Data transmission between wireless LAN and wired LAN is not possible.
up to 20 units can be connected simultaneously. Recommend to connect approx. 10 units for normal operation.*
-

8. Connecting with MultiPresenter app

① Things you can do by connecting the projector with MultiPresenter app

- You can send screen images via a wired LAN/wireless LAN from a terminal installed with our MultiPresenter app to the projector and project them onto a screen.
See our company's website for more details about MultiPresenter.
<https://www.sharp-nec-displays.com/dl/en/soft/multipresenter/index.html>
- Multiple computers or tablet terminals can be connected at the same time. A maximum of 16 units can be connected.

② Connecting to MultiPresenter

Preparations:

- When connecting the projector to a wired LAN, connect a LAN cable to the projector. (→ page 77)
- When connecting the projector to a wireless LAN, install a separately-sold LAN unit (NP05LM) in the projector. (→ page 77)
- Configure the NETWORK SETTINGS of the projector. (→ page 54)
- Install the MultiPresenter app in the computer or tablet terminal.
<https://www.sharp-nec-displays.com/dl/en/soft/multipresenter/index.html>

① When connecting using a Wired LAN

1. Turn on the projector and press the APPS button on the remote control.

The start-up screen of MultiPresenter is displayed.

2. Start MultiPresenter.

The target device screen is displayed.

3. Enter the 4-digit PIN code displayed in the start-up screen in the target device screen.

When connection with the projector is completed, the screen of the computer or tablet terminal is projected on the screen.

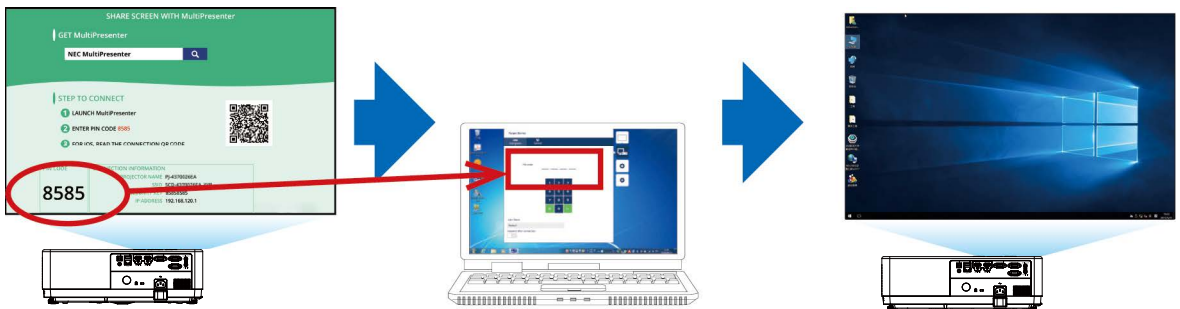

② When connecting using a Wireless LAN

1. Turn on the projector and press the APPS button on the remote control.

The start-up screen of MultiPresenter is displayed.

2. Connect your computer or tablet terminal to the access point matching the "SSID" displayed in the start-up screen.

3. Start MultiPresenter.

The target device screen is displayed.

4. Enter the 4-digit PIN code displayed in the start-up screen in the target device screen.

When connection with the projector is completed, the screen of the computer or tablet terminal is projected on the screen.

9. Maintenance

This section describes the simple maintenance procedures you should follow to clean the filter, the lens and the cabinet.

① Cleaning the Filter

The air-filter sponge keeps dust and dirt from getting inside the projector and should be frequently cleaned. If the filter is dirty or clogged, your projector may overheat.

⚠ WARNING

- Please do not use a spray containing flammable gas to remove dust attached to the filter, etc. Doing so may result in fires.

NOTE: The message for filter cleaning will be displayed for one minute after the projector is turned on or off. When the message is displayed, clean the filter. The time to clean the filter is set to [1000 H] at time of shipment.

To cancel the message, press any button on the projector cabinet or the remote control.

To clean the filter, detach the filter and the filter cover.

⚠ CAUTION

- Before cleaning the filter, turn off the projector, disconnect the power cord and then allow the cabinet to cool. Failure to do so can result in electric shock or burn injuries.

1. Push button to release the filter cover and pull it out.

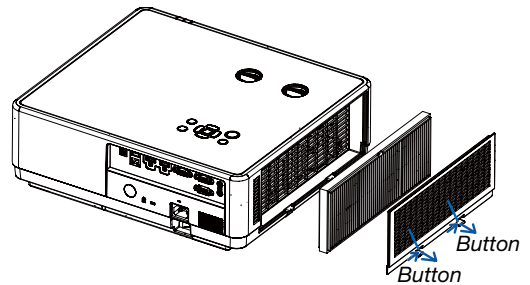

2. Remove the filter.

- Remove the filter from the filter cover.

3. Remove dust from the filter and the filter cover.

- Clean both outside and inside.

NOTE:

- Whenever you dust the filter, use the soft brush attachment to dust. This is to avoid damage to the filter.
- Do not wash the filter with water. Doing so can result in filter clogging.

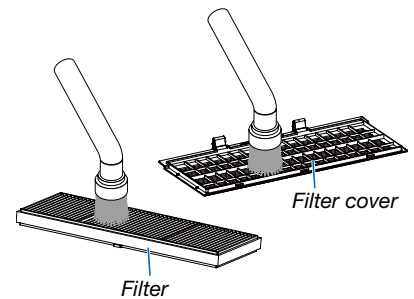

4. Attach the filter to the projector.

NOTE:

- When installing the filter, please make sure that the catch of the filter is facing outwards, otherwise the installation is reversed.

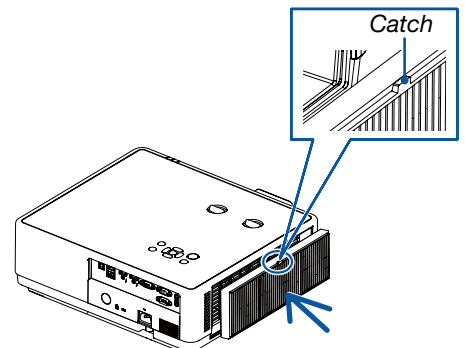

5. Put the filter cover back to the projector cabinet.

Insert the three catches of the tip of the filter cover into the groove of the cabinet, and then push the A button to close the filter cover.

- Push the filter cover until it clicks into place.

NOTE:

- After installing the filter cover to the cabinet, please press the left and right ends (B) of the filter cover manually to ensure that it is fully installed.

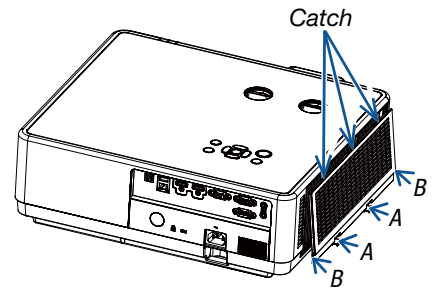

6. Clear the filter usage hours.

Plug the power cord into the wall outlet, and then turn on the projector.

From the menu, select [Filter] → [Filter counter reset].

(→ page 53)

The interval time to clean the filter is set to [1000H] at time of shipment. When using the projector as it is, you do not clear the filter usage.

② Cleaning the Lens

- Turn off the projector before cleaning.
- The projector has a plastic lens. Use a commercially available plastic lens cleaner.
- Do not scratch or mar the lens surface as a plastic lens is easily scratched.
- Never use alcohol or glass lens cleaner as doing so will cause damage to the plastic lens surface.

WARNING

- Please do not use a spray containing flammable gas to remove dust attached to the lens, etc. Doing so may result in fires.

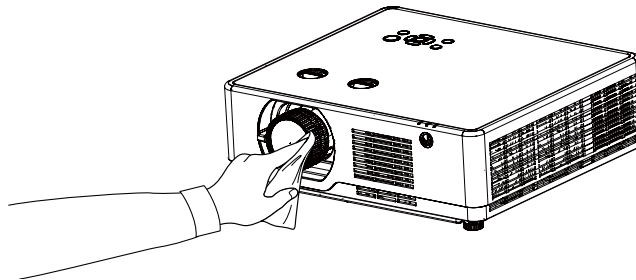

③ Cleaning the Cabinet

Turn off the projector, and unplug the projector before cleaning.

- Use a dry soft cloth to wipe dust off the cabinet.
If heavily soiled, use a mild detergent.
- Never use strong detergents or solvents such as alcohol or thinner.
- When cleaning the vents or the speaker using a vacuum cleaner, do not force the brush of the vacuum cleaner into the slits of the cabinet.

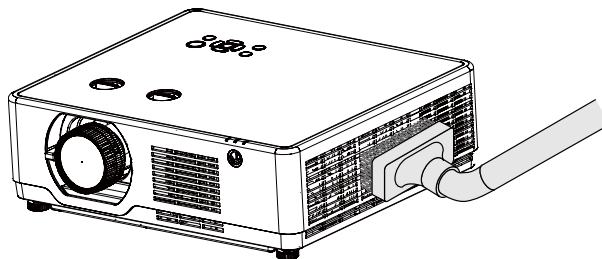

Vacuum the dust off the vents.

- Clogged vents may cause a rise in the internal temperature of the projector, resulting in malfunction.
- Do not scratch or hit the cabinet with your fingers or any hard objects.
- Contact your dealer for cleaning the inside of the projector.

NOTE: Do not apply volatile agent such as insecticide on the cabinet, the lens, or the screen. Do not leave a rubber or vinyl product in prolonged contact with it. Otherwise the surface finish will be deteriorated or the coating may be stripped off.

1 Troubleshooting

This section helps you resolve problems you may encounter while setting up or using the projector.

Common Problems & Solutions

Problem	Check These Items
Does not turn on or shut down	<ul style="list-style-type: none"> • Check that the power cord is plugged in and that the power button on the projector cabinet or the remote control is on. (→ page 11,12) • Check to see if the projector has overheated. If there is insufficient ventilation around the projector or if the room where you are presenting is particularly warm, move the projector to a cooler location. • The light module may fail to light. Wait a full minute and then turn on the power again. • Set [High altitude] to "On" when using the projector at altitudes approximately 5500 feet/1700 meters or higher. Using the projector at altitudes approximately 5500 feet/1700 meters or higher without setting [High altitude] to "On" can cause the projector to overheat and the projector could shut down. If this happens, wait a couple minutes and turn on the projector. (→ page 41) If you turn on the projector immediately after the light module is turned off, the fans run without displaying an image for some time and then the projector will display the image. Wait for a moment. • In case it's hard to think the trouble is not caused on the above mentioned conditions, unplug the power cord from the outlet. Then wait 5 minutes before plugging it in again. (→ page 23)
Will turn off	<ul style="list-style-type: none"> • Ensure that the [Power management] is "Off". (→ page 52)
No picture	<ul style="list-style-type: none"> • Check if the appropriate input is selected. (→ page 14) If there is still no picture, press the SOURCE button or one of the source buttons again. • Ensure your cables are connected properly. • Use menus to adjust the brightness and contrast. (→ page 39) • Check that the AV-MUTE (image off) buttons are not pressed. • Reset the settings or adjustments to factory default using the [Factory default] in the Expand Menu. (→ page 56) • Enter your registered keyword if the Security function is enabled. (→ page 51) • If the HDMI 1 IN or the HDMI 2 IN signal cannot be displayed, try the following. • - Reinstall your driver for the graphics card built in your computer, or use the updated driver. For reinstalling or updating your driver, refer to the user guide accompanied with your computer or graphics card, or contact the support center for your computer manufacturer. Install the updated driver or OS on your own responsibility. We are not liable for any trouble and failure caused by this installation. • Be sure to connect the projector and notebook PC while the projector is in standby mode and before turning on the power to the notebook PC. In most cases the output signal from the notebook PC is not turned on unless connected to the projector before being powered up. * If the screen goes blank while using your remote control, it may be the result of the computer's screen-saver or power management software. • See also the page 86.
Picture suddenly becomes dark	<ul style="list-style-type: none"> • Check for contrast and brightness settings. • Check for correct image mode settings.
Picture looks fuzzy	<ul style="list-style-type: none"> • Adjust the focus. (→ page 17) • Reposition the projector to improve its angle to the screen. (→ page 16) • Ensure that the distance between the projector and screen is within the adjustment range of the lens. (→ page 65) • Has the lens been shifted by an amount exceeding the guaranteed range? (→ page 70) • Condensation may form on the lens if the projector is cold, brought into a warm place and is then turned on. Should this happen, let the projector stand until there is no condensation on the lens.
Image isn't square to the screen	<ul style="list-style-type: none"> • Reposition the projector to improve its angle to the screen. (→ page 15) • Use the Keystone correction function to correct the trapezoid distortion. (→ page 20)

Image is scrolling vertically, horizontally or both	<ul style="list-style-type: none"> • Check the computer's resolution and frequency. Make sure that the resolution you are trying to display is supported by the projector. (→ page 95) • Adjust the computer image manually with the [H position] or [V position] in the [Display] menu. (→ page 34, 35)
Remote control does not work	<ul style="list-style-type: none"> • Install new batteries. (→ page 8) • Make sure there are no obstacles between you and the projector. • Stand within 23 feet (7 m) of the projector. (→ page 8) • The remote control sensor on the back of the projector cannot be used when the cable cover is mounted on the projector.
Indicator is lit or blinking	<ul style="list-style-type: none"> • See the POWER/STATUS/LIGHT Indicator. (→ page 87)
Control panel does not function	<ul style="list-style-type: none"> • Disable the key lock on control panel function in the Safety option of the Setup menu.
Cannot remove the Logo Select, Key Lock, and PIN code lock	<ul style="list-style-type: none"> • Please call your dealer or service center.
The Logo screen differs from the standard settings.	<ul style="list-style-type: none"> • Make sure you did not select "User" or "Off" in the Logo Select option of the Logo menu.

For more information contact your dealer.

If there is no picture, or the picture is not displayed correctly.

- Power on process for the projector and the PC. Be sure to connect the projector and notebook PC while the projector is in standby mode and before turning on the power to the notebook PC. In most cases the output signal from the notebook PC is not turned on unless connected to the projector before being powered up.

NOTE:

- You can check the horizontal frequency of the current signal in the projector's menu under Information. If it reads "0kHz", this means there is no signal being output from the computer. (→ page 59 or go to next step)

- Enabling the computer's external display.
Displaying an image on the notebook PC's screen does not necessarily mean it outputs a signal to the projector. When using a PC compatible laptop, a combination of function keys will enable/ disable the external display. Usually, the combination of the "Fn" key along with one of the 12 function keys gets the external display to come on or off. For example, NEC laptops use Fn + F3, while Dell laptops use Fn + F8 key combinations to toggle through external display selections.
- Non-standard signal output from the computer
If the output signal from a notebook PC is not an industry standard, the projected image may not be displayed correctly. Should this happen, deactivate the notebook PC's LCD screen when the projector display is in use. Each notebook PC has a different way of deactivate/reactivate the local LCD screens as described in the previous step. Refer to your computer's documentation for detailed information.
- Image displayed is incorrect when using a Mac
When using a Mac with the projector, set the DIPswitch of the Mac adapter (not supplied with the projector) according to your resolution. After setting, restart your Mac for the changes to take affect. For setting display modes other than those supported by your Mac and the projector, changing the DIP switch on a Mac adapter may bounce an image slightly or may display nothing. Should this happen, set the DIP switch to the 13" fixed mode and then restart your Mac. After that, restore the DIP switches to a displayable mode and then restart the Mac again.

NOTE:

- A Video Adapter cable manufactured by Apple Inc. is needed for a MacBook which does not have a mini D-Sub 15-pin terminal.





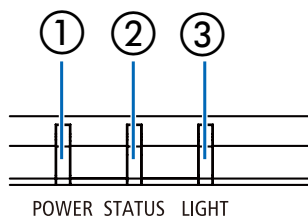



















- Mirroring on a MacBook
* When using the projector with a MacBook, output may not be set to the display resolution of the projector unless "mirroring" is off on your MacBook. Refer to owner's manual supplied with your Mac computer for mirroring.
- Folders or icons are hidden on the Mac screen
Folders or icons may not be seen on the screen. Should this happen, select [View] → [Arrange] from the Apple menu and arrange icons.

Feature of each indicator



- ① POWER indicator
This indicator informs the power status of the projector.
- ② STATUS indicator
This indicator lights/blinks when a button is pressed while the key lock function is utilized, or while performing the specific operations.
- ③ LIGHT indicator
This indicator informs the state of light source, usage time of the light source.

Indicator Message (Status message)

POWER	STATUS	LIGHT	Projector status
 Off	 Off	 Off	Power is off.
 Orange (Blink*2)	 Off	 Off	In the state of Standby (Standby mode is Normal standby).
 Orange (Light)	 Off	 Off	Standby state (Standby mode is Network standby).
 Orange (Blink*1)	 Off	 Off	In the state of Standby (Standby mode is Sleep standby).
 Blue (Light)	 Off	 Green (Blink*3)	Powered state (ECO mode:On).
 Blue (Light)	 Off	 Green (Light)	Powered state (ECO mode:Off).
 Green (Blink*4)	 Off	 Off	In the state of Cooling.
 Green (Light)	 Off	 Off	In the state of Sleep.



















































*1 Repetition to light on for 1.5 seconds / off for 1.5 seconds







*2 Repetition to light on for 1.5 seconds / off for 7.5 seconds

*3 Repetition to light on for 2.5 seconds / off for 0.5 seconds

*4 Repetition to light on for 0.5 seconds / off for 0.5 seconds

Indicator Message (Error message)

POWER	STATUS	LIGHT	Projector status	Procedure
 Off	 Orange (Light)	 Off	A button has been pressed while the KEY LOCK is activated.	The projector's keys are locked. The setting must be canceled to operate the projector. (→ page 42)
			ID numbers for the projector and the remote control do not match.	Check the control IDs (→ page 55)
 Red (Blink*4)	 Green (Light)	 Red (Light)	When LD-driver current value is too low	Please contact your dealer or service personnel.
 Red (Blink*4)	 Green (Blink*4)	 Red (Light)	When LD-driver SPI communication error	Please contact your dealer or service personnel.
 Red (Blink*4)	 Green (Light)	 Red (Blink*4)	When LD-driver 55V error	Please contact your dealer or service personnel.
 Red (Blink*4)	 Green (Blink*1)	 Red (Light)	When LD-driver 13V error	Please contact your dealer or service personnel.
 Red (Blink*4)	 Green (Light)	 Red (Blink*1)	When LD-driver output current is abnormal	Please contact your dealer or service personnel.
 Red (Blink*4)	 Green (Blink*3)	 Red (Light)	When LD-driver is not ready	Please contact your dealer or service personnel.
 Red (Blink*4)	 Green (Light)	 Red (Blink*3)	When LD-driver error	Please contact your dealer or service personnel.
 Red (Blink*4)	 Green (Blink*3)	 Red (Blink*3)	When Laser Cover switch Error	Please contact your dealer or service personnel.
 Red (Blink*4)	 Off	 Off	When Temperature status is error	Ambient temperature is out of the operation temperature. Check if any obstruction stays near the exhaust vent.
 Red (Light)	 Orange (Light)	 Off	When Fan-1 status is error	Please contact your dealer or service personnel.
 Red (Light)	 Orange (Blink*4)	 Off	When Fan-2 status is error	Please contact your dealer or service personnel.
 Red (Light)	 Off	 Orange (Blink*4)	When Fan-3 status is error	Please contact your dealer or service personnel.
 Red (Light)	 Orange (Blink*1)	 Off	When Fan-4 status is error	Please contact your dealer or service personnel.
 Red (Light)	 Off	 Orange (Blink*1)	When Fan-5 status is error	Please contact your dealer or service personnel.
 Red (Light)	 Orange (Blink*3)	 Off	When Fan-6 status is error	Please contact your dealer or service personnel.
 Red (Light)	 Red (Blink*4)	 Off	When power status is error	Please contact your dealer or service personnel.

POWER	STATUS	LIGHT	Projector status	Procedure
 Red (Blink*4)	 Red (Blink*4)	 Off	When phosphor wheel status is error	Please contact your dealer or service personnel.
 Red (Light)	 Red (Blink*3)	 Off	Filter over time Waring	Please clean up the filter and set filter counter reset. (→ page 53)

*1 Repetition to light on for 1.5 seconds / off for 1.5 seconds

*2 Repetition to light on for 1.5 seconds / off for 7.5 seconds

*3 Repetition to light on for 2.5 seconds / off for 0.5 seconds

*4 Repetition to light on for 0.5 seconds / off for 0.5 seconds

• When the thermal protector is activated:

When inside temperature of the projector becomes too high or low, the POWER indicator start to red blink in a short cycle. After this happened, the thermal protector will activate and the projector may be turned off.

In this case, please take the below measures:

- Pull out the power plug from the wall inlet.
- Place the projector in cool place if it has been placed in high ambient temperature.
- Clean the exhaust vent if dust has accumulated on.
- Leave the projector for about one hour until inside temperature gets lower.

② Specifications

This section provides technical information about projector's performance.

Optical

Model name	PE506UL	PE506WL
LCD Panel	0.64 inch LCD with Long Lens Array (aspect ratio 16:10)	0.64 inch LCD with Long Lens Array (aspect ratio 16:10)
Resolution*1	WUXGA (1920 dots × 1200 lines)	WXGA (1280 dots × 800 lines)
Lens	ZOOM Ratio=1.6 F=1.5-2.08 / f: 17.2mm~27.7mm	ZOOM Ratio=1.7 F=1.7-2.21 / f: 17.42mm~28.99mm
Zoom	Manual	
Focus	Manual	
Lens shift	H: ±29%, V: +60%, -0%	H: ±26%, V: +55%, -0%
Brightness*2	5200 lm	
Full Normal/Normal (%)	Approx. 100%	
ECO 1 (%)	Approx. 60%	
ECO 2 (%)	Approx. 50%	
Screen Size (Diagonal)	30-300 inches	
Projection Distance (Min.-Max.)	31.5inches- 507.9inches 0.8m-12.9m	31.5inches- 535.4inches 0.8m -13.6m
Projection Angle	0°-17.0° (Wide) 0°-10.8° (Tele)	0°-15.9° (Wide) 0°-9.6° (Tele)

*1 Effective pixels are more than 99.99%.

*2 This is the light output value (lumens) when the [Image mode] is set to [Dynamic] and the [ECO mode] is set to [Normal].
Compliance with ISO21118-2012

Electrical

Model name	PE506UL	PE506WL
Inputs	2 × HDMI Type A (19P, HDMI® Terminal) HDCP supported*3, 1 × Stereo Mini Audio, 1 × Mini D-Sub 15pin	
Outputs	1 × RGB (D-Sub 15 P), 1 × Stereo Mini Audio	
PC Control	1 × PC Control Port (D-Sub 9 P)	
Wired LAN Port	1 × RJ-45 (10BASE-T/100BASE-TX)	
Wireless LAN Port (Optional)	IEEE 802.11 b/g/n (optional USB Wireless LAN Unit required)	
USB Port	1 × Type A, 1 × Type B	
Color Reproduction	10-bit signal processing (1.07 billion colors) (VIEWER, Network: 16.7 million colors)	

*3 If you are unable to view material via the HDMI input input, this does not necessarily mean the projector is not functioning properly. With the implementation of HDCP technology, there may be cases in which certain content is protected with HDCP and might not be displayed due to the decision/intention of the HDCP community (Digital Content Protection, LLC).

Audio: LPCM; up to 2 ch, sample rate 32/44.1/48 KHz, sample bit; 16/20/24-bit

Model name	PE506UL	PE506WL	
Compatible Signals*4	Analog: VGA/SVGA/XGA/WXGA/Quad-VGA/SXGA/SXGA+/WXGA+/WXGA++/UXGA/WSXGA+/HD/Full HD/WUXGA Mac 13", 16", 23" Component: 480i/480p/576i/576p/720p/1080i/1080p HDMI: VGA/SVGA/XGA/WXGA/Quad-VGA/SXGA/SXGA+/WXGA+ /WXGA++/WSXGA+/4K/480p/576p/720p/1080i/1080p		
Horizontal Resolution	540 TV lines: NTSC/PAL 300 TV lines: SECAM		
Scan Rate	Horizontal: 15 kHz to 100 kHz (RGB: 24 kHz or over) Vertical: 24 Hz to 85 Hz		
Sync Compatibility	Separate Sync		
Built-in Speaker	1x16 W (monaural)		
Power Requirement	100 to 240 V AC, 50/60 Hz		
Input Current	4.5 -1.5A		
Power consumption	Full normal	352W(100V-130V)/ 335W(200-240 V)	330W(100V-130V)/ 319W(200-240 V)
	Normal	-	-
	ECO1 mode	228W(100V-130V)/ 219W(200-240 V)	212W(100V-130V)/ 203W(200-240 V)
	ECO2 mode	201W(100V-130V)/ 194W(200-240 V)	187W(100V-130V)/ 177W(200-240 V)
	Sleep (typ.) *5	7.7W(100V-130V)/ 7.8W(200-240 V)	
	Network stand-by (typ.)	0.7W(100V-130V)/ 0.8W(200-240 V)	
	Normal stand-by (typ.)	0.2W(100V-130V)/ 0.3W(200-240 V)	
	Network stand-by (for erp)	2.0W or less (100V-130V) / 2.0W or less (200-240 V)	
Normal stand-by (for erp)	0.5W or less (100V-130V) / 0.5W or less (200-240 V)		

*4 An image with higher or lower resolution than the projector's native resolution (PE506WL: 1280 × 800 / PE506UL: 1920 × 1200) will be displayed with Advanced AccuBlend. (→ page 95)

*5 All wired network ports are connected and active.

Mechanical

Model name	PE506UL	PE506WL
Installation Orientation	Desktop/Front, Desktop/Rear, Ceiling/Front, Ceiling/Rear	
Dimensions	405(W) * 372.8(D) * 137(H) (including protrusions)	405(W) * 358(D) * 137(H)(including protrusions)
Weight	17.53lbs(7.95 kg)	17.31lbs (7.85kg)
Environmental Considerations	Operational Temperatures: 0° to 40°C (32° to 104° F) 20% to 80% humidity (non-condensing) Storage Temperatures: -10° to 50°C (14° to 122°F) 20% to 80% humidity (non-condensing) Operating altitude: 0 to 3000 m/9800 f (Set [High Altitude] to [On]. approximately 1700 m/5500 f or higher.)	

For additional information visit:

US : <https://www.sharpnecdisplays.us>

Europe : <https://www.sharpnecdisplays.eu>

Global : <https://www.sharp-nec-displays.com/global/>

For information on our optional accessories, visit our website or see our brochure.

The specifications are subject to change without notice.

3 Cabinet Dimensions

Unit: mm (inch)

[PE506UL]

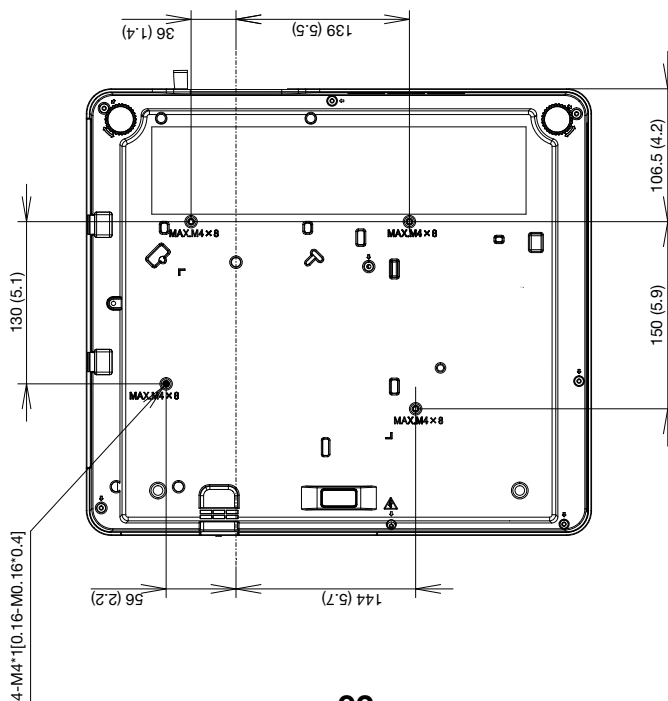
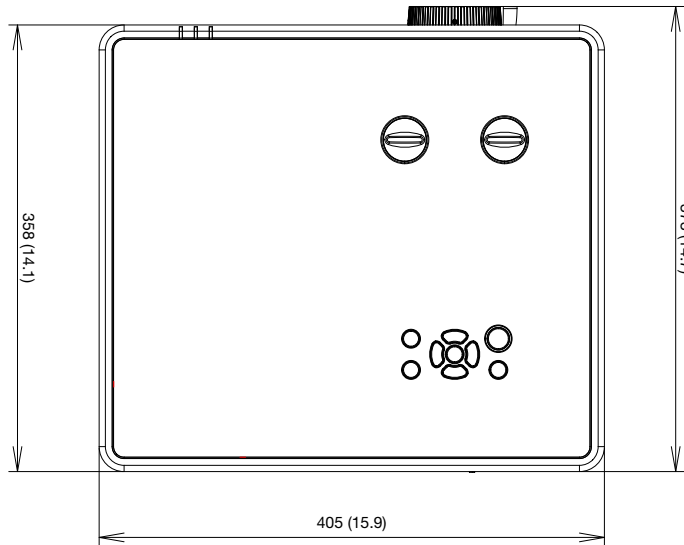
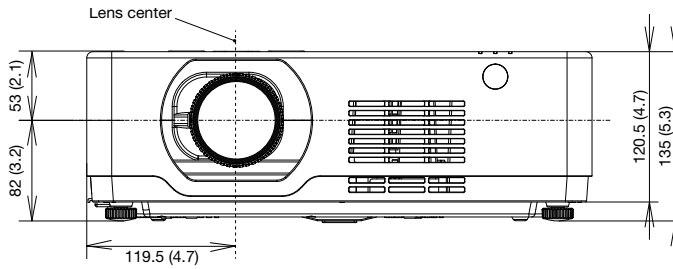

④ Pin Assignments of D-Sub COMPUTER Input Terminal

Mini D-Sub 15 Pin Terminal

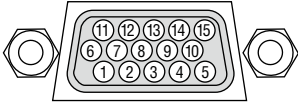

Signal Level

Video signal : 0.7Vp-p (Analog)

Sync signal : TTL level

Pin No.	RGB Signal (Analog)	YCbCr Signal
1	Red	Cr
2	Green or Sync on Green	Y
3	Blue	Cb
4	Ground	
5	Ground	
6	Red Ground	Cr Ground
7	Green Ground	Y Ground
8	Blue Ground	Cb Ground
9	Hotplug	
10	Sync Signal Ground	
11	No Connection	
12	Bi-directional DATA (SDA)	
13	Horizontal Sync or Composite Sync	
14	Vertical Sync	
15	Data Clock	

COMPUTER IN

NOTE: Pin Nos. 12 and 15 are required for DDC/CI.

5 Compatible Input Signal List

No	OSD Display	Source		Specification			
		RGB	HDMI	Resolution	Pixel clock (MHz)	H-freq(KHz)	V-freq(Hz)
1	720x480i 60Hz	○	-	720x480i	13.500	15.734	59.940
2	720x576i 50Hz	○	-	720x576i	13.500	15.625	50.000
3	720x480i 60Hz	-	○	720 (1440) x480i	27.000	15.734	59.940
4	720x576i 50Hz	-	○	720 (1440) x576i	27.000	15.625	50.000
5	720x483 60Hz	○	○	720x483(480P)	27.000	31.469	59.940
6	720x576 50Hz	○	○	720x576(576P)	27.000	31.250	50.000
7	1280x720p 60Hz	-	○	1280x720p	74.250	45.000	60.000
		○	○		74.176	44.955	59.940
8	1280x720p 50Hz	-	○		74.250	37.500	50.000
9	1920x1080i 60Hz	○	○	1920x1080i	74.250	33.750	60.000
		○	○		74.176	33.716	59.940
10	1920x1080i 50Hz	○	○		74.250	28.125	50.000
11	1920x1080p 24Hz	○	○	1920x1080p	74.250	27.000	24.000
		○	○		74.176	26.970	23.980
12	1920x1080p 60Hz	○	○		148.500	67.500	60.000
		○	○		148.352	67.433	59.940
13	1920x1080p 50Hz	○	○		148.500	56.250	50.000
14	640x480,60Hz	○	○	640x480	25.175	31.469	59.940
15	800x600,56Hz	○	-	800x600	36.000	35.156	56.250
16	1024x768,60Hz	○	○	1024x768	65.000	48.363	60.004
17	1280x720,60Hz	○	○	1280x720	74.500	44.772	59.855
18	1280x768,60Hz	○	○	1280x768	79.500	47.776	59.870
19	1280x800,60Hz	○	○	1280x800	83.500	49.702	59.810
20	1280x960,60Hz	○	○	1280x960	108.000	60.000	60.000
		○	-		126.000	75.000	75.080
21	1280x960,75Hz	○	-				
22	1280x1024,60Hz	○	○	1280x1024	108.000	63.981	60.020
23	1366x768,60Hz	○	○	1366x768	85.500	47.712	59.790
24	1400x1050,60Hz	○	○	1400x1050	121.750	65.317	59.978
25	1440x900,60Hz	○	○	1440x900	106.500	55.935	59.887
26	1600x1200,60Hz	○	○	1600x1200	162.000	75.000	60.000
27	1680x1050,60Hz	○	○	1680x1050	146.250	65.290	59.954
28	1920x1080,60Hz	○	○	1920x1080	148.500	67.500	60.000
29	1920x1200,60Hz	○	○	1920x1200	154.000	74.038	59.950
30	3840x2160,30Hz	-	○	3840x2160	297.000	67.500	30.000

NOTE:

“○” Shows input signal source support this format.

“-” Shows input signal source DO NOT support.

⑥ PC Control Codes and Cable Connection

PC Control Codes

Function	Code Data								
POWER ON	02H	00H	00H	00H	00H	02H			
POWER OFF	02H	01H	00H	00H	00H	03H			
INPUT SELECT COMPUTER	02H	03H	00H	00H	02H	01H	01H	09H	
INPUT SELECT HDMI1	02H	03H	00H	00H	02H	01H	1AH	22H	
INPUT SELECT HDMI2	02H	03H	00H	00H	02H	01H	1BH	23H	
INPUT SELECT USB-A	02H	03H	00H	00H	02H	01H	1FH	27H	
INPUT SELECT LAN	02H	03H	00H	00H	02H	01H	20H	28H	
PICTURE MUTE ON	02H	10H	00H	00H	00H	12H			
PICTURE MUTE OFF	02H	11H	00H	00H	00H	13H			
SOUND MUTE ON	02H	12H	00H	00H	00H	14H			
SOUND MUTE OFF	02H	13H	00H	00H	00H	15H			

NOTE: Contact your local dealer for a full list of the PC Control Codes if needed.

Cable Connection

Communication Protocol

Baud rate 4800/9600/19200/38400 bps
 Data length 8 bits
 Parity No parity
 Stop bit One bit
 X on/off None
 Communications procedure..... Full duplex

NOTE: Depending on the equipment, a lower baud rate may be recommended for long cable runs.

PC Control Terminal (D-SUB 9P)

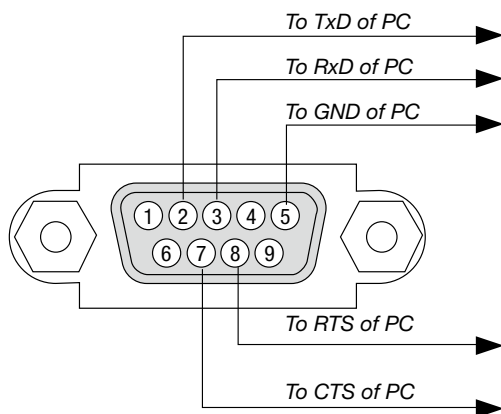

NOTE 1: Pins 1, 4, 6 and 9 are no used.

NOTE 2: Jumper "Request to Send" and "Clear to Send" together on both ends of the cable to simplify cable connection.

NOTE 3: For long cable runs it is recommended to set communication speed within projector menus to 9600 bps.

ABOUT THE ASCII CONTROL COMMAND

This device supports the common ASCII control Command for controlling our projector and monitor. Please visit our web site for detailed information about the command.

https://www.sharp-nec-displays.com/dl/en/pj_manual/lineup.html

HOW TO CONNECT WITH AN EXTERNAL DEVICE

There are two methods to connect the projector with an external device such as a computer.

1. Connection thru the serial port.
Connects the projector to a computer by a serial cable (a cross cable).
2. Connection via network (LAN)
Connects the projector to a computer by a LAN cable.
Concerning to the type of LAN cable, please ask to your network administrator.

CONNECTION INTERFACE

1. Connection thru the serial port.

Communication Protocol

Item	Information
Baud rate	4800/9600/19200/38400 bps
Data length	8 bits
Parity bit	No parity
Stop bit	1 bit
Flow control	None
Communications procedure	Full duplex

2. Connection via network

Communication Protocol (Connection via LAN)

Item	Information
Communication speed	Set automatically (10/100 Mbps)
Supported standard	IEEE802.3 (10BASE-T) IEEE802.3u (100BASE-TX, Auto-Negotiation)

Use the TCP port number 7142 for transmitting and receiving command.

PARAMETERS FOR THIS DEVICE

Input command

Input terminal	Response	Parameter
Computer	Computer	computer1, computer, rgb, rgb1, vga, vga1
HDMI1	HDMI1	hdmi1
HDMI2	HDMI2	hdmi2
USB-A	USB-A	usb-a
LAN	LAN	lan

Status command

Response	Error status
Error:temp	Temperature error
Error:fan	Fan trouble
Error:light	Light source trouble
Error:system	System trouble

7 Troubleshooting Check List

Before contacting your dealer or service personnel, check the following list to be sure repairs are needed also by referring to the “Troubleshooting” section in your user’s manual. This checklist below will help us solve your problem more efficiently.

* Print this page and the next page for your check.

Frequency of occurrence always sometimes (How often? _____) other (_____)

Power

- No power (POWER indicator does light orange). See also “Status Indicator (STATUS)”.
- Power cord’s plug is fully inserted into the wall outlet.
- No power even though you press and hold the POWER button.
- Shut down during operation.
 - Power cord’s plug is fully inserted into the wall outlet.
 - [Timer] is turned off.

Video and Audio

- No image is displayed from your PC or video equipment to the projector.
 - Still no image even though you connect the projector to the PC first, then start the PC.
 - Enabling your notebook PC’s signal output to the projector.
 - *A combination of function keys will enable/disable the external display. Usually, the combination of the “Fn” key along with one of the 12 function keys turns the external display on or off.*
 - No image (blue or black background, no display).
 - Still no image even though you press the AUTO ADJUST button.
 - Signal cable’s plug is fully inserted into the input terminal.
 - A message appears on the screen.
(_____)
 - The source connected to the projector is active and available.
 - Still no image even though you adjust the brightness and/or the contrast.
 - Input source’s resolution and frequency are supported by the projector.
- Image is too dark.
 - Remains unchanged even though you adjust the brightness and/or the contrast.
- Image is distorted.
 - Image appears to be trapezoidal (unchanged even though you carry out the [KEystone] adjustment).
- Parts of the image are lost.
 - Still unchanged even though you press the AUTO ADJUST button.
- Image is shifted in the vertical or horizontal direction.
 - Horizontal and vertical positions are correctly adjusted on a computer signal.
 - Input source’s resolution and frequency are supported by the projector.
 - Some pixels are lost.
- Image is flickering.
 - Still unchanged even though you press the AUTO ADJUST button.
 - Image shows flickering or color drift on a computer signal.
 - Still unchanged even though you change [High altitude] to [Off].
- Image appears blurry or out of focus.
 - Still unchanged even though you checked the signal’s resolution on PC and changed it to projector’s native resolution.
 - Still unchanged even though you adjusted the focus.
- No sound.
 - Audio cable is correctly connected to the audio input of the projector.
 - Still unchanged even though you adjusted the volume level.
 - AUDIO OUT is connected to your audio equipment (only models with the AUDIO OUT terminal).

Other

- Remote control does not work.
 - No obstacles between the sensor of the projector and the remote control.
 - Projector is placed near a fluorescent light that can disturb the infrared remote controls.
 - Batteries are new and are not reversed in installation.
 - ID for the projector and for the remote are same.
- Buttons on the projector cabinet do not work
 - [Key lock] is not turned on or is disabled in the menu.

⑧ REGISTER YOUR PROJECTOR! (for residents in the United States, Canada, and Mexico)

Please take time to register your new projector. This will activate your limited parts and labor warranty and InstaCare service program.

Visit our web site at <https://www.sharpnecdisplays.us>, click on support center/register product and submit your completed form online.

Upon receipt, we will send a confirmation letter with all the details you will need to take advantage of fast, reliable warranty and service programs from the industry leader, Sharp NEC Display Solutions of America, Inc.

NEC