



Digital Projector User Manual

EX600 / EW600 / EH600

V 1.01

Warranty and Copyright information

Limited warranty

BenQ warrants this product against any defects in material and workmanship, under normal usage and storage.

Proof of purchase date will be required with any warranty claim. In the event this product is found to be defective within the warranty period, BenQ's only obligation and your exclusive remedy shall be replacement of any defective parts (labor included). To obtain warranty service, immediately notify the dealer from which you purchased the product of any defects.

Important: The above warranty shall be void if the customer fails to operate the product in accordance with BenQ's written instructions, especially the ambient humidity must be in-between 10% and 90%, temperature in-between 0°C and 35°C, altitude lower than 4920 feet, and avoiding to operate the projector in a dusty environment. This warranty gives you specific legal rights, and you may have other rights which vary from country to country.

For other information, please visit www.BenQ.com.

Copyright

Copyright © 2020 by BenQ Corporation. All rights reserved. No part of this publication may be reproduced, transmitted, transcribed, stored in a retrieval system or translated into any language or computer language, in any form or by any means, electronic, mechanical, magnetic, optical, chemical, manual or otherwise, without the prior written permission of BenQ Corporation.

Disclaimer

BenQ Corporation makes no representations or warranties, either expressed or implied, with respect to the contents hereof and specifically disclaims any warranties, merchantability or fitness for any particular purpose. Further, BenQ Corporation reserves the right to revise this publication and to make changes from time to time in the contents hereof without obligation to notify any person of such revision or changes.

*DLP, Digital Micromirror Device and DMD are trademarks of Texas Instruments. Others are copyrights of their respective companies or organizations.

Patents

Please go to <http://patmarking.benq.com/> for the details on BenQ projector patent coverage.

Table of Contents

Warranty and Copyright information	2
Important safety instructions	4
Introduction	7
Shipping contents	7
Projector exterior view	9
Controls and functions.....	10
Positioning your projector	14
Choosing a location	14
Obtaining a preferred projected image size.....	15
Mounting the projector	17
Adjusting the projected image	18
Connection	20
Starting up the projector	22
Operation (under Launcher source)	26
Before you get started	26
The AMS Service	27
Checking for system update	33
BenQ Launcher	35
Operation (under non-Launcher source)	75
Using the projector menus under non-Launcher source	75
Securing the projector	76
Switching input signal	78
Menu operation	79
Shutting down the projector	94
Direct power off	94
Maintenance	95
Care of the projector	95
Light information	95
Troubleshooting	101
Specifications	102
Projector specifications	102
Dimensions	103
Timing chart.....	104
Appendix: Operation (under Launcher source) for firmware version before v01.00.19.00	107
BenQ Launcher	107

Important safety instructions

Your projector is designed and tested to meet the latest standards for safety of information technology equipment. However, to ensure safe use of this product, it is important that you follow the instructions mentioned in this manual and marked on the product.

1. **Please read this manual before you operate your projector.** Save it for future reference.

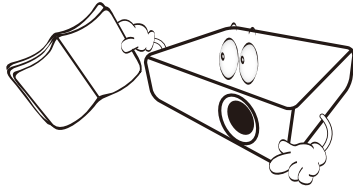

2. **Do not look straight at the projector lens during operation.** The intense light beam may damage your eyes.

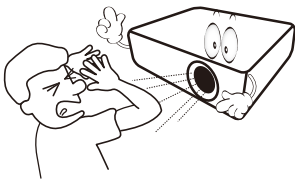

3. **Refer servicing to qualified service personnel.**

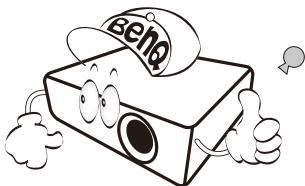

4. **Always open the lens shutter (if any) or remove the lens cap (if any) when the projector lamp is on.**

5. The lamp becomes extremely hot during operation. Allow the projector to cool for approximately 45 minutes prior to removing the lamp assembly for replacement.

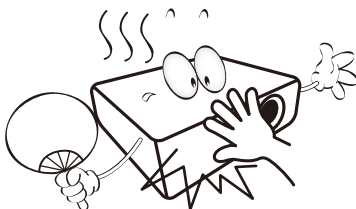

6. In some countries, the line voltage is NOT stable. This projector is designed to operate safely within a mains voltage between 100 to 240 volts AC, but could fail if power cuts or surges of ± 10 volts occur. **In areas where the mains voltage may fluctuate or cut out, it is recommended that you connect your projector through a power stabilizer, surge protector or uninterruptible power supply (UPS).**

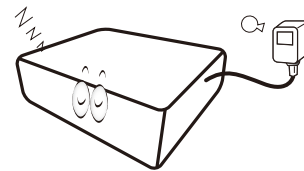

7. Do not block the projection lens with any objects when the projector is under operation as this could cause the objects to become heated and deformed or even cause a fire. To temporarily turn off the lamp, use the blank function.

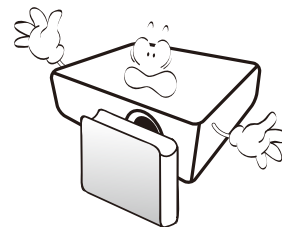

8. Do not operate lamps beyond the rated lamp life. Excessive operation of lamps beyond the rated life could cause them to break on rare occasions.

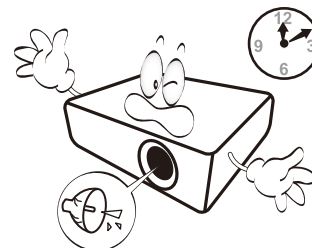

9. Never replace the lamp assembly or any electronic components unless the projector is unplugged.

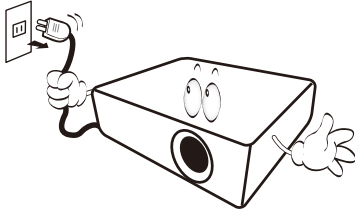

10. Do not place this product on an unstable cart, stand, or table. The product may fall, sustaining serious damage.

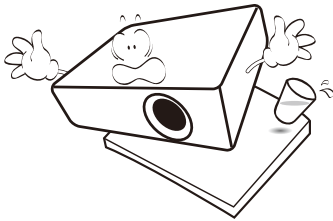

11. Do not attempt to disassemble this projector. There are dangerous high voltages inside which may cause death if you should come into contact with live parts. The only user serviceable part is the lamp which has its own removable cover.

Under no circumstances should you ever undo or remove any other covers. Refer servicing only to suitably qualified professional service personnel.

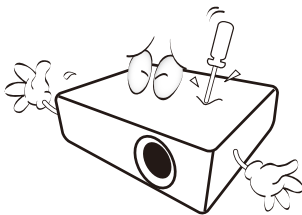

12. Do not block the ventilation holes.

- Do not place this projector on a blanket, bedding or any other soft surface.
- Do not cover this projector with a cloth or any other item.
- Do not place inflammables near the projector.

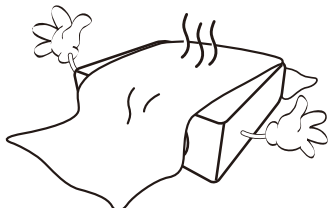

If the ventilation holes are seriously obstructed, overheating inside the projector may result in a fire.

13. Always place the projector on a level, horizontal surface during operation.

- Do not use if tilted at an angle of more than 10 degrees left to right, nor at angle of more than 15 degrees front to back. Using the projector when it is not fully horizontal may cause a malfunction of, or damage to, the lamp.

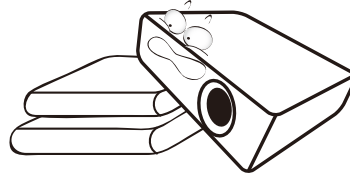

14. Do not stand the projector on end vertically. Doing so may cause the projector to fall over, causing injury or resulting in damage to the projector.

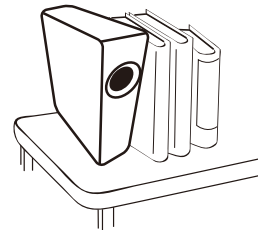

15. Do not step on the projector or place any objects upon it. Besides probable physical damage to the projector, doing so may result in accidents and possible injury.

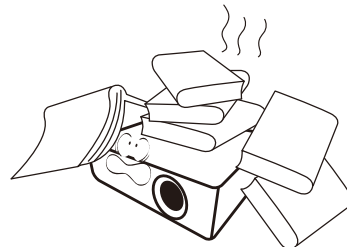

16. When the projector is under operation, you may sense some heated air and odor from its ventilation grill. It is a normal phenomenon and not a product defect.

17. Do not place liquids near or on the projector. Liquids spilled into the projector may cause it to fail. If the projector does become wet, disconnect it from the power supply's power outlet and call BenQ to have the projector serviced.

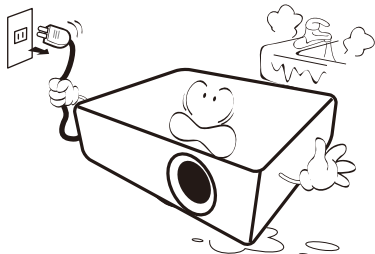

18. This product is capable of displaying inverted images for ceiling/wall mount installation.

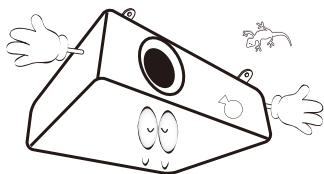

19. This apparatus must be earthed.

20. Do not place this projector in any of the following environments.

- Space that is poorly ventilated or confined. Allow at least 50 cm clearance from walls and free flow of air around the projector.
- Locations where temperatures may become excessively high, such as the inside of a car with all windows rolled up.
- Locations where excessive humidity, dust, or cigarette smoke may contaminate optical components, shorten the projector's life span and darken the image.

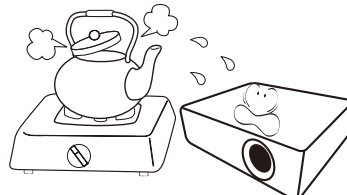

- Locations near fire alarms
- Locations with an ambient temperature above 40°C / 104°F
- Locations where the altitudes are higher than 3000 m (10000 feet).

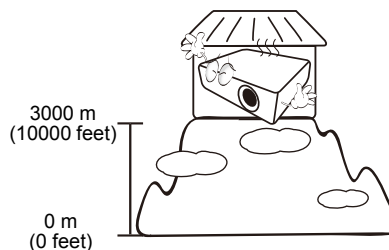

! Hg - Lamp contains mercury. Manage in accordance with local disposal laws. See www.lamprecycle.org.

! To avoid damaging the DLP chips, never aim a high-power laser beam into the projection lens.

Introduction

Shipping contents

Carefully unpack and verify that you have all of the items shown below. If any of these items are missing, please contact your place of purchase.

Standard accessories

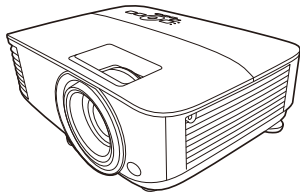

Projector

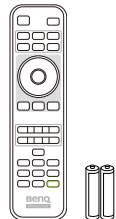

Remote control with batteries



Quick start guide



Warranty card*

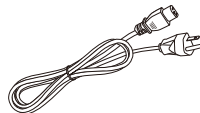

Power cord

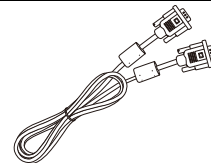

VGA cable

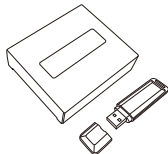

Wireless dongle



- The supplied accessories will be suitable for your region, and may differ from those illustrated.
- *The warranty card is only supplied in some specific regions. Please consult your dealer for detailed information.

Optional accessories

1. Spare lamp kit
2. 3D glasses

Replacing the remote control batteries

1. Press and open the battery cover, as illustrated.
2. Remove the old batteries (if applicable) and install two AAA batteries. Make sure that the positive and negative ends are positioned correctly, as illustrated.
3. Replace the battery cover until it clicks into place.

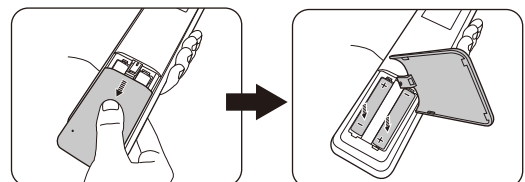



- Avoid leaving the remote control and batteries in an excessive heat or humid environment like the kitchen, bathroom, sauna, sunroom or in a closed car.
- Replace only with the same or equivalent type recommended by the battery manufacturer.
- Dispose of the used batteries according to the manufacturer's instructions and local environment regulations for your region.
- Never throw the batteries into a fire. There may be danger of an explosion.
- If the batteries are dead or if you will not be using the remote control for an extended period of time, remove the batteries to avoid damage to the remote control from possible battery leakage.

Installing the wireless dongle

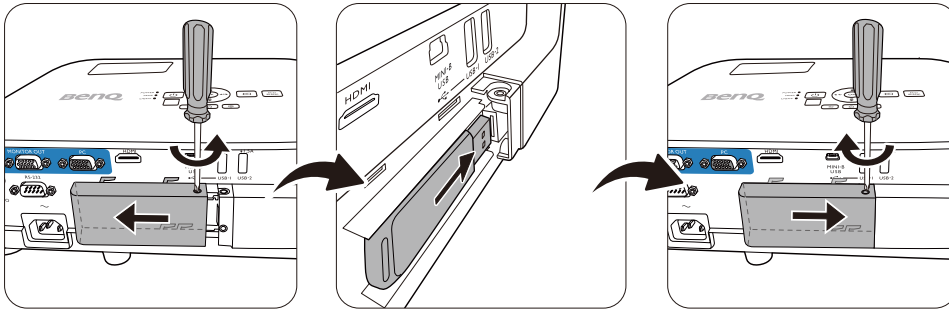

The projector only supports Wi-Fi and/or Bluetooth connections when the wireless dongle (WDR02U) is installed.

1. Loosen the screw that secures the I/O port cover to remove the I/O port cover.
2. Remove the cap from the provided wireless dongle and insert the dongle into the port
WIRELESS DONGLE.
3. Re-install the I/O port cover.

Projector exterior view

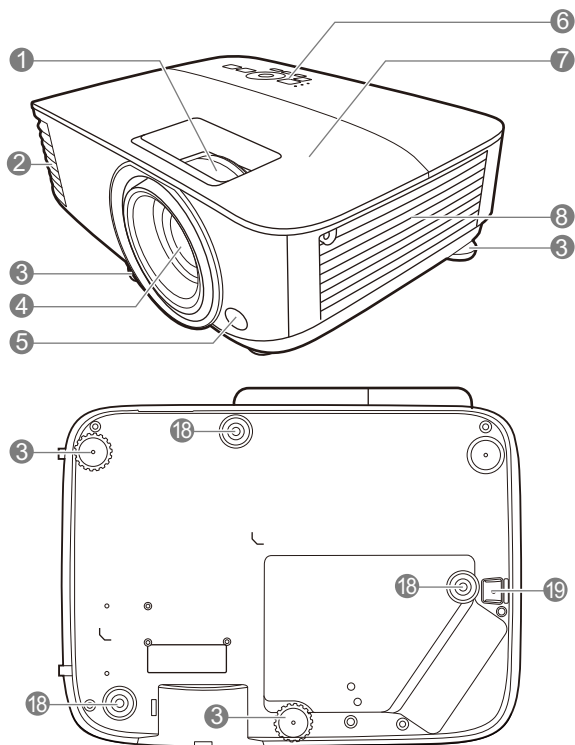

1. Focus ring and zoom ring
2. Vent (air exhaust)
3. Adjuster feet
4. Projection lens
5. IR remote sensor
6. External control panel
(See [Controls and functions on page 10.](#))
7. Lamp cover
8. Vent (air inlet)
9. Audio input jacks
Audio output jack
10. RGB (PC) signal output jack

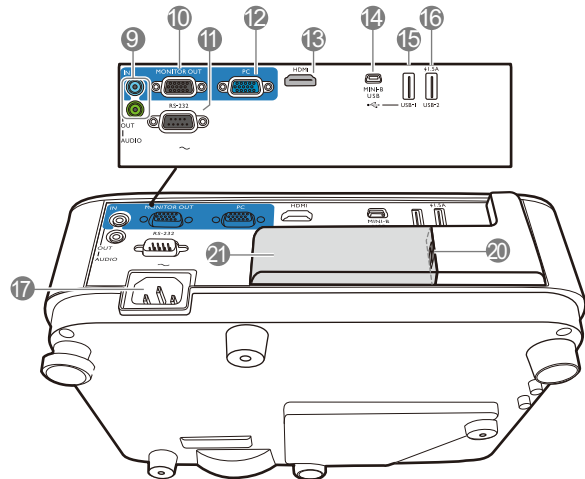

11. RS-232 control port
12. RGB (PC) signal input jacks
13. HDMI input port
14. USB Mini-B port
15. USB Type A port
16. USB Type A port
17. AC power jack
18. Wall mount holes
19. Security bar
20. USB Type A port (for wireless dongle)
21. Wireless dongle cover

Controls and functions

Projector & Remote control



- All the key presses described in this document are available on the remote control or projector.
- The remote control is without laser pointer in Japan.

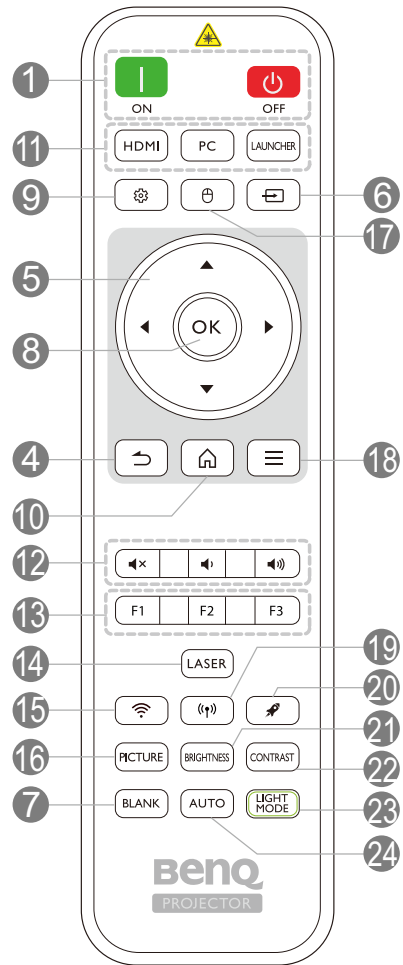
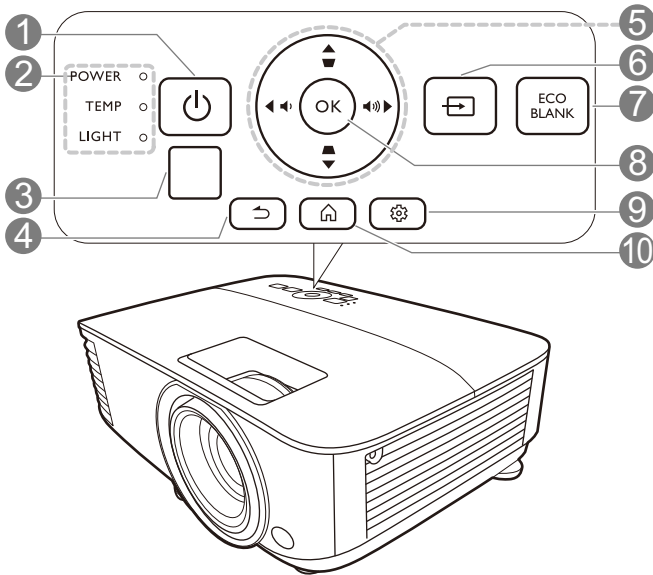

No.		When the input source is BenQ Launcher	When the input source is NOT BenQ Launcher
1.	POWER ON / Off	Toggles the projector between standby mode and on.	
2.	POWER indicator light/TEMPerature warning light/LAMP indicator light	(See Indicators on page 100.)	
3.	IR remote sensor		
4.	(BACK)	Returns to the previous menu, main settings menu or exit the app.	Goes back to previous OSD menu or exits menu settings.

No.		When the input source is BenQ Launcher	When the input source is NOT BenQ Launcher
5.	Arrow keys (▲, ▼, ◀, ▶)	Moves through the menu items or toggle through the available options.	When the On-Screen Display (OSD) menu is activated, these keys are used as directional arrows to select the desired menu items and to make adjustments.
	Keystone keys (△, ▽)	(Not available.)	Displays the keystone correction page.
	Volume keys (🔊/🔊)	(Not available.)	Decreases or increase the projector volume.
6.	📺 (SOURCE)	Displays the source selection bar.	
7.	ECO BLANK, BLANK	Used to hide the screen picture.  Do not block the projection lens from projecting as this could cause the blocking object to become heated and deformed or even cause a fire.	
8.	OK	Confirms the selected menu item.	Confirms the selected On-Screen Display (OSD) menu item.
9.	⚙️ (MENU)	Enters the Settings menu.	Turns on or off the projector's On-Screen Display (OSD) menu.
10.	🏠 (HOME)	Returns to the home screen.	(Not available.)
11.	Source selection buttons: HDMI, PC, LAUNCHER	Selects an input source for display.	
12.	🔊×	Toggles projector audio between on and off.	
	🔊)	Decreases the projector volume.	
	🔊))	Increase the projector volume.	
13.	Control buttons: F1, F2, F3	Customizes buttons, the default is iOS mobile projection settings (F1) / Android mobile projection settings (F2) / Laptop mobile projection settings (F3).	(Not available.)
14.	LASER	Emits visible laser pointer light for presentation purposes.	
15.	📶 (WiFi)	Enters the Internet menu in Settings .	(Not available.)
16.	PICTURE	Selects an available picture mode.	
17.	⊕ (Cursor)	Activates the cursor function.	(Not available.)
18.	☰ (Android menu)	Goes to the Settings menu. If app related settings can be called from within the app.	(Not available.)
19.	📶 (Hotspot)	Enters the Hotspot menu in Settings .	(Not available.)
20.	🗑️ (Clear memory)	Goes into one key speedup (one key empty) mode.	(Not available.)

No.		When the input source is BenQ Launcher	When the input source is NOT BenQ Launcher
21.	BRIGHTNESS	Adjusts brightness.	
22.	CONTRAST	Adjusts contrast.	
23.	LIGHT MODE	Displays the Light Mode menu for selecting a suitable lamp operating mode.	
24.	AUTO	(Not available.)	Automatically determines the best picture timings for the displayed image when PC signal (analog RGB) is selected.

Operating the LASER pointer

The Laser Pointer is a presentation aid for professionals. It emits red colored light when you press it. The laser beam is visible. It is necessary to press and hold **LASER** for continuous output.

The laser pointer is not a toy. Parents should be mindful of the dangers of laser energy and keep this remote control out of the reach of children.

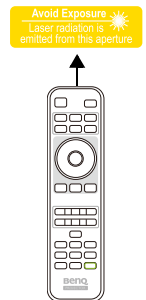

Do not look into the laser light window or shine the laser light beam on yourself or others. See the warning messages on the back of the remote control prior to using it.

Remote control effective range

The remote control must be held at an angle within 30 degrees perpendicular to the projector's IR remote control sensor(s) to function correctly. The distance between the remote control and the sensor(s) should not exceed 8 meters (~ 26 feet).

Make sure that there are no obstacles between the remote control and the IR sensor(s) on the projector that might obstruct the infra-red beam.

- Operating the projector from the front

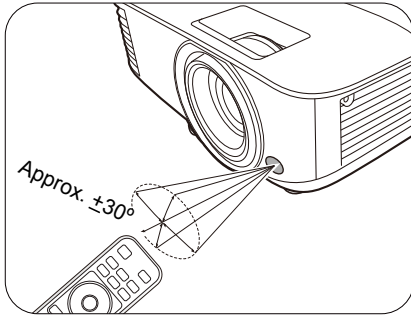

- Operating the projector from the top

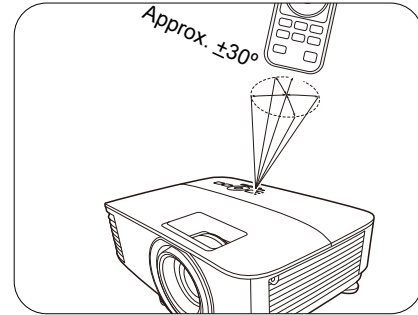

Positioning your projector

Choosing a location

Before choosing an installation location for your projector, take the following factors into consideration:

- Size and position of your screen
- Electrical outlet location
- Location and distance between the projector and the rest of your equipment

You can install your projector in the following ways.

1. Front Table

Select this location with the projector placed on the table in front of the screen. This is the most common way to position the projector for quick setup and portability.

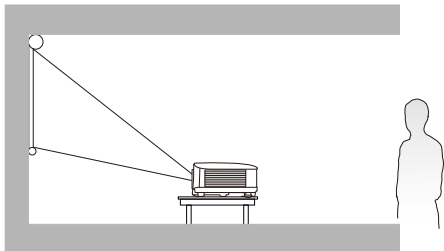

2. Rear Table

Select this location with the projector placed on the table behind the screen. Note that a special rear projection screen is required.

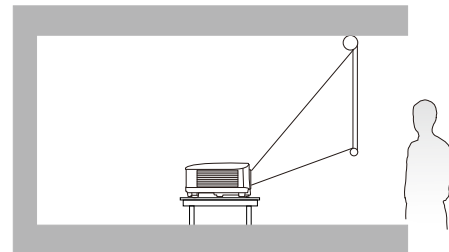

3. Front Ceiling

Select this location with the projector suspended upside-down in front of the screen. Purchase the BenQ Projector Ceiling/Wall Mount Kit from your dealer to mount your projector.

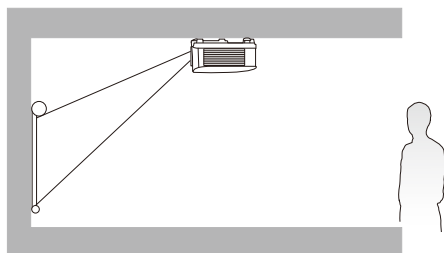

4. Rear Ceiling

Select this location with the projector suspended upside-down from behind the screen. Note that a special rear projection screen and the BenQ Projector Ceiling/Wall Mount Kit are required for this installation location.

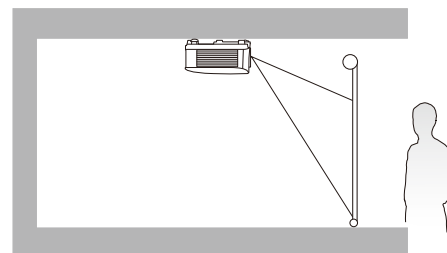

After turning on the projector, go to **Advanced Menu - Settings > Projector Installation > Projector Installation** and press ◀/▶ to select a setting.

Obtaining a preferred projected image size

The distance from the projector lens to the screen, the zoom setting (if available), and the video format each factors in the projected image size.

Projection dimensions

EX600

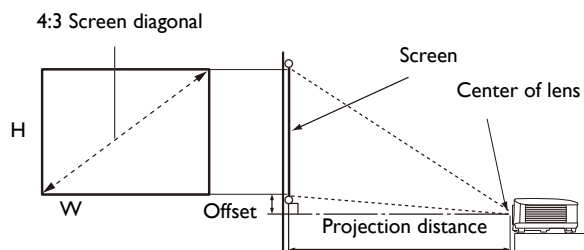

- The screen aspect ratio is 4:3 and the projected picture is in a 4:3 aspect ratio

Screen size				Projection distance (mm)			Offset (mm)
Diagonal		H (mm)	W (mm)	Min distance	Average	Max distance	
Inch	mm			(max. zoom)		(min. zoom)	
30	762	457	610	1195	1253	1311	45
40	1016	610	813	1593	1670	1748	61
50	1270	762	1016	1991	2088	2184	76
60	1524	914	1219	2390	2505	2621	91
70	1778	1067	1422	2788	2923	3058	107
80	2032	1219	1626	3186	3341	3495	122
90	2286	1372	1829	3584	3758	3932	137
100	2540	1524	2032	3983	4176	4369	152
110	2794	1676	2235	4381	4593	4806	168
120	3048	1829	2438	4779	5011	5243	183
130	3302	1981	2642	5178	5428	5679	198
140	3556	2134	2845	5576	5846	6116	213
150	3810	2286	3048	5974	6264	6553	229
160	4064	2438	3251	6372	6681	6990	244
170	4318	2591	3454	6771	7099	7427	259
180	4572	2743	3658	7169	7516	7864	274
190	4826	2896	3861	7567	7934	8301	290
200	5080	3048	4064	7965	8352	8738	305
250	6350	3810	5080	9957	10439	10922	381
300	7620	4572	6096	11948	12527	13106	457

For example, if you are using a 120-inch screen, the recommended projection distance is 5011 mm.

If your measured projection distance is 6200 mm, the closest match in the "Projection distance (mm)" column is 6264 mm. Looking across this row shows that a 150" (about 3.8 m) screen is required.



To optimize your projection quality, we suggest to do the projection within non-gray area.

All measurements are approximate and may vary from the actual sizes.

BenQ recommends that if you intend to permanently install the projector, you should physically test the projection size and distance using the actual projector in situ before you permanently install it, so as to make allowance for this projector's optical characteristics. This will help you determine the exact mounting position so that it best suits your installation location.

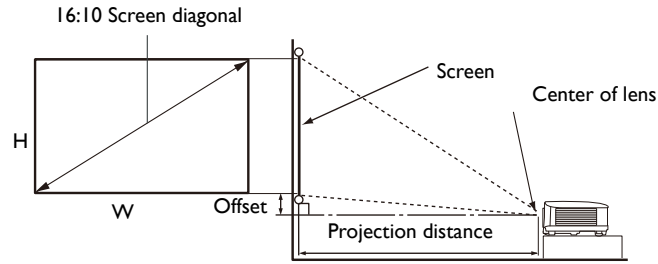

- The screen aspect ratio is 16:10 and the projected picture is in a 16:10 aspect ratio

Screen size				Projection distance (mm)			Offset (mm)
Diagonal		H (mm)	W (mm)	Min distance	Average	Max distance	
Inch	mm			(max. zoom)		(min. zoom)	
30	762	406	646	1002	1050	1098	0
40	1016	538	862	1335	1400	1465	0
50	1270	673	1077	1669	1750	1831	0
60	1524	808	1292	2003	2100	2197	0
70	1778	942	1508	2337	2450	2563	0
80	2032	1007	1723	2671	2800	2929	0
90	2286	1212	1939	3005	3150	3295	0
100	2540	1346	2154	3339	3500	3662	0
110	2794	1481	2369	3672	3850	4028	0
120	3048	1615	2585	4006	4200	4394	0
130	3302	1750	2800	4340	4550	4760	0
140	3556	1885	3015	4676	4900	5126	0
150	3810	2019	3231	5008	5250	5492	0
160	4064	2154	3446	5342	5600	5859	0
170	4318	2289	3662	5676	5950	6225	0
180	4572	2423	3877	6009	6300	6591	0
190	4826	2558	4092	6343	6650	6957	0
200	5080	2692	4308	6677	7000	7323	0
250	6350	3365	5385	8346	8750	9154	0
300	7620	4039	6462	10016	10500	10985	0

For example, if you are using a 120-inch screen, the recommended projection distance is 4200 mm.

If your measured projection distance is 5200 mm, the closest match in the "Projection distance (mm)" column is 5250 mm. Looking across this row shows that a 150" (about 3.8 m) screen is required.



To optimize your projection quality, we suggest to do the projection within non-gray area.

All measurements are approximate and may vary from the actual sizes.

BenQ recommends that if you intend to permanently install the projector, you should physically test the projection size and distance using the actual projector in situ before you permanently install it, so as to make allowance for this projector's optical characteristics. This will help you determine the exact mounting position so that it best suits your installation location.

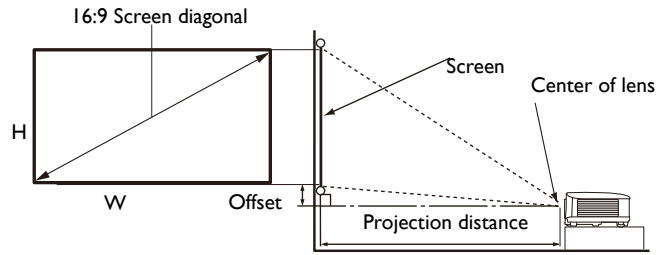

- The screen aspect ratio is 16:9 and the projected picture is in a 16:9 aspect ratio

Screen size				Projection distance (mm)			Offset (mm)
Diagonal		H (mm)	W (mm)	Min distance	Average	Max distance	
Inch	mm			(max. zoom)		(min. zoom)	
30	762	374	664	990	1039	1089	30
40	1016	498	886	1319	1386	1452	40
50	1270	623	1107	1649	1732	1815	50
60	1524	747	1328	1979	2079	2178	60
70	1778	872	1550	2309	2425	2541	70
80	2032	996	1771	2639	2772	2905	80
90	2286	1121	1992	2969	3118	3268	90
100	2540	1245	2214	3299	3465	3631	100
110	2794	1370	2435	3628	3811	3994	110
120	3048	1494	2657	3958	4158	4357	120
130	3302	1619	2878	4288	4504	4720	130
140	3556	1743	3099	4618	4850	5083	139
150	3810	1868	3321	4948	5197	5446	149
160	4064	1992	3542	5278	5543	5809	159
170	4318	2117	3763	5608	5890	6172	169
180	4572	2241	3985	5937	6236	6535	179
190	4826	2366	4206	6267	6583	6898	189
200	5080	2491	4428	6597	6929	7261	199
250	6350	3113	5535	8246	8661	9077	249
300	7620	3736	6641	9896	10394	10892	299

For example, if you are using a 120-inch screen, the recommended projection distance is 4158 mm.

If your measured projection distance is 5200 mm, the closest match in the "Projection distance (mm)" column is 5197 mm. Looking across this row shows that a 150" (about 3.8 m) screen is required.



To optimize your projection quality, we suggest to do the projection within non-gray area.

All measurements are approximate and may vary from the actual sizes.

BenQ recommends that if you intend to permanently install the projector, you should physically test the projection size and distance using the actual projector in situ before you permanently install it, so as to make allowance for this projector's optical characteristics. This will help you determine the exact mounting position so that it best suits your installation location.

Mounting the projector

If you intend to mount your projector, we strongly recommend that you use a proper fitting BenQ projector mounting kit and that you ensure it is securely and safely installed.

If you use a non-BenQ brand projector mounting kit, there is a safety risk that the projector may fall down due to an improper attachment through the use of the wrong gauge or length screws.

Before mounting the projector

- Purchase a BenQ projector mounting kit from the place you purchased your BenQ projector.
- BenQ recommends that you also purchase a separate Kensington lock compatible security cable and attach it securely to both the Kensington lock slot on the projector and the base of the mounting bracket. This will perform the secondary role of restraining the projector should its attachment to the mounting bracket become loose.
- Ask your dealer to install the projector for you. Installing the projector on your own may cause it to fall and result in injury.
- Take necessary procedures to prevent the projector from falling off such as during an earthquake.
- The warranty doesn't cover any product damage caused by mounting the projector with a non-BenQ brand projector mounting kit.
- Consider the surrounding temperature where the projector is ceiling/wall mounted. If a heater is used, the temperature around the ceiling/wall may be higher than expected.
- Read the user manual for the mounting kit about the range of torque. Tightening with torque exceeding the recommended range may cause damage to the projector and subsequently falling off.
- Make sure the power outlet is at an accessible height so that you can easily shut down the projector.

Ceiling/Wall mount installation diagram

Ceiling/Wall mount screw: M4
(Max L = 25 mm; Min L = 20 mm)

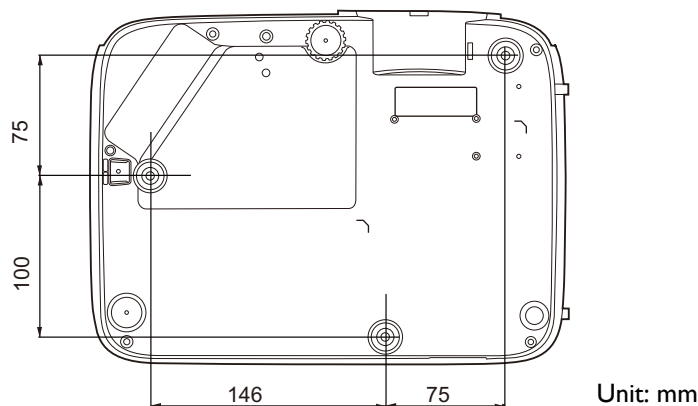

Adjusting the projected image

Adjusting the projection angle

If the projector is not placed on a flat surface or the screen and the projector are not perpendicular to each other, the projected image becomes trapezoidal. You can screw the adjuster feet to fine-tune the horizontal angle.

To retract the feet, screw the adjuster feet in a reverse direction.

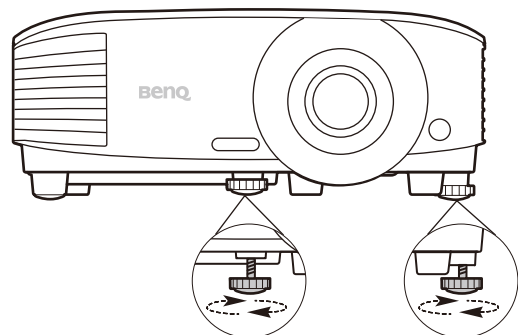

Do not look into the lens while the lamp is on. The strong light from the lamp may cause damage to your eyes.

Auto-adjusting the image

In some cases, you may need to optimize the picture quality. To do this, press **AUTO**. Within 3 seconds, the built-in Intelligent Auto Adjustment function will re-adjust the values of Frequency and Clock to provide the best picture quality.

The current source information will be displayed in the corner of the screen for 3 seconds.



This function is only available when PC signal (analog RGB) is selected.

Fine-tuning the image size and clarity

Adjust the projected image to the size that you need using the zoom ring.

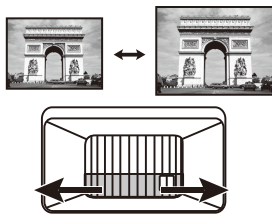

Sharpen the image by rotating the focus ring.

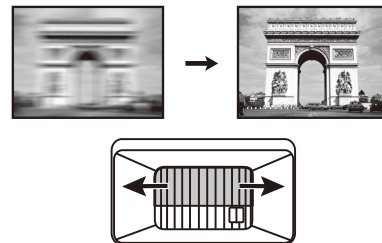

Correcting keystone

Keystoning refers to the situation where the projected image becomes a trapezoid due to angled projection.

To correct this, you will need to manually correct it following these steps.

1. Do one of the following steps to display the keystone correction page.
 - Press \triangle / ∇ on the projector or remote control.
 - Go to **Advanced Menu - Display > Keystone** and press **OK**.



2. After the **Keystone** correction page displays. Press \triangle to correct keystone at the top of the image. Press ∇ to correct keystone at the bottom of the image.

Connection

When connecting a signal source to the projector, be sure to:

1. Turn all equipment off before making any connections.
2. Use the correct signal cables for each source.
3. Ensure the cables are firmly inserted.

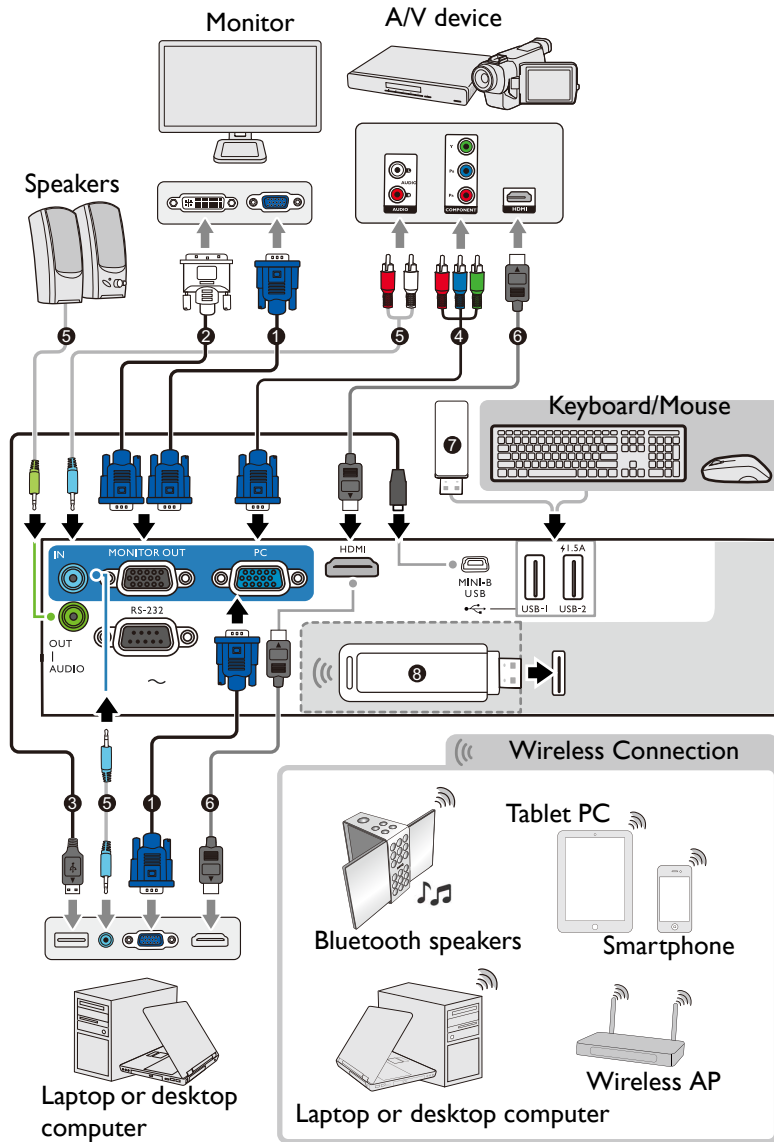

1	VGA cable
2	VGA to DVI-A cable
3	USB cable
4	Component Video to VGA (D-Sub) adapter cable
5	Audio cable
6	HDMI cable
7	USB flash drive
8	Wireless dongle (WDR02U)



- In the connections above, some cables may not be included with the projector (see [Shipping contents on page 7](#)). They are commercially available from electronics stores.
- The connection illustrations are for reference only. The rear connecting jacks available on the projector vary with each projector model.
- Many notebooks do not turn on their external video ports when connected to a projector. Usually a key combo like FN + function key with a monitor symbol turns the external display on/off. Press FN and the labeled function key simultaneously. Refer to your notebook's documentation to find your notebook's key combination.
- If the selected video image is not displayed after the projector is turned on and the correct video source has been selected, check that the video source device is turned on and operating correctly. Also check that the signal cables have been connected correctly.

You need only connect the projector to a video source device using just one of the connecting methods, however each provides a different level of video quality.

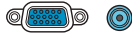
Terminal		Picture quality
HDMI		Best
Component Video (through RGB input)		Better

Connecting audio



The projector has built-in mono speaker(s) which are designed to provide basic audio functionality accompanying data presentations for business purposes only. They are not designed for, nor intended for stereo audio reproduction use as might be expected in home theater or home cinema applications. Any stereo audio input (if provided), is mixed into a common mono audio output through the projector speaker(s).

The built-in speaker(s) will be muted when the **AUDIO OUT** jack is connected.



- The projector is only capable of playing mixed mono audio, even if a stereo audio input is connected.
- If the selected video image is not displayed after the projector is turned on and the correct video source has been selected, check that the video source device is turned on and operating correctly. Also check that the signal cables have been connected correctly.





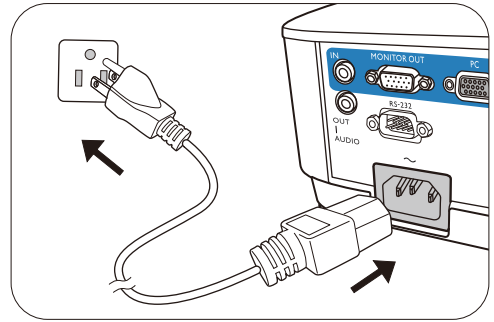

Starting up the projector

1. Plug the power cord. Turn on the power outlet switch (where fitted). The power indicator on the projector lights orange after power has been applied.
2. Press  on the projector or  on the remote control to start the projector. The power indicator flashes green and stays green when the projector is on. The start up procedure takes about 30 seconds. In the later stage of start up, a startup logo is projected.

(If necessary) Rotate the focus ring to adjust the image clearness.



- Please use the original accessories (e.g. power cord) to avoid possible dangers such as electric shock and fire.
- If the projector is still hot from previous activity, it will run the cooling fan for approximately 90 seconds before energizing the lamp.

3. If this is the first time you turn on the projector, the setup wizard appears to guide you through setting up the projector. If you have already done this, skip this process.
 - Use the arrow keys (, , , ) to move through the menu items.
 - Use **OK** to confirm the selected menu item.
 - Use the back button  to return to the previous menu.
 - Use the menu button  to skip a menu.

- The Setup Wizard screenshots are for reference only and may differ from the actual design.

Step 1:

Choosing a **Projector Position**.

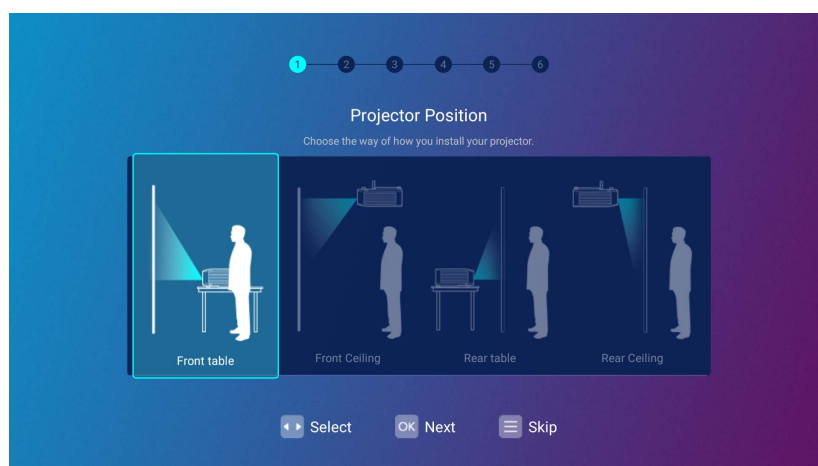

Step 2:
Choosing a **Language**.

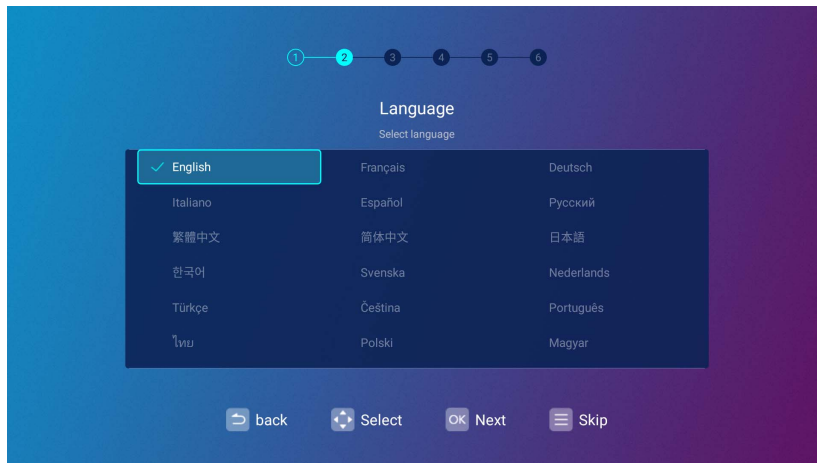

 Available languages may vary by the product supplied for your region and may be updated without prior notice.

Step 3:
Adjusting **Keystone**.

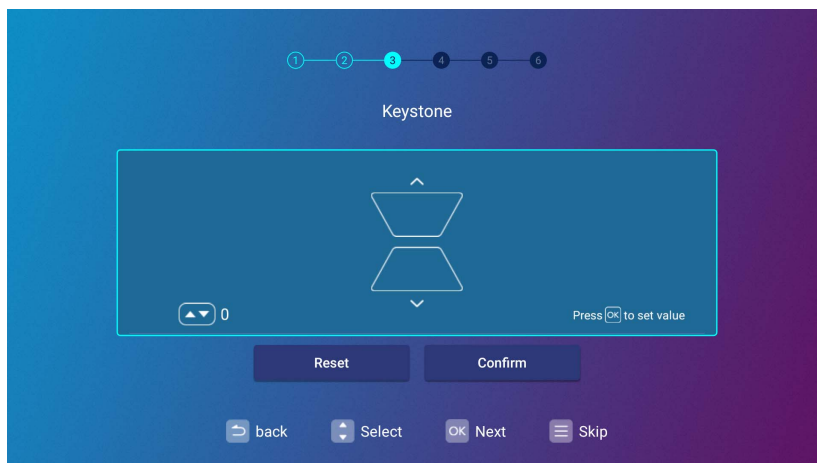

Step 4:
Configure the **Wireless Setting** by selecting a wireless network and entering the password.

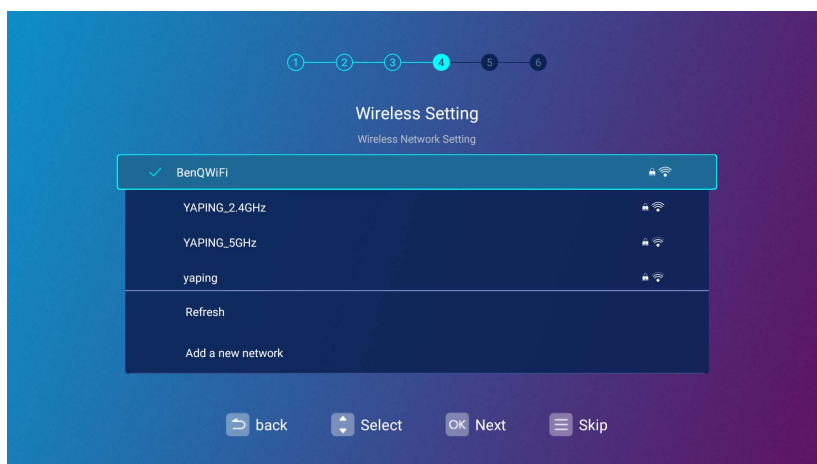

Step 5:
Specify **Time Zone**.

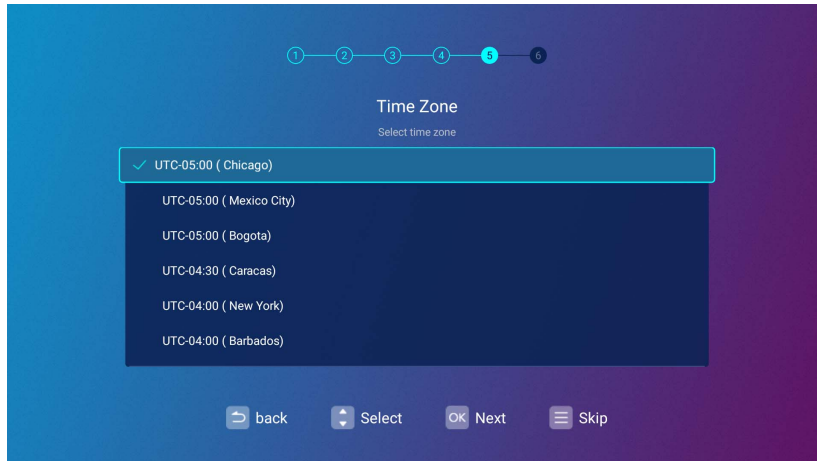

Step 6:
Read the **Privacy Announcement** and press **OK** to agree with the statement.

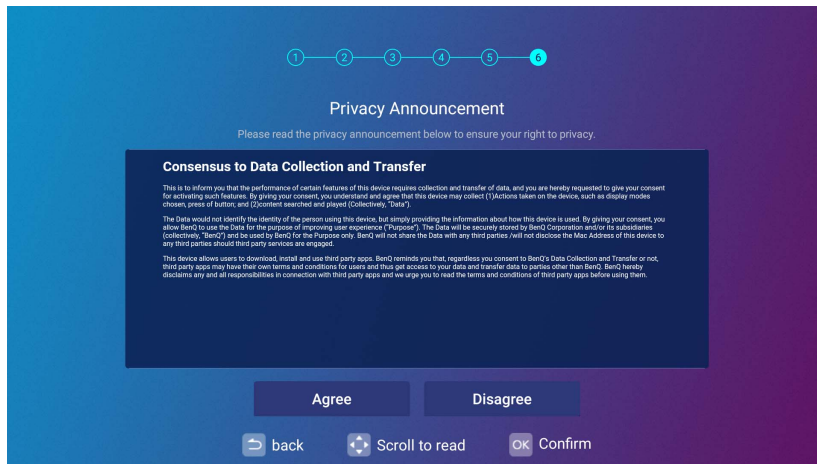

 If at a future time you want to remove your consent to the privacy agreement, you may do so in the **General > About > Privacy Announcement** menu of the **BenQ Launcher Settings** menu. See **About on page 135** for more information.

Once you've completed the steps shown above; the projector will ask whether you want to enable the AMS function.

If you are not prompted to enable AMS function, you are recommended to upgrade the firmware to optimize the user experience. See [System Update on page 144](#) for details. If you prefer not to upgrade the firmware, refer to [Appendix: Operation \(under Launcher source\) for firmware version before v01.00.19.00 on page 107](#) for operations.

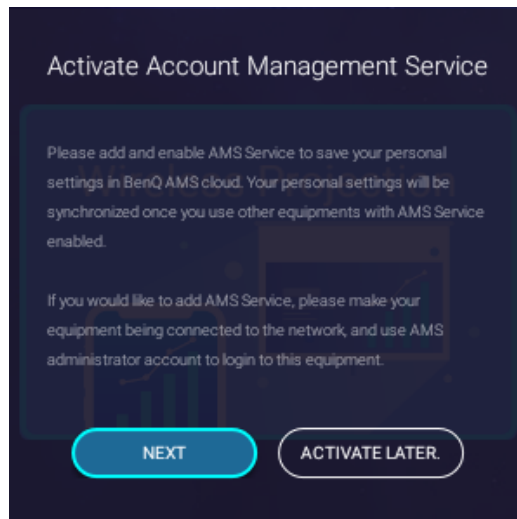

Now you have three ways to work with this projector. Different operations are required depending on your needs.

Scenarios	Available functions	Operations
Access BenQ Launcher with AMS account	<p>The complete BenQ Launcher functions:</p> <ul style="list-style-type: none"> • AMS service (page 27) • Wi-Fi connection (page 41) • Bluetooth connection (page 55) • USB storage connection (page 53) • Apps (page 58) • HID connectivity (e.g., mouse and keyboard connection) 	<p>If you have already successfully registered an administrator account on the AMS website, select NEXT in the pop-up window. See Binding an AMS administrator account to your projector on page 28, for further instructions.</p>
Access BenQ Launcher without AMS service	<p>All BenQ Launcher functions except AMS service.</p>	<p>If you do not yet have an AMS administrator account, select ACTIVATE LATER in the pop-up window and press OK. The AMS service will be disabled on the projector until you manually enable it via the Settings menu. See Enabling AMS on page 27 for more information on manually enabling the AMS service.</p>
Traditional projector	<p>Wired projection only, without network and HID connectivities</p>	<p>Press the HDMI or PC on the remote control or  (SOURCE) and select HDMI or PC/YPbPr.</p>



For more information on how to register for an AMS administrator account, see [Before you get started on page 26](#).

Operation (under Launcher source)

Before you get started

One of the key features for this projector is its use of the Account Management System (AMS) service which allows you to create and manage individual login accounts for the projector. By using the AMS service you will be able to:

- Customize the projector's workspace for each login
- Access files stored in cloud storage accounts (such as Google Drive, Dropbox, and others) directly from the projector
- Manage authorization for each login, including limiting access to various projector's functions.

In order to use the AMS service it is highly recommended that you first register for an AMS administrator account before you begin the initial start-up process for the projector. To register for an AMS account open the BenQ Service website (<https://service-portal.benq.com/login>) using a Chrome or Firefox browser, click the **Register (Admins only)** link, and proceed with the registration process.

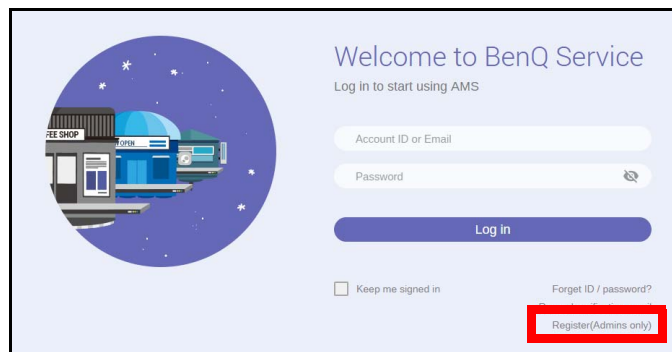

For a full description of the features of the AMS service, including instructions on how to setup and manage accounts, refer to the **AMS User Manual** which you can download at the following URL: <https://www.benq.com/en-us/business/index.html> > your Projector Model > **Downloads** > **User Manual**.



The images in this document are for reference only. The user interface may be subject to change without prior notice.

The AMS Service

As mentioned previously the AMS service is a key feature of this projector that allows you to customize the projector’s workspace, access files stored in cloud storage accounts directly from the projector, and manage access to various projector’s functions based on a user’s login.

For a full description of the features of the AMS service, including instructions on how to setup and manage accounts, refer to the **AMS User Manual** which you can download at the following URL: <https://www.benq.com/en-us/business/index.html> > your Projector Model > **Downloads** > **User Manual**.

Enabling AMS

If the AMS service was not enabled in the setup wizard procedure during your initial startup. You will have to manually enable AMS. To manually enable AMS:

1. Ensure that you have already created an AMS administrator account. See [Before you get started on page 26](#) for more information on registering for an AMS administrator account.
2. Choose one of the following methods:
 - Select **AMS Service** on the **BenQ Launcher** home screen and press **OK**.
 - Select the **Settings** menu button on the **BenQ Launcher** home screen, and press **OK**. Then select **AMS Service** in the **Preference** section of the **Settings** menu and press **OK**.

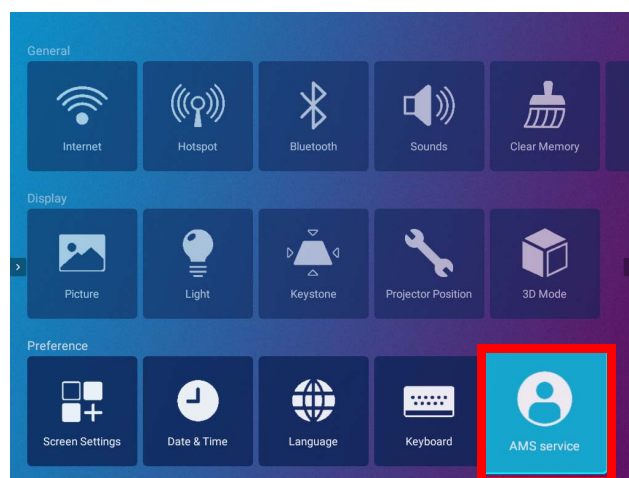
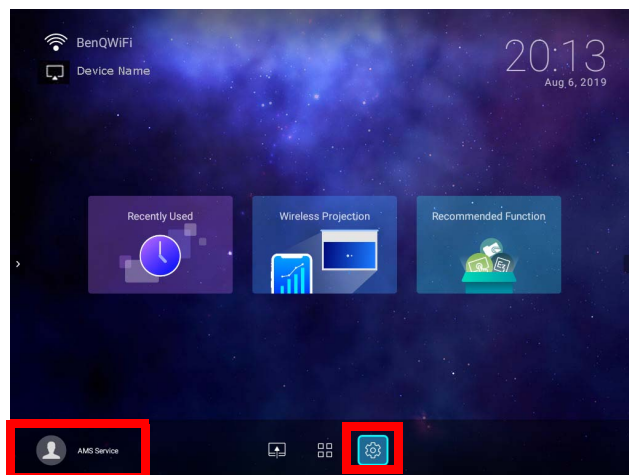

3. In the **AMS Service** screen press **OK** so that the **AMS Service** switch is set to **On**.

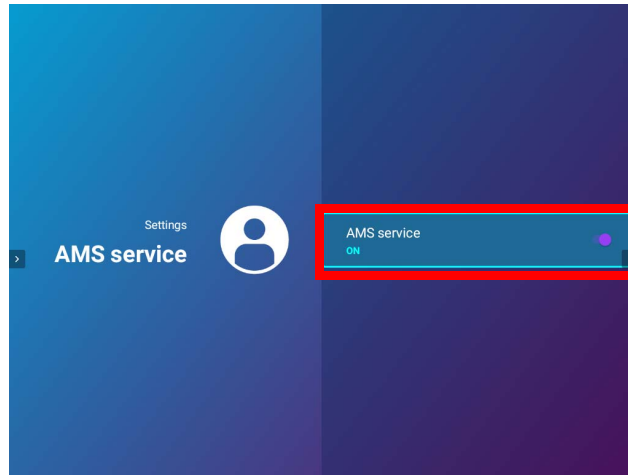

Once the AMS function is enabled on your projector you must bind your AMS administrator account to the projector before you can utilize the AMS service.

Binding an AMS administrator account to your projector

Once you have enabled the AMS function the next step is to bind an AMS administrator account to your projector so as to designate a specific administrator for your projector (i.e. to ensure that only one administrator is authorized to manage the projector).



Before binding an administrator account to your projector, you must first ensure that the following conditions are met for your projector:

- You have successfully registered for an AMS administrator account. See [Before you get started on page 26](#) for more information on registering for an AMS administrator account.
- Your projector is connected to a wireless network with Internet access. See [Connecting the projector to a wireless network on page 41](#) for more information on connecting to a wireless network.
- **AMS Service** is enabled for your projector. See [Enabling AMS on page 27](#) for more information on enabling **AMS Service**.

After enabling the AMS function a **Log in as administrator** window will pop-up. To bind an administrator account to your projector:

Enter the **Username** and **Password** for your AMS administrator account in the **Log in as administrator** window, select **Login** and press **OK**. If you do not want to bind an account to the projector select **Cancel** and press **OK**.

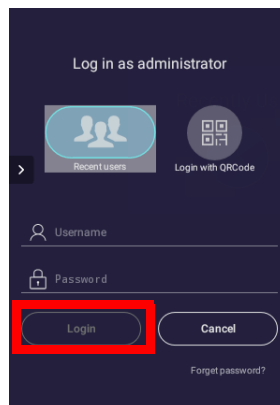

Once you have submitted your administrator account's login information a message will appear indicating that you have successfully bound your administrator account to the projector. To double check whether the binding process is successful you can check the **Device information** menu in the AMS service account menu, see [The Account Menu on page 31](#) for more information.

AMS Accounts

Once your AMS administrator account has been successfully bound to the projector, users can login to an account before they use the projector and depending on the type of account they are using and the settings configured for the account, they will be able to use customized interfaces and designated features, as well as access personal cloud storage.

The following is a list of the types of logins available for the projector:

Administrator – This account must be created/registered via the AMS website and includes full access to the projector’s features and **Settings** menus.

User – This account must be created by the administrator via the AMS website and is allowed access to the projector’s features and **Settings** menus based on default authorizations and configurations set by the administrator. Users can customize the interface they view on the projector, such as configuring the app shortcuts or linking to personal cloud accounts, by logging into the AMS website and adjusting their preferences.

Guest – This is the default setting when no account has been logged into the projector. It features limited access to the projector’s features and **Settings** menus.

Logging in



Before logging in on your projector, you must first ensure that the following conditions are met for your projector:

- Your projector is connected to a wireless network with Internet access. See [Connecting the projector to a wireless network on page 41](#) for more information on connecting to a wireless network.
- **AMS Service** is enabled for your projector. See [Enabling AMS on page 27](#) for more information on enabling **AMS Service**.

To log in to the projector using an AMS account, select **Login** on the **BenQ Launcher** home screen and press **OK**.

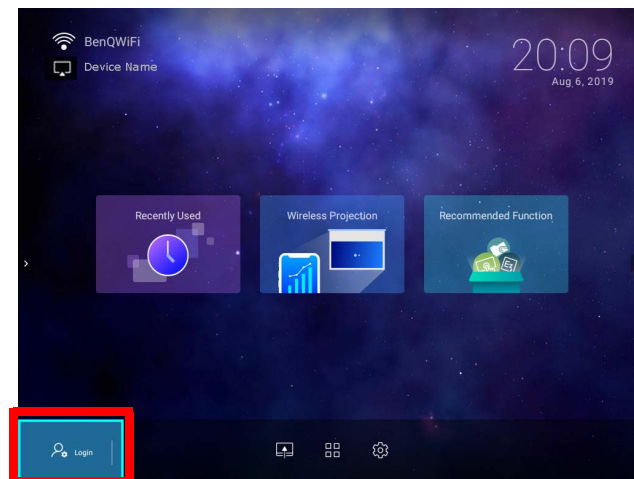

Use either one of the following methods to complete the log in process:

- Enter the **Username** and **Password** for your AMS account in the **Login** window, and then select **Login** and press **OK**.

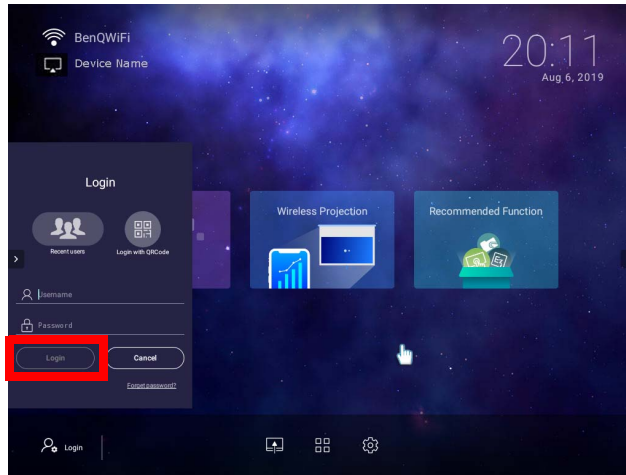

You can select **Recent users** in the **Login** window and press **OK** to select a **Username** from a list of a recently used logins.

- Select **Login with QR Code** in the **Login** window and press **OK**. Scan the QR code that appears with your mobile device and open the link provided to log in via your mobile device.

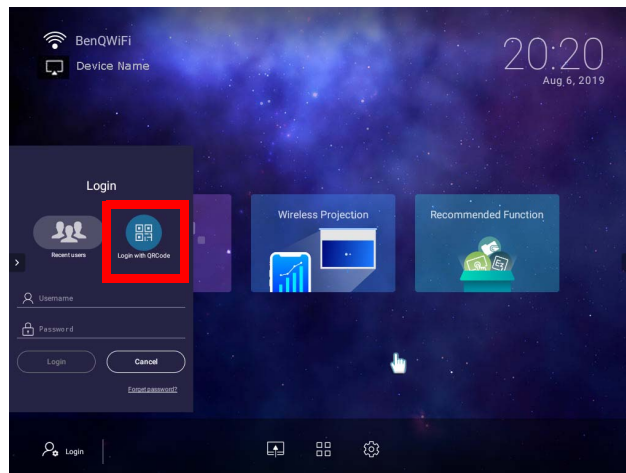

If your projector is not connected to a wireless network with Internet access, only accounts that are listed in the **Available offline accounts** list of the administrator's account menu will be able to login to AMS. See [The Account Menu on page 31](#), for more information on the account menu.,

The Account Menu

When you are logged into the projector using an AMS account, the bottom-left corner of the **BenQ Launcher** home screen will identify the account that is currently logged in. Select the icon for the account name and press **OK** to open a menu of account related options.

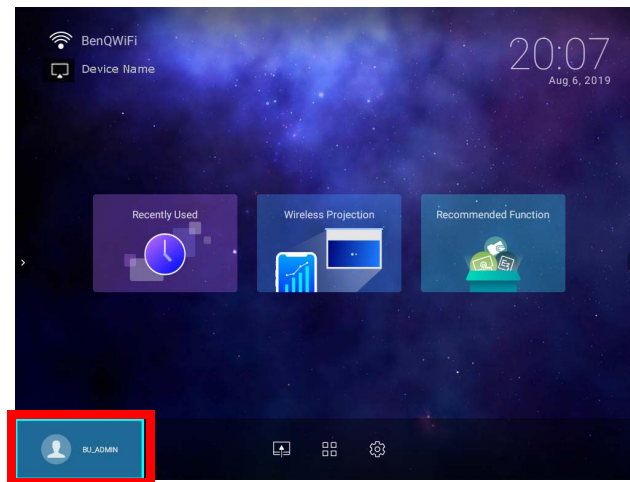

The account menu features the following options:

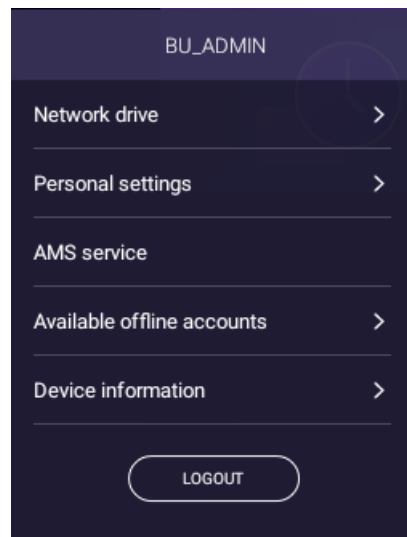

Item	Description
Network drive	Opens your personal files via the AMS Files app, where you can access files stored on the cloud storage account that you've linked to your AMS account or on the internal storage. See AMS Files on page 58 for more information of the features of the AMS Files app.
Personal settings	Allows you to set the amount of idle time before the projector automatically logs you out. The options include 10 minutes, 20 minutes, 30 minutes, 40 minutes, 50 minutes, and 60 minutes.
AMS service	Allows you to disable AMS Service .  This option is not available for User accounts.
Available offline accounts	Lists the accounts that are available to login when the projector does not have access to the Internet.

Item	Description
Device information	Lists the information for the administrator account that is bound to the projector, including an option to UNBIND the account from your projector.  The UNBIND option only appears for the administrator.
LOGOUT	Logs your account out of the projector.

Unbinding an administrator account from the projector

In instances when you want to switch an administrator account for the projector, you will have to first unbind the current administrator account from the projector.

To unbind an administrator account:

1. Log in on the projector using the **Username** and **Password** for the current administrator. See [Logging in on page 29](#) for more information on how to log in on the projector.
2. Enter the account menu. See [The Account Menu on page 31](#) for more information on the account menu.
3. Select **Device information** in the account menu and press **OK**.

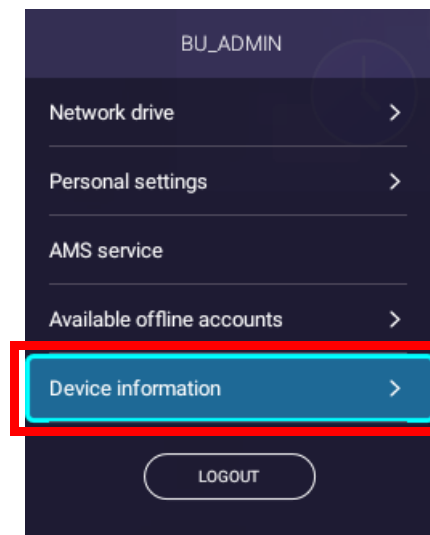

4. Select **UNBIND** and press **OK**.

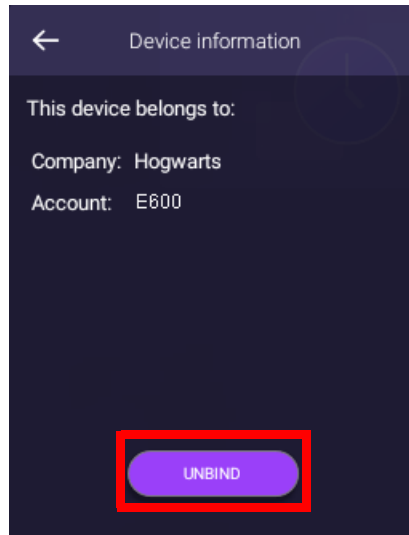

Checking for system update

It is suggested that users regularly update their projector with the latest version of the firmware to optimize the user experience. The projector uses Over-the-Air (OTA) updates to install the update file wirelessly.

When a new version is available on the BenQ OTA server, a message will pop up once the projector is connected to a wireless network. You can find the availability of a new firmware version from the notification icon on the lower-part of the **BenQ Launcher** home screen.

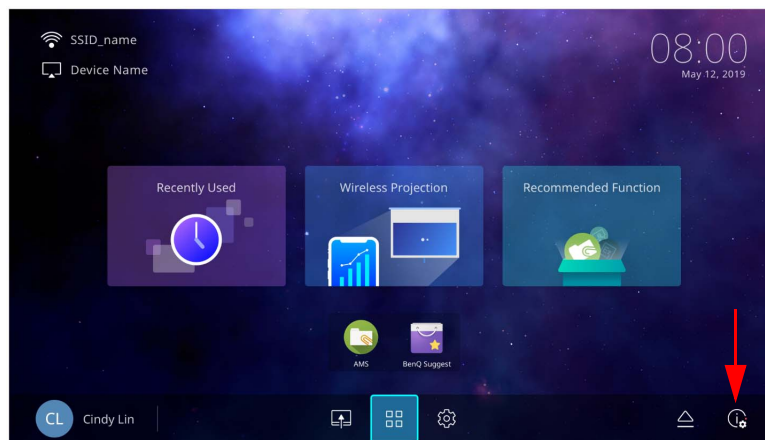

Follow the steps below to begin updating the firmware:

1. Select **DOWNLOAD** to download the update file.

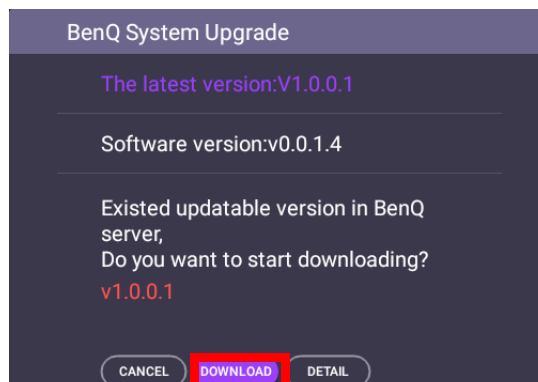

2. Once the download is completed, the projector will restart automatically. Do not turn off or unplug the projector before the projector is finished updating and **BenQ Launcher** reappears on the screen.

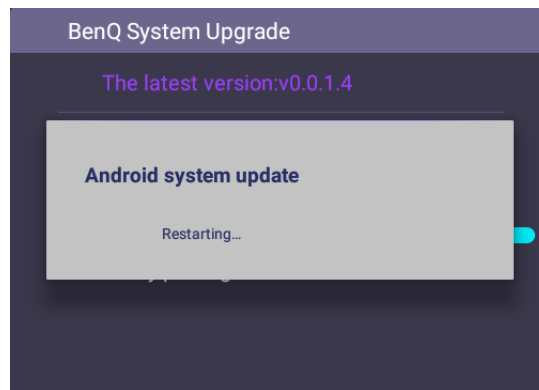



BenQ Launcher

BenQ Launcher is the projector’s operating system that allows you to wirelessly cast your device’s screen, play files, run apps, as well as adjust projector settings.

 Use the buttons on the projector, the remote control, or connect a USB mouse to the projector’s **USB-1** or **USB-2** ports to navigate **BenQ Launcher** and operate its functions.

The BenQ Launcher home screen

Upon initial start up or when **BenQ Launcher** is selected in the input source menu, the projector will display **BenQ Launcher**. If the projector is projecting from an input source (e.g. **HDMI** or **PC/YPbPr**), you can return to **BenQ Launcher** mode by pressing the source button  or the **LAUNCHER** button on the remote control and then selecting **BenQ Launcher** in the input source menu.

 When the **Auto Source** function is enabled in the **Advanced > Settings** menu of the projector’s OSD menu, the projector will display the **BenQ Launcher** home screen by default every time it is powered on. If the **Auto Source** function is disabled, the projector will detect if a signal is available from the input source that was last used and switch to that input source if it is available, if a signal is not available or the projector was set to **BenQ Launcher** during the previous session, the projector will enter the **BenQ Launcher** home screen. See [Settings on page 90](#).



 Actual screen may vary based on your **BenQ Launcher** firmware version.

The **BenQ Launcher** home screen features six main components:

No.	Component	Description
1	Status Bar	Icons that display the time, Bluetooth, wireless status, and device name.
2	Main Menu	Shortcuts to recently used apps/documents, instructions on how to project wirelessly, and recommended features/functions. See Using the Main Menu on page 37 for more information regarding the Main Menu.
3	Sidebar	A menu of quick navigation buttons. See Using the sidebar on page 40 for more information regarding the sidebar buttons.

No.	Component	Description
4	App Shortcuts	<p>A customizable list of shortcuts for installed apps. See Using the App Shortcuts on page 38 for more information regarding the app shortcuts</p>  <p>No app shortcuts appear on the default home screen. To add app shortcuts to the home screen, use either the Screen Settings sub-menu in the Settings menu or the AMS website. See Screen Settings on page 72 or refer to the AMS User Manual which you can download at the following URL: https://www.benq.com/en-us/business/index.html > your Projector Model > Downloads > User Manual.</p>
5	AMS Service Menu	Allows you to login to the projector using your AMS Service account. See The AMS Service on page 27 for more information regarding the AMS Service.
6	Toolbar	Buttons for the input source, all apps, and Settings menu. See Using the Toolbar on page 39 for more information regarding the toolbar.



Press the down button ▼ to access the **Source** menu, App shortcuts, and **Settings** menus.

Navigating the **BenQ Launcher** home screen

1. From the **BenQ Launcher** home screen, press ▲/▼/◀/▶ to select the desired function and press **OK**.
2. Follow on-screen instructions for further operations.

Inputting text

Various menus within **BenQ Launcher** may require that you input text. You may either connect a keyboard to the **USB-1** or **USB-2** port at the rear of the projector or follow the steps below:

1. Select the text field where you want to input text.
2. Press **OK** and a full alphanumeric keyboard will appear on screen.
3. Press ▲/▼/◀/▶ to navigate the keyboard, and press **OK** to select the letter/key/symbol you want to enter into the text field.
4. Press the back button ↶ at anytime to exit out of the keyboard.



Actual keyboard types may vary based on your language preference setting. See [Keyboard on page 74](#) for more information.

Using the Main Menu

The Main Menu includes buttons to access the following functions:

- **Recently Used** - A menu of recently opened apps or documents. See [Recently Used on page 68](#) for more details on the **Recently Used** menu.
- **Wireless Projection** - Instructions on projecting from your an iOS, Android, or Windows device. See [Wireless Connections on page 41](#) for more details on projecting wirelessly.
- **Recommended Function** - Introductions to recommended functions for your projector. See [Recommended Function on page 37](#) for more details.

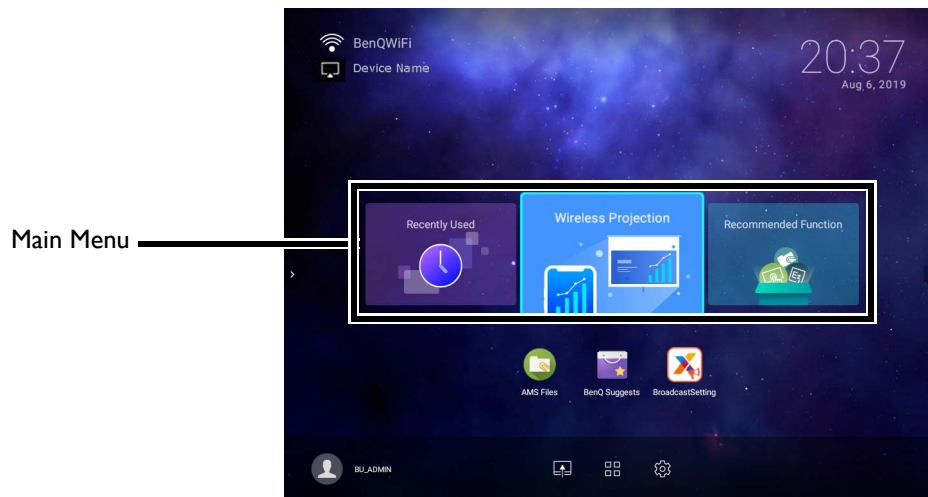

Recommended Function

The **Recommended Function** feature is a shortcut to recommended apps for your projector.

Using the App Shortcuts

The App Shortcuts menu is a list of shortcuts for installed apps which can be customized by the user via either the **Screen Settings** sub-menu in the **Settings** menu or the AMS service website for AMS login accounts. See [Screen Settings on page 72](#) for details on customizing the app shortcuts menu via the **Screen Settings** sub-menu, or refer to the **AMS User Manual** which you can download at the following URL: <https://www.benq.com/en-us/business/index.html> > your Projector Model > **Downloads > User Manual**.



- If **AMS Service** is disabled on the projector, the list of app shortcuts can only be customized via the **Screen Settings** sub-menu, and the selected shortcuts will appear on the home screen at all times.
- If **AMS Service** is enabled on the projector, only the list of app shortcuts that are customized for the AMS account that is logged in will appear.

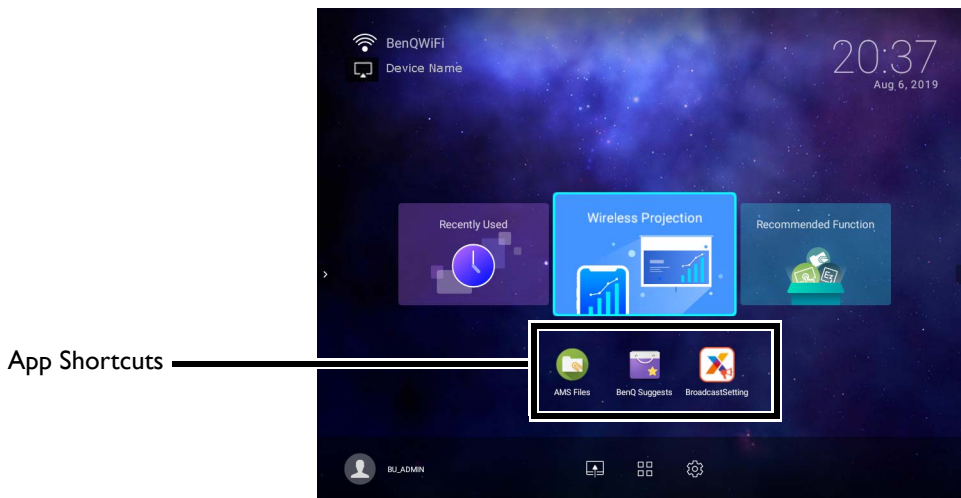



To access all the apps installed on the projector, see [All Apps on page 68](#). For details on how to re-order the shortcuts see [Screen Settings on page 72](#).

Using the Toolbar

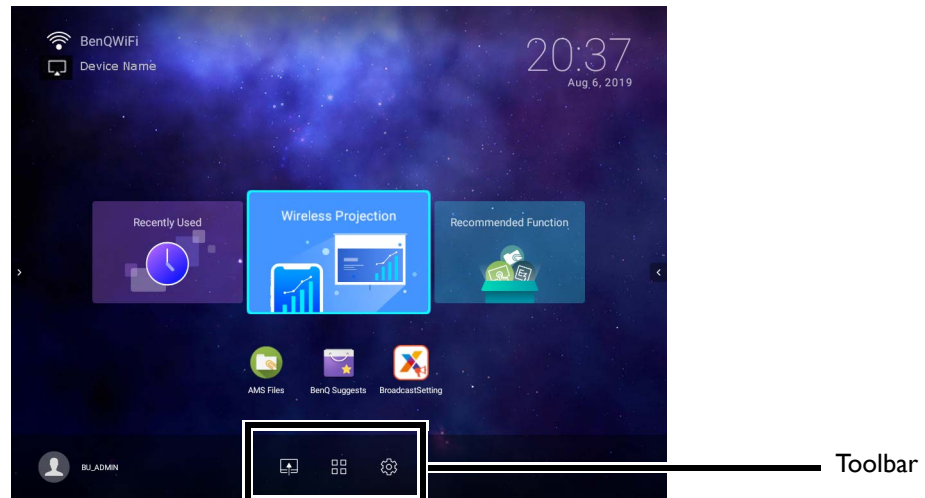
The tool bar features buttons to access the input source menu, the all apps menu, and the **Settings** menu.



Button	Description
	Select to open the input source menu.
	Select to open the all apps menu. See All Apps on page 68 for more details on the all apps menu.
	Select to open the Settings menu. See About the Settings menu on page 63 for more information on the Settings menus

The Input Source menu

The input source displays the input source options: **File Manager** (for storage devices connected to the **USB-1** or **USB-2** port), **HDMI**, or **PC/YPbPr**. Select the desired input source and press **OK** to begin viewing video from that source. See [Connection on page 20](#) for more information on connecting input sources.

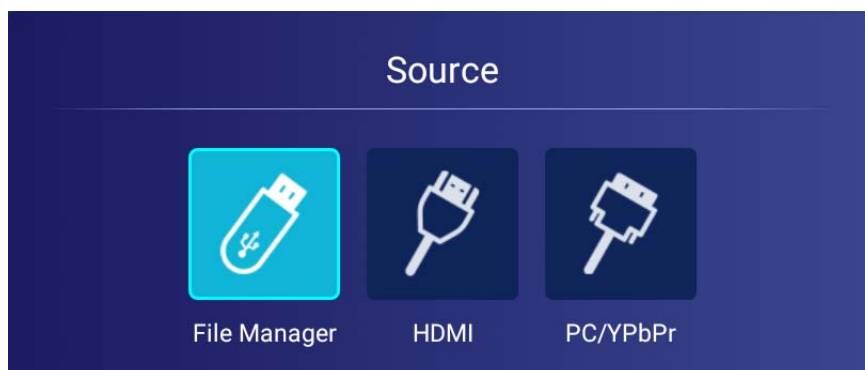



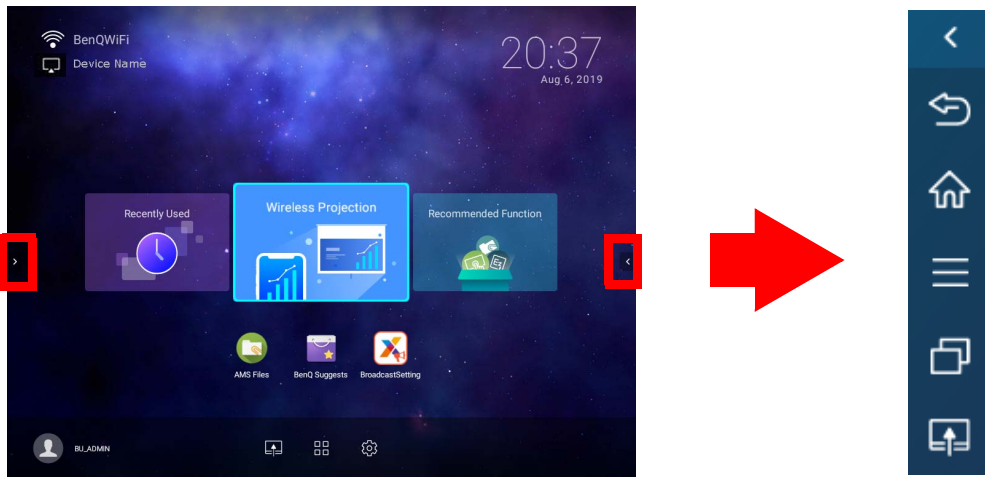

Using the sidebar

For situations where the projector is out of the reach of the user (for example, when the projector is mounted on the ceiling) and as a result the buttons on the projector are not accessible, **BenQ Launcher** features sidebars on both the left and right side of the screen that can be called out at anytime to access a set of virtual buttons. To call out the sidebar on a screen, click the arrow buttons on the left or right side of the screen.

 An HID-protocol device (e.g. a mouse) must be connected to the projector to be able to use the side bar.



The following buttons are included in the sidebar:

Icon	Description
	Select to go back to the previous screen.
	Select to return to the BenQ Launcher home screen.
	Select to open Android-based context menus.
	Select to edit the Recently Used apps menu.
	Select to open the input source menu

Switching to **BenQ Launcher** from an input source

When **HDMI** or **PC/YPbPr** is selected in the source menu, the projector will exit the **BenQ Launcher** interface to project video from the input source (e.g. a Blu-Ray/DVD player, set-top box, or PC). The projector will remain outside of the **BenQ Launcher** interface as long as the **HDMI** or **PC/YPbPr** input source is selected or (depending on **Auto Source** settings) until the projector is powered off and back on again.

As a result, anytime the user wants to wirelessly cast their device's screen, view media files stored on a flash drive, or run apps, they must return to the **BenQ Launcher** interface. To return to **BenQ Launcher**:

1. Press the source button  or the **LAUNCHER** button on the remote control.
2. Select **BenQ Launcher** in the source menu.

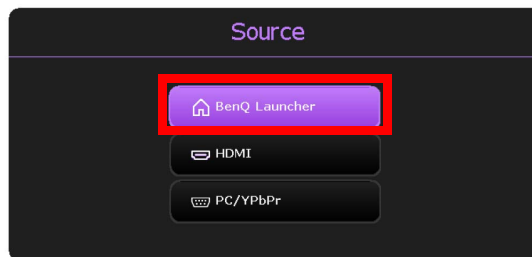

When the **Auto Source** function is enabled in the **Advanced > Settings** menu of the projector's OSD menu, the projector will display the **BenQ Launcher** home screen by default once it is powered on. If the **Auto Source** function is disabled, the projector will detect if a signal is available from the input source that was last used and switch to that input source if it is available, if a signal is not available or the projector was set to **BenQ Launcher** during the previous session, the projector will enter the **BenQ Launcher** home screen. See [Settings on page 90](#).

Wireless Connections

Connecting the projector to a wireless network

Before you can project wirelessly via the projector, you must first connect the projector to a wireless network. To connect your projector to a wireless network, or to switch wireless networks:



If you have already connected the projector to a wireless network during the setup wizard you may skip the steps in this section.

1. Install the provided wireless dongle into the wireless dongle port (see [Installing the wireless dongle on page 8](#)).
2. Power on the projector (see [Starting up the projector on page 22](#)).

3. On the home screen of the **BenQ Launcher** interface select the **Settings** button and press **OK**.

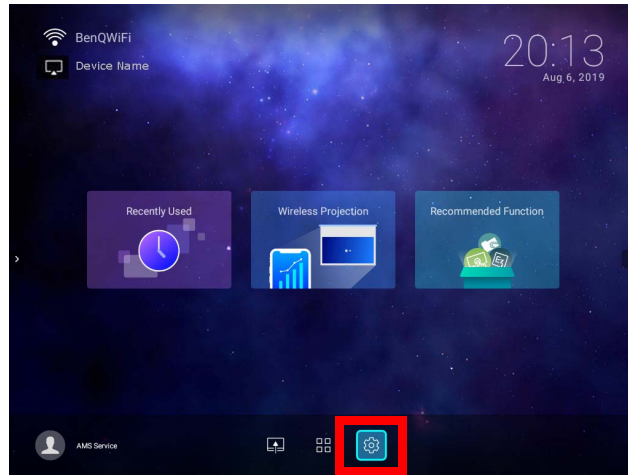

4. Select **Internet** in the **General** section of the **Settings** menu and then press **OK**.

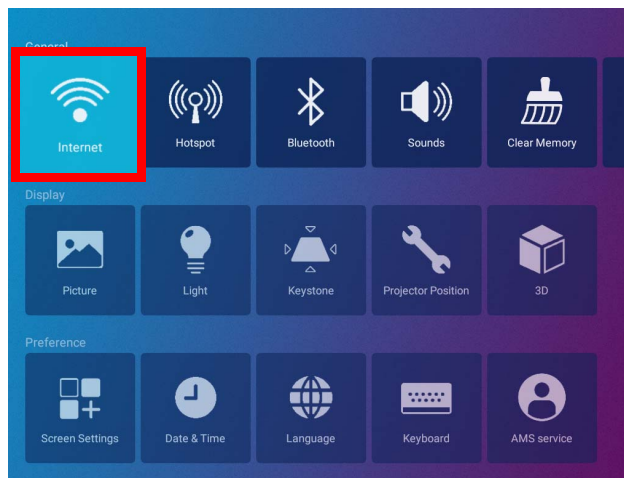

5. Select **Wireless Network Settings** and press **OK** to enable.

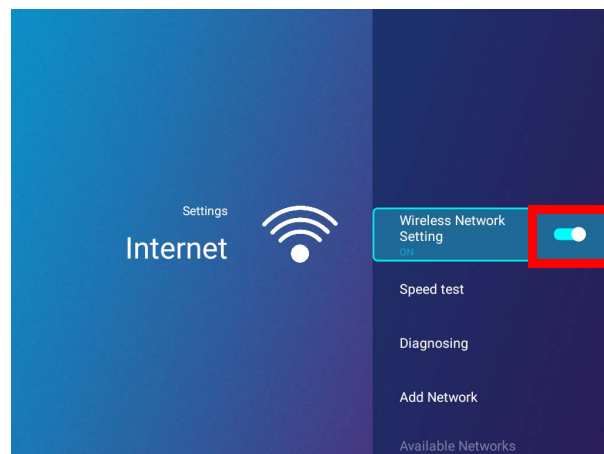

6. Select the SSID for the wireless AP you want to connect to and press **OK**.

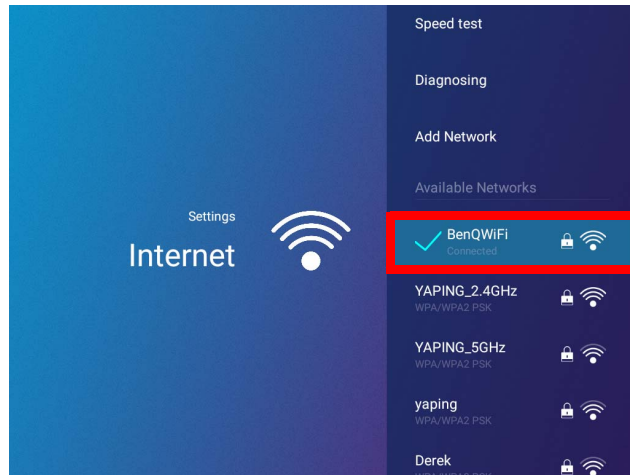

- To connect to a hidden wireless network select **Add A Network** and enter the SSID, security setting, and password for the network.
- The list of available wireless networks will be refreshed every 10 seconds. If the desired SSID is not listed please wait for refreshing to complete.

7. If you chose a secured SSID for the first time, a window appears prompting you to enter the appropriate password. Use the virtual keypad to enter the password. After you have entered the password, select **Next** and the projector will automatically connect.



- The password will be stored in the projector's memory. In the future, if you select the same SSID again, you will not be prompted to enter a password unless you delete the SSID from the projector's memory.
- If the password is typed incorrectly, you can select either re-enter the password or press the back button ↶ to return to the list of SSIDs.

8. Once you have successfully connected to the wireless AP, a wireless connection icon will appear at the top left corner of the **BENQ Launcher** interface. You can now connect your devices wirelessly to the projector to cast your device's screen.

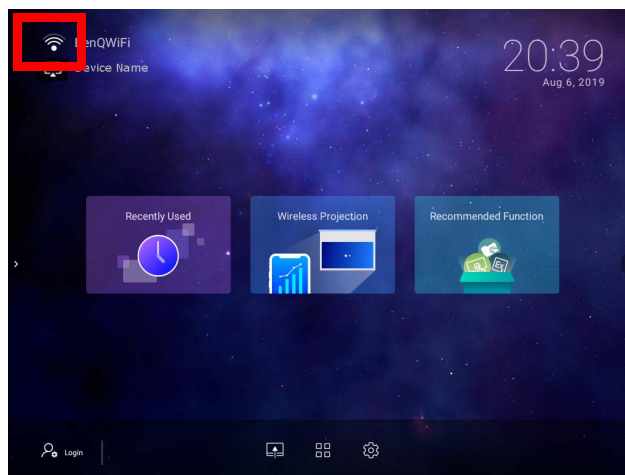

Wireless Projection for iOS & macOS®

To connect an iOS device to the projector and cast your device's screen via AirPlay:

1. On the home screen of the **BenQ Launcher** interface, select **Wireless Projection** and press **OK**.

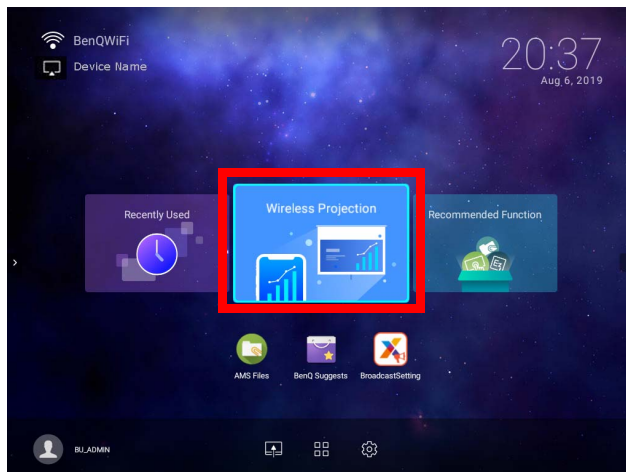

2. In the **Wireless Projection** menu, select **iPhone** and press **OK**.

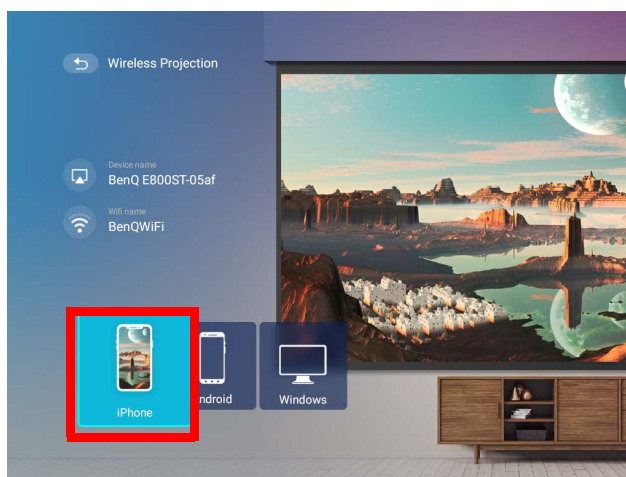

3. On your iOS mobile device's wireless network menu connect to the wireless network shown on the **Wireless Projection for iPhone** screen and then select **Next**.

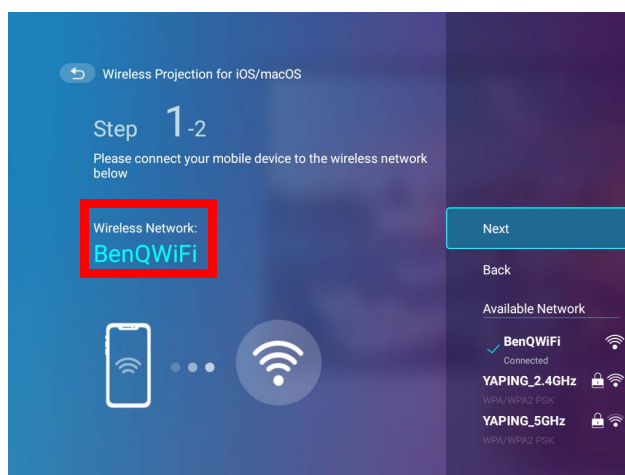

4. Follow the instructions shown on the **Wireless Projection for iPhone** screen to project your iOS device's screen via AirPlay.

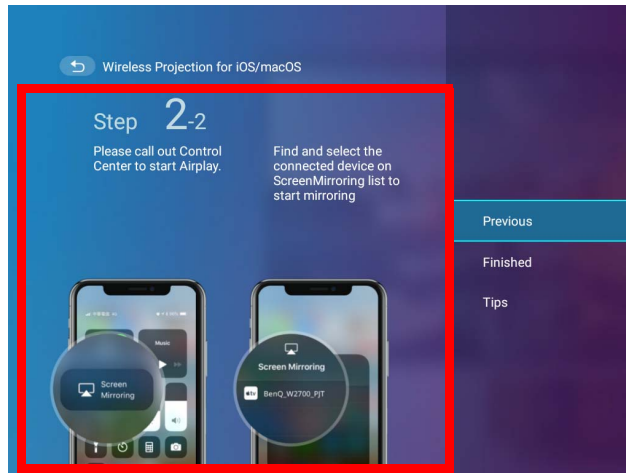

5. Select **Finished** on the **Wireless Projection for iPhone** menu to finish the tutorial and return to the home screen.

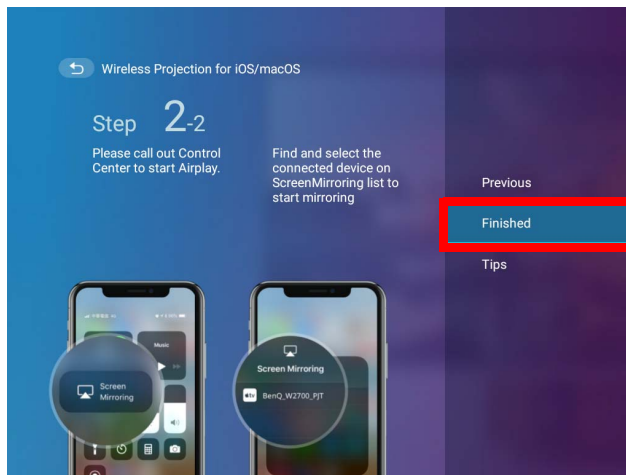

The quality of the wireless projection may depend on the quality of the wireless signal along with the screen mirroring compatibility of the mobile device.

Once you have finished projecting, disable AirPlay on your iOS device to end the connection.

Wireless Projection for Android™

To connect an Android™ device to the projector and cast your device's screen:

1. On the home screen of the **BenQ Launcher** interface, select **Wireless Projection** and press **OK**.

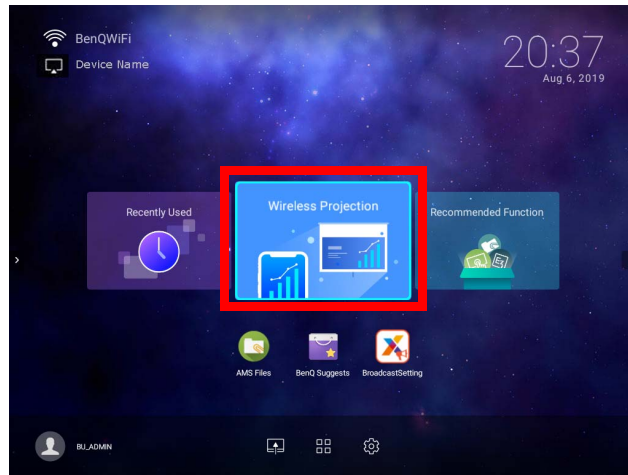

2. In the **Wireless Projection** menu, select **Android** and press **OK**.

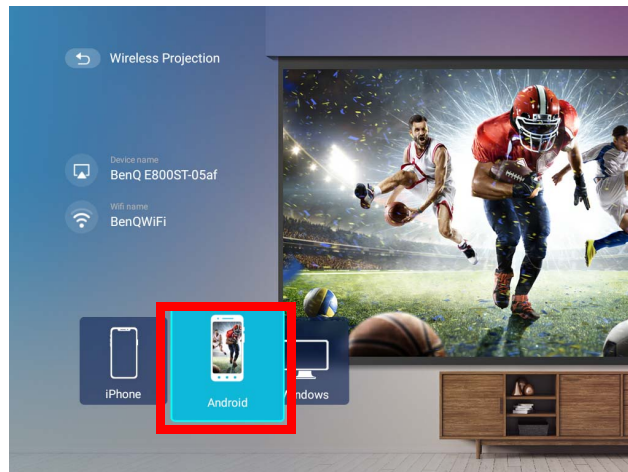

3. On your Android mobile device's wireless network menu connect to the wireless network shown on the **Wireless Projection for Android™** screen and then select **Next**.

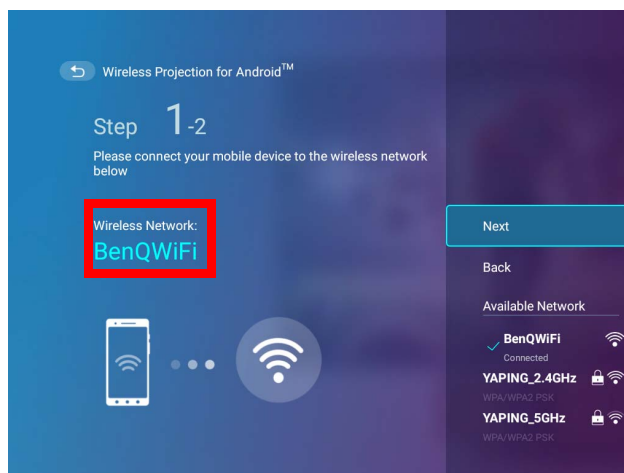

4. Follow the instructions shown on the **Wireless Projection for Android™** screen to project your Android device's screen.

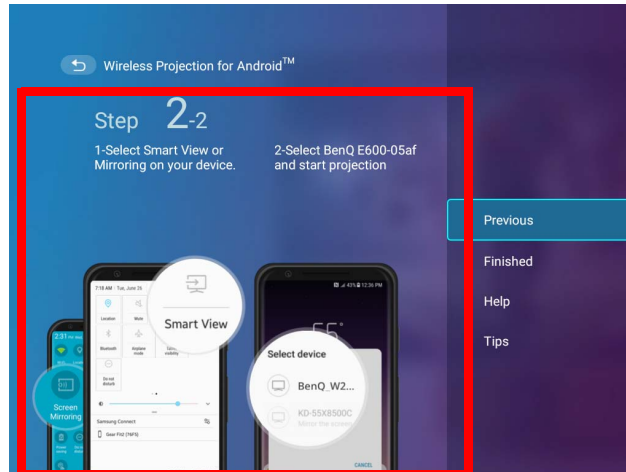

5. Select **Finished** on the **Wireless Projection for Android™** menu to finish the tutorial and return to the home screen.

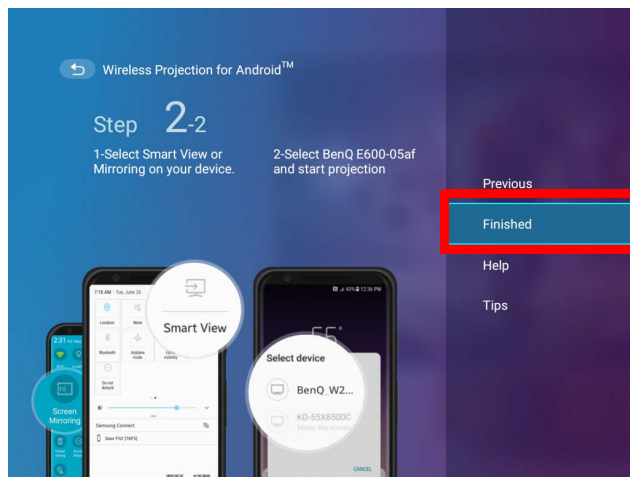

The quality of the wireless projection may depend on the quality of the wireless signal along with the screen mirroring compatibility of the mobile device.

Once you have finished projecting, disable screencasting on your Android device to end the connection.

Wireless Projection for PC

To connect an PC to the projector and cast your PC's screen:

1. On the home screen of the **BenQ Launcher** interface, select **Wireless Projection** and press **OK**.

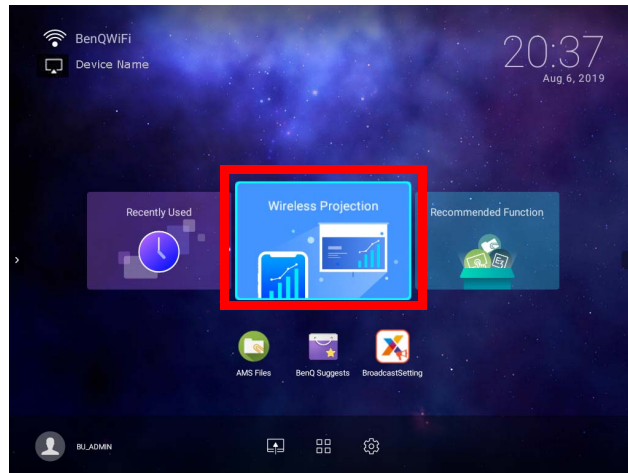

2. In the **Wireless Projection** menu, select **Windows** and press **OK**.

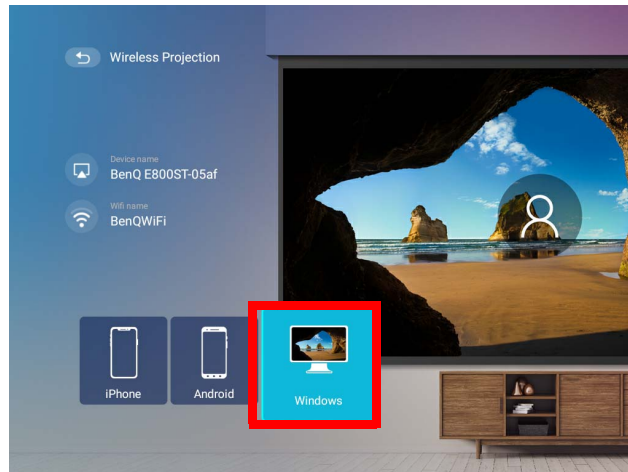

3. On your PC's wireless network menu connect to the wireless network shown on the **Wireless Projection for Windows** screen and then select **Next**.

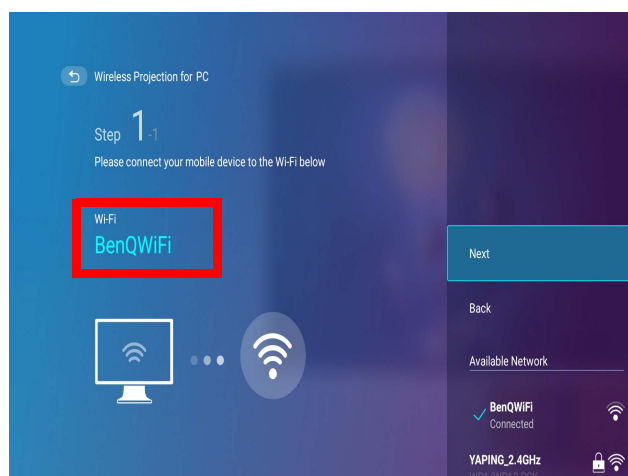

4. Follow the instructions shown on the **Wireless Projection for Windows** screen to project your PC's screen.

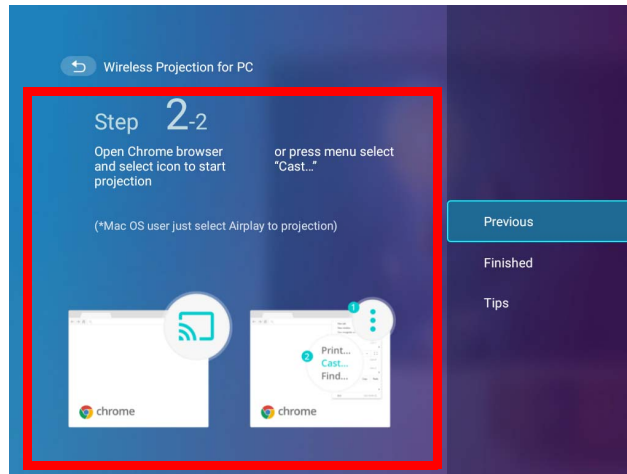

5. Select **Finished** on the **Wireless Projection for Windows** menu to finish the tutorial and return to the home screen.

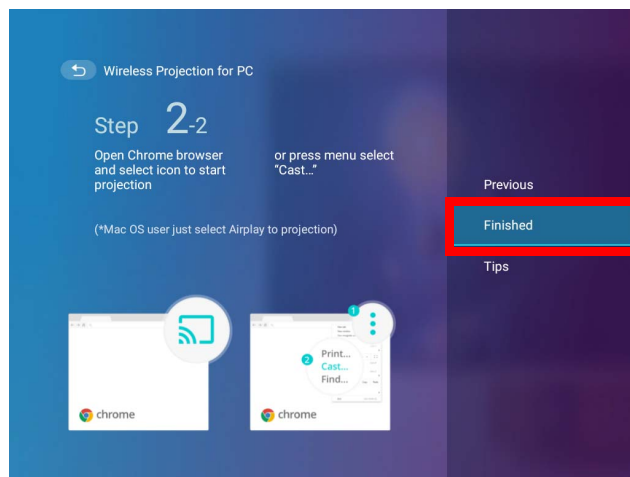



The quality of the wireless projection may depend on the quality of the wireless signal along with the screen mirroring compatibility of the PC.

Once you have finished projecting, disable screencasting on your PC to end the connection.

YouTube Broadcast

To connect a mobile device to the projector and broadcast your device's YouTube screen:

1. Make sure your projector and the mobile device are connected to the same wireless AP. To connect your projector to a wireless network, see [Connecting the projector to a wireless network on page 41](#).
2. Launch the YouTube app on your mobile device.
3. On the upper-right corner of your YouTube screen, click the  icon.
4. A list of available devices is displayed. Choose to connect to your projector. The YouTube screen is casting to your projector. Note that options and procedures may vary by app version or OS version. Follow the on-screen instructions to select your projector to cast.
5. To end the connection / broadcasting, click the  icon on the upper-right corner of your device's YouTube screen.

Wireless Hotspot

In situations where the projector is out-of-range of a wireless network (for example while on a camping trip), you can configure the projector to act as a wireless hotspot to create a closed network for devices to connect directly to the projector via a wireless connection and to project files from their local storage.

 The projector will have no access to the Internet while in wireless hotspot mode.

To create a wireless hotspot:

1. Install the wireless dongle provide into the wireless dongle port (see [Installing the wireless dongle on page 8](#)).
2. Power on the projector (see [Starting up the projector on page 22](#)).
3. On the home screen of the **BenQ Launcher** interface select the **Settings** button and press **OK**.

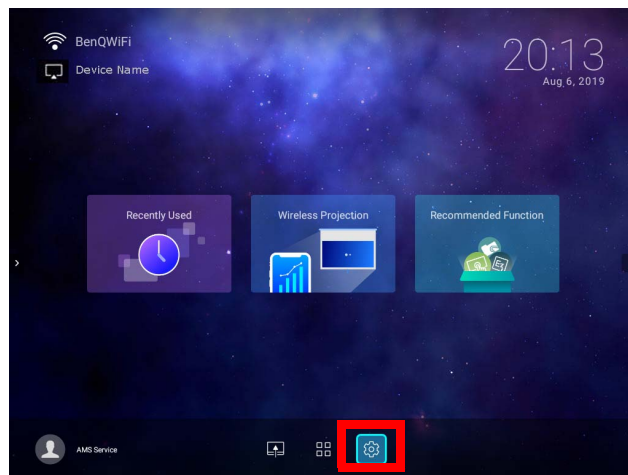

4. Select **Hotspot** and press **OK**.

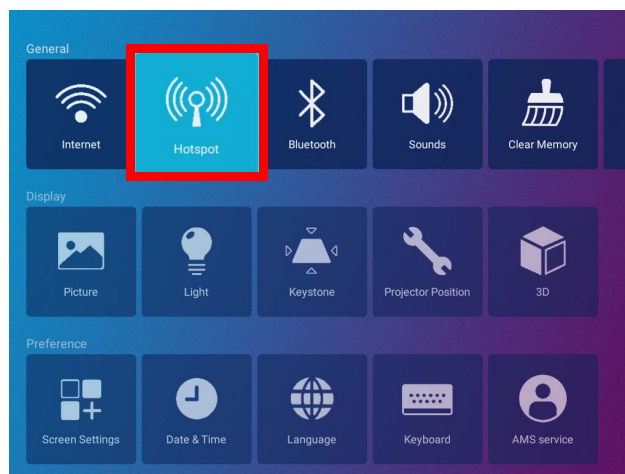

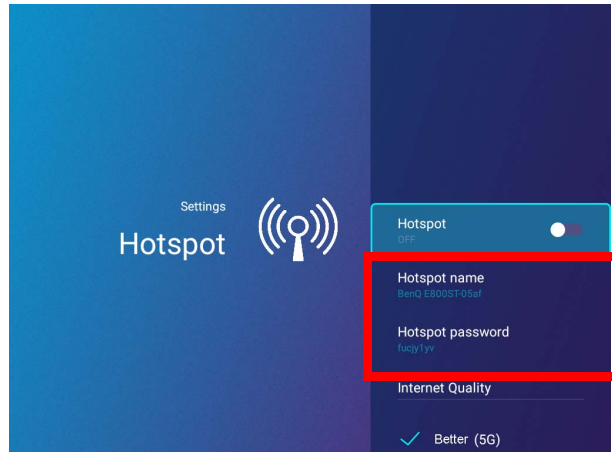

5. (Optional) Select **Hotspot Name** and/or **Hotspot Password** and press **OK** to change the name and/or password of the wireless hotspot.

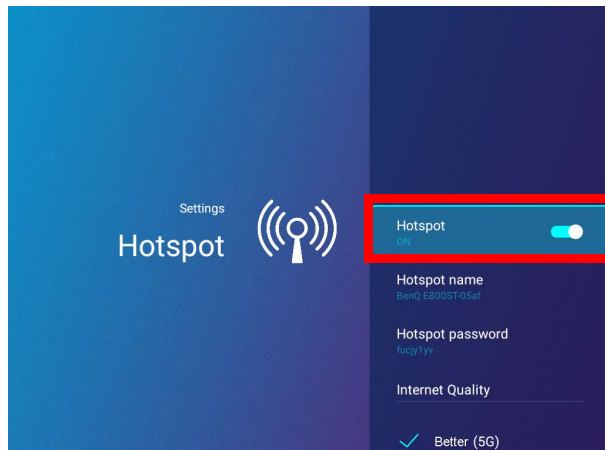

 You can only change the **Hotspot Name** and **Hotspot Password** when **Hotspot** is disabled.

6. Select **Hotspot** and press **OK** to enable wireless hotspot.



 The projector will have no access to the Internet while in wireless hotspot mode.

7. Once wireless hotspot is enabled, use the name shown in the **Hotspot Name** field as the SSID to connect to from your mobile device's wireless menu and use the password shown in the **Hotspot Password** field as the connection password.

8. If the wireless hotspot can not be found by your device, select **Normal (2.4G)** under the **Internet Quality** heading.

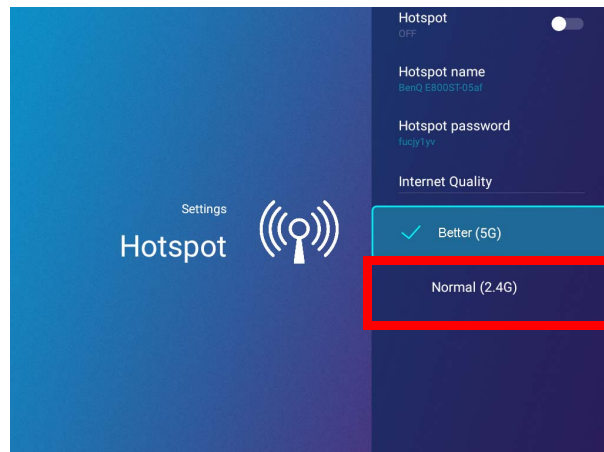

After the wireless hotspot is setup, follow the corresponding connection instructions described in the previous section(s) to connect to the projector directly and cast your device's screen.

External Storage Connections

Connecting a flash drive

Connect a USB-A flash drive to the **USB-1** or **USB-2** port at the rear of the projector to play files stored on the flash drive.

- If you want to play media from a flash drive while the projector is set to the **HDMI** or **PC/YPbPr** input source, you must first return to the **BenQ Launcher** interface by pressing the source button  or the **LAUNCHER** button on the remote control and then selecting **BenQ Launcher**.

To play files stored on a flash drive:

1. Connect the USB-A flash drive to the **USB-1** or **USB-2** port at the rear of the projector.
2. Choose one of the following options:
 - Press the source button  on the projector or remote control.
 - Select the source button on the **BenQ Launcher** home screen and press **OK**.

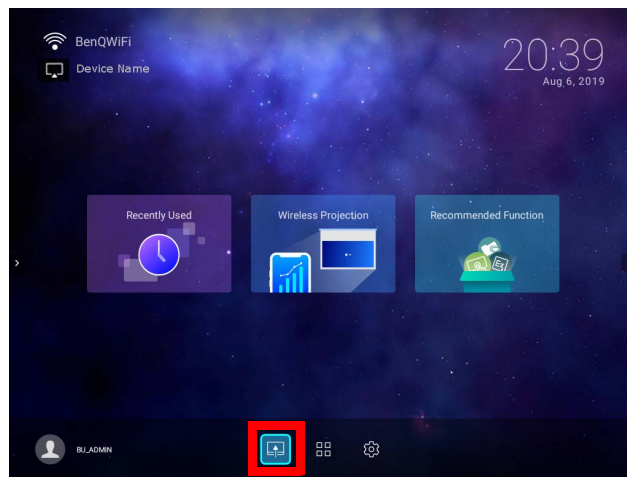

3. Select **File Manager** in the **Source** menu and press **OK**.

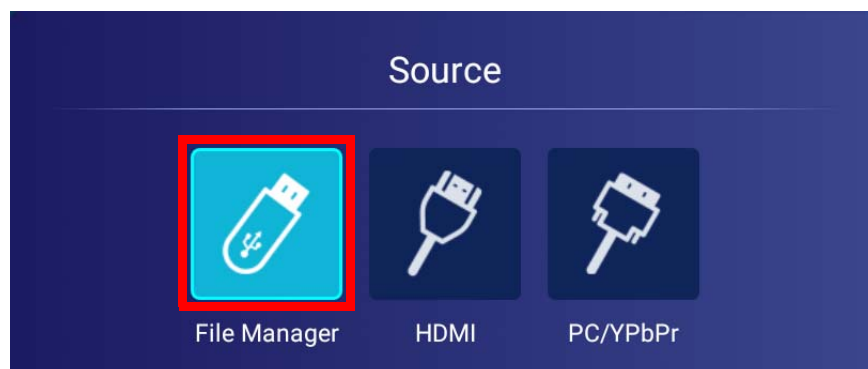

4. The **AMS Files** app will launch. Select the flash drive where the media file you want to play is located in the **Local Device** list and press **OK**.

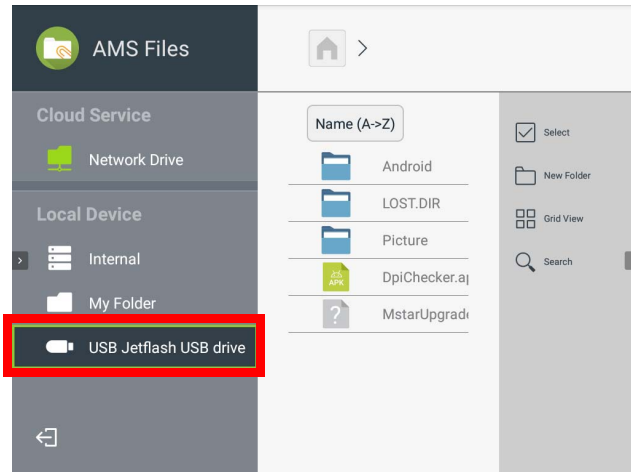

5. Navigate to the folder where the media file you want to play is located and press **OK**.

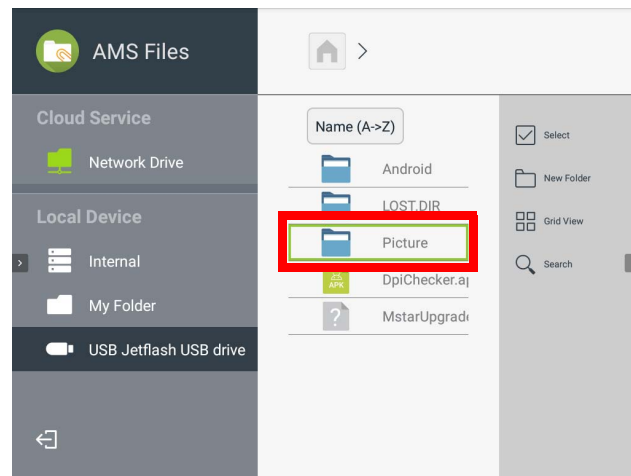

6. Select the media file you want to play and press **OK**.

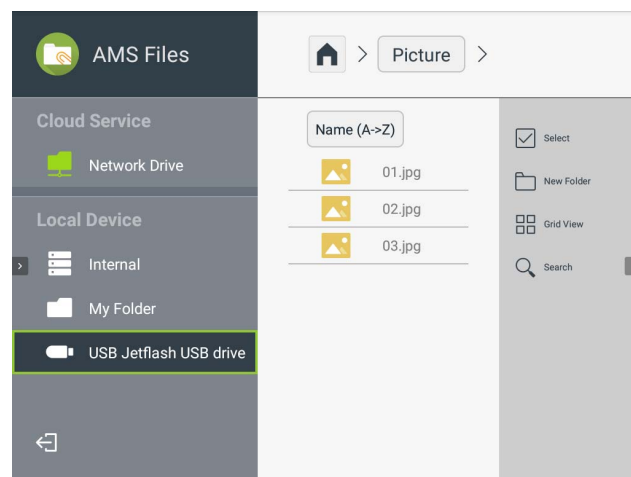

7. The media file will open in the media player app.



To remove a USB flash drive properly, click  from the bottom-right corner of the **BenQ Launcher** home screen and select the flash drive from the list. Follow the on-screen instructions to remove.



Bluetooth Connections

The projector is able to connect to a Bluetooth-enabled speaker or headphones to output audio directly for greater sound, particularly in outdoor settings.



- The Bluetooth connection does not support any data transfer as the projector only allows Bluetooth connections for audio output.
- You may not use the projector to broadcast audio from a Bluetooth-enabled mobile device.

Pairing/Connecting to a Bluetooth speaker or headphones

Pairing is the process by which your projector creates a connection to a Bluetooth speaker or headphones for the first time. Once both devices have been successfully paired each device will have the corresponding device's pairing information stored internally and both will be able to connect automatically when they are within an ~5 meter range of each other and Bluetooth is enabled on the projector.

To pair your projector to a Bluetooth speaker or headphones:

1. Install the provided wireless dongle into the wireless dongle port (see [Installing the wireless dongle on page 8](#)).
2. Power on the projector (see [Starting up the projector on page 22](#)).
3. On the home screen of the **BenQ Launcher** interface select the **Settings** button and press **OK**.

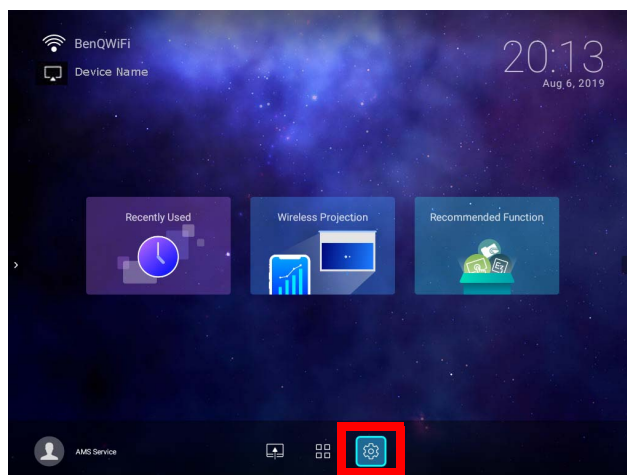

4. Select **Bluetooth** and press **OK**.

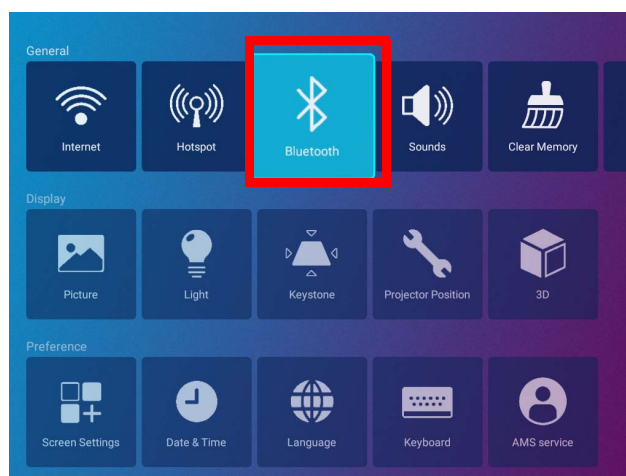

5. Select **Bluetooth** and press **OK** to enable Bluetooth.

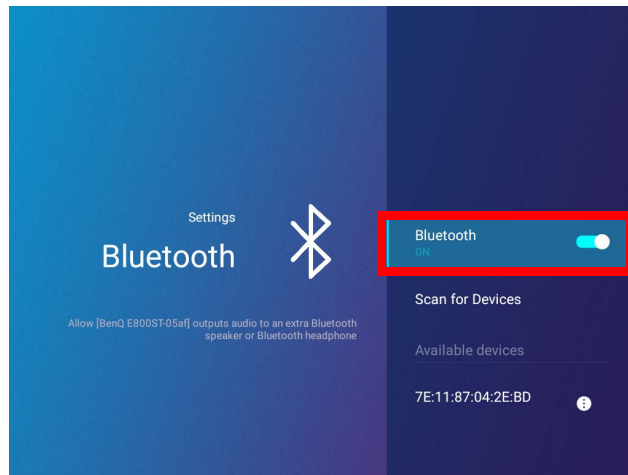

6. Activate Bluetooth-pairing mode on the speaker or headphones.

7. Select the speaker or headphones from the **Device List** in the **Bluetooth** setting menu and press **OK**.

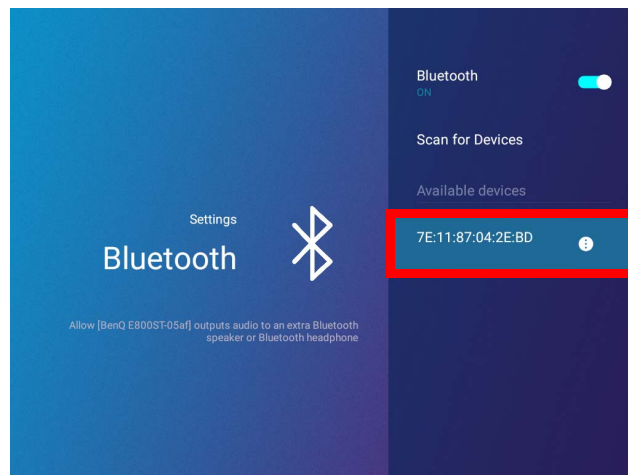

8. When the projector and speaker or headphones have successfully connected the device listing in the Bluetooth setting menu will be labeled **Connected**, you can now output the audio from the projector to the speaker or headphone.

Once you have successfully paired your projector with the Bluetooth speaker, pairing information will be stored on both devices and a connection will automatically be made when Bluetooth is enabled on both devices and both devices are within range of each other.



- If you replace the wireless dongle on your projector anytime after you have paired your projector with a Bluetooth device you will need to re-pair your projector to the device in order to create a Bluetooth connection.
- The quality of the Bluetooth transmission may depend on the quality of the Bluetooth signal along with the compatibility of the mobile device.

Ending the Bluetooth connection

In cases where you want to disconnect a speaker or headphones from the projector and connect to another speaker or headphones follow the steps below:

1. On the home screen of the **BenQ Launcher** interface select the **Settings** button and press **OK**.
2. Select **Bluetooth** and press **OK**.
3. Select the already connected speaker or headphones from the **Device List** in the **Bluetooth** setting menu and press **OK**.
4. Confirm that you want to disconnect the speaker or headphones from the projector.
5. Activate Bluetooth-pairing mode on the new speaker or headphones.
6. Select the new speaker or headphones from the **Device List** in the **Bluetooth** setting menu and press **OK**.

Deactivating the Bluetooth speaker or headphones

To deactivate Bluetooth on the projector so that it no longer outputs its audio to a separate speaker or headphones:

1. On the home screen of the **BenQ Launcher** interface select the **Settings** button and press **OK**.
2. Select **Bluetooth** and press **OK**.
3. Select **Bluetooth** and press **OK** to disable Bluetooth.

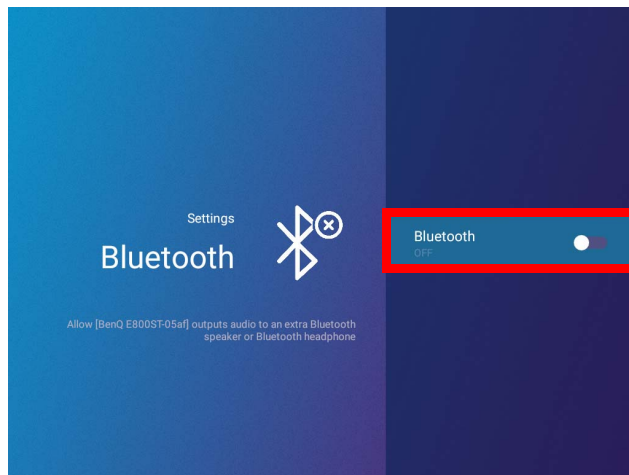

Apps

To access all the apps installed on the projector, select the all apps button in the tool bar section of **BenQ Launcher**. Your projector comes pre-installed with the following apps: **File Manager**, **BenQ Suggests**, **X-Sign Broadcast**, and **WPS Office**.

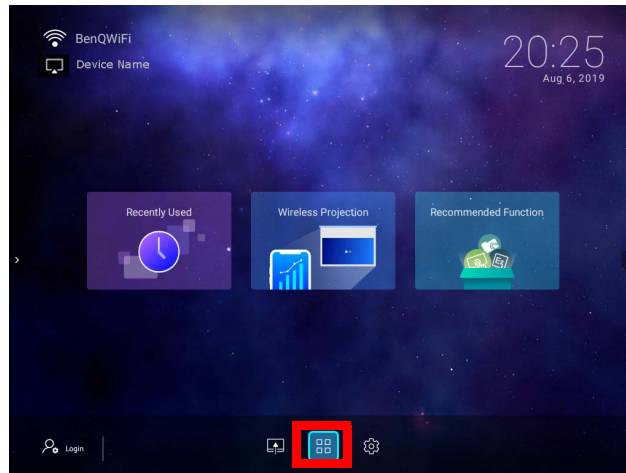

Certain apps require the use of a mouse and/or keyboard to operate. It is suggested that you connect a mouse and/or keyboard to the projector before opening any apps from the **Shortcut** section.

AMS Files

The **AMS Files** app allows you to browse, open, and manage files stored on cloud-based storage drives linked to the corresponding AMS login account, the projector's internal storage, or in connected storage devices (e.g. a USB flash drive).

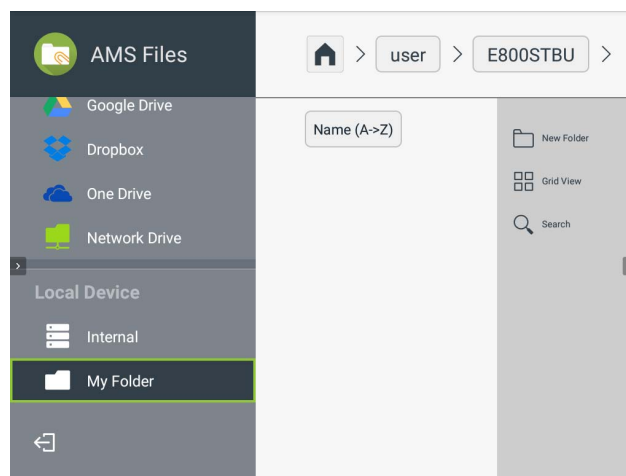

The main menu classifies storage types into three categories:

Cloud Service - Allows you to access files stored on cloud-based storage services (e.g. Google Drive, Dropbox, One Drive, etc.) linked to your AMS login account.



- To access cloud-based files your projector must be connected to a wireless network with Internet access and logged in using an AMS account which has a cloud service linked to it. See [Linking a cloud storage drive to your AMS login on page 59](#) for more details.
- A link icon  next to **Google Drive**, **Dropbox**, or **One Drive** in the **AMS Files** menu indicates that the corresponding cloud storage account has been bound to the current AMS login account.

Network Drive - Allows you to access files stored on a network-based storage space (e.g. a server). In order to link to the network drive you must first obtain information for the server including domain name, IP address, and login information and enter it into the **Network Drive** menu.

Local Device - Allows you to access files stored on the projector's internal drive (either generally or in each AMS login account's personal folder), or on external flash drives connected to the projector's **USB-1** or **USB-2**. See [Connecting a flash drive on page 53](#) for details on accessing files on external flash drives.

Linking a cloud storage drive to your AMS login

By linking a cloud-based storage drive to your AMS login, you will be able use **File Manager** to access any files stored on the drive from any device.

To link a cloud storage drive to your AMS login:

1. Log into the AMS website using the account you want to link a cloud drive to.
2. Click on **Personal Settings** in the sidebar.

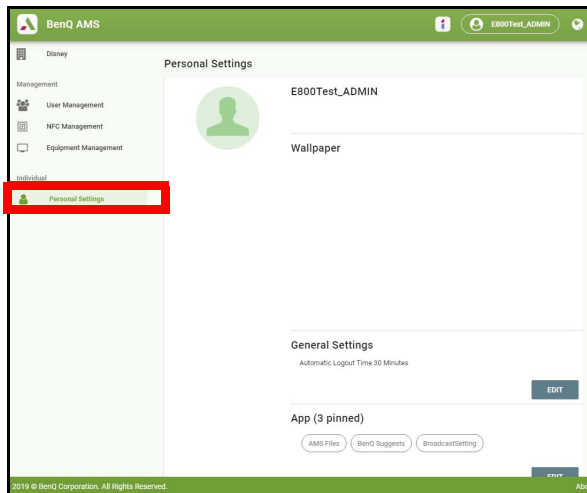

3. Scroll down to the **Cloud Storage** section and click the **LINK** button next to the cloud storage service you want to link to your AMS account.

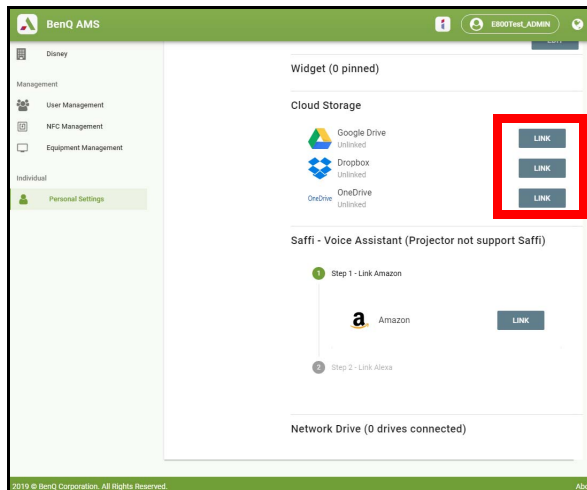

4. Enter the sign-in information for your cloud storage account in the sign-in page that opens.

Once a cloud storage drive is linked, you can view any file stored on that drive via the **File Manager** app after logging into your AMS account on the projector.

For a full description of the features of the AMS service, including instructions on how to setup and manage accounts, refer to the **AMS User Manual** which you can download at the following URL: <https://www.benq.com/en-us/business/index.html> > your Projector Model > **Downloads** > **User Manual**.

BenQ Suggests

The **BenQ Suggests** allows you to view apps suggested by BenQ for download.

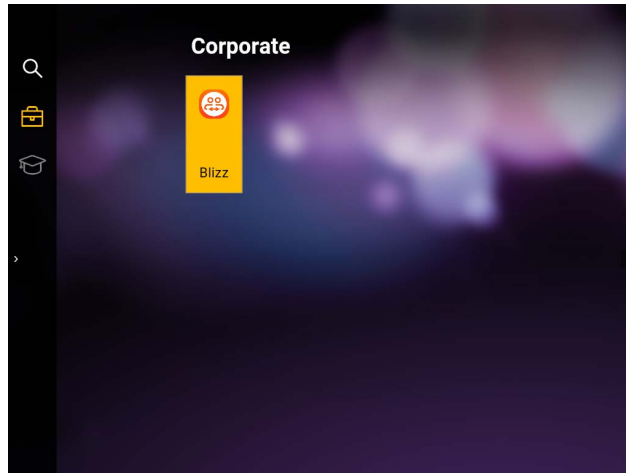

Select the category on the left panel to browse the suggested apps based on the type. Select an app from the selected category and press **OK** to view a basic description of the app and access the download link.



Certain apps require the use of a mouse and/or keyboard to operate. It is suggested that you connect a mouse and/or keyboard to the projector before downloading any apps from **BenQ Suggests**.

X-Sign Broadcast

X-Sign Broadcast is an app that allows the projector to broadcast announcements or messages created and scheduled on the X-Sign website using a BenQ Identity and Access Management (IAM) account.

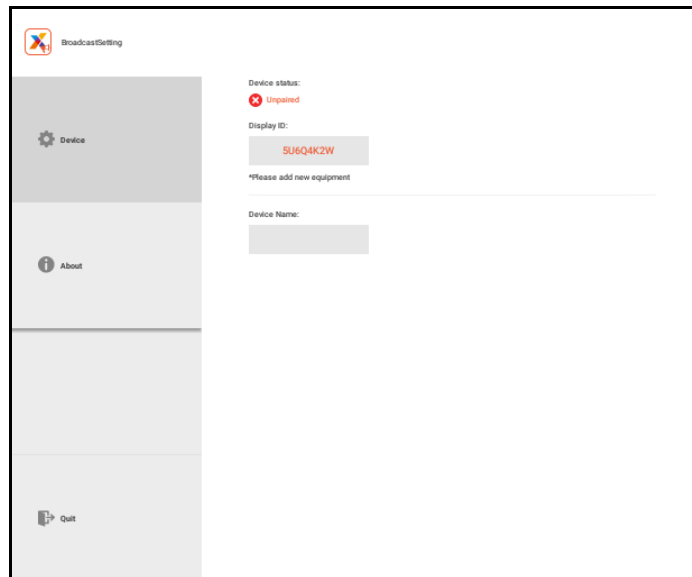

For a full description of the features of **X-Sign Broadcast**, including instructions on how to create, schedule, and broadcast messages, refer to the **X-Sign Broadcast User Manual** which you can download at the following URL:

<https://www.benq.com/en-us/business/ifp/x-sign-broadcast/download.html>.

WPS Office

The **WPS Office** app allows you to open document files including PDFs as well as Microsoft Word, PowerPoint and Excel documents.

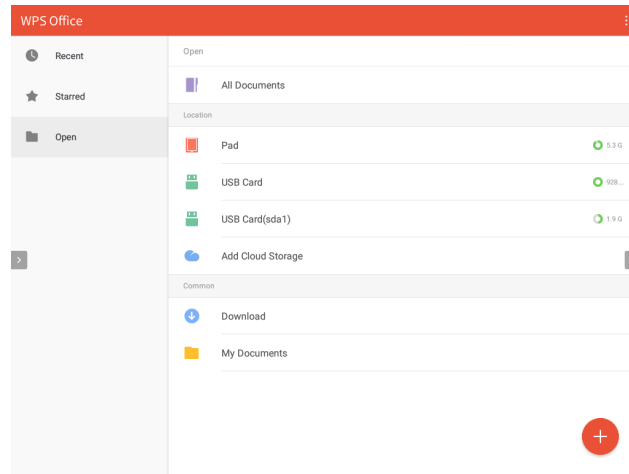

To edit a file with **WPS Office**:

1. Open the file using the steps described in [Connecting a flash drive on page 53](#).
2. Select **Open** () on the left panel to browse and open a file located in either the projector's internal memory or an external storage device.

Select the function menu on the top panel to access the file format's various functions.



The description below is for a PowerPoint file, the function menus for other file formats will vary.

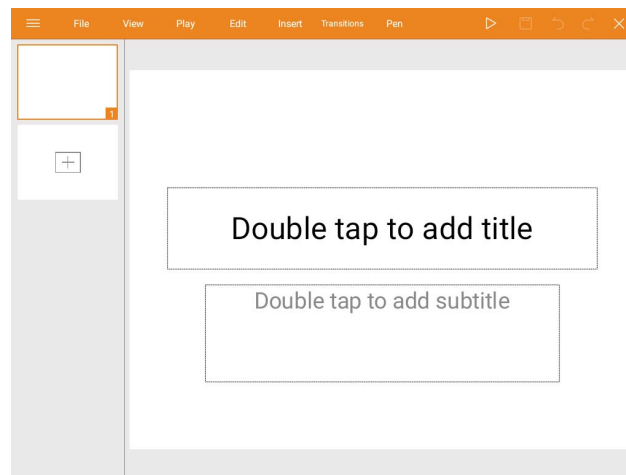

Function	Description
File	Select to open, save, share, print, and manage your presentations.
View	Select to change or edit the presentation views.
Play	Select to start or set up a slide show.
Edit	Select to edit the content or format of the slides.
Insert	Select to insert tables, pictures, charts, comments, video, or audio.
Transitions	Select to apply or adjust the timing of a transition.

Function	Description
Pen	Select to write, draw, paint or sketch to the slides.
Play (▶)	Select to start a slide show.
Save As (📁)	Select to save the presentation file on either the display's internal memory, an external storage device, or cloud storage.
Undo (↶)	Select to undo an action.
Redo (↷)	Select to redo the last action.
Close (✕)	Select to close the presentation file.
Back (←)	Select to return to the previous page.
Next (→)	Select to go to the next page.
Exit (⏏)	Select to exit WPS Office.

Navigating the **Settings** Menu

About the **Settings** menu

To let you make various adjustments or settings on the projector, its wireless connections, and the projected image, **BenQ Launcher** provides a **Settings** menu. Under the **Settings** menu are sub-menus for various settings.

To access the **Settings** menu, in the **BenQ Launcher** home screen select the **Settings** button.

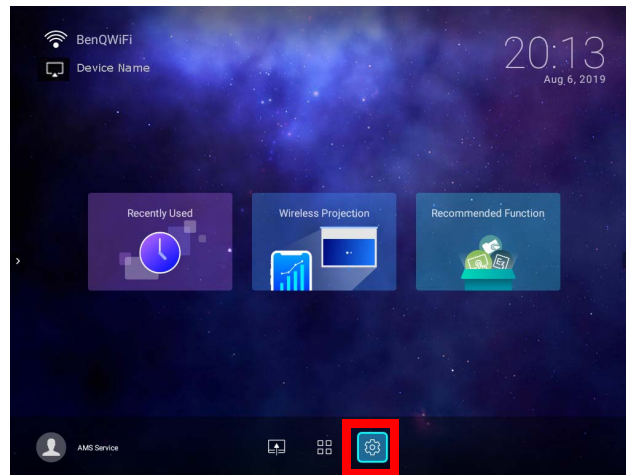

If the projector is not of the latest version of firmware, a red dot will appear on the **Settings** icon. In such a circumstance, users can go to the **About > Software Update** menu and then select **Update** to start firmware update. The red dot will disappear when the projector is updated with the latest version of firmware. See [Checking for system update on page 33](#) for more information.

Under the **Settings** menu there are three subcategories: **General**, **Display**, and **Preference**.

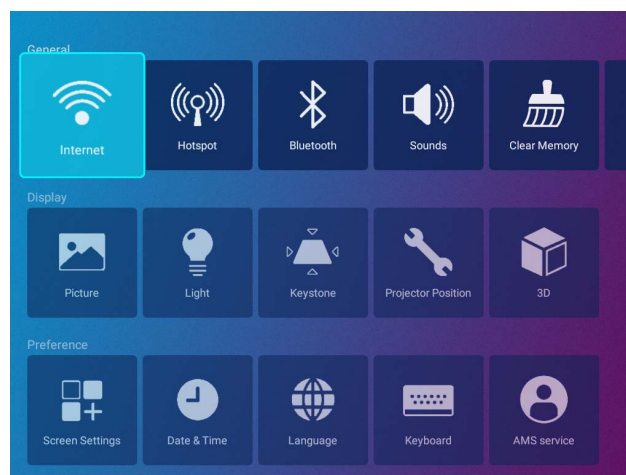

The sub-menus in the **Display** category feature only a partial number of items that adjust your projector's display settings, for a full menu of display related settings enter the **Advanced OSD** settings menu. See [Advanced menu on page 86](#) for a listing of the full **Display** settings.



Using the **Settings** menu

To access the various **Settings** menus:

- Use the left and right arrow keys (◀/▶) to move through the main **Settings** menus.
- Use **OK** to select the desired menu.
- When configuring items within a menu:
 - Use the up and down arrow keys (▲/▼) to move to the item you want to configure.
 - Use left and right arrow keys (◀/▶) to toggle through the available options.
 - Use **OK** to enable/disable options or select sub-menu options.
- Use the back button ↶ to return to the main **Settings** menu.
- Use the home button 🏠 to return to the **BenQ Launcher** home screen.

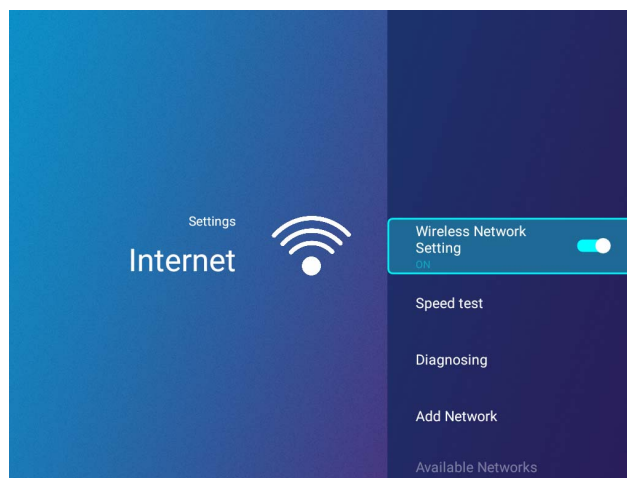

Internet



<p>Wireless Network Settings</p> 	<p>Enables a wireless network connection for the projector. See Connecting the projector to a wireless network on page 41 for details.</p> <p>This function is only available when Hotspot is disabled.</p>
<p>Speed Test</p>	<p>Tests the speed of the projector's Internet connection.</p>
<p>Diagnosing</p>	<p>Diagnoses the status of the projector's Internet connection.</p>
<p>Add Network</p>	<p>Allows you to add a specific network that may be hidden or undetected in the Available Networks. Once selected you will be prompted to enter the SSID and security settings for the network.</p>
<p>Available Networks</p> 	<p>Lists the available wireless access points which the projector can connect to. See Connecting the projector to a wireless network on page 41 for details.</p> <p>Available Networks is only available when Wireless Network Settings is disabled.</p>

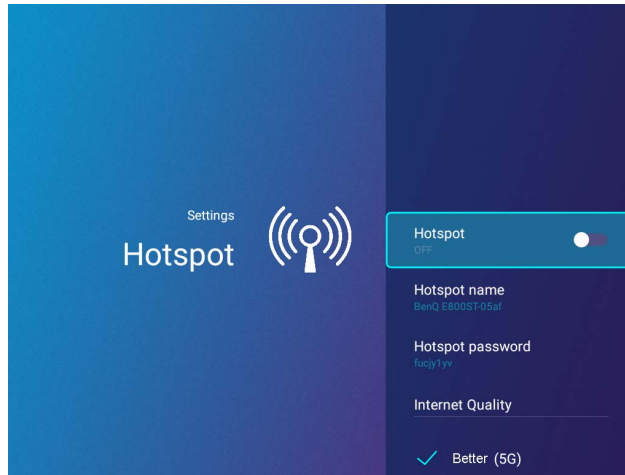

Hotspot

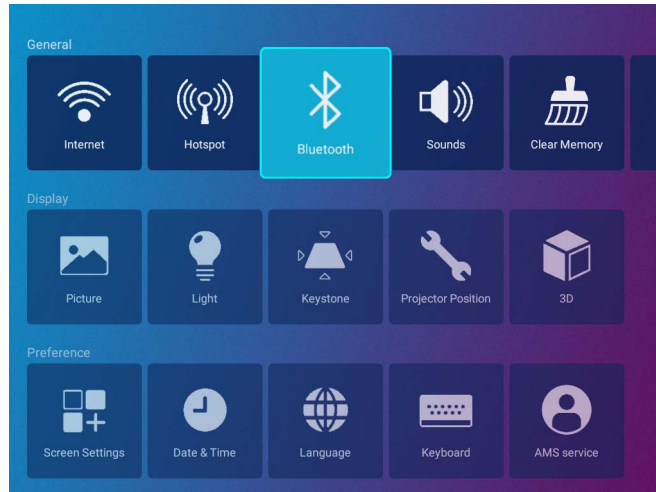

<p>Hotspot</p>	<p>Enables wireless hotspot for the projector, allowing other devices to connect to the projector directly. See Wireless Hotspot on page 50 for details.</p>
<p>Hotspot Name</p>	<p>  Sets the name for the projector’s wireless hotspot, which appears in the wireless network list for devices looking to connect directly to the projector. The default name for the projector’s wireless hotspot is "BenQ E600-xxxx". The final four digits are the last four digits of its MAC Address. </p>
<p>Hotspot Password</p>	<p>  Sets the password for the projector’s wireless hotspot. The password needs to be at least 8 characters. </p>
<p>Internet Quality</p>	<p>Sets the frequency for the projector’s wireless hotspot signal. Available options include Better (5G) and Normal (2.4G).</p>

Bluetooth



Bluetooth	Enables Bluetooth for the projector, allowing the projector to output its audio to a Bluetooth speaker or headphones.
My Devices	<p>Lists of previously paired Bluetooth devices.</p> <p></p> <p>This function is only accessible when Bluetooth is enabled.</p>
Scan for Devices	<p>Refreshes the list of devices.</p> <p></p> <p>This function is only available when Bluetooth is enabled.</p>
Available Devices	<p>Lists the available Bluetooth devices which the projector can pair and connect to.</p> <p></p> <p>This function is only available when Bluetooth is enabled.</p>

Sounds

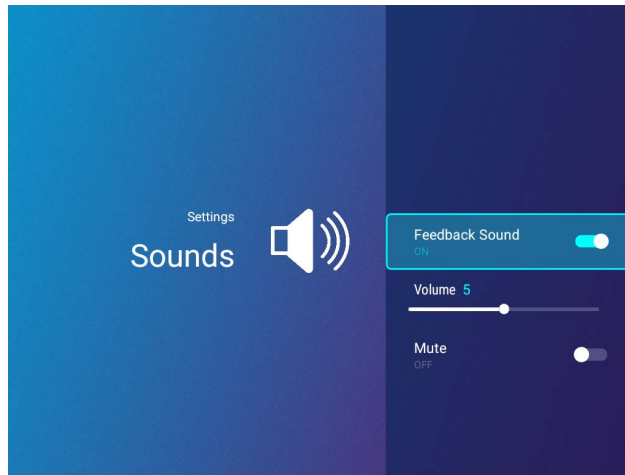

Feedback Sound	Enables/Disables feedback on the audio provided by the projector.
Volume	Adjusts the sound level for the projector.
Mute	Disables/Enables audio for the projector.

Clear Memory

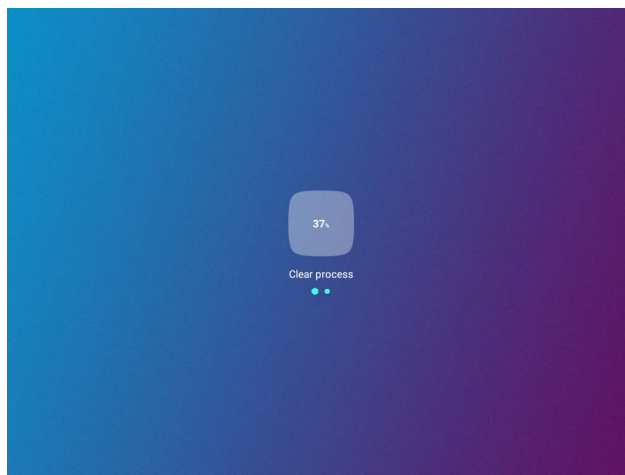

Clears out the memory of unnecessary files and boosts available RAM.

All Apps

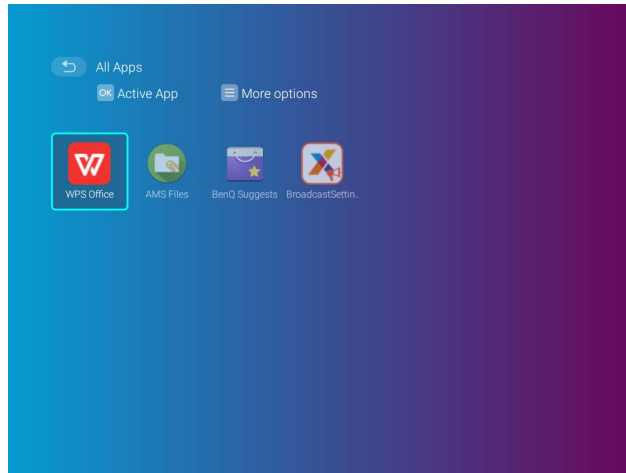

Select the **All Apps** menu to access all the apps that have been installed on the projector.

- Select an app and press **OK** to launch the app.
- Select an app and press the menu button (≡) to uninstall the app.



When **AMS Service** is enabled, **Guest AMS** accounts will not be allowed to uninstall apps in this menu.

Recently Used

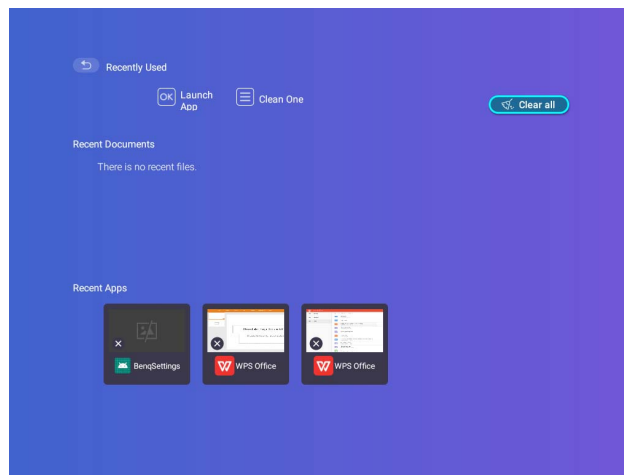

Select the **Recently Used** menu to access a list of apps that have been recently used.

- Select any icon and press the down button (▼) to remove the icon from the list of recently used apps.
- Select any icon and press the menu button (≡) to clear all icons from the list of recently used apps.

About



When **AMS Service** is enabled, this menu will not be accessible by **Guest** AMS accounts.

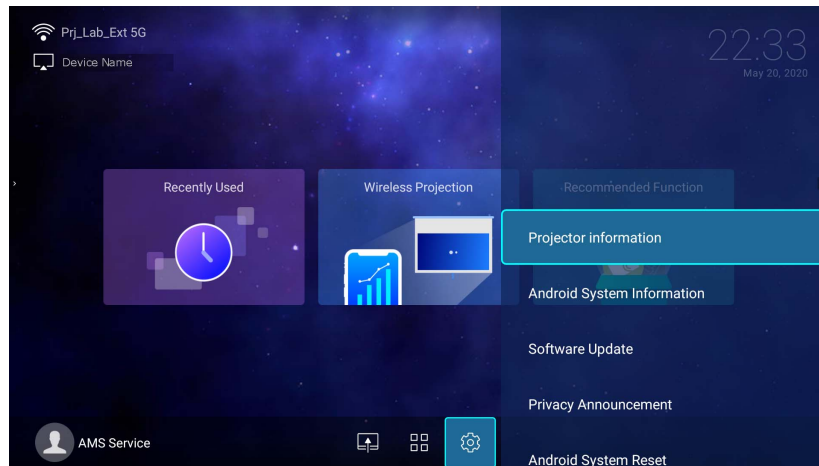

Projector Information	Displays information on the current status of the projector including the current Native Resolution, Picture Mode, Light Mode, Light Usage Time, Firmware Version, and Service Code.
Android System Information	Displays information on the Android operating system including Android Version, Ram, System storage, Internal storage, and MAC address.
Software Update	Allows you to update the Android operating system via an Over-The-Air (OTA) update or a USB flash drive. For more information see Checking for system update on page 33.
Privacy Announcement	Allows you to view and accept or reject BenQ's privacy policy.
Android System Reset	Returns all settings to the factory preset values.

Picture

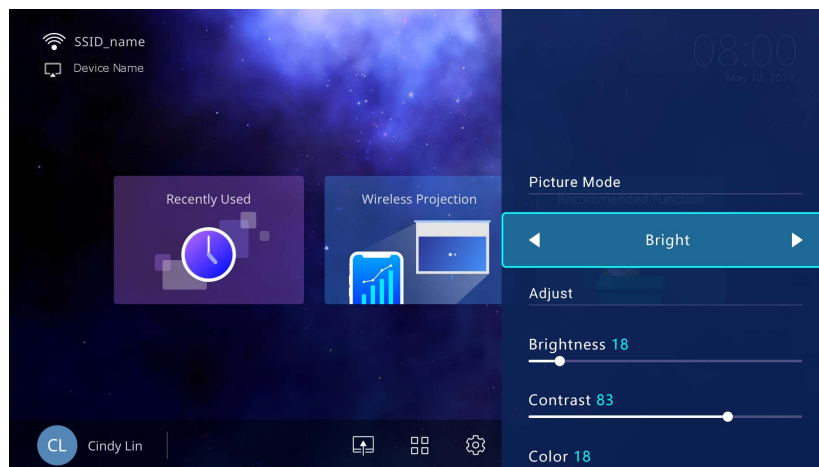

The options available for the **Picture** settings menu are the same as the options available in the OSD menu. See [Advanced menu on page 86](#) for the **Picture** settings options.

Light Settings

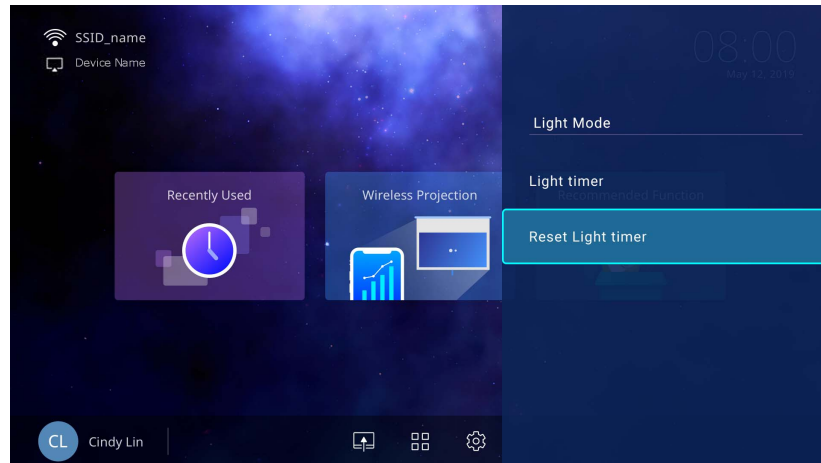

The options available for the **Light Settings** settings menu are the same as the options available in the OSD menu. See **Advanced menu on page 86** for the **Light Settings** settings options.

Keystone

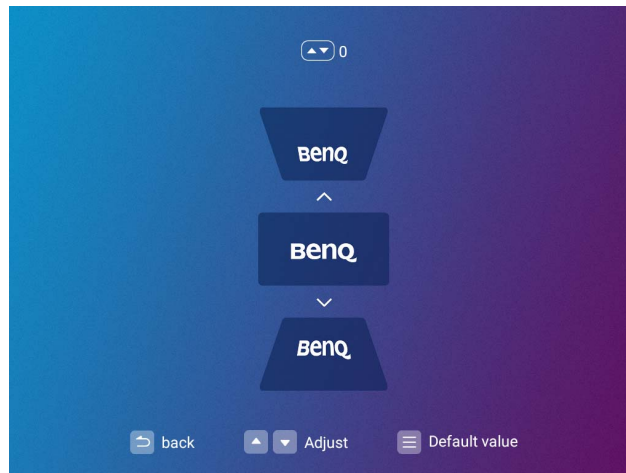

The options available for the **Keystone** settings menu are the same as the options available in the OSD menu. See **Advanced menu on page 86** for the **Keystone** settings options.

Projector Position

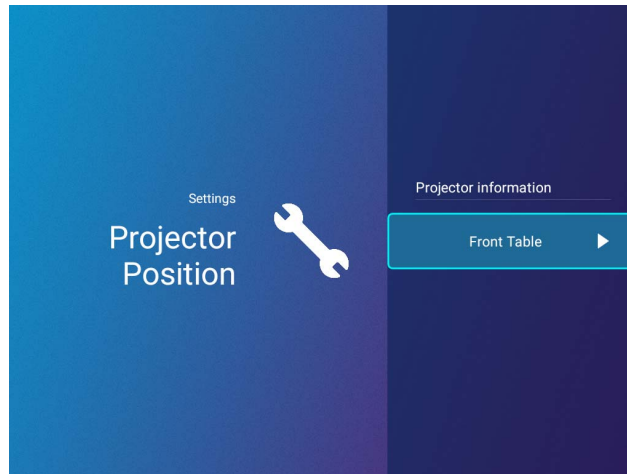

The options available for the **Projector Position** settings menu are the same as the options available in the OSD menu. See [Advanced menu on page 86](#) for the **Projector Position** settings options.

3D

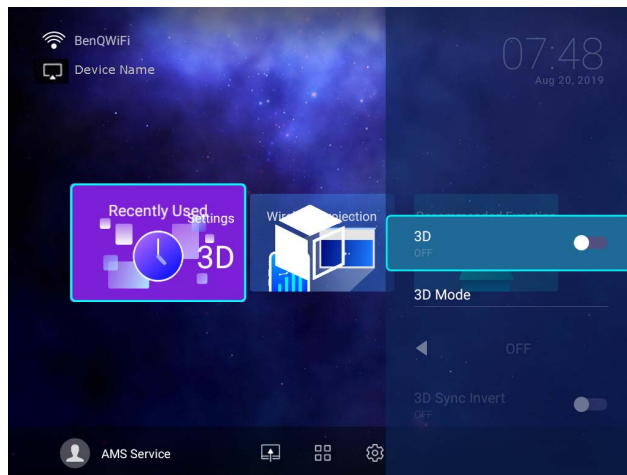

The options available for the **3D** settings menu are the same as the options available in the OSD menu. See [Advanced menu on page 86](#) for the **3D** settings options.

Screen Settings

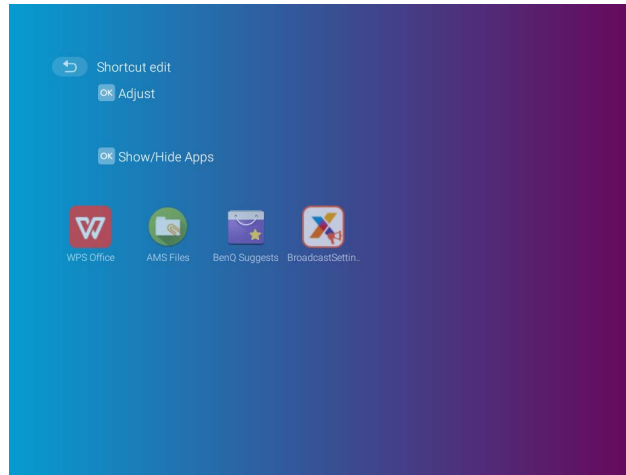

Shortcut

Sets which app shortcuts are displayed on the **BenQ Launcher** home screen and their sequence. The home screen requires at least one shortcut and allows up to ten shortcuts.

- **Auto:** Enables the projector to automatically arrange the sequence of app shortcuts on the home screen so that the most recently used app will appear first in the row.
- **Manual:** Enables the user to manually arrange which app shortcuts to be displayed on the home screen and their sequence. Press **OK** on an app in the **Adjust** menu and then press ◀/▶ to adjust the sequence of the apps in the apps shortcuts section. Press **OK** on an app in the **Show/Hide Apps** menu to check (show) or uncheck (hide) the shortcuts.





This function is only available when **Auto** is disabled.

Date & Time

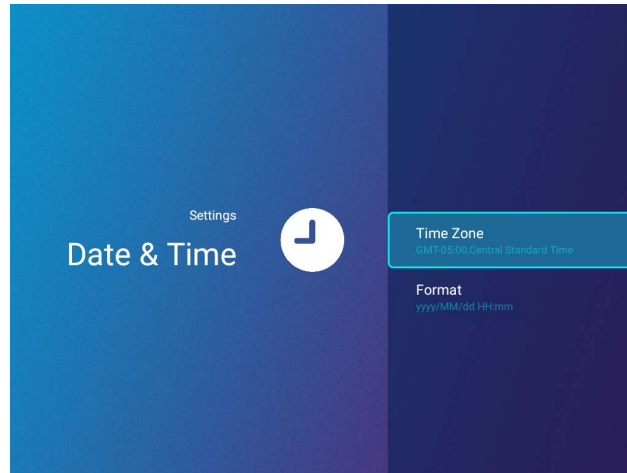

- When **AMS Service** is enabled, this menu will not be accessible by **Guest** AMS accounts.
- The projector's date and time information is linked to/synched with the Internet, and cannot be manually set. In instances when the projector does not have access to the Internet, the date and/or time information displayed may be incorrect.



<p>Time Zone</p>	<p>Sets the time zone for the projector</p>  <p>The Time Zone setting must be set to the correct region for the projector in order for the X-Sign Broadcast app to work correctly.</p>
<p>Format</p>	<p>Sets the date and time format as either HH:MM or YYYY/MM/DD HH:MM.</p>

Language



- When **AMS Service** is enabled, this menu will not be accessible by **Guest** AMS accounts.

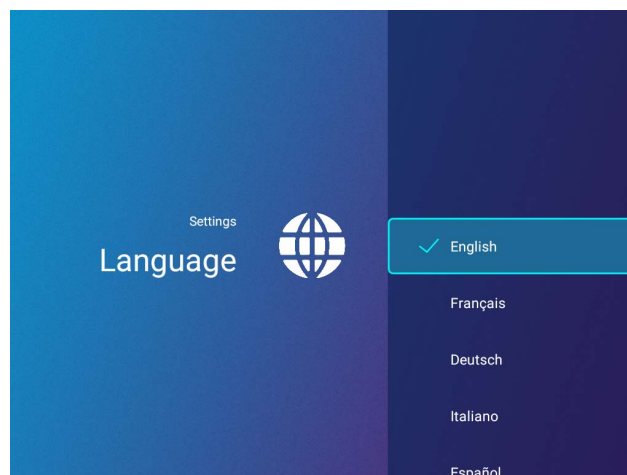



Sets the language for **BenQ Launcher**.

Keyboard

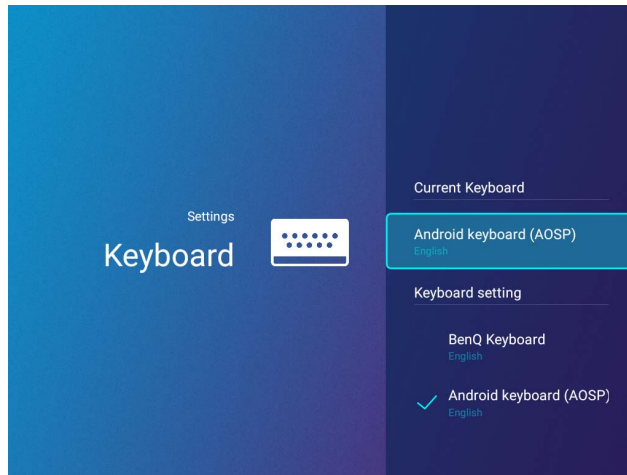

When **AMS Service** is enabled, this menu will not be accessible by **Guest** AMS accounts.



Current Keyboard	Displays the current keyboard setting.
Keyboard Settings	<p>Sets the projector’s virtual keyboard for inputting text. The available options are BenQ Keyboard and Android keyboard (AOSP).</p>  <p>To input Chinese characters, set the language preference to traditional Chinese or simplified Chinese, and set the keyboard to BenQ Keyboard.</p>

AMS Service



When **AMS Service** is enabled, this menu will not be accessible by **Guest** or **User** AMS accounts.

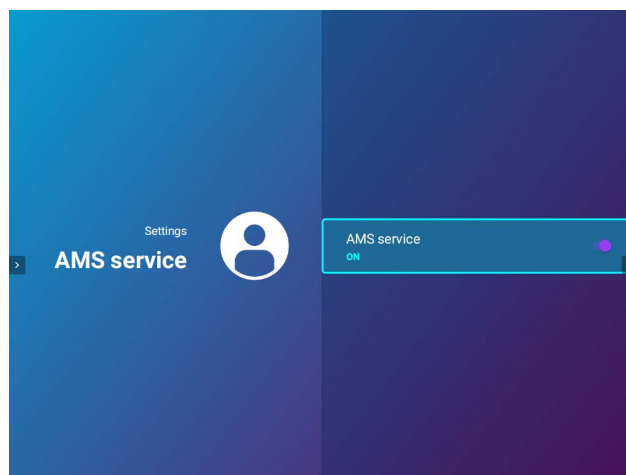

Select whether to enable or disable the BenQ Account Management System.

Operation (under non-Launcher source)

Using the projector menu under non-Launcher source

When the input signal is **HDMI** or **PC/YPbPr**, you can use 2 types of On-Screen Display (OSD) menus for making various adjustments and settings.

- **Basic** OSD menu: provides primary menu functions. (See **Basic menu on page 79**)
- **Advanced** OSD menu: provides full menu functions. (See **Advanced menu on page 80**)

To access the OSD menu, press  on the projector or remote control.

- Use the arrow keys (**▲/▼/◀/▶**) on the projector or remote control to move through the menu items.
- Use **OK** on the projector or remote control to confirm the selected menu item.

The first time you use the projector (after finishing the initial setup), Basic OSD menu displays.



The OSD screenshots below are for reference only, and may differ from the actual design.

Below is the overview of the **Basic** OSD menu.

	<p>1 Menu Type</p>	<p>4 Press OK to enter the menu.</p>
	<p>2 Main menu</p>	<p>5 Status</p>
	<p>3 Current input signal</p>	<p>6 Press  to go to the previous page or to exit.</p>

If you intend to switch from the **Basic** OSD menu to the **Advanced** OSD menu, follow the instructions below:

1. Go to **Basic Menu > Menu Type**.
2. Press **OK** and press **▲/▼** to select **Advanced**. Next time when you turn on the projector, you may access the **Advanced** OSD menu by pressing .

Below is the overview of the **Advanced** OSD menu.

1	Main menu & Main menu icon	5	Press ↶ to go to the previous page.
2	Sub-menu	6	Press ⚙️ to go to the previous page or to exit.
3	Current input signal	7	Status
4	Press OK to enter the menu.		

Likewise, when you wish to switch from the **Advanced** OSD menu to the **Basic** OSD menu, follow the instructions below:

1. Go to **Advanced Menu - System > Menu Settings** and press **OK**.
2. Select **Menu Type** and **OK**.
3. Press **▲/▼** to select **Basic**. Next time when you turn on the projector, you may access the **Basic** OSD menu by pressing ⚙️.

Securing the projector

Using a security cable lock

The projector has to be installed in a safe place to prevent theft. Otherwise, purchase a lock to secure the projector. You can locate a security bar on the bottom side of the projector. See item 19 on [page 9](#).

Utilizing the password function

Setting a password

1. Go to **Advanced Menu - Settings > Security Settings**. Press **OK**. The **Security Settings** page appears.
2. Highlight **Change Password** and press **OK**.
3. The four arrow keys (**▲**, **▶**, **▼**, **◀**) respectively represent 4 digits (1, 2, 3, 4). According to the password you desire to set, press the arrow keys to enter six digits for the password.
4. Confirm the new password by re-entering the new password. Once the password is set, the OSD menu returns to the **Security Settings** page.
5. To activate the **Power On Lock** function, press **▲/▼** to highlight **Power On Lock** and press **◀/▶** to select **On**. Input the password again.

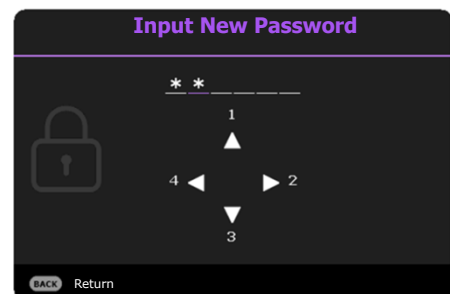



- The digits being input will display as asterisks on-screen. Make a note of your selected password and keep it in a safe place in advance or right after the password is entered so that it is available to you should you ever forget it.
- Once a password has been set and the power on lock is activated, the projector cannot be used unless the correct password is entered every time the projector is started.

If you forget the password

If you enter the wrong password, the password error message will appear, and the **Input Current Password** message follows. If you absolutely do not remember the password, you can use the password recall procedure. See [Entering the password recall procedure on page 77](#).

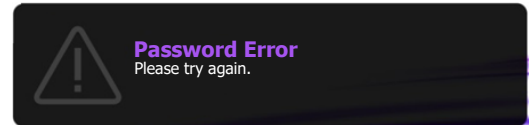

If you enter an incorrect password 5 times in succession, the projector will automatically shut down in a short time.

Entering the password recall procedure

1. Press and hold **AUTO** for 3 seconds. The projector will display a coded number on the screen.
2. Write down the number and turn off your projector.
3. Seek help from the local BenQ service center to decode the number. You may be required to provide proof of purchase documentation to verify that you are an authorized user of the projector.

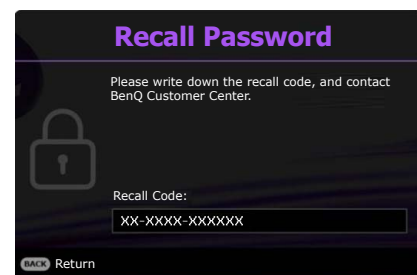

Changing the password

1. Go to **Advanced Menu - Settings > Security Settings > Change Password**.
2. Press **OK**. The message “**Input Current Password**” appears.
3. Enter the old password.
 - If the password is correct, another message “**Input New Password**” appears.
 - If the password is incorrect, the password error message will appear, and the message “**Input Current Password**” appears for your retry. You can press ↵ to cancel the change or try another password.
4. Enter a new password.
5. Confirm the new password by re-entering the new password.

Disabling the password function

To disable password protection, go to **Advanced Menu - Settings > Security Settings > Power On Lock** and press ◀/▶ to select **Off**. The message “**Input Current Password**” appears. Enter the current password.

- If the password is correct, the OSD menu returns to the **Security Settings** page. You will not have to enter the password next time turning on the projector.
- If the password is incorrect, the password error message will appear, and the message “**Input Current Password**” appears for your retry. You can press ↵ to cancel the change or try another password.



Though the password function is disabled, you need to keep the old password in hand should you ever need to re-activate the password function by entering the old password.



Switching input signal

The projector can be connected to multiple devices at the same time. However, it can only display one full screen at a time. When starting up, the projector automatically searches for the available signals.

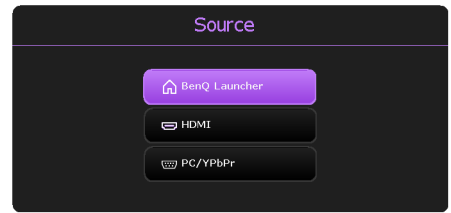
When the **Advanced Menu - Settings > Auto Source Search** menu is **On**, the projector will automatically search for **BenQ Launcher**.



To select the source:

1. Press . A source selection bar appears.
2. Press / until your desired signal is selected and press **OK**.

Once detected, the selected source information will appear at the corner of the screen for seconds. If there is multiple equipment connected to the projector, repeat steps 1-2 to search for another signal.



For best display picture results, you should select and use an input signal which outputs at the projector's native resolution. Any other resolutions will be scaled by the projector depending upon the "aspect ratio" setting, which may cause some image distortion or loss of picture clarity. See [Aspect Ratio on page 84](#).

Menu operation

Please note that the on-screen display (OSD) menus vary according to the signal type selected and the projector model you are using.

The menu items are available when the projector detects at least one valid signal. If there is no equipment connected to the projector or no signal detected, limited menu items are accessible.

Menu System

Basic menu

Main menu	Options
Brightness	0~50~100
Aspect Ratio	Auto/Real/4:3/16:9/16:10
Picture Mode	Bright/Presentation/Infographic/Video/sRGB/ (3D)/User 1/User 2
Volume	0~5~10
Light Mode	Normal/Economic/SmartEco/LampSave
Information	Native Resolution
	Detected Resolution
	Source
	Picture Mode
	Light Mode
	3D Format
	Color System
	Light Usage Time
	Firmware Version
	Service Code
Menu Type	Basic/Advanced

Advanced menu

Main menu	Submenu	Options	
Picture	Picture Mode	Bright/Presentation/Infographic/Video/sRGB/(3D)/User 1/User 2	
	Reference Mode	Bright/Presentation/Infographic/Video/sRGB/(3D)	
	Brightness	0~50~100	
	Contrast	-50~0~50	
	Color	-50~0~50	
	Sharpness	0~15~31	
	Brilliant Color	On/Off	
		Color Temperature	Cool/Normal/Warm
			R Gain (0~50~100)
			G Gain (0~50~100)
		Color Temperature Tuning	B Gain (0~50~100)
			R Offset (-50~0~50)
			G Offset (-50~0~50)
			B Offset (-50~0~50)
		Advanced Color Settings	R (Primary Color/Hue/Saturation/Gain)
			G (Primary Color/Hue/Saturation/Gain)
			B (Primary Color/Hue/Saturation/Gain)
		Color Management	C (Primary Color/Hue/Saturation/Gain)
			M (Primary Color/Hue/Saturation/Gain)
			Y (Primary Color/Hue/Saturation/Gain)
		Wall Color	Off/Light Yellow/Pink/Light Green/Blue/Blackboard
	Reset Picture	Reset/Cancel	

Main menu	Submenu	Options	
Display	Aspect Ratio	Auto/Real/4:3/16:9/16:10	
	Keystone	-40~0~40	
	Test Pattern	On/Off	
	PC & Component YPbPr Tuning	Phase	
		H. Size	
	Position	H : -5~0~5	
		V : -5~0~5	
	3D	3D Mode	Auto/Top Bottom/Frame Sequential/Frame Packing/Side by Side/Off
		3D Sync Invert	Disable/Invert
		Apply 3D Settings	3D Settings 1/3D Settings 2/3D Settings 3/Off
		Save 3D Settings	3D Settings 1/3D Settings 2/3D Settings 3
	HDMI Format	Auto/RGB Limited/RGB Full/YUV Limited/YUV Full	
	Image Resizing	Digital Zoom	1.0X~1.8X/2.0X
		Digital Shrink & Shift	0.75X~1.0X
	Reset Display	Reset/Cancel	

Main menu	Submenu	Options		
Settings	Projector Installation	Front Table/Rear Table/Rear Ceiling/Front Ceiling		
	Remote Receiver	Front/Top/Front+Top		
	Auto Source Search	On/Off		
	Auto Sync	On/Off		
	Light Settings	Light Mode	Normal/Economic/SmartEco/LampSave	
		Reset Light Timer	Reset/Cancel	
		Light Usage Time		
	Operation Settings	Quick Cooling	On/Off	
		Blank Timer	Disable/5 min/10 min/15 min/20 min/25 min/30 min	
		Reminder Message	On/Off	
		High Altitude Mode	On/Off	
		Power On/Off Settings	Direct Power On	
			Signal Power On	
			Auto Power Off	
			Power Off Timer	
		Instant Restart	On/Off	
		Security Settings	Panel Key Lock	On/Off
	Change Password			
	Power On Lock		On/Off	
	Baud Rate		9600/14400/19200/38400/57600/115200	
	HDMI Equalizer	HDMI	Auto/Lower/Low/Middle/High/Higher	
	Reset Settings		Reset/Cancel	

Main menu	Submenu	Options	
System	Language	English/Français/Deutsch/Italiano/Español/ Русский/繁體中文/简体中文/日本語/한국어/ Svenska / Nederlands / Türkçe / Čeština / Português/ไทย/Polски/Magyar/Hrvatski/ Română/Norsk/Dansk/Български/ Suomi/Bhs Ind/Ελληνικά/العربية/हिंदी/ Tiếng Việt/فارسی	
	Standby Settings	Standby Mode	Eco/Normal
		Audio Pass Through	Off/Audio in/HDMI
	Background Settings	Background	BenQ/Black/Blue/Purple
		Splash Screen	BenQ/Black/Blue
	Menu Settings	Menu Type	Basic/Advanced
		Menu Display Time	5 sec/10 sec/20 sec/30 sec/Always
	Audio Settings	Mute	On/Off
		Volume	0~5~10
		Power On/Off Ring Tone	On/Off
	Factory Default	Reset/Cancel	
	Reset System	Reset/Cancel	
	Information	Native Resolution	
		Detected Resolution	
Source			
Picture Mode			
Light Mode			
3D Format			
Color System			
Light Usage Time			
Firmware Version			
Service Code			

Basic menu

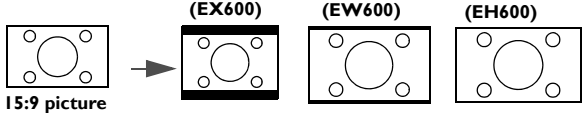
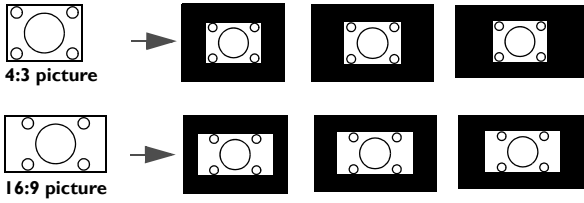
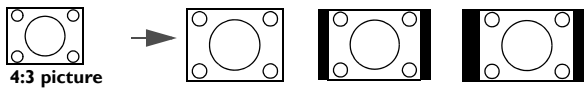
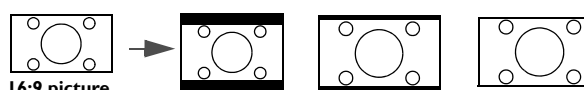
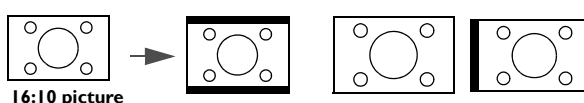
<p>Brightness</p>	<p>The higher the value, the brighter the image. Adjust this control so the black areas of the image appear just as black and that detail in the dark areas is visible.</p>
<p>Aspect Ratio</p>	<p>There are several options to set the image's aspect ratio depending on your input signal source.</p> <ul style="list-style-type: none"> <p>• Auto: Scales an image proportionally to fit the projector's native resolution in its horizontal or vertical width.</p>  <p>• Real: Projects an image as its original resolution and resizes it to fit within the display area. For input signals with lower resolutions, the projected image will be displayed in its original size.</p>  <p>• 4:3: Scales an image so that it is displayed in the center of the screen with a 4:3 aspect ratio.</p>  <p>• 16:9: Scales an image so that it is displayed in the center of the screen with a 16:9 aspect ratio.</p>  <p>• 16:10: Scales an image so that it is displayed in the center of the screen with a 16:10 aspect ratio.</p> 
<p>Picture Mode</p>	<p>The projector is preset with several predefined picture modes so that you can choose one to suit your operating environment and input signal picture type.</p> <ul style="list-style-type: none"> <p>• Bright: Maximizes the brightness of the projected image. This mode is suitable for environments where extra-high brightness is required, such as using the projector in well lit rooms.</p> <p>• Presentation: Is designed for presentations. The brightness is emphasized in this mode to match PC and notebook coloring.</p> <p>• Infographic: Is perfect for presentations with the mixture of text and graphics due to its high color brightness and better color gradation to see the details clearly.</p> <p>• Video: Is suitable for playing videos in an environment where there is ambient light. Dynamic color details are preserved by BenQ enhancement technology.</p> <p>• sRGB: Maximizes the purity of RGB colors to provide true-to-life images regardless of brightness setting. It is most suitable for viewing photos taken with an sRGB compatible and properly calibrated camera, and for viewing PC graphic and drawing applications such as AutoCAD.</p> <p>• 3D: Is appropriate for playing 3D images and 3D video clips.</p> <p>• User 1/User 2: Recalls the settings customized based on the current available picture modes. See Reference Mode on page 86.</p>

Volume	Adjusts the sound level.
Light Mode	See Setting the Light Mode on page 96 .
Information	<ul style="list-style-type: none"> • Native Resolution: Shows the native resolution of the projector. • Detected Resolution: Shows the native resolution of the input signal. • Source: Shows the current signal source. • Picture Mode: Shows the selected mode in the Picture menu. • Light Mode: Shows the selected mode in the Light Settings menu. • 3D Format: Shows the current 3D mode. • Color System: Shows input system format. • Light Usage Time: Shows the number of hours the lamp has been used. • Firmware Version: Shows the firmware version of your projector. • Service Code: Show the projector's serial number.
Menu Type	Switches to the Advanced OSD menu. See Using the projector menus under non-Launcher source on page 75 .

Advanced menu



Picture

Picture Mode	<p>The projector is preset with several predefined picture modes so that you can choose one to suit your operating environment and input signal picture type.</p> <ul style="list-style-type: none">• Bright: Maximizes the brightness of the projected image. This mode is suitable for environments where extra-high brightness is required, such as using the projector in well lit rooms.• Presentation: Is designed for presentations. The brightness is emphasized in this mode to match PC and notebook coloring.• Infographic: Is perfect for presentations with the mixture of text and graphics due to its high color brightness and better color gradation to see the details clearly.• Video: Is suitable for playing videos in an environment where there is ambient light. Dynamic color details are preserved by BenQ enhancement technology.• sRGB: Maximizes the purity of RGB colors to provide true-to-life images regardless of brightness setting. It is most suitable for viewing photos taken with an sRGB compatible and properly calibrated camera, and for viewing PC graphic and drawing applications such as AutoCAD.• 3D: Is appropriate for playing 3D images and 3D video clips.• User 1/User 2: Recalls the settings customized based on the current available picture modes. See Reference Mode on page 86.
Reference Mode	<p>There are 2 user-definable modes if the current available picture modes are not suitable for your need. You can use one of the picture modes (except the User 1/User 2) as a starting point and customize the settings.</p> <ol style="list-style-type: none">1. Go to Picture > Picture Mode.2. Press ◀/▶ to select User 1 or User 2.3. Press ▼ to highlight Reference Mode, and press ◀/▶ to select a picture mode that is closest to your need.4. Press ▼ to select a menu item to be changed and adjust the value. The adjustments define the selected user mode.
Brightness	<p>The higher the value, the brighter the image. Adjust this control so the black areas of the image appear just as black and that detail in the dark areas is visible.</p>
Contrast	<p>The higher the value, the greater the contrast. Use this to set the peak white level after you have previously adjusted the Brightness setting to suit your selected input and viewing environment.</p>
Color	<p>Lower setting produces less saturated colors. If the setting is too high, colors on the image will be overpowering, which makes the image unrealistic.</p>
Sharpness	<p>The higher the value, the sharper the picture becomes.</p>

<p>Brilliant Color</p>	<p>This feature utilizes a new color-processing algorithm and system level enhancements to enable higher brightness while providing truer, more vibrant colors in picture. It enables a greater than 50% brightness increase in mid-tone images, which are common in video and natural scenes, so the projector reproduces images in realistic and true colors. If you prefer images with that quality, select On.</p> <p>When Off is selected, the Color Temperature function is not available.</p>
<p>Advanced Color Settings</p>	<p>Color Temperature</p> <p>There are several preset color temperature settings available. The available settings may vary according to the signal type selected.</p> <ul style="list-style-type: none"> • Normal: Maintains normal colorings for white. • Cool: Makes images appear bluish white. • Warm: Makes images appear reddish white. <p>Color Temperature Tuning</p> <p>You can also set a preferred color temperature by adjusting the following options.</p> <ul style="list-style-type: none"> • R Gain/G Gain/B Gain: Adjusts the contrast levels of Red, Green, and Blue. • R Offset/G Offset/B Offset: Adjusts the brightness levels of Red, Green, and Blue. <p>Color Management</p> <p>This function provides six sets (RGBCMY) of colors to be adjusted. When you select each color, you can independently adjust its range and saturation according to your preference.</p> <ul style="list-style-type: none"> • Primary Color: Selects a color from among R (Red), G (Green), B (Blue), C (Cyan), M (Magenta), or Y (Yellow). • Hue: Hue is used for adjusting the color balance. Increase in the value will include colors consisted of more proportions of its adjacent colors in counterclockwise order. Decrease in the value will have effect in clockwise order. Please refer to the illustration for how the colors relate to each other <div data-bbox="1098 1220 1453 1556" data-label="Diagram"> </div> <p>For example, if you select Red and set its value at 0, only pure red in the projected picture will be selected. Increasing its value will include red close to yellow while decreasing its value will include red close to magenta.</p> <ul style="list-style-type: none"> • Saturation: Adjusts the values to your preference. Every adjustment made will reflect to the image immediately. For example, if you select Red and set its value at 0, only the saturation of pure red will be affected. <p> Saturation is the amount of that color in a video picture. Lower settings produce less saturated colors; a setting of “0” removes that color from the image entirely. If the saturation is too high, that color will be overpowering and unrealistic.</p> <ul style="list-style-type: none"> • Gain: Adjusts the values to your preference. The contrast level of the primary color you select will be affected. Every adjustment made will reflect to the image immediately.

<p>Advanced Color Settings</p>	<p>Wall Color</p> <p>Corrects the projected picture's color when the projection surface such as a painted wall which may not be white, the Wall Color feature can help correct the projected picture's colors to prevent possible color difference between the source and projected pictures. There are several precalibrated colors to choose from: Light Yellow, Pink, Light Green, Blue, and Blackboard.</p>
<p>Reset Picture</p>	<p>Returns all of the adjustments you've made for the Picture menu to the factory preset values.</p>

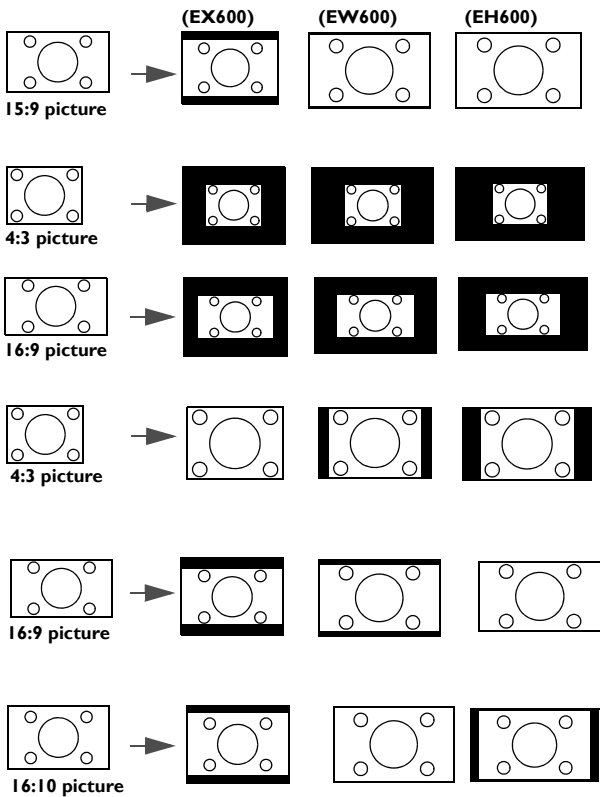
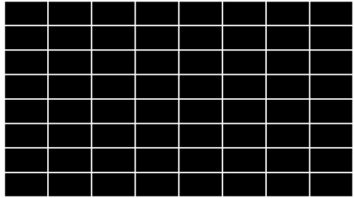
Display

<p>Aspect Ratio</p>	<p>There are several options to set the image's aspect ratio depending on your input signal source.</p> <ul style="list-style-type: none"> • Auto: Scales an image proportionally to fit the projector's native resolution in its horizontal or vertical width. • Real: Projects an image as its original resolution and resizes it to fit within the display area. For input signals with lower resolutions, the projected image will be displayed in its original size. • 4:3: Scales an image so that it is displayed in the center of the screen with a 4:3 aspect ratio. • 16:9: Scales an image so that it is displayed in the center of the screen with a 16:9 aspect ratio. • 16:10: Scales an image so that it is displayed in the center of the screen with a 16:10 aspect ratio. 
<p>Keystone</p>	<p>Corrects any keystone of the image. See Correcting keystone on page 19.</p>
<p>Test Pattern</p>	<p>Adjusts the image size and focus and check that the projected image is free from distortion.</p> 
<p>PC & Component YPbPr Tuning</p>	<ul style="list-style-type: none"> • Phase: Adjusts the clock phase to reduce image distortion. This function is only available when a PC signal (analog RGB) or YPbPr signal is selected. • H. Size: Adjusts the horizontal width of the image. This function is only available when a PC signal (analog RGB) is selected. 







Position	Displays the position adjustment page. To move the projected image, use the directional arrow keys. This function is only available when a PC signal (analog RGB) is selected.
3D	<p>This projector features a 3D function which enables you to enjoy the 3D movies, videos, and sporting events in a more realistic way by presenting the depth of the images. You need to wear a pair of 3D glasses to view the 3D images.</p> <ul style="list-style-type: none"> • 3D Mode: The default setting is Off. If you want the projector to automatically choose an appropriate 3D format when detecting 3D contents, select Auto. If the projector cannot recognize the 3D format, press ▲/▼ to choose a 3D mode from among Top Bottom, Frame Sequential, Frame Packing and Side by Side. <p> When 3D function is activated:</p> <ul style="list-style-type: none"> • The brightness level of the projected image will decrease. • The following settings cannot be adjusted: Picture Mode, Reference Mode. • The Keystone can only be adjusted within limited degrees. • 3D Sync Invert: When you discover the inversion of the image depth, enable this function to correct the problem. • Apply 3D Settings: After the 3D settings are saved, you can decide if you would like to apply them by choosing a set of 3D settings that you have saved. Once applied, the projector will automatically play the incoming 3D contents if it matches the 3D settings saved. <p> Only the set(s) of 3D settings with memorized data is available.</p> <ul style="list-style-type: none"> • Save 3D Settings: When you have successfully displayed the 3D contents after making the appropriate adjustments, you can enable this function and choose a set of 3D settings to memorize current 3D settings.
HDMI Format	<p>Selects a suitable color format to optimize display quality.</p> <ul style="list-style-type: none"> • Auto: Automatically selects a suitable color space and gray level for the incoming HDMI signal. • RGB Limited: Utilizes the Limited range RGB 16-235. • RGB Full: Utilizes the Full range RGB 0-255. • YUV Limited: Utilizes the Limited range YUV 16-235. • YUV Full: Utilizes the Full range YUV 0-255.

Image Resizing	<p>Digital Zoom</p> <p>Magnifies or reduces the projected image size.</p> <ol style="list-style-type: none"> 1. After the adjustment bar displays, press ▲/▼ repeatedly to reduce or magnify the image to a desired size. 2. Press OK to enter panning mode. 3. Press the directional arrows (▲, ▼, ◀, ▶) on the projector or remote control to navigate the picture.  <p>The picture can only be navigated after it is magnified. You can further magnify the picture while searching for details.</p>
	<p>Digital Shrink & Shift</p> <p>Shrinks and/or shifts the projected image.</p> <ol style="list-style-type: none"> 1. After the adjustment bar displays, press ◀/▶ repeatedly to shrink or magnify the picture to a desired size. 2. Press OK to activate digital shift function. 3. After digital shift function is activated, press the directional arrows (▲, ▼, ◀, ▶) to shift the image. 4. Press AUTO to restore the picture to its original size.  <p>The picture can only be shifted after it shrank.</p>
Reset Display	Returns all of the adjustments you've made for the Display menu to the factory preset values.



Settings

Projector Installation	See Choosing a location on page 14 .
Remote Receiver	Allows you to enable all the remote receivers or one specific remote receiver on the projector.
Auto Source Search	Allows the projector to automatically search for a signal.
Auto Sync	<ul style="list-style-type: none"> • On: Allows the projector to automatically determines the best picture timings for the displayed image when PC signal (analog RGB) is selected and AUTO is pressed. • Off: The projector will not respond when AUTO is pressed.
Light Settings	<ul style="list-style-type: none"> • Light Mode: See Setting the Light Mode on page 96. • Reset Light Timer: See Resetting the lamp timer on page 99. • Light Usage Time: Displays the number of hours the lamp has been used.

<p>Operation Settings</p>	<p>Quick Cooling</p> <p>Selecting On enables the function and projector cooling time will be shortened from a normal 90-second duration to approximately 15 seconds.</p>
	<p>Blank Timer</p> <p>Sets the image blank time when there is no action taken on the blank screen, once elapsed the image will return to the screen. If the preset time spans are not suitable for your need, select Disable. No matter Blank Timer is activated or not, you can press most of the keys on the projector or remote control to restore the picture.</p>
	<p>Reminder Message</p> <p>Sets the reminder messages on or off.</p>
	<p>High Altitude Mode</p> <p>We recommend you use the High Altitude Mode when your environment is between 1500 m –3000 m above sea level, and ambient temperature is between 0°C–30°C.</p> <p>Operation under "High Altitude Mode" may cause a higher decibel operating noise level because of increased fan speed necessary to improve overall system cooling and performance.</p> <p>If you use this projector under other extreme conditions excluding the above, it may display auto shut-down symptoms, which is designed to protect your projector from over-heating. In cases like this, you should switch to High Altitude mode to solve these symptoms. However, this is not to state that this projector can operate under any and all harsh or extreme conditions.</p> <p></p> <p>Do not use the High Altitude Mode if your altitude is between 0 m and 1500 m and ambient temperature is between 0°C and 35°C. The projector will be over cooled, if you turn the mode on under such a condition.</p>
	<p>Power On/Off Settings</p> <ul style="list-style-type: none"> • Direct Power On: Allows the projector to turn on automatically once the power is fed through the power cord. • Signal Power On: Sets whether to turn the projector directly on without pressing  POWER or  ON when the projector is in standby mode and detects a VGA signal or a HDMI signal with 5V power. • Auto Power Off: Allows the projector to turn off automatically if no input signal is detected after a set period of time to prevent unnecessary waste of lamp life. • Power Off Timer: Sets the auto-shutdown timer.
	<p>Instant Restart</p> <p>Allows you to restart the projector immediately within 90 seconds after turning it off.</p>
<p>Security Settings</p>	<p>See Utilizing the password function on page 76.</p>

Baud Rate	Selects a baud rate that is identical with your computer's so that you can connect the projector using a suitable RS-232 cable and update or download the projector's firmware. This function is intended for qualified service personnel.
HDMI Equalizer	Adjusts the equalizer gain settings for an HDMI signal. The higher the setting, the stronger the gain value. If there are more than one HDMI port on the projector, select the HDMI port first before adjusting the value.
Reset Settings	Returns all of the adjustments you've made for the Settings menu to the factory preset values.





System

Language	Sets the language for the On-Screen Display (OSD) menus.
Standby Settings	<ul style="list-style-type: none"> • Standby Mode <ul style="list-style-type: none"> • Eco: The projector maintains at normal standby mode with less than 0.5W power consumption. • Normal: Allows the projector to provide audio pass through function in standby mode. • Audio Pass Through: The projector can play sound when it is in standby mode and the corresponding jacks are correctly connected to devices. Press ◀/▶ to choose the source that you wish to use. See Connection on page 20 for how to make the connection.
Background Settings	<ul style="list-style-type: none"> • Background: Sets the background color for the projector. • Splash Screen: Allows you to select which logo screen will be displayed during projector start-up.
Menu Settings	<ul style="list-style-type: none"> • Menu Type: Switches to the Basic OSD menu. • Menu Display Time: Sets the length of time the OSD will remain active after your last key press.
Audio Settings	<ul style="list-style-type: none"> • Mute: Temporarily turns off the sound. • Volume: Adjusts the sound level. • Power On/Off Ring Tone: Turns on or off the ring tone when the projector is in startup and shutdown process.  <p>The only way to change Power On/Off Ring Tone is setting On or Off here. Setting the sound mute or changing the sound level will not affect the Power On/Off Ring Tone.</p>
Factory Default	<p>Returns all settings to the factory preset values.</p>  <p>The following settings will still remain: Keystone, Projector Installation, Light Usage Time, High Altitude Mode, Security Settings, Baud Rate, HDMI Equalizer.</p>
Reset System	Returns all of the adjustments you've made for the System menu to the factory preset values.

Information

Information	<ul style="list-style-type: none">• Native Resolution: Shows the native resolution of the projector.• Detected Resolution: Shows the native resolution of the input signal.• Source: Shows the current signal source.• Picture Mode: Shows the selected mode in the Picture menu.• Light Mode: Shows the selected mode in the Light Settings menu.• 3D Format: Shows the current 3D mode.• Color System: Shows input system format.• Light Usage Time: Shows the number of hours the lamp has been used.• Firmware Version: Shows the firmware version of your projector.• Service Code: Shows the projector serial number.
--------------------	--

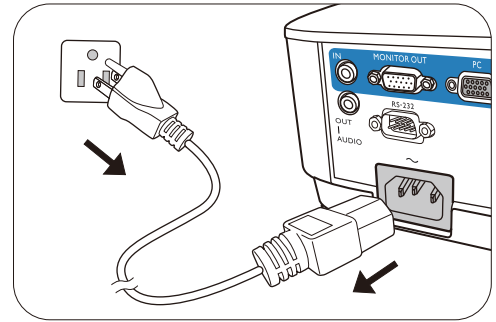

Shutting down the projector

1. Press  on the projector or  on the remote control and a confirmation message will appear prompting you. If you don't respond in a few seconds, the message will disappear.
2. Press  or  a second time. The power indicator flashes orange, the projection lamp shuts down, and the fans will continue to run for approximately 90 seconds to cool down the projector.
3. Once the cooling process finishes, the power indicator becomes a steady orange and fans stop. Disconnect the power cord from the power outlet.



- To protect the lamp, the projector will not respond to any commands during the cooling process.
- To shorten the cooling time, you can also activate the Quick cooling function. See [Quick Cooling on page 91](#).
- Avoid turning on the projector immediately after turning it off as excessive heat may shorten lamp life.
- Lamp life results will vary depending on environmental conditions and usage.

Direct power off

The AC power cord can be pulled out right after the projector is turned off. To protect the lamp, wait about 10 minutes before re-starting the projector. If you attempt to re-start the projector, the fans may run for a few minutes to cool down. In such cases, press  or  again to start the projector after the fans stop and the power indicator turns orange.

Maintenance

Care of the projector

Cleaning the lens

Clean the lens whenever you notice dirt or dust on the surface. Please be sure to turn off the projector and let it cool down completely before cleaning the lens.

- Use a canister of compressed air to remove dust.
- If there is dirt or smears, use lens-cleaning paper or moisten a soft cloth with lens cleaner and gently wipe the lens surface.
- Never use any type of abrasive pad, alkaline/acid cleaner, scouring powder, or volatile solvent, such as alcohol, benzene, thinner or insecticide. Using such materials or maintaining prolonged contact with rubber or vinyl materials may result in damage to the projector surface and cabinet material.

Cleaning the projector case

Before you clean the case, turn the projector off using the proper shutdown procedure as described in [Menu operation on page 79](#) and unplug the power cord.

- To remove dirt or dust, wipe the case with a soft, lint-free cloth.
- To remove stubborn dirt or stains, moisten a soft cloth with water and a neutral pH detergent. Then wipe the case.



Never use wax, alcohol, benzene, thinner or other chemical detergents. These can damage the case.

Storing the projector

If you need to store the projector for an extended time, please follow the instructions below:

- Make sure the temperature and humidity of the storage area are within the recommended range for the projector. Please refer to [Specifications on page 102](#) or consult your dealer about the range.
- Retract the adjuster feet.
- Remove the battery from the remote control.
- Pack the projector in its original packing or equivalent.

Transporting the projector

It is recommended that you ship the projector with its original packing or equivalent.

Light information

Getting to know the light hour

When the projector is in operation, the duration (in hours) of light usage is automatically calculated by the built-in timer. The method of calculating the equivalent lamp hour is as follows:

I. **Light Usage Time** = (x+y+z+a) hours, if:

Time used in **Normal** mode = x hours

Time used in **Economic** mode = y hours

Time used in **SmartEco** mode = z hours

Time used in **LampSave** mode = a hours

2. Equivalent light source hour = α hours

$$\alpha = x(A'/X) + y(A'/Y) + z(A'/Z) + a(A'/A), \text{ if}$$

X= lamp life spec of **Normal** mode

Y= lamp life spec of **Economic** mode

Z= lamp life spec of **SmartEco** mode

A= lamp life spec of **LampSave** mode

A' is the longest lamp life spec among X, Y, Z, A



When you calculate Equivalent Lamp hour manually, it will probably have deviation from the value shown in OSD menu since projector system calculates time used for each lamp mode in “Minutes” then rounds down to an integer in hours shown in OSD.



For time used in each lamp mode shown in OSD menu:

- Time used is accumulated and rounded down to an integer in **hours**.
- When time used is less than 1 hour, it shows 0 hours.

To obtain the lamp hour information:

1. Go to **Advanced Menu - Settings > Light Settings** and press **OK**. The **Light Settings** page appears.
2. Press **▼** to select **Light Usage Time** and press **OK**. The **Light Usage Time** information is displayed.

You can also get the lamp hour information on the **Information** menu.

Extending lamp life

- Setting the **Light Mode**

Go to **Advanced Menu - Settings > Light Settings > Light Mode** and select a suitable lamp power from among the provided modes.

Setting the projector in **Economic**, **SmartEco** or **LampSave** mode extends lamp life.

Lamp mode	Description
Normal	Provides full lamp brightness
Economic	Lowers brightness to extend the lamp life and decreases the fan noise
SmartEco	Adjusts the lamp power automatically depending on the content brightness level while optimizing display quality
LampSave	Adjusts the lamp power automatically depending on the content brightness level while offering a longer lamp life

- Setting **Auto Power Off**

This function allows the projector to turn off automatically if no input signal is detected after a set period of time to prevent unnecessary waste of lamp life.

To set **Auto Power Off**, go to **Advanced Menu - Settings > Operation Settings > Power On/Off Settings > Auto Power Off** and press **◀/▶**.

Timing of replacing the lamp

When the **Lamp indicator** lights up or a message appears suggesting it is time to replace the lamp, please consult your dealer or go to <http://www.BenQ.com> before installing a new lamp. An old lamp may cause a malfunction in the projector and in some instances the lamp may explode.



- The apparent brightness of the projected image will vary depending on the ambient lighting conditions, selected input signal contrast/brightness settings, and is directly proportional to projection distance.
- The lamp brightness will decline over time and may vary within the lamp manufacturers specifications. This is normal and expected behavior.
- The **LAMP indicator light** and **TEMPerature warning light** will light up if the lamp becomes too hot. Turn the power off and let the projector cool for 45 minutes. If the Lamp or Temp indicator still lights up after turning the power back on, please contact your dealer. See [Indicators on page 100](#).

The following Lamp warning displays will remind you to change the lamp.

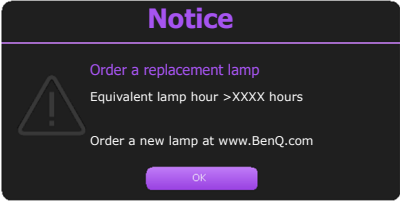
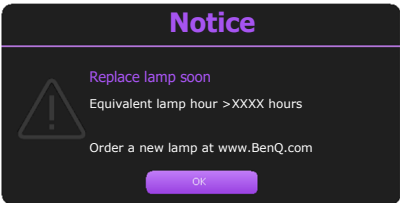
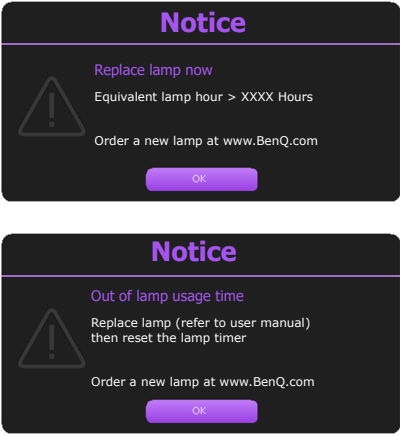
	<p>Install a new lamp for optimal performance. Press OK to dismiss the message.</p>
	<p>It is strongly recommended that you replace the lamp at this age. The lamp is a consumable item. The lamp brightness diminishes with use. This is normal lamp behavior. You can replace the lamp whenever you notice that the brightness level has significantly diminished. Press OK to dismiss the message.</p>
	<p>The lamp MUST be replaced before the projector will operate normally. Press OK to dismiss the message.</p>



"XXXX" shown in the above messages are numbers that vary depending on different models.

Replacing the lamp (FOR SERVICE PERSONNEL ONLY)



- To reduce the risk of electrical shock, always turn the projector off and disconnect the power cord before changing the lamp.
- To reduce the risk of severe burns, allow the projector to cool for at least 45 minutes before replacing the lamp.
- To reduce the risk of injuries to fingers and damage to internal components, use caution when removing lamp glass that has shattered into sharp pieces.
- To reduce the risk of injuries to fingers and/or compromising image quality by touching the lens, do not touch the empty lamp compartment when the lamp is removed.
- This lamp contains mercury. Consult your local hazardous waste regulations to dispose of this lamp in a proper manner.
- To assure optimal performance from the projector, it is recommended that you purchase a qualified projector lamp for lamp replacement.
- If lamp replacement is performed while the projector is suspended upside-down, make sure that no one is underneath the lamp socket to avoid any possible injury or damage to the human eyes caused by fractured lamp.
- Ensure good ventilation when handling broken lamps. We recommend that you use respirators, safety glasses, goggles or face shield and wear protective clothing such as gloves.

1. Turn the power off and disconnect the projector from the power outlet. If the lamp is hot, avoid burns by waiting for approximately 45 minutes until the lamp has cooled.
2. Loosen the screw(s) that secure the lamp cover on the side of the projector until the lamp cover loosens.

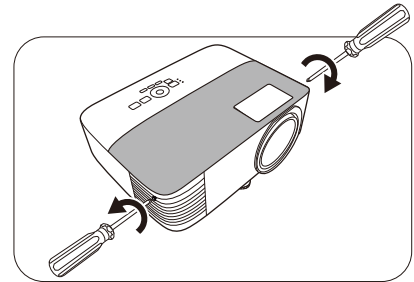

3. Remove the lamp cover from the projector.



- Do not turn the power on with the lamp cover open.
- Do not insert your fingers between the lamp and the projector. The sharp edges inside the projector may cause injuries

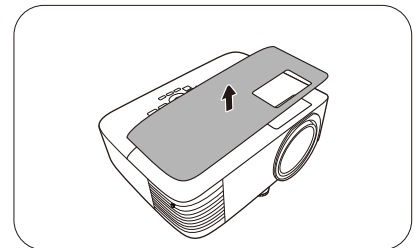

4. Disconnect the lamp connector.
5. Loosen the screw(s) that secure the inner lamp.
6. Lift the handle so that it stands up.

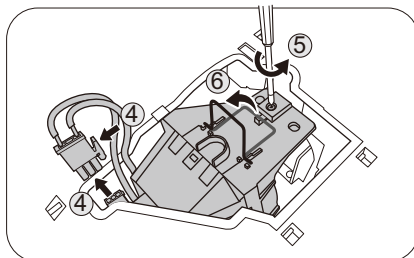

7. Use the handle to slowly pull the lamp out of the projector.

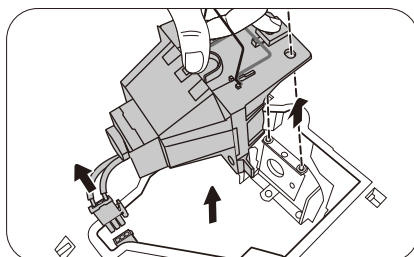



- Pulling it too quickly may cause the lamp to break and scatter broken glass in the projector.
- Do not place the lamp in locations where water might splash on it, children can reach it, or near flammable materials.
- Do not insert your hands into the projector after the lamp is removed. The sharp edges inside the projector may cause injuries. If you touch the optical components inside, it could cause color unevenness and distortion of the projected images.

8. As shown in the figure, insert the new lamp. Align the lamp connector and 2 sharp points with the projector and push the lamp a bit into the locked position.

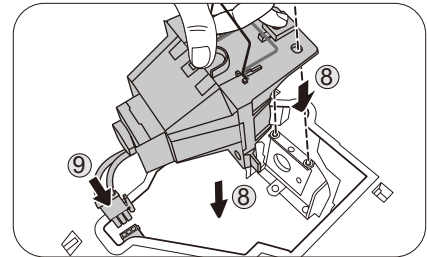

9. Insert the lamp connector.

10. Tighten the screw(s) that secures the lamp.

11. Ensure the handle is fully laid flat and locked in place.



- Loose screw may cause a bad connection, which could result in malfunction.
- Do not over tighten the screw.

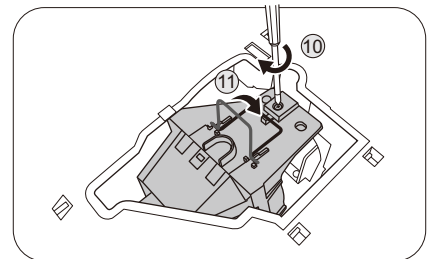

12. Replace the lamp cover on the projector.

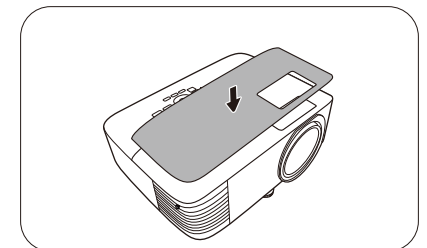

13. Tighten the screw that secures the lamp cover.



- Loose screw may cause a bad connection, which could result in malfunction.
- Do not over tighten the screw.

14. .Connect the power and restart the projector.

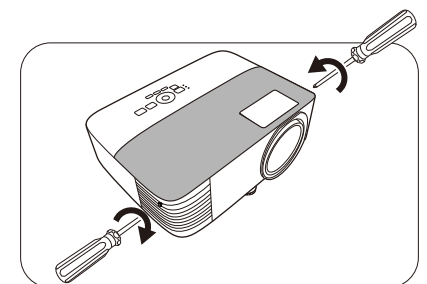







































Resetting the lamp timer









15. After the startup logo, open the On-Screen Display (OSD) menu. Go to **Advanced Menu - Settings > Lamp Settings** and press **OK**. The **Lamp Settings** page appears. Highlight **Reset Lamp Timer** and press **OK**. A warning message is displayed asking if you want to reset the lamp timer. Highlight **Reset** and press **OK**. The lamp time will be reset to “0”.



Do not reset if the lamp is not new or replaced as this could cause damage.

Indicators

Light			Status & Description
POWER ○	TEMP ○	LIGHT ○	
Power events			
			Stand-by mode
			Powering up
			Normal operation
			Normal power-down cooling
			Download
			CW start fail
Lamp events			
			Lamp error in normal operation
			Lamp is not lit up
			Lamp life exhausted
			Lamp door is not closed
Thermal events			
			Fan 1 error (the actual fan speed is outside the desired speed)
			Fan 2 error (the actual fan speed is outside the desired speed)
			Temperature 1 error (over limited temperature)

	 : Off	 : Orange On	 : Green On	 : Red On
		 : Orange Flashing	 : Green Flashing	 : Red Flashing

Troubleshooting

? The projector does not turn on.

Cause	Remedy
There is no power from the power cord.	Plug the power cord into the AC power jack on the projector, and plug the power cord into the power outlet. If the power outlet has a switch, make sure that it is switched on.
Attempting to turn the projector on again during the cooling process.	Wait until the cooling down process has completed.

? No picture

Cause	Remedy
The video source is not turned on or connected correctly.	Turn the video source on and check that the signal cable is connected correctly.
The projector is not correctly connected to the input signal device.	Check the connection.
The input signal has not been correctly selected.	Select the correct input signal with the SOURCE key.
The lens cover is still closed.	Open the lens cover.

? Blurred image

Cause	Remedy
The projection lens is not correctly focused.	Adjust the focus of the lens using the focus ring.
The projector and the screen are not aligned properly.	Adjust the projection angle and direction as well as the height of the projector if necessary.
The lens cover is still closed.	Open the lens cover.

? Remote control does not work.

Cause	Remedy
The batteries are out of power.	Replace both of the batteries with new ones.
There is an obstacle between the remote control and the projector.	Remove the obstacle.
You are too far away from the projector.	Stand within 8 meters (26 feet) of the projector.

? The password is incorrect.

Cause	Remedy
You do not remember the password.	See Entering the password recall procedure on page 77 .

Specifications

Projector specifications



All specifications are subject to change without notice.

Optical

Resolution

EX600: 1024 x 768 XGA

EW600: 1280 x 800 WXGA

EH600: 1920 x 1080 1080p

Display system

1-CHIP DMD

Lens

F = 2.56 ~ 2.68, f = 22 ~ 24.1 mm

Clear focus range

EX600:

2.38–7.15 m @ Wide,

2.62–7.87 m @ Tele

EW600:

2–6 m @ Wide, 2.2–6.6 m @ Tele

EH600:

1.98–5.94 m @ Wide,

2.18–6.53 m @ Tele

Lamp

200 W lamp

Electrical

Power supply

AC100–240V, 50–60 Hz (Automatic)

Power consumption

320 W (Max); < 0.5 W (Standby)

Mechanical

Weight

2.5 Kg (5.5 lbs)

Output terminals

RGB output

D-Sub 15-pin (female) x 1

Speaker

2 watt x 1

Audio signal output

PC audio jack x 1

Control

USB

Type-A: 1A

Type-A: 1.5A

Type-A for wireless dongle: 1.5A

Mini-B x 1

RS-232 serial control

9 pin x 1

IR receiver x 2

Input terminals

Computer input

RGB input

D-Sub 15-pin (female) x 1

Video signal input

SD/HDTV signal input

Analog - Component

(through RGB input)

Digital - HDMI x 1

Audio signal input

Audio in

PC audio jack x 1

Environmental Requirements

Operating temperature

0°C–40°C at sea level

Operating relative humidity

10%–90% (without condensation)

Operating altitude

0–1499 m at 0°C–35°C

1500–3000 m at 0°C–30°C (with

High Altitude Mode on)

Storage temperature

-20°C–60°C at sea level

Storage humidity

10%–90% RH (without condensation)

Storage altitude

30°C@ 0~12,200m above sea level

Transporting

Original packing or equivalent is recommended

Repairing

Please visit below website and choose your country to find your service contact window.

<https://www.benq.com/en-us/business/welcome>

Dimensions

296 mm (W) x 120 mm (H) x 232 mm (D)

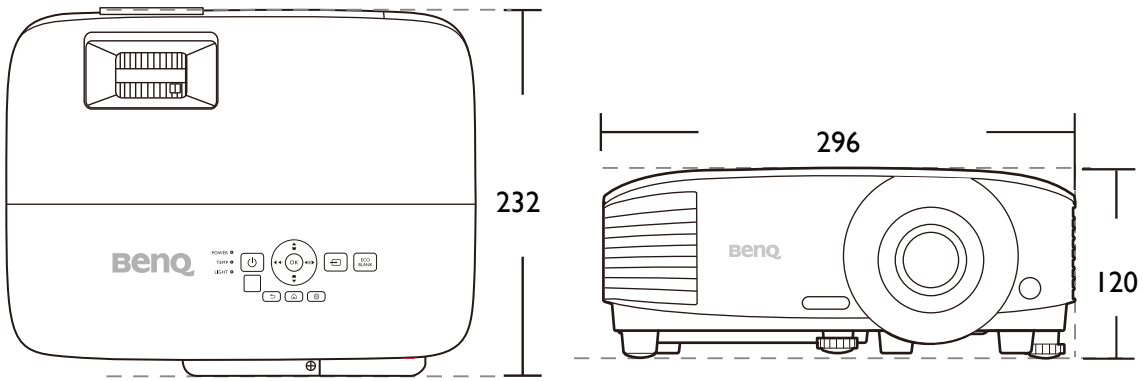

Unit: mm

Timing chart

Supported timing for PC input

Resolution	Mode	Vertical Frequency (Hz)	Horizontal Frequency (kHz)	Pixel Frequency (MHz)	3D format		
					Frame Sequential	Top Bottom	Side by Side
640 x 480	VGA_60	59.940	31.469	25.175	Supported	Supported	Supported
	VGA_72	72.809	37.861	31.500			
	VGA_75	75.000	37.500	31.500			
	VGA_85	85.008	43.269	36.000			
720 x 400	720 x 400_70	70.087	31.469	28.3221			
800 x 600	SVGA_60	60.317	37.879	40.000	Supported	Supported	Supported
	SVGA_72	72.188	48.077	50.000			
	SVGA_75	75.000	46.875	49.500			
	SVGA_85	85.061	53.674	56.250			
	SVGA_120 (Reduce Blanking)	119.854	77.425	83.000	Supported		
1024 x 768	XGA_60	60.004	48.363	65.000	Supported	Supported	Supported
	XGA_70	70.069	56.476	75.000			
	XGA_75	75.029	60.023	78.750			
	XGA_85	84.997	68.667	94.500			
	XGA_120 (Reduce Blanking)	119.989	97.551	115.5	Supported		
1152 x 864	1152 x 864_75	75	67.5	108			
1024 x 576	BenQ Notebook_timing	60.0	35.820	46.966			
1024 x 600	BenQ Notebook_timing	64.995	41.467	51.419			
1280 x 720	1280 x 720_60	60	45.000	74.250	Supported	Supported	Supported
1280 x 768	1280 x 768_60	59.87	47.776	79.5	Supported	Supported	Supported
1280 x 800	WXGA_60	59.810	49.702	83.500	Supported	Supported	Supported
	WXGA_75	74.934	62.795	106.500			
	WXGA_85	84.880	71.554	122.500			
	WXGA_120 (Reduce Blanking)	119.909	101.563	146.25	Supported		
1280 x 1024	SXGA_60	60.020	63.981	108.000		Supported	Supported
	SXGA_75	75.025	79.976	135.000			
	SXGA_85	85.024	91.146	157.500			
1280 x 960	1280 x 960_60	60.000	60.000	108.000		Supported	Supported
	1280 x 960_85	85.002	85.938	148.500			
1360 x 768	1360 x 768_60	60.015	47.712	85.5		Supported	Supported
1440 x 900	WXGA+_60	59.887	55.935	106.500		Supported	Supported
1400 x 1050	SXGA+_60	59.978	65.317	121.750		Supported	Supported
1600 x 1200	UXGA	60.000	75.000	162.000		Supported	Supported
1680 x 1050	1680 x 1050_60	59.954	65.290	146.250		Supported	Supported
640 x 480@67Hz	MAC13	66.667	35.000	30.240			
832 x 624@75Hz	MAC16	74.546	49.722	57.280			
1024 x 768@75Hz	MAC19	74.93	60.241	80.000			
1152 x 870@75Hz	MAC21	75.060	68.680	100.000			



The timings showing above may not be supported due to EDID file and VGA graphic card limitations. It is possible that some timings cannot be chosen.

Supported timing for HDMI (HDCP) input

- PC timings

Resolution	Mode	Vertical Frequency (Hz)	Horizontal Frequency (kHz)	Pixel Frequency (MHz)	3D format		
					Frame Sequential	Top Bottom	Side by Side
640 x 480	VGA_60	59.940	31.469	25.175	Supported	Supported	Supported
	VGA_72	72.809	37.861	31.500			
	VGA_75	75.000	37.500	31.500			
	VGA_85	85.008	43.269	36.000			
720 x 400	720 x 400_70	70.087	31.469	28.3221			
800 x 600	SVGA_60	60.317	37.879	40.000	Supported	Supported	Supported
	SVGA_72	72.188	48.077	50.000			
	SVGA_75	75.000	46.875	49.500			
	SVGA_85	85.061	53.674	56.250			
1024 x 768	SVGA_120 (Reduce Blanking)	119.854	77.425	83.000	Supported		
	XGA_60	60.004	48.363	65.000	Supported	Supported	Supported
	XGA_70	70.069	56.476	75.000			
	XGA_75	75.029	60.023	78.750			
1152 x 864	XGA_85	84.997	68.667	94.500			
	XGA_120 (Reduce Blanking)	119.989	97.551	115.5	Supported		
1152 x 864	1152 x 864_75	75	67.5	108			
1024 x 576@60Hz	BenQ Notebook Timing	60.00	35.820	46.996			
1024 x 600@65Hz	BenQ Notebook Timing	64.995	41.467	51.419			
1280 x 720	1280 x 720_60	60	45.000	74.250	Supported	Supported	Supported
1280 x 768	1280 x 768_60	59.870	47.776	79.5	Supported	Supported	Supported
1280 x 800	WXGA_60	59.810	49.702	83.500	Supported	Supported	Supported
	WXGA_75	74.934	62.795	106.500			
	WXGA_85	84.880	71.554	122.500			
	WXGA_120 (Reduce Blanking)	119.909	101.563	146.25	Supported		
1280 x 1024	SXGA_60	60.020	63.981	108.000		Supported	Supported
	SXGA_75	75.025	79.976	135.000			
	SXGA_85	85.024	91.146	157.500			
1280 x 960	1280 x 960_60	60.000	60.000	108		Supported	Supported
	1280 x 960_85	85.002	85.938	148.500			
1360 x 768	1360 x 768_60	60.015	47.712	85.500		Supported	Supported
1440 x 900	WXGA+_60	59.887	55.935	106.500		Supported	Supported
1400 x 1050	SXGA+_60	59.978	65.317	121.750		Supported	Supported
1600 x 1200	UXGA	60.000	75.000	162.000		Supported	Supported
1680 x 1050	1680 x 1050_60	59.954	65.290	146.250		Supported	Supported
640 x 480@67Hz	MAC13	66.667	35.000	30.240			
832 x 624@75Hz	MAC16	74.546	49.722	57.280			
1024 x 768@75Hz	MAC19	75.020	60.241	80.000			
1152 x 870@75Hz	MAC21	75.06	68.68	100.00			
1920 x 1080@60Hz	1920 x 1080_60	60	67.5	148.5		Supported	Supported
1920 x 1200	1920 x 1200_60 (Reduce Blanking)	59.950	74.038	154.0000		Supported	Supported



The timings showing above may not be supported due to EDID file and VGA graphic card limitations. It is possible that some timings cannot be chosen.

• Video timings

Timing	Resolution	Vertical Frequency (Hz)	Horizontal Frequency (kHz)	Pixel Frequency (MHz)	3D format			
					Frame Sequential	Frame Packing	Top Bottom	Side by Side
480i	720 x 480	59.94	15.73	27	Supported			
480p	720 x 480	59.94	31.47	27	Supported			
576i	720 x 576	50	15.63	27				
576p	720 x 576	50	31.25	27				
720/50p	1280 x 720	50	37.5	74.25		Supported	Supported	Supported
720/60p	1280 x 720	60	45.00	74.25	Supported	Supported	Supported	Supported
1080/50i	1920 x 1080	50	28.13	74.25				Supported
1080/60i	1920 x 1080	60	33.75	74.25				Supported
1080/24P	1920 x 1080	24	27	74.25		Supported	Supported	Supported
1080/25P	1920 x 1080	25	28.13	74.25				
1080/30P	1920 x 1080	30	33.75	74.25				
1080/50P	1920 x 1080	50	56.25	148.5			Supported	Supported
1080/60P	1920 x 1080	60	67.5	148.5			Supported	Supported

Supported timing for Component-YPbPr input

Timing	Resolution	Vertical Frequency (Hz)	Horizontal Frequency (kHz)	Pixel Frequency (MHz)	3D format
					Frame Sequential
480i	720 x 480	59.94	15.73	13.5	Supported
480p	720 x 480	59.94	31.47	27	Supported
576i	720 x 576	50	15.63	13.5	
576p	720 x 576	50	31.25	27	
720/50p	1280 x 720	50	37.5	74.25	
720/60p	1280 x 720	60	45.00	74.25	Supported
1080/50i	1920 x 1080	50	28.13	74.25	
1080/60i	1920 x 1080	60	33.75	74.25	
1080/24P	1920 x 1080	24	27	74.25	
1080/25P	1920 x 1080	25	28.13	74.25	
1080/30P	1920 x 1080	30	33.75	74.25	
1080/50P	1920 x 1080	50	56.25	148.5	
1080/60P	1920 x 1080	60	67.5	148.5	



Displaying a 1080i(1125i)@60Hz or 1080i(1125i)@50Hz signal may result in slight image vibration.

Appendix: Operation (under Launcher source) for firmware version before v01.00.19.00

BenQ Launcher

BenQ Launcher is the projector's operating system that allows you to wirelessly cast your device's screen, play files, run apps, as well as adjust projector settings.

 Use the remote control or connect a USB mouse to the projector's **USB-1** or **USB-2** ports to navigate **BenQ Launcher** and operate its functions.

The BenQ Launcher home screen

Upon initial start up or when **BenQ Launcher** is selected in the input source menu, the projector will display **BenQ Launcher**. If the projector is projecting from an input source (e.g. **HDMI** or **PC**), you can return to **BenQ Launcher** mode by pressing the source button  or the **LAUNCHER** button on the remote control and then selecting **BenQ Launcher** in the input source menu.

 When the **Auto Source Search** function is enabled in the **Advanced > Settings** menu of the projector's OSD menu, the projector will display the **BenQ Launcher** home screen by default every time it is powered on. If the **Auto Source Search** function is disabled, the projector will detect if a signal is available from the input source that was last used and switch to that input source if it is available, if a signal is not available or the projector was set to **BenQ Launcher** during the previous session, the projector will enter the **BenQ Launcher** home screen. See [Settings on page 90](#).

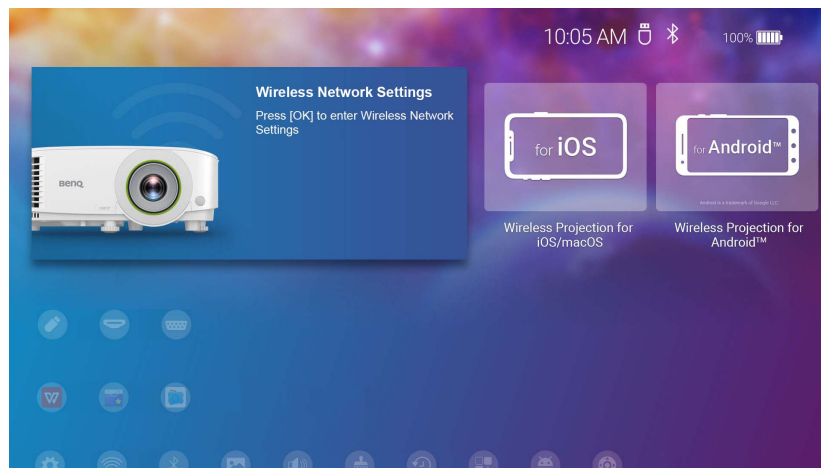

 Actual screen may vary based on your **BenQ Launcher** firmware version.

The **BenQ Launcher** home screen features five main sections:

- Status Bar icons - Icons that display the time, Bluetooth, and wireless status.
- Wireless Projection buttons - Provides instructions on how to project wirelessly via iOS/Android devices or a laptop/PC.
- **Source** menu - Allows you to select open media files from storage devices connected to the **USB-1** or **USB-2** ports, or video input source connected to the **HDMI** or **PC** ports for projection.

- App Shortcuts - Quick access to the pre-installed **File Manager**, **BenQ Suggests**, along with other installed apps.
- **Settings** menus - Shortcuts to the settings menus to adjust wireless network, Bluetooth and other settings.



Press the down button ▼ to access the **Source** menu, App shortcuts, and **Settings** menus.

Navigating the **BenQ Launcher** home screen

1. From the **BenQ Launcher** home screen, press ▲/▼/◀/▶ to select the desired function and press **OK**.
2. Follow on-screen instructions for further operations.

Using the source menu

Press the down button ▼ from the **BenQ Launcher** home screen to access the **Source** menu, which displays the input source options: **USB**, **HDMI**, and **PC**. Press **OK** to select the desired input source. See [Connection on page 20](#) for more information.

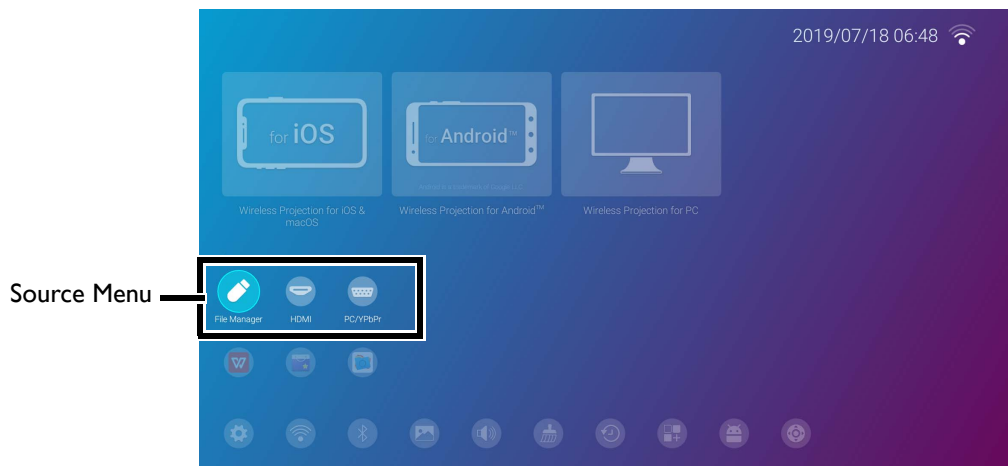

You may also press the source button  from any screen within **BenQ Launcher** to access the **Source** menu.

Using the app menu

Press the down button ▼ twice from the **BenQ Launcher** home screen to access the app shortcuts menu, which displays the pre-installed **BenQ Suggests**, and **File Manager** apps as well as other apps that have been installed on the projector.

To access all the apps installed on the projector, see [All Apps on page 134](#). For details on how to re-order the shortcuts see [Screen Settings on page 138](#).

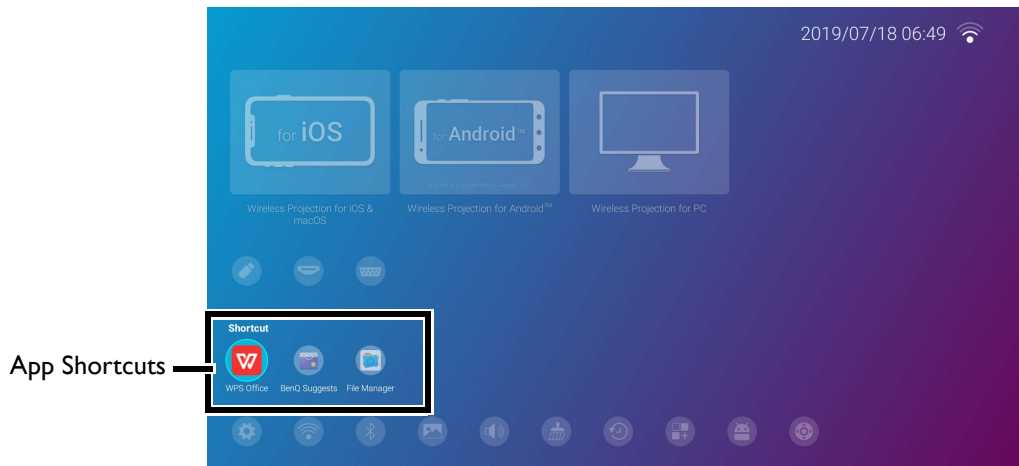

Using the **BenQ Launcher Settings** menus

Press the down button ▼ three times from the **BenQ Launcher** home screen to access the settings menu section, which features a button for the projector's full settings menu as well as shortcut buttons for various sub-menus within the settings menus.



 Actual screen may vary based on your **BenQ Launcher** firmware version.

For more information on the settings menu see [About the Settings menu on page 129](#).

Inputting text

Various menus within **BenQ Launcher** may require that you input text. You may either connect a keyboard to the **USB-I** port at the rear of the projector or follow the steps below:

1. Select the text field where you want to input text.
2. Press **OK** and a full alphanumeric keyboard will appear on screen.
3. Press ▲/▼/◀/▶ to navigate the keyboard, and press **OK** to select the letter/key/symbol you want to enter into the text field.

4. Press the back button  at anytime to exit out of the keyboard.

 Actual keyboard types may vary based on your language preference setting. See [Keyboard on page 140](#) for more information.

Switching to **BenQ Launcher** from an input source

When **HDMI** or **PC** is selected in the source menu, the projector will exit the **BenQ Launcher** interface to project video from the input source (e.g. a Blu-Ray/DVD player, set-top box, or PC). The projector will remain outside of the **BenQ Launcher** interface as long as the **HDMI** or **PC** input source is selected or (depending on **Auto Source Search** settings) until the projector is powered off and back on again.

As a result, anytime the user wants to wirelessly cast their device's screen, view media files stored on a flash drive, or run apps, they must return to the **BenQ Launcher** interface. To return to **BenQ Launcher**:

1. Press the source button  or the **LAUNCHER** button on the remote control.
2. Select **BenQ Launcher** in the source menu.

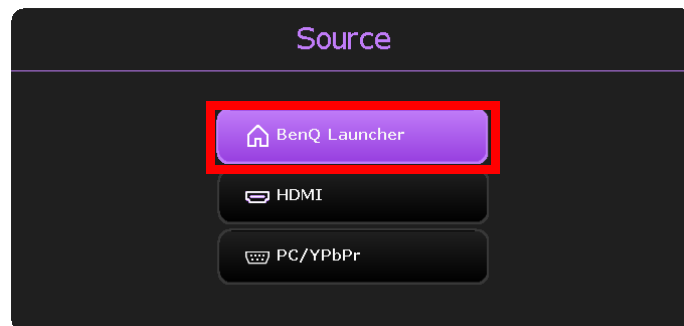

 When the **Auto Source Search** function is enabled in the **Advanced > Settings** menu of the projector's OSD menu, the projector will display the **BenQ Launcher** home screen by default once it is powered on. If the **Auto Source Search** function is disabled, the projector will detect if a signal is available from the input source that was last used and switch to that input source if it is available, if a signal is not available or the projector was set to **BenQ Launcher** during the previous session, the projector will enter the **BenQ Launcher** home screen. See [Settings on page 90](#).

Wireless Connections

Connecting the projector to a wireless network

Before you can project wirelessly via the projector, you must first connect the projector to a wireless network. To connect your projector to a wireless network, or to switch wireless networks:

 If you have already connected the projector to a wireless network during the setup wizard you may skip the steps in this section.

1. Install the provided wireless dongle into the wireless dongle port (see [Installing the wireless dongle on page 8](#)).
2. Power on the projector (see [Starting up the projector on page 22](#)).

3. On the home screen of the BenQ Launcher interface, select **Wireless Network Settings** and press **OK** to access the wireless settings menu.

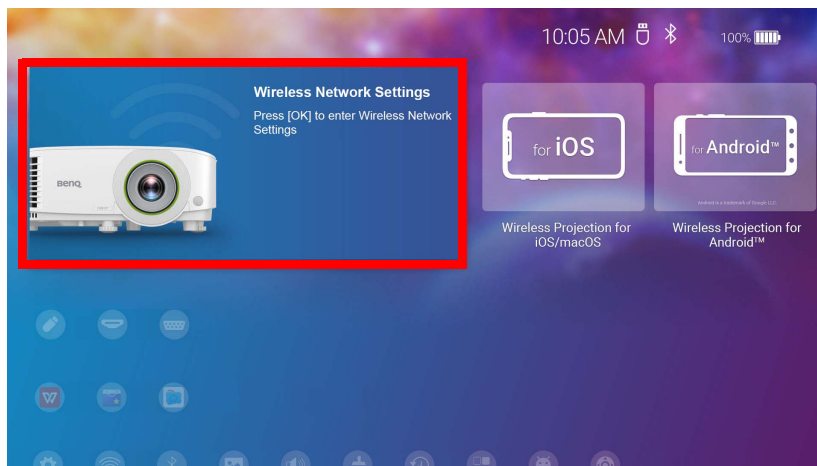

4. Select **Wireless Network Settings** and press **OK** to enable.

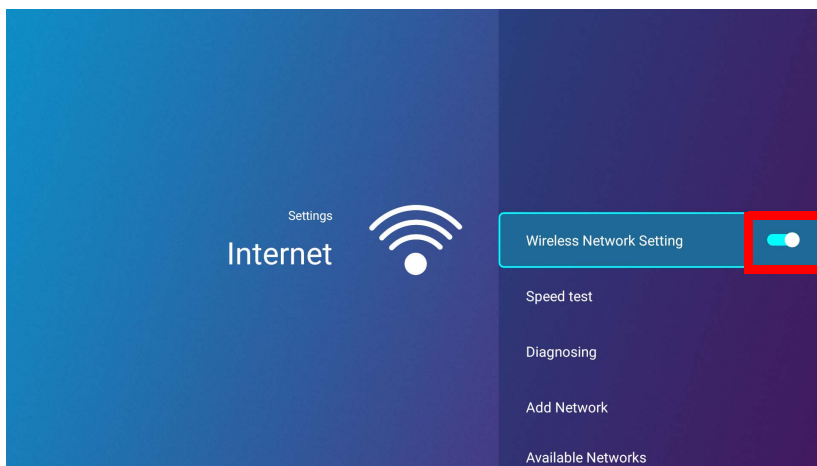

5. Select the SSID for the wireless AP you want to connect to and press **OK**.

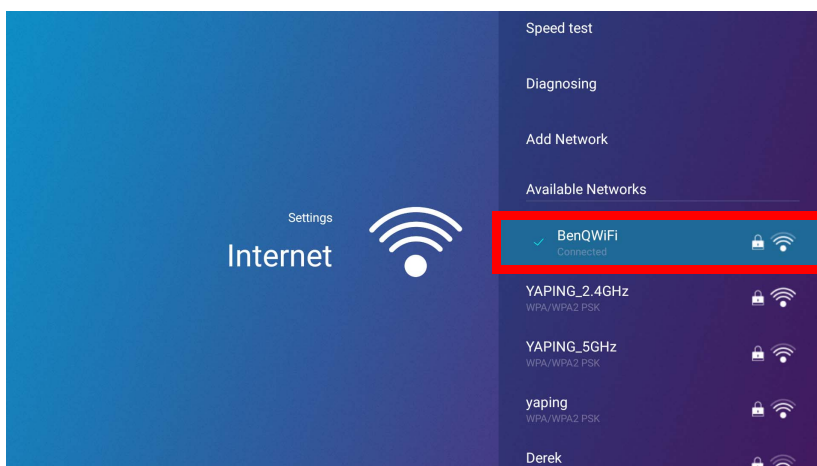

- To connect to a hidden wireless network select **Add A Network** and enter the SSID, security setting, and password for the network.
- The list of available wireless networks will be refreshed every 10 seconds. If the desired SSID is not listed please wait for refreshing to complete.

6. If you chose a secured SSID for the first time, a window appears prompting you to enter the appropriate password. Use the virtual keypad to enter the password. After you have entered the password, select **Next** and the projector will automatically connect.
 - The password will be stored in the projector's memory. In the future, if you select the same SSID again, you will not be prompted to enter a password unless you delete the SSID from the projector's memory.
 - If the password is typed incorrectly, you can select either re-enter the password or press the back button ↶ to return to the list of SSIDs.
7. Once you have successfully connected to the wireless AP a wireless connection icon will appear at the top right corner of the **BenQ Launcher** interface. You can now connect your devices wirelessly to the projector to cast your device's screen.

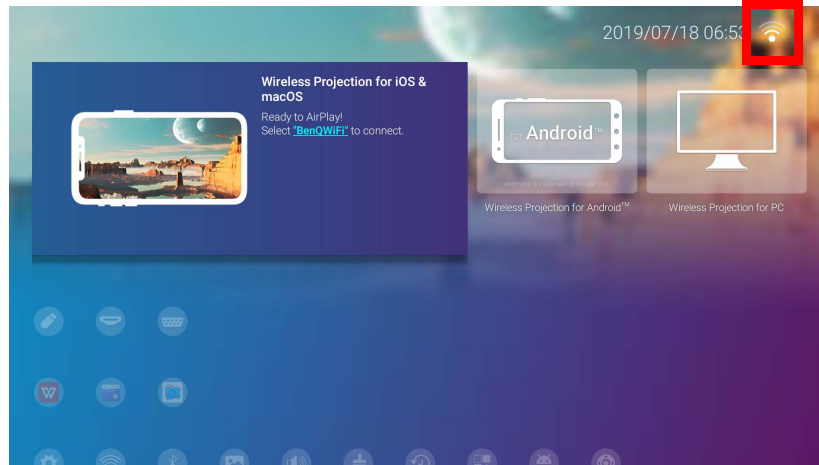

Wireless Projection for iOS & macOS®

To connect an iOS device to the projector and cast your device's screen via AirPlay:

- I. On the home screen of the **BenQ Launcher** interface, select **Wireless Projection for iOS & macOS** and press **OK**.

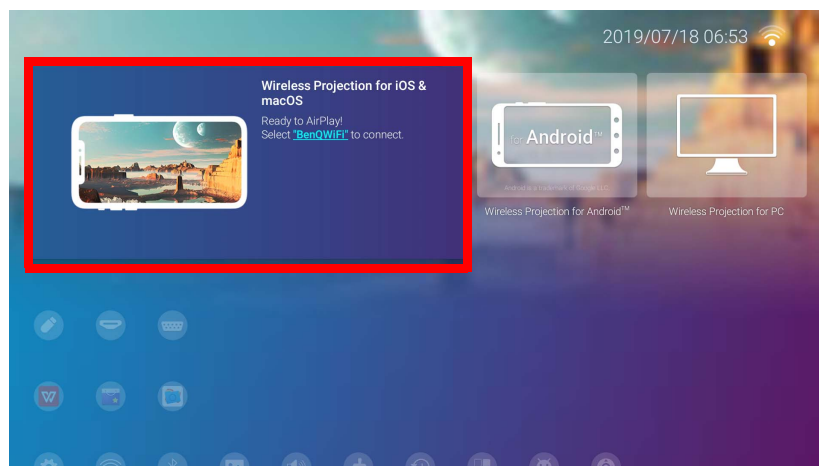

2. On your iOS mobile device's wireless network menu connect to the wireless network shown on the **Wireless Projection for iOS & macOS** screen and then select **Next**.

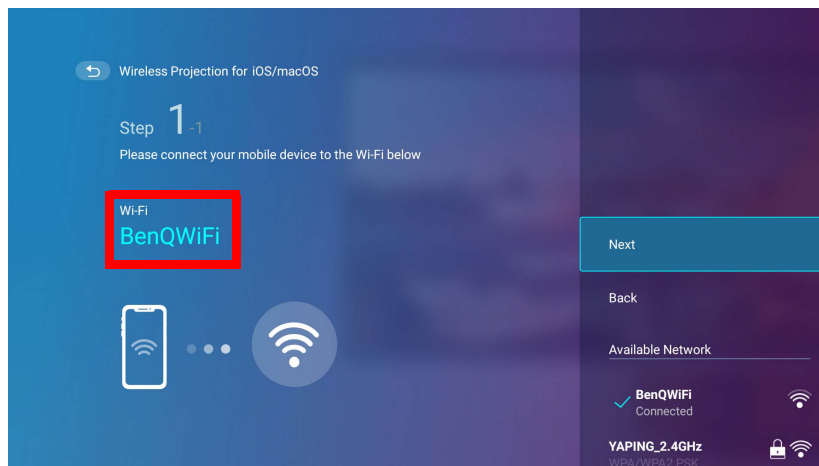

3. Follow the instructions shown on the **Wireless Projection for iOS & macOS** screen to project your iOS device's screen via AirPlay.

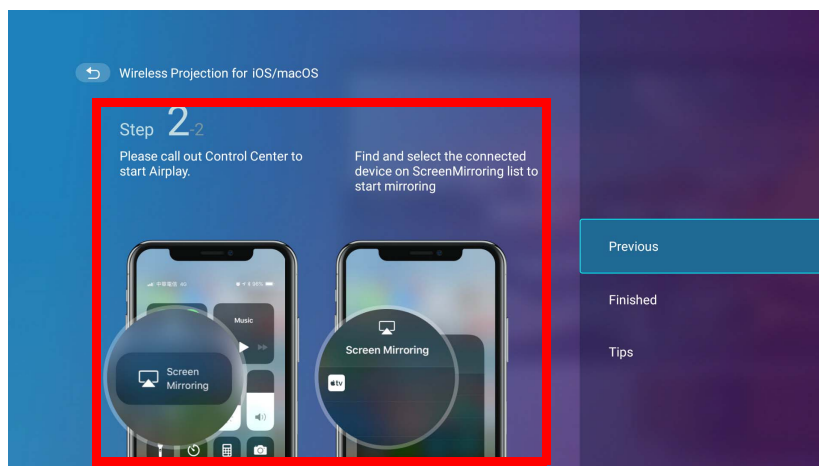

4. Select **Finished** on the **Wireless Projection for iOS & macOS** menu to finish the tutorial and return to the home screen.

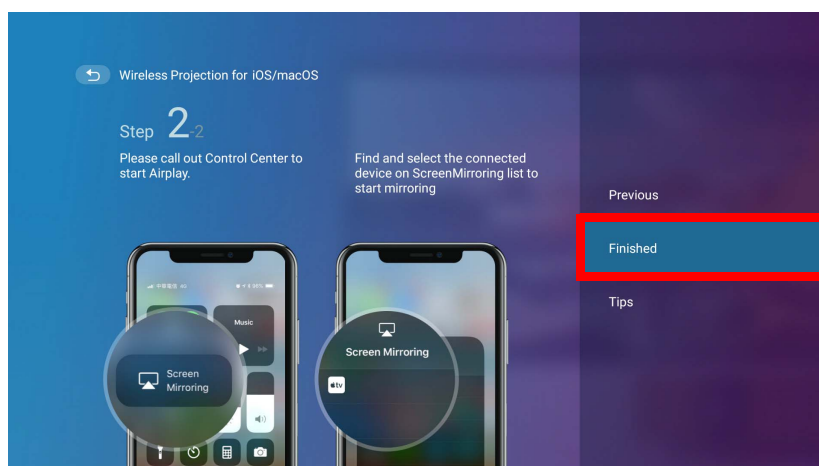

The quality of the wireless projection may depend on the quality of the wireless signal along with the screen mirroring compatibility of the mobile device.

Once you have finished projecting, disable AirPlay on your iOS device to end the connection.

Wireless Projection for Android™

To connect an Android™ device to the projector and cast your device's screen:

1. On the home screen of the **BenQ Launcher** interface, select **Wireless Projection for Android™** and press **OK**.

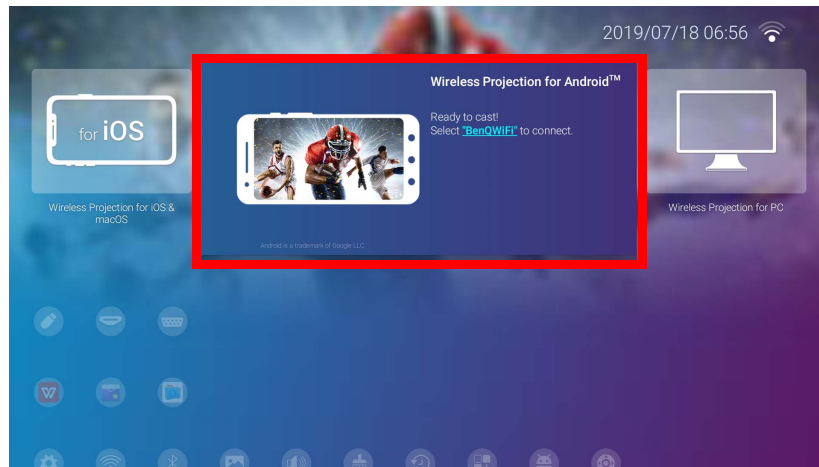

2. On your Android mobile device's wireless network menu connect to the wireless network shown on the **Wireless Projection for Android™** screen and then select **Next**.

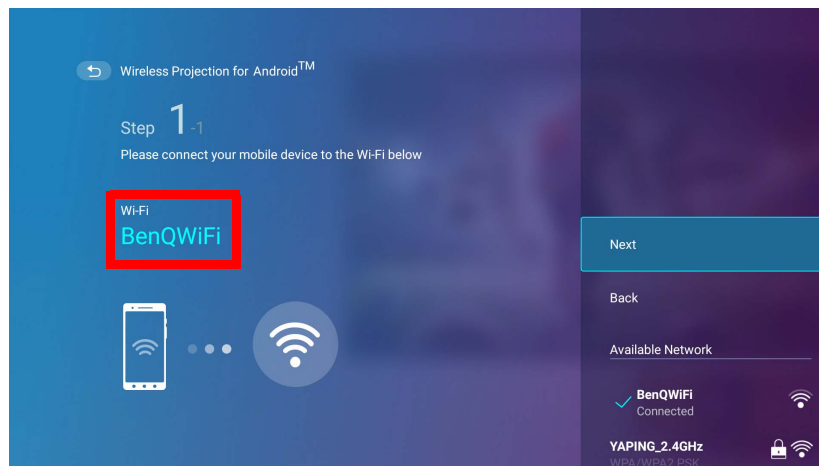

3. Follow the instructions shown on the **Wireless Projection for Android™** screen to project your Android device's screen.

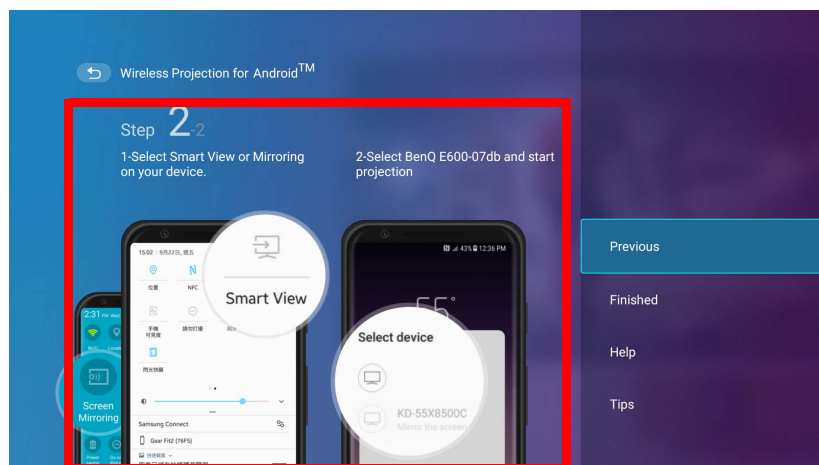

4. Select **Finished** on the **Wireless Projection for Android™** menu to finish the tutorial and return to the home screen.

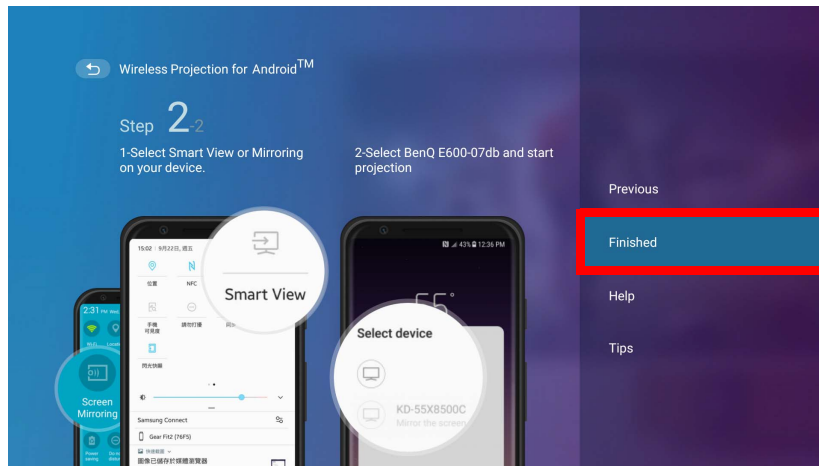

 The quality of the wireless projection may depend on the quality of the wireless signal along with the screen mirroring compatibility of the mobile device.

Once you have finished projecting, disable screencasting on your Android device to end the connection.

Wireless Projection for PC

To connect an PC to the projector and cast your PC's screen:

1. On the home screen of the BenQ Launcher interface, select **Wireless Projection for PC** and press **OK**.

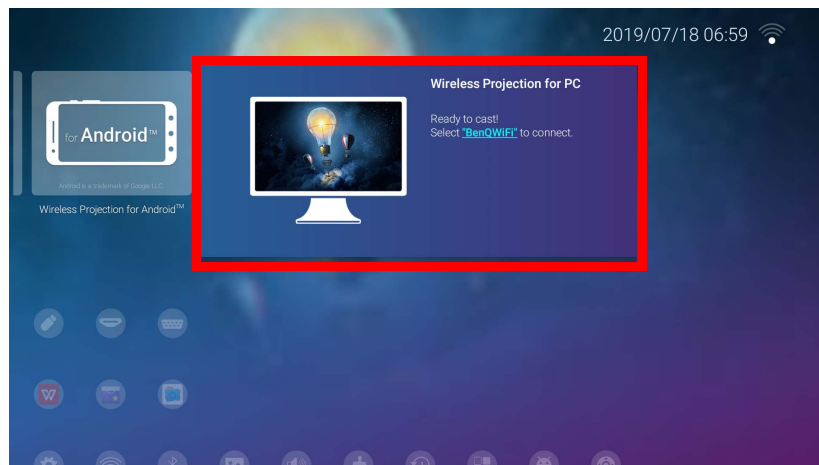

2. On your PC's wireless network menu connect to the wireless network shown on the **Wireless Projection for PC** screen and then select **Next**.

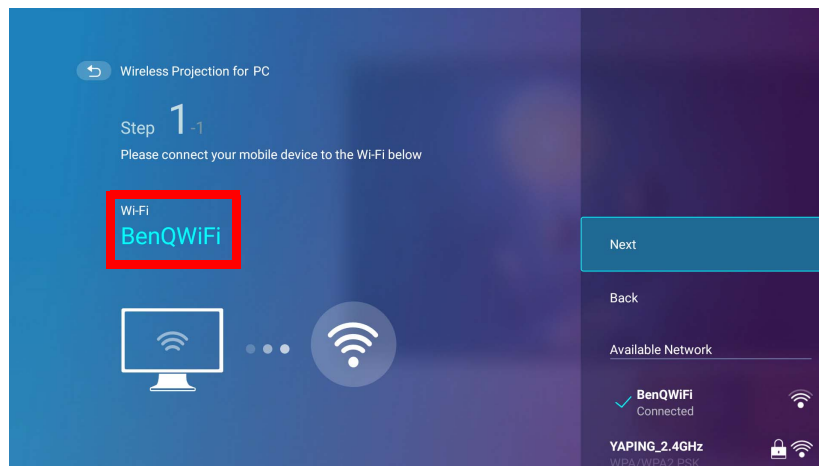

3. Follow the instructions shown on the **Wireless Projection for PC** screen to project your PC's screen.

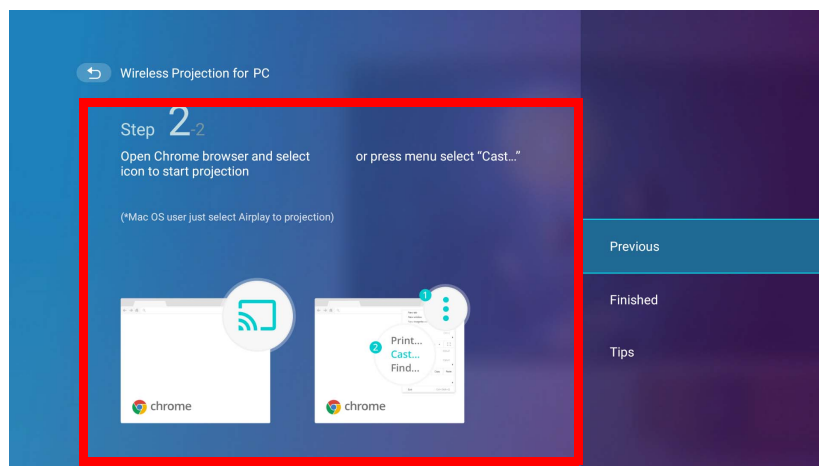

4. Select **Finished** on the **Wireless Projection for PC** menu to finish the tutorial and return to the home screen.

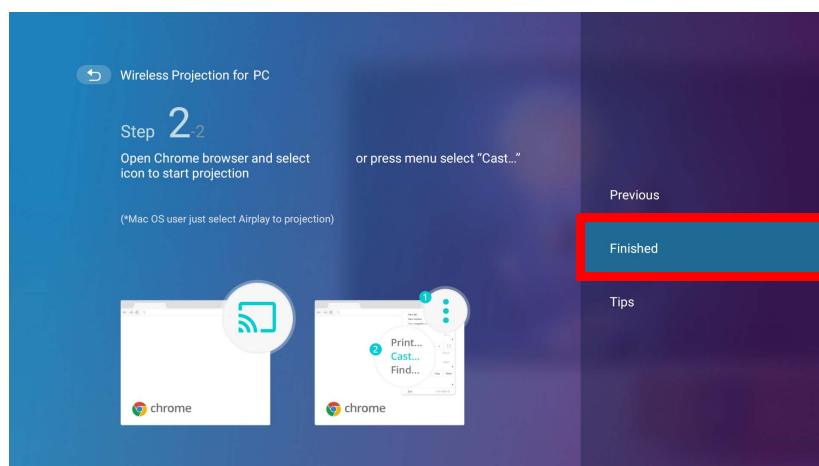

The quality of the wireless projection may depend on the quality of the wireless signal along with the screen mirroring compatibility of the PC.

Once you have finished projecting, disable screencasting on your PC to end the connection.

Wireless Hotspot

In situations where the projector is out-of-range of a wireless network (for example while on a camping trip), you can configure the projector to act as a wireless hotspot to create a closed network for devices to connect directly to the projector via a wireless connection and to project files from their local storage.



The projector will have no access to the Internet while in wireless hotspot mode.

To create a wireless hotspot:

1. Install the wireless dongle provide into the wireless dongle port (see [Installing the wireless dongle on page 8](#)).
2. Power on the projector (see [Starting up the projector on page 22](#)).
3. On the home screen of the **BenQ Launcher** interface, press the down arrow ▼ key the three times to navigate to the **Settings** menus.
4. Select **Settings** and press **OK**.

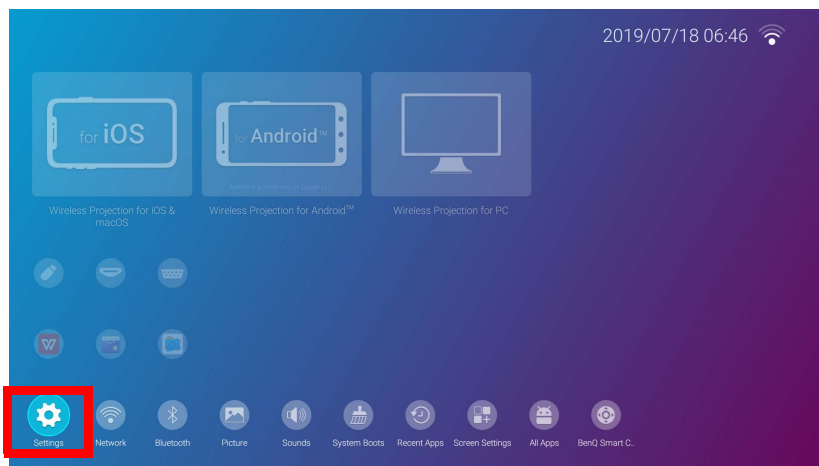

5. Select **Hotspot** and press **OK**.

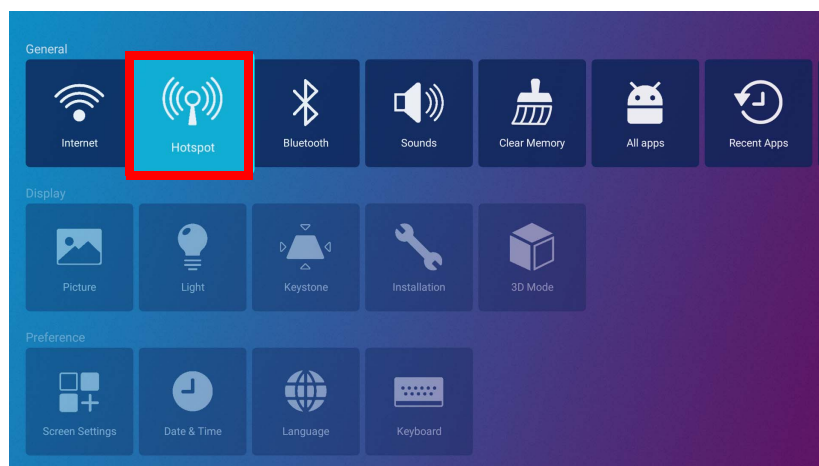

6. (Optional) Select **Hotspot Password** and press **OK** to change the password of the wireless hotspot.

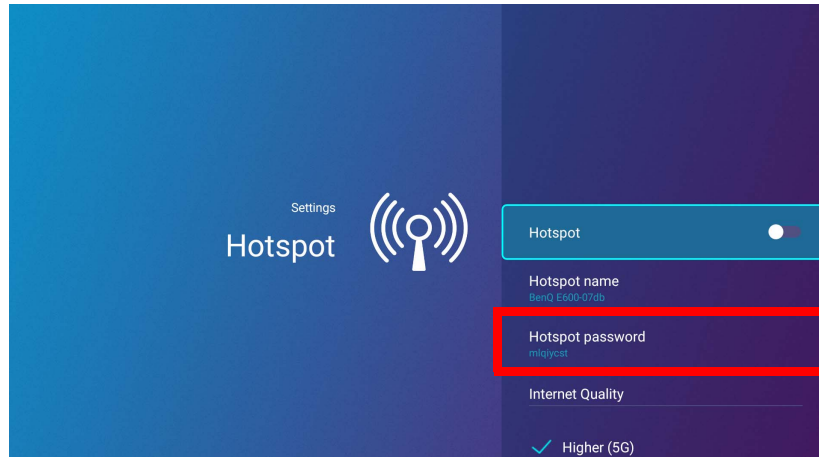

The projector will have no access to the Internet while in wireless hotspot mode.

7. Select **Hotspot** and press **OK** to enable wireless hotspot.

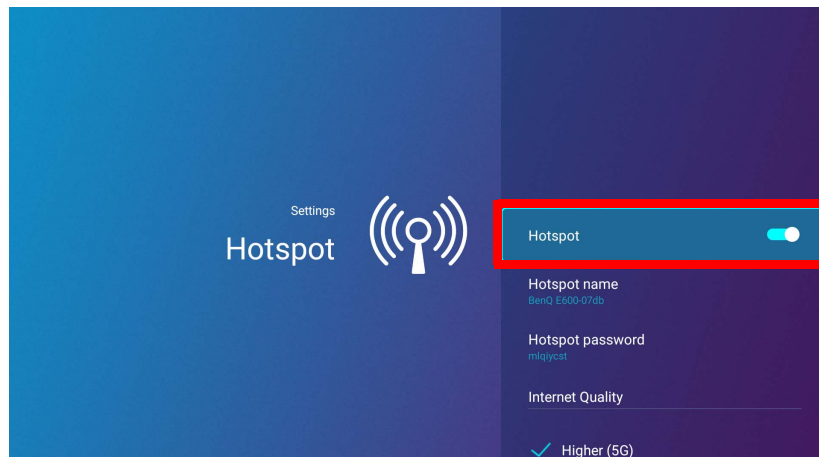

8. Once wireless hotspot is enabled, use the name shown in the **Hotspot Name** field as the SSID to connect to from your mobile device's wireless menu and use the password shown in the **Hotspot Password** field as the connection password.

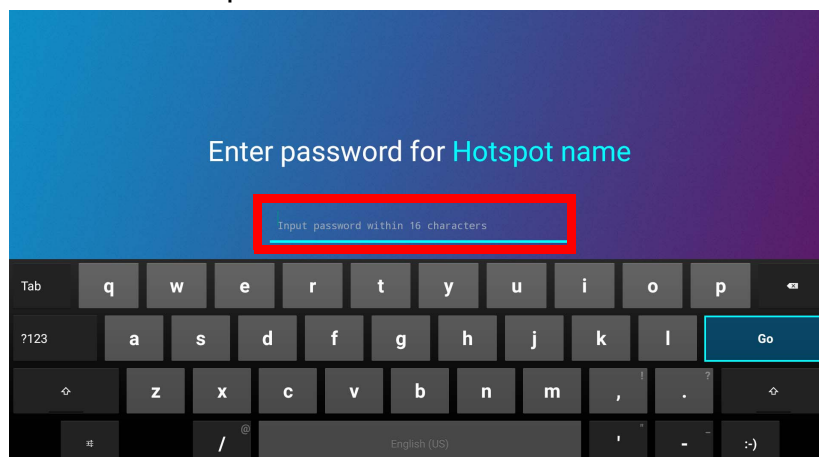

9. If the wireless hotspot can not be found by your device, select **Normal (2.4G)** under the **Internet Quality** heading.

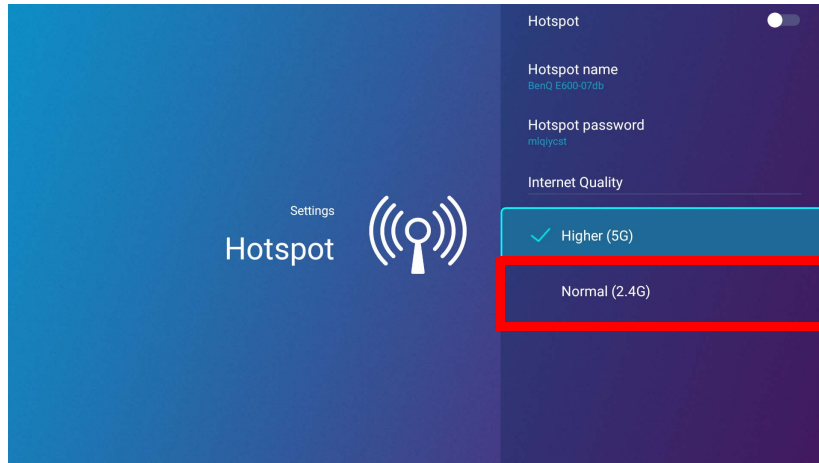

After the wireless hotspot is setup, follow the corresponding connection instructions described in the previous section(s) to connect to the projector directly and cast your device's screen.

External Storage Connections

Connecting a flash drive

Connect a USB-A flash drive to the **USB-1** or **USB-2** port at the rear of the projector to play files stored on the flash drive.

- If you want to play media from a flash drive while the projector is set to the **HDMI** or **PC** input source, you must first return to the **BenQ Launcher** interface by pressing the source button  or the **LAUNCHER** button on the remote control and then selecting **BenQ Launcher**.
- A red dot will appear above the **USB** icon in the **Source** menu anytime a USB-A flash drive is connected to the projector.

To play files stored on a flash drive:

1. Connect the USB-A flash drive to the **USB-1** or **USB-2** port at the rear of the projector.
2. A pop-up notification from the **File Manager** app will appear indicating that a storage device is detected. Select **All Files** and press **OK** to open the device.

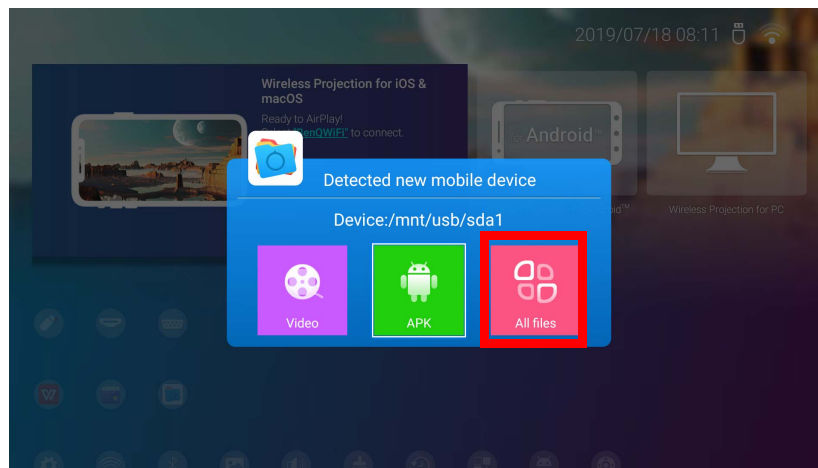

- If you do not want to open the media file immediately after connecting the storage device, press the back button  to remain on the current screen.
- If you are trying to open a media file from a storage device that was already previously connected, select **USB** in the **Source** menu, press **OK**, and select **All Files**.

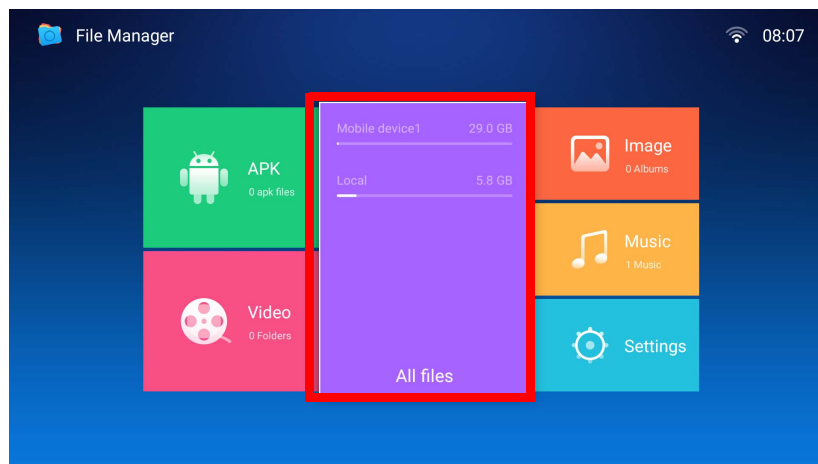

3. The **File Manager** app will launch and show selections for your connected device, select **Mobile Device1** and press **OK**.

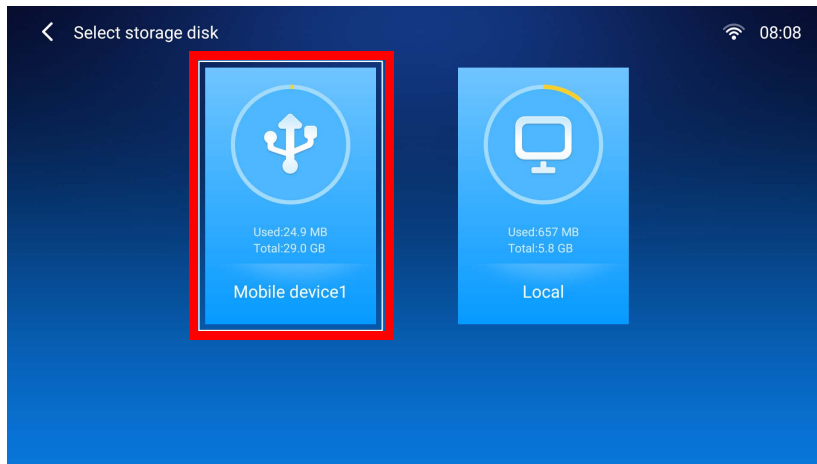

If flash drives are connected to both USB-A ports at the rear of the projector, select **Mobile Device1** for the storage device that was connected first or **Mobile Device2** for the storage device that was connected most recently.

4. Navigate to the folder where the media file you want to play is located and press **OK**.

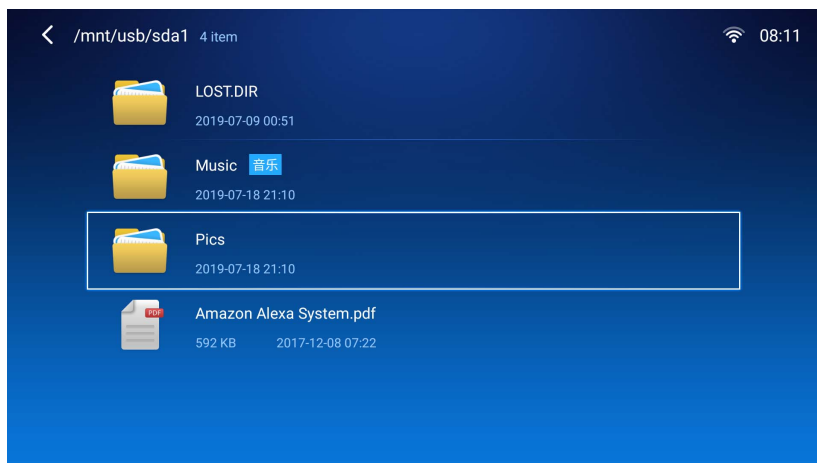

5. Select the media file you want to play and press **OK**.

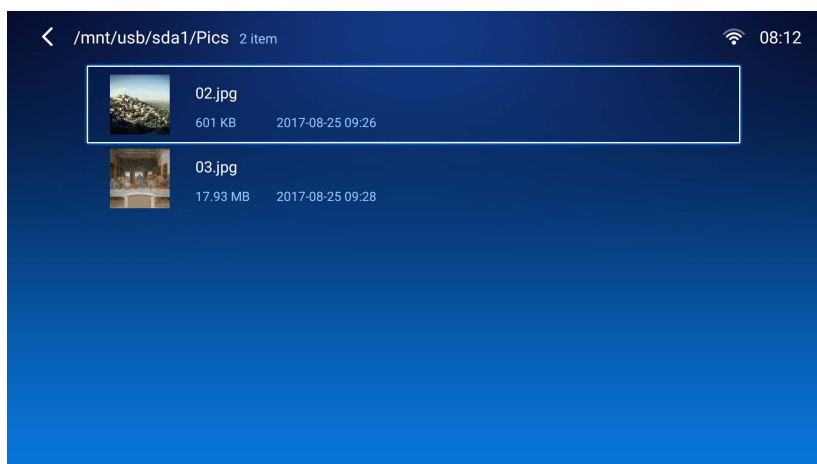

6. A prompt will appear asking you to choose a media player app, select the app you want to use to open the media file and press **OK**.

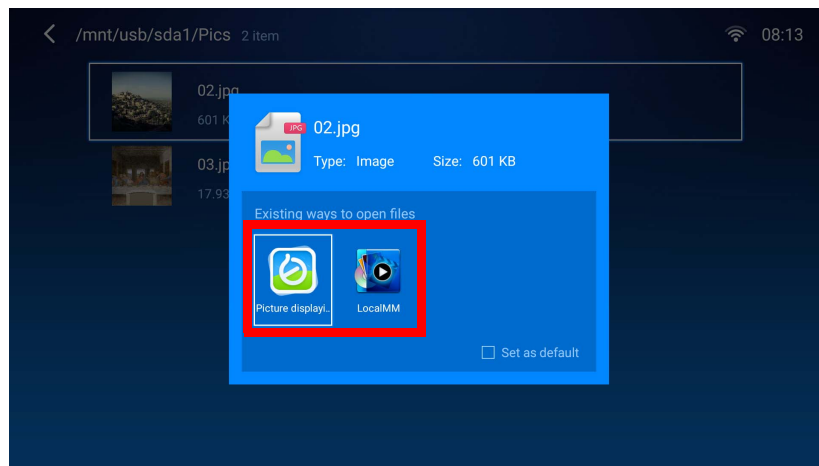

- Check the **Set as default** box to configure the selected media player app as the default app for opening the type of media file (e.g. video, photo, music) of the selected file.

7. The media file will open in the selected media player app.

Using **WPS Office** to view documents

The **WPS Office** app allows you to open document files including PDFs as well as Microsoft Word, PowerPoint and Excel documents.

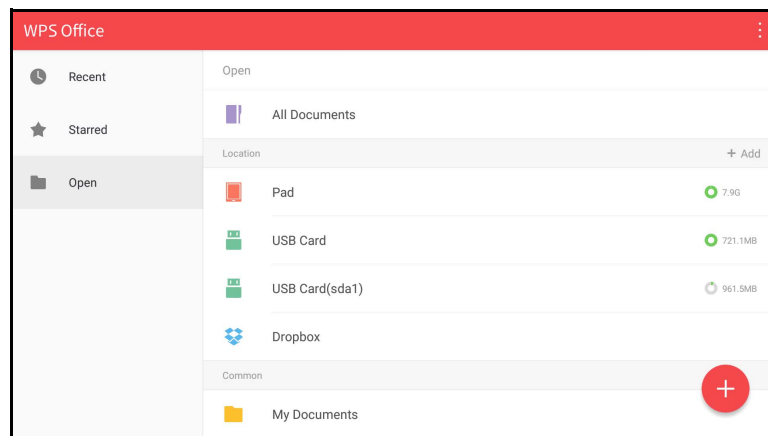

To edit a file with **WPS Office**:

1. Select **Open** () on the left panel to browse and open a file located in either the projector's internal memory or an external storage device.

Select the function menu on the top panel to access the file format's various functions.



The description below is for a PowerPoint file, the function menus for other file formats will vary.

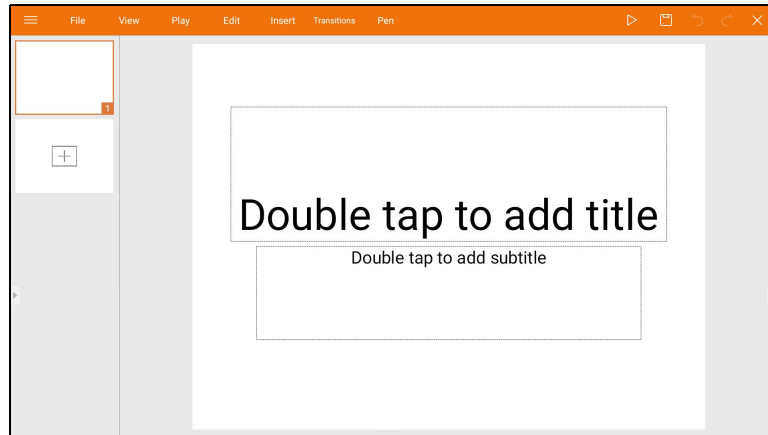

Function	Description
File	Select to open, save, share, print, and manage your presentations.
View	Select to change or edit the presentation views.
Play	Select to start or set up a slide show.
Edit	Select to edit the content or format of the slides.
Insert	Select to insert tables, pictures, charts, comments, video, or audio.
Transitions	Select to apply or adjust the timing of a transition.
Pen	Select to write, draw, paint or sketch to the slides.
Play (▶)	Select to start a slide show.
Save As (📁)	Select to save the presentation file on either the display's internal memory, an external storage device, or cloud storage.
Undo (↶)	Select to undo an action.
Redo (↷)	Select to redo the last action.
Close (✕)	Select to close the presentation file.
Back (←)	Select to return to the previous page.
Next (→)	Select to go to the next page.
Exit (⌫)	Select to exit WPS Office.

Bluetooth Connections

The projector is able to connect to a Bluetooth-enabled speaker or headphones to output audio directly for greater sound, particularly in outdoor settings.



- The Bluetooth connection does not support any data transfer as the projector only allows Bluetooth connections for audio output.
- You may not use the projector to broadcast audio from a Bluetooth-enabled mobile device.

Pairing/Connecting to a Bluetooth speaker or headphones

Pairing is the process by which your projector creates a connection to a Bluetooth speaker or headphones for the first time. Once both devices have been successfully paired each device will have the corresponding device's pairing information stored internally and both will be able to connect automatically when they are within an ~10 meter range of each other and Bluetooth is enabled on the projector.

To pair your projector to a Bluetooth speaker or headphones:

1. Install the provided wireless dongle into the wireless dongle port (see [Installing the wireless dongle on page 8](#)).
2. Power on the projector (see [Starting up the projector on page 22](#)).
3. Press the down arrow key ▼ and right arrow ► key to navigate to the settings sub-menu shortcuts.
4. Select **Bluetooth** and press **OK**.

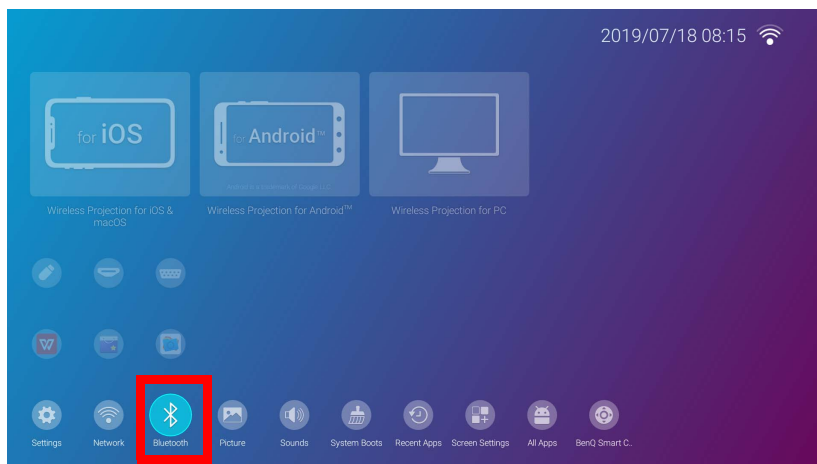

5. Select **Bluetooth** and press **OK** to enable Bluetooth.

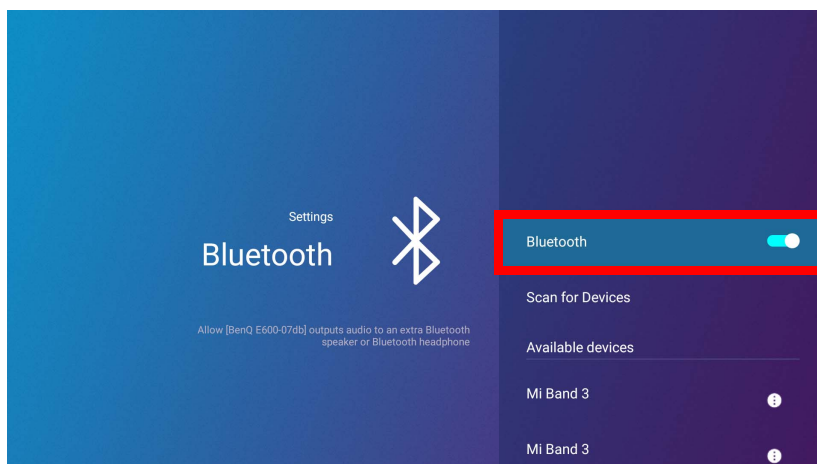

6. Activate Bluetooth-pairing mode on the speaker or headphones.
7. Select the speaker or headphones from the **Device List** in the **Bluetooth** setting menu and press **OK**.

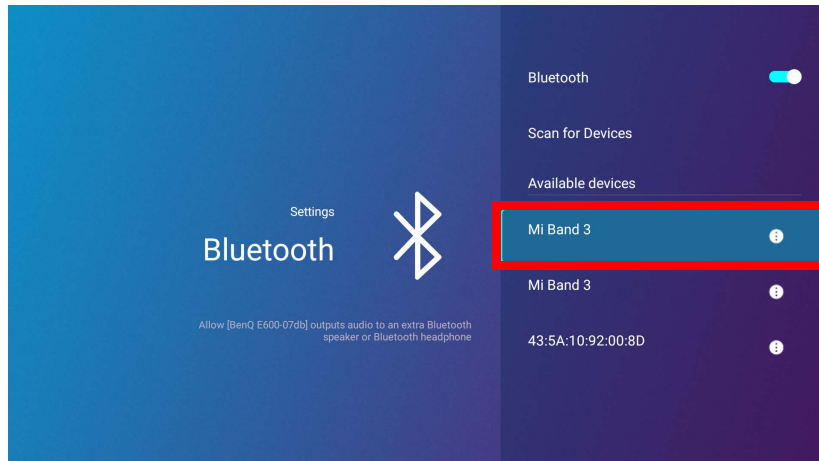

8. When the projector and speaker or headphones have successfully connected the device listing in the Bluetooth setting menu will be labeled **Connected**, you can now output the audio from the projector to the speaker or headphone.

Once you have successfully paired your projector with the Bluetooth speaker, pairing information will be stored on both devices and a connection will automatically be made when Bluetooth is enabled on both devices and both devices are within range of each other.



- If you replace the wireless dongle on your projector anytime after you have paired your projector with a Bluetooth device you will need to re-pair your projector to the device in order to create a Bluetooth connection.
- The quality of the Bluetooth transmission may depend on the quality of the Bluetooth signal along with the compatibility of the mobile device.

Ending the Bluetooth connection

In cases where you want to disconnect a speaker or headphones from the projector and connect to another speaker or headphones follow the steps below:

1. Press the down arrow key ▼ and right arrow ► key to navigate to the settings sub-menu shortcuts.
2. Select **Bluetooth** and press **OK**.
3. Select the already connected speaker or headphones from the **Device List** in the **Bluetooth** setting menu and press **OK**.
4. Confirm that you want to disconnect the speaker or headphones from the projector.
5. Activate Bluetooth-pairing mode on the new speaker or headphones.
6. Select the new speaker or headphones from the **Device List** in the **Bluetooth** setting menu and press **OK**.

Deactivating the Bluetooth speaker or headphones

To deactivate Bluetooth on the projector so that it no longer outputs its audio to a separate speaker or headphones:

1. Press the down arrow key ▼ and right arrow ► key to navigate to the settings sub-menu shortcuts.
2. Select **Bluetooth** and press **OK**.

3. Select **Bluetooth** and press **OK** to disable Bluetooth.

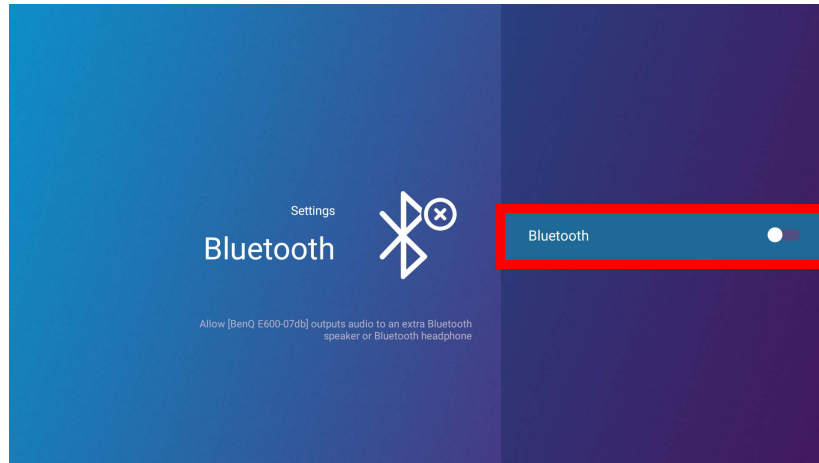

Apps

The **Shortcut** section of **BenQ Launcher** features shortcuts to the pre-installed **File Manager**, and **BenQ Suggests** apps, as well as a customizable selection of downloaded apps.

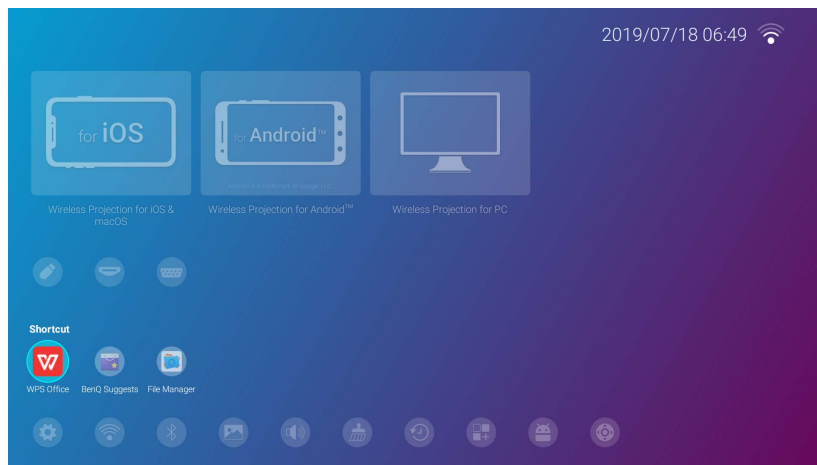

Certain apps require the use of a mouse and/or keyboard to operate. It is suggested that you connect a mouse and/or keyboard to the projector before opening any apps from the **Shortcut** section.

To access all the apps installed on the projector, select **All Apps** in the **Settings** menu, see [All Apps on page 134](#).

To configure the apps that appear in the **Shortcut** section, see [Screen Settings on page 138](#).

BenQ Suggests

The **BenQ Suggests** allows you to view apps suggested by BenQ for download.

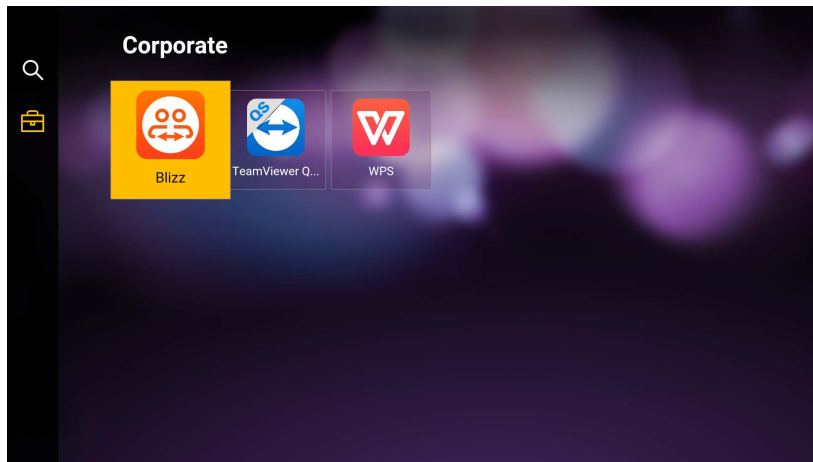

Select the category on the left panel to browse the suggested apps based on the type. Select an app from the selected category and press **OK** to view a basic description of the app and access the download link.





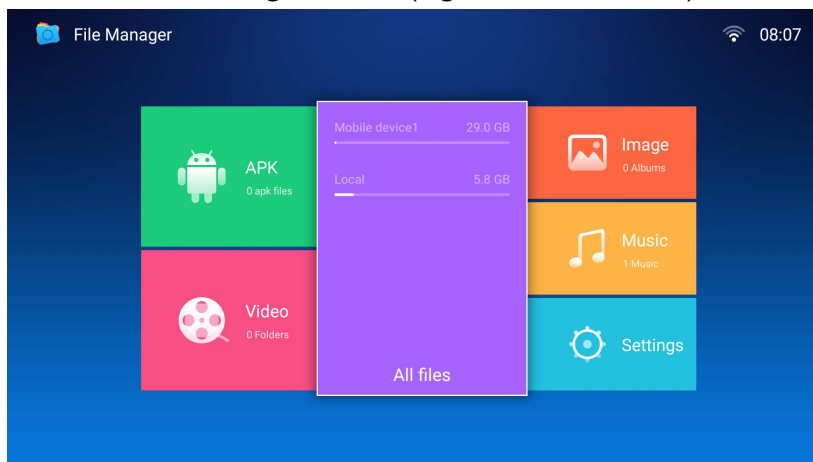

Certain apps require the use of a mouse and/or keyboard to operate. It is suggested that you connect a mouse and/or keyboard to the projector before downloading any apps from **BenQ Suggests**.

File Manager

The **File Manager** app allows you to browse, open, and manage files stored on your projector's internal storage or in connected storage devices (e.g. a USB flash drive).



Function	Description
APK	<p>Select to open the list of available installation files for Android apps stored internally or on an external storage device.</p>  <p>For APK files located on external storage devices, the files must be saved in the outer most directory of the storage device to be able to be detected by File Manager.</p>

Function	Description
Video	<p>Select to open the list of available video files stored internally or on an external storage device.</p>  <p>For video files located on external storage devices, the files must be saved in the outer most directory of the storage device to be able to be detected by File Manager.</p>
All Files	<p>Select to browse the various storage options for the projector including internal storage or connected external storage devices.</p> <p>Select Local to browse the projector's internal storage, select Mobile Device1 or Mobile Device2 to browse external storage devices. For information on opening media files located on external storage devices, see Connecting a flash drive on page 120.</p>
Image	<p>Select to open the list of available image files stored internally or on an external storage device.</p>  <p>For image files located on external storage devices, the files must be saved in the outer most directory of the storage device to be able to be detected by File Manager.</p>
Music	<p>Select to open the list of available music files stored internally or on an external storage device.</p>  <p>For music files located on external storage devices, the files must be saved in the outer most directory of the storage device to be able to be detected by File Manager.</p>
Settings	<p>Select to configure file management settings including options for Display Mode, Auto cleaning up APK file, Image view, Quick Open, Hidden File, and Clear Association.</p>

Navigating the **Settings** Menu

About the **Settings** menu

To let you make various adjustments or settings on the projector, its wireless connections, and the projected image, **BenQ Launcher** provides a **Settings** menu. Under the **Settings** menu are sub-menus for various settings.

To access the **Settings** menu, in the **BenQ Launcher** home screen press the down button ▼ three times, and then select **Settings**.

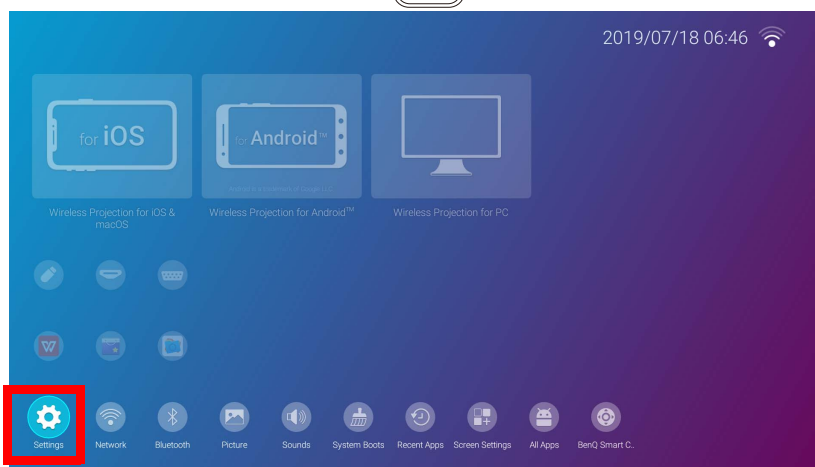

If the projector is not of the latest version of firmware, a red dot will appear on the **Settings** icon. In such a circumstance, users can go to the **About > Software Update** menu and then select **Update** to start firmware update. The red dot will disappear when the projector is updated with the latest version of firmware. See [System Update on page 144](#) for more information.

Under the settings menu there are three subcategories: **General**, **Display**, and **Preference**.

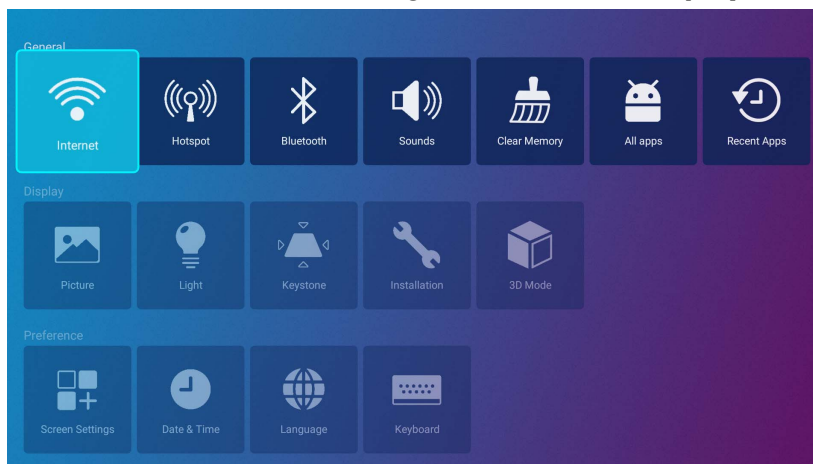

The sub-menus in the **Display** category feature only a partial number of items that adjust your projector's display settings, for a full menu of display related settings enter the **Advanced OSD** settings menu. See [Advanced menu on page 80](#) for a listing of the full **Display** settings.



Using the **Settings** menu

To access the various settings menus:

- Use the left and right arrow keys (◀/▶) to move through the main settings menus.
- Use **OK** to select the desired menu.
- When configuring items within a menu:
 - Use the up and down arrow keys (▲/▼) to move to the item you want to configure.
 - Use left and right arrow keys (◀/▶) to toggle through the available options.
 - Use **OK** to enable/disable options or select sub-menu options.
- Use the back button ↶ to return to the main settings menu.
- Use the home button 🏠 to return to the **BenQ Launcher** home screen.

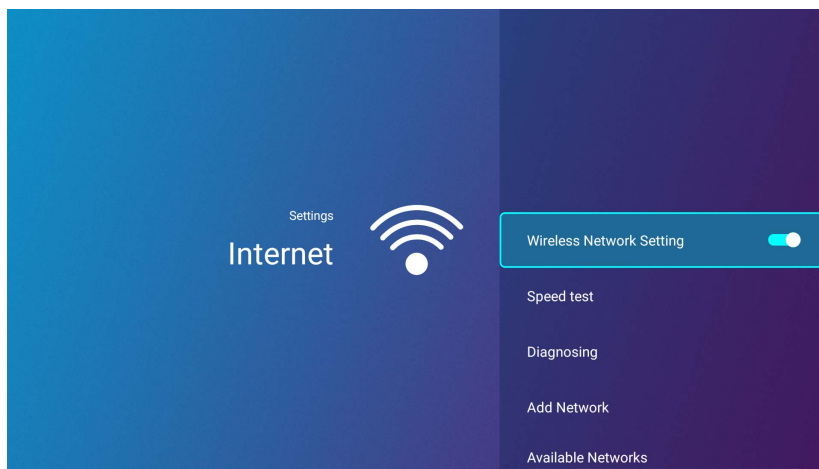

Internet



<p>Wireless Network Settings</p> 	<p>Enables a wireless network connection for the projector. See Connecting the projector to a wireless network on page 110 for details.</p> <p>This function is only available when Hotspot is disabled.</p>
<p>Speed Test</p>	<p>Tests the speed of the projector's Internet connection.</p>
<p>Diagnosing</p>	<p>Diagnoses the status of the projector's Internet connection.</p>
<p>Add Network</p>	<p>Allows you to add a specific network that may be hidden or undetected in the Available Networks. Once selected you will be prompted to enter the SSID and security settings for the network.</p>
<p>Available Networks</p> 	<p>Lists the available wireless access points which the projector can connect to. See Connecting the projector to a wireless network on page 110 for details.</p> <p>Available Networks is only available when Wireless Network Settings is disabled.</p>

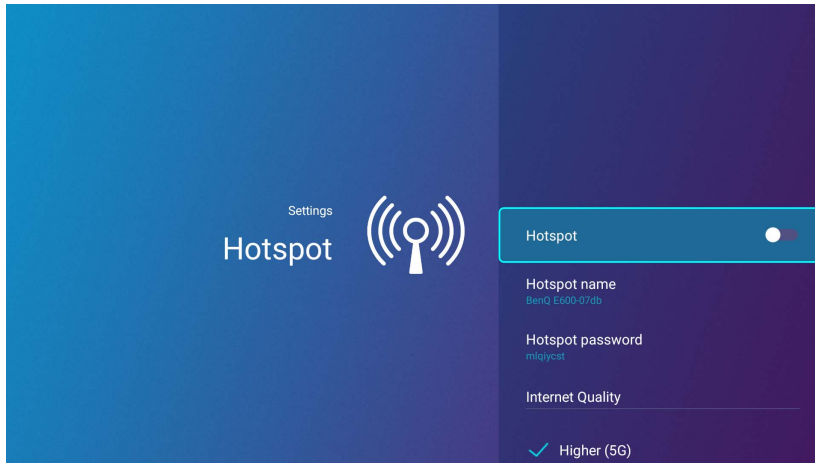

Hotspot

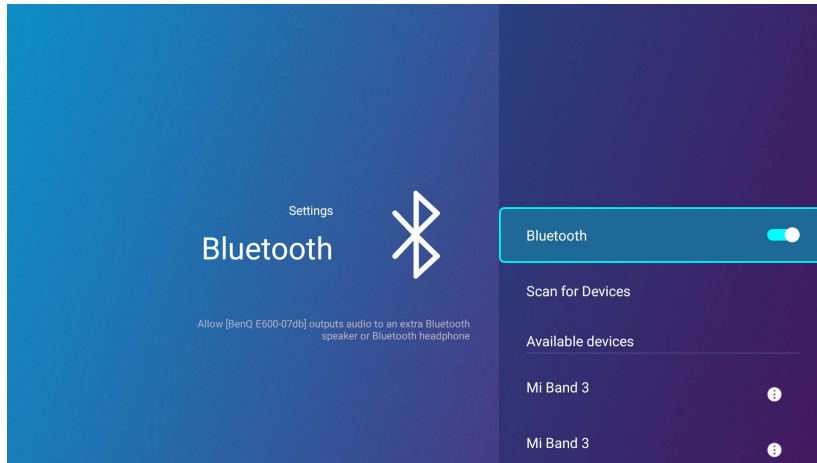

Hotspot	Enables wireless hotspot for the projector, allowing other devices to connect to the projector directly. See Wireless Hotspot on page 117 for details.
Hotspot Name	<p>Sets the name for the projector’s wireless hotspot, which appears in the wireless network list for devices looking to connect directly to the projector.</p> <p></p> <p>The default name for the projector’s wireless hotspot is "BenQ E600-xxxx". The final four digits are the last four digits of its MAC Address.</p>
Hotspot Password	<p>Sets the password for the projector’s wireless hotspot.</p> <p></p> <p>The password needs to be at least 8 characters.</p>
Internet Quality	Sets the frequency for the projector’s wireless hotspot signal. Available options include Higher (5G) and Normal (2.4G) .

Bluetooth



Bluetooth	Enables Bluetooth for the projector, allowing the projector to output its audio to a Bluetooth speaker or headphones.
My Devices	<p> Lists of previously paired Bluetooth devices.</p> <p>This function is only accessible when Bluetooth is enabled.</p>
Scan for Devices	<p> Refreshes the list of devices.</p> <p>This function is only available when Bluetooth is enabled.</p>
Available Devices	<p> Lists the available Bluetooth devices which the projector can pair and connect to.</p> <p>This function is only available when Bluetooth is enabled.</p>

Sounds

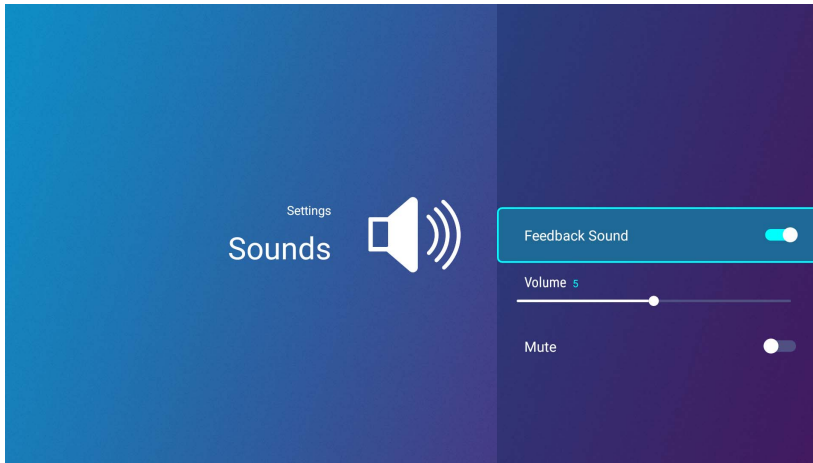

Feedback Sound	Enables/Disables feedback on the audio provided by the projector.
Volume	Adjusts the sound level for the projector.
Mute	Disables/Enables audio for the projector.

Clear Memory

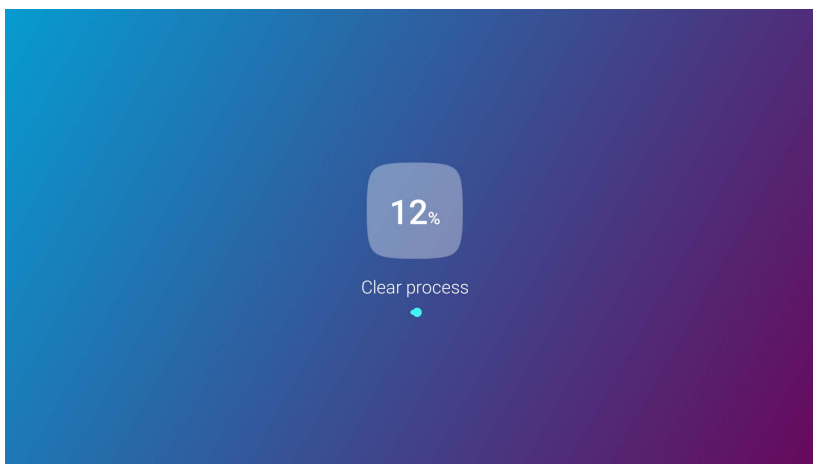

Clears out the memory of unnecessary files and boosts available RAM.

All Apps

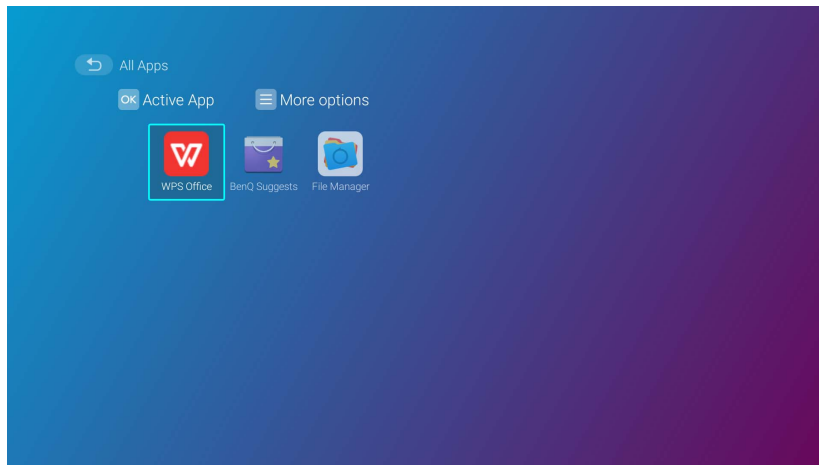



Select the **All Apps** menu to access all the apps that have been installed on the projector.

- Select an app and press **OK** to launch the app.
- Select an app and press the menu button () to uninstall the app.

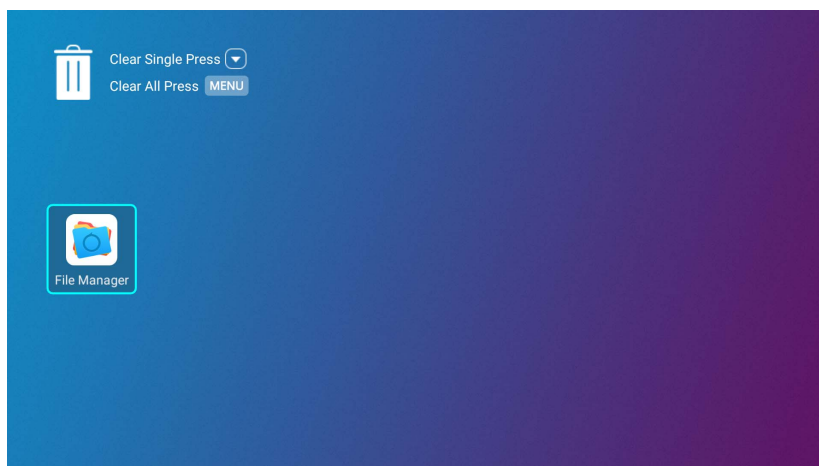
Recent Apps



Select the **Recent Apps** menu to access a list of apps that have been recently used.

- Select any icon and press the down button () to remove the icon from the list of recently used apps.
- Select any icon and press the menu button () to clear all icons from the list of recently used apps.

About

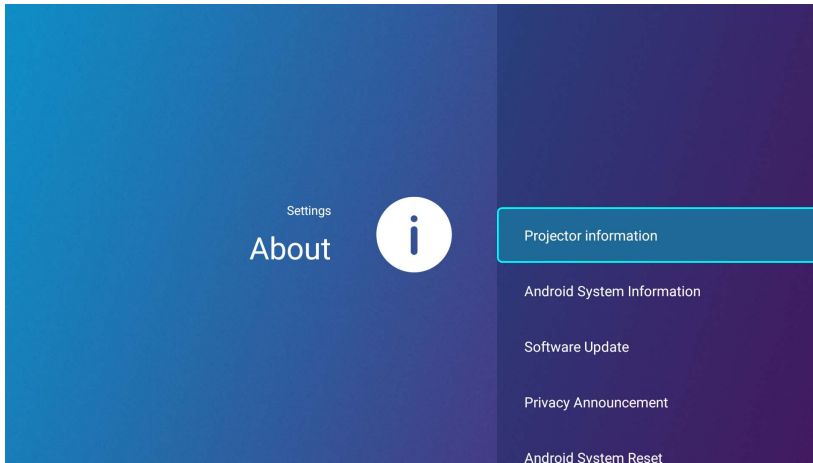

Projector Information	Displays information on the current status of the projector including the current Native Resolution, Picture Mode, Light Mode, Light Usage Time, Firmware Version, and Service Code.
Android System Information	Displays information on the Android operating system including Android Version, Ram, System storage, Internal storage, and MAC address.
Software Update	Allows you to update the Android operating system via an Over-The-Air (OTA) update or a USB flash drive. For more information see System Update on page 144,
Privacy Announcement	Allows you to view and accept or reject BenQ's privacy policy.
Android System Reset	Returns all settings to the factory preset values.

Picture

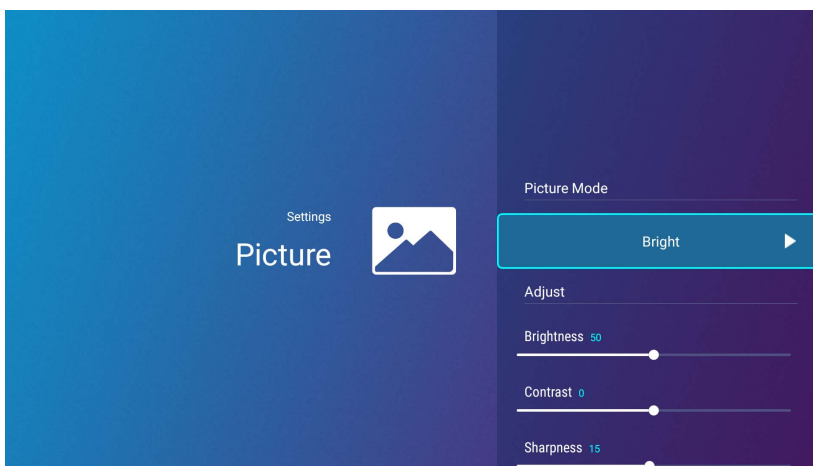

The options available for the **Picture** settings menu are the same as the options available in the OSD menu. See **Advanced menu on page 80** for the **Picture** settings options.

Light Settings

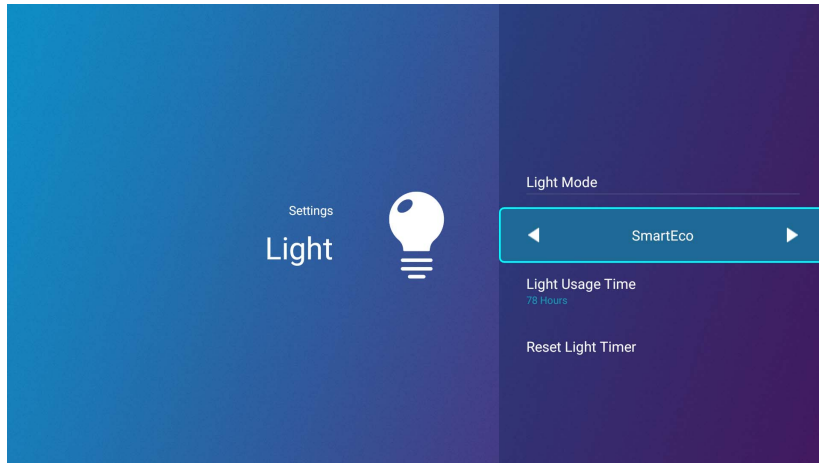

The options available for the **Light Settings** settings menu are the same as the options available in the OSD menu. See [Advanced menu on page 80](#) for the **Light Settings** settings options.

Keystone

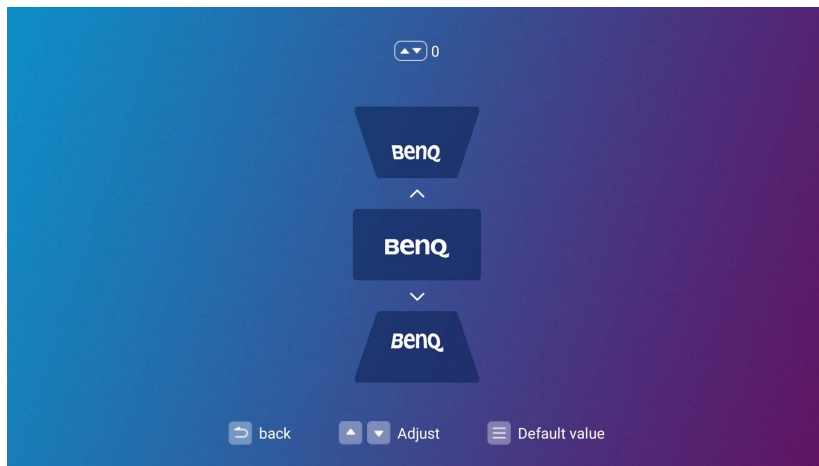

The options available for the **Keystone** settings menu are the same as the options available in the OSD menu. See [Advanced menu on page 80](#) for the **Keystone** settings options.

Projector Position

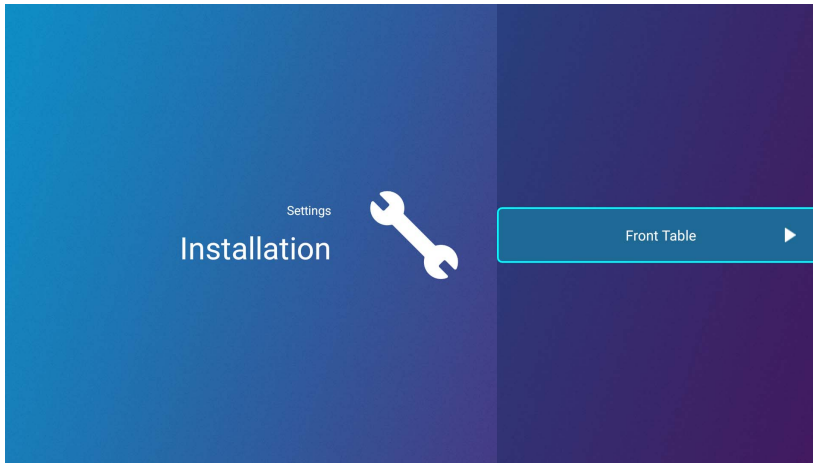

The options available for the **Projector Position** settings menu are the same as the options available in the OSD menu. See [Advanced menu on page 80](#) for the **Projector Position** settings options.

3D

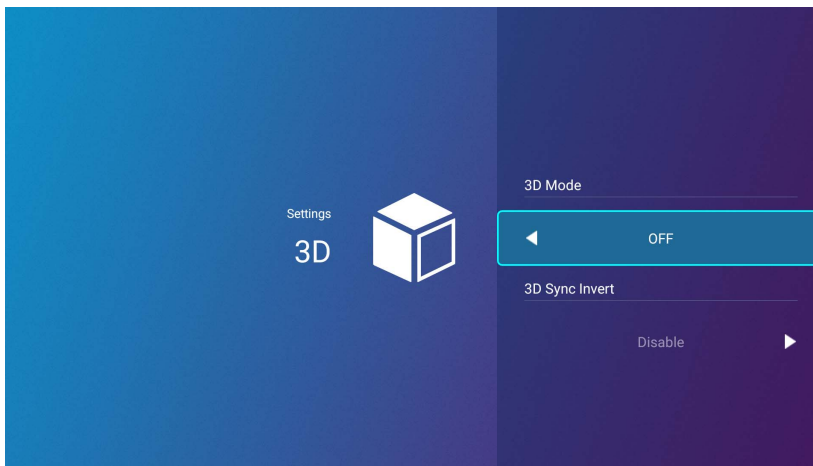

The options available for the **3D** settings menu are the same as the options available in the OSD menu. See [Advanced menu on page 80](#) for the **3D** settings options.

Screen Settings

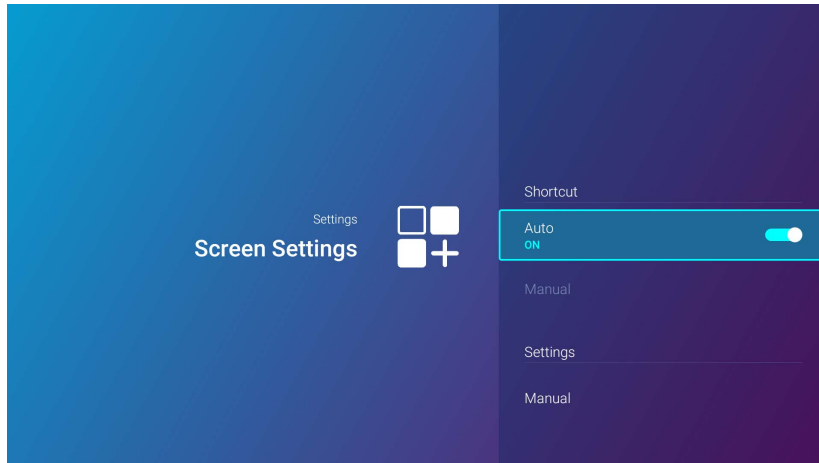

<p>Shortcut</p>	<p>Sets which app shortcuts are displayed on the BenQ Launcher home screen and their sequence. The home screen requires at least one shortcut and allows up to ten shortcuts.</p> <ul style="list-style-type: none"> • Auto: Enables the projector to automatically arrange the sequence of app shortcuts on the home screen so that the most recently used app will appear first in the row. • Manual: Enables the user to manually arrange which app shortcuts to be displayed on the home screen and their sequence. Press OK on an app in the Adjust menu and then press ◀/▶ to adjust the sequence of the apps in the apps shortcuts section. Press OK on an app in the Show/Hide Apps menu to check (show) or uncheck (hide) the shortcuts. <p></p> <p>This function is only available when Auto is disabled.</p>
<p>Settings</p>	<p>Sets which settings menu shortcuts are displayed on the BenQ Launcher home screen and their sequence. The home screen requires at least one shortcut and allows up to eight shortcuts.</p> <ul style="list-style-type: none"> • Manual: Enables the user to manually arrange which settings menu shortcuts to be displayed on the home screen and their sequence. Press OK on a settings menu in the Adjust menu and then press ◀/▶ to adjust the sequence of the settings menu shortcuts in the settings menu section. Press OK on an settings menu in the Show/Hide settings menu to check (show) or uncheck (hide) the shortcuts.

Date & Time

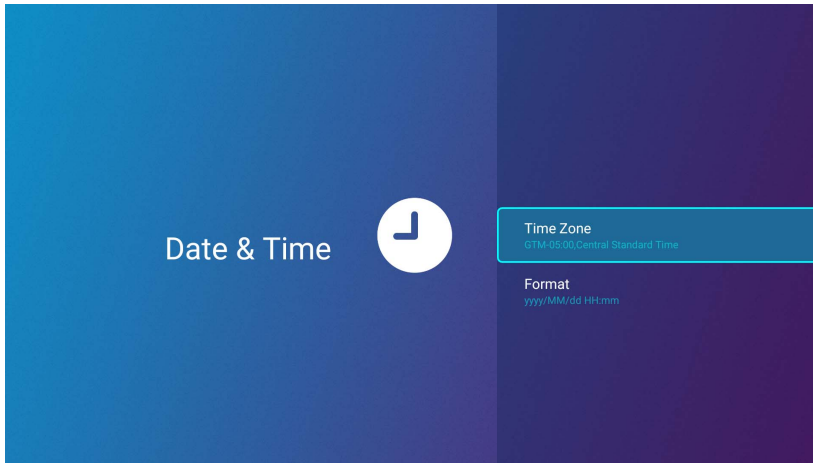

Time Zone	Sets the time zone for the projector
Format	Sets the date and time format as either HH:MM or YYYY/MM/DD HH:MM .

Language

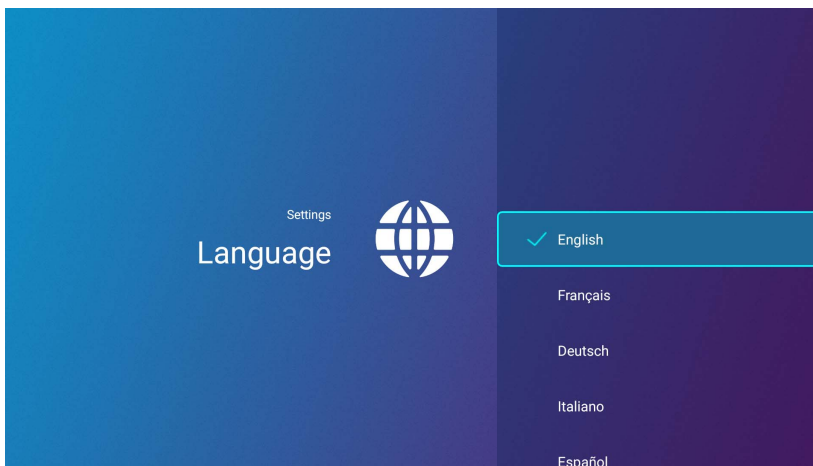

Sets the language for **BenQ Launcher**.

Keyboard

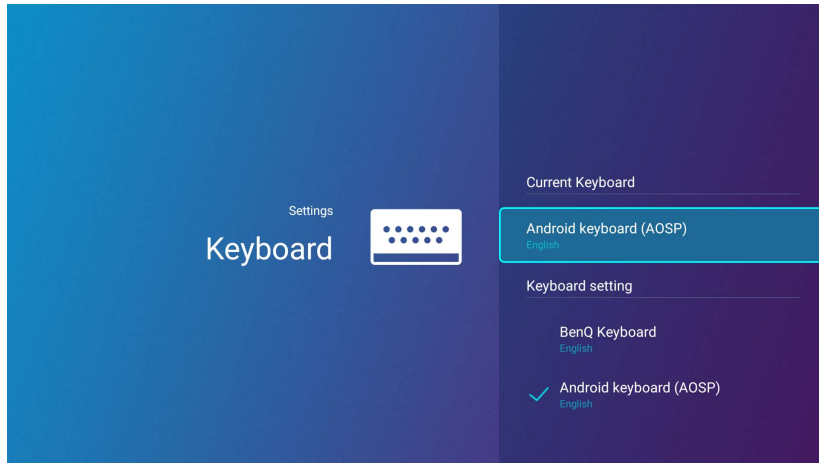

Current Keyboard	Displays the current keyboard setting.
Keyboard Settings	Sets the projector's virtual keyboard for inputting text. The available options are BenQ Keyboard and Android keyboard (AOSP) .  To input Chinese characters, set the language preference to traditional Chinese or simplified Chinese, and set the keyboard to BenQ Keyboard .

BenQ Smart Control

The settings menu also features a link to install the **BenQ Smart Control** app, which lets you transform your smartphone into a remote control to control the projector via buttons and/or touch gestures.

Installing the BenQ Smart Control app on your smartphone

To install the **BenQ Smart Control** app on your smartphone:

1. Choose one of the following options:
 - Connect your smartphone to the same wireless network as your projector.
 - Enable wireless hotspot for your projector and then connect your smartphone to the projector's wireless hotspot. For instructions on how to enable wireless hotspot for your projector see [Hotspot on page 131](#).
2. Select **BenQ Smart Control** in the **Settings** menu of the **BenQ Launcher** home screen and then press **OK**.

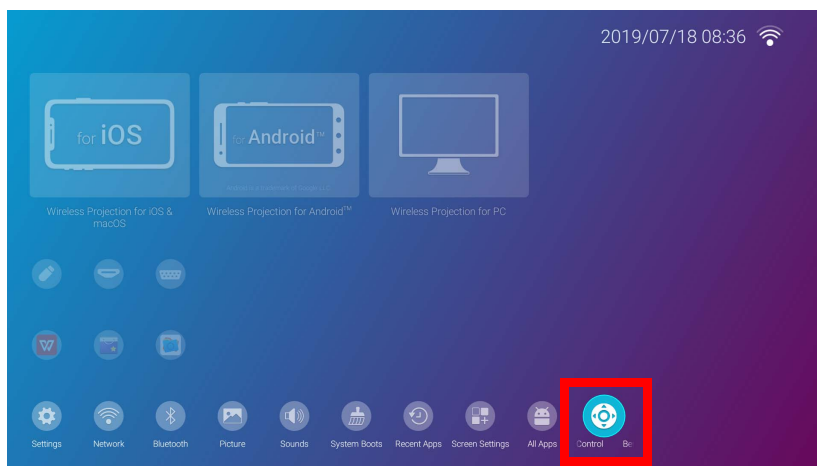

3. Scan the QR code shown on the projector with your smartphone, this will open a download link on your smartphone.

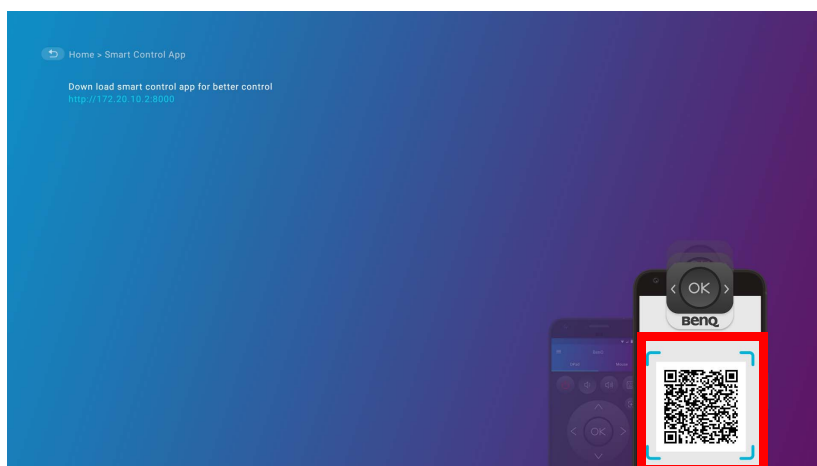

4. Download and install the **BenQ Smart Control** on to your smartphone.



For some smartphones you may first need to allow your smartphones to install apps using downloaded installation files from your smartphones settings menu.

Using the BenQ Smart Control app

To begin using the **BenQ Smart Control** app:

1. Choose one of the following options:

- Connect your smartphone to the same wireless network as your projector.
- Enable wireless hotspot for your projector and then connect your smartphone to the projector's wireless hotspot. For instructions on how to enable wireless hotspot for your projector see [Hotspot on page 131](#).

 You must be connected to either the same wireless network as the projector or the projector's wireless hotspot for **BenQ Smart Control** to work correctly.

2. Open the **BenQ Smart Control** app  on your smartphone.

3. Select the projector from the **BenQ Smart Control** device list.

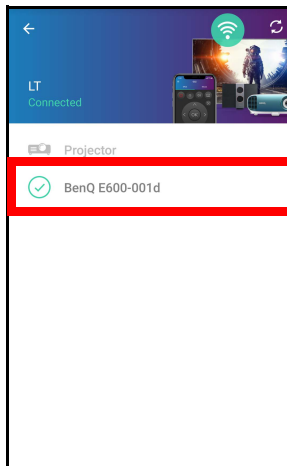

 The default name for the projector is "BenQ E600-xxxx" where the final four digits are the last four digits of its MAC Address.

4. Choose one of the following methods to use **BenQ Smart Control**:

- Tap **DPad** to use the pre-configured buttons in the app to control your projector.

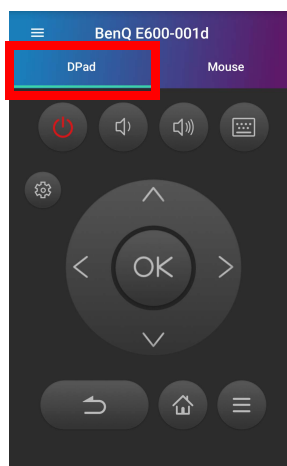

- Tap **Mouse** to use touch gestures on your smartphone to control the cursor on the projector similar to a mouse.

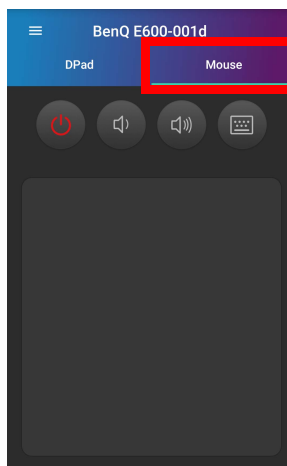

System Update

It is suggested that users regularly update their projector with the latest version of the firmware to optimize the user experience. The projector uses Over-the-Air (OTA) updates to install the update file wirelessly.

When a new version is available on the BenQ OTA server, a message will pop up once the projector is connected to a wireless network. Follow the steps below to begin updating the firmware:

1. Select **DOWNLOAD** to download the update file.

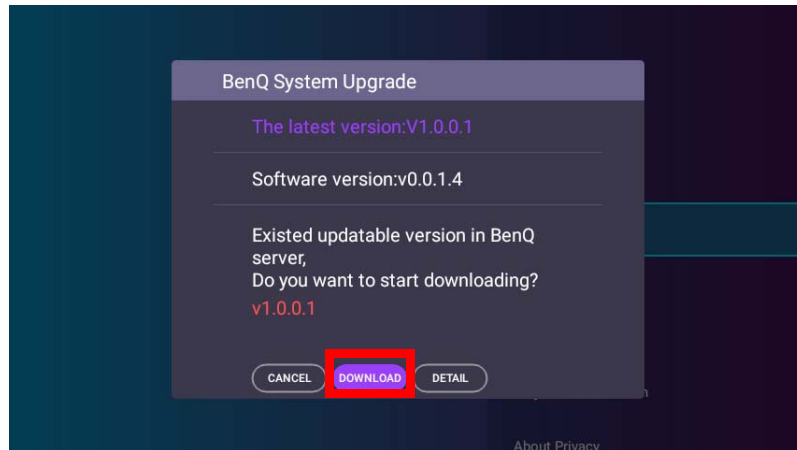

2. Once the download is completed, the projector will restart automatically. Do not turn off or unplug the projector before the projector is finished updating and **BenQ Launcher** reappears on the screen.

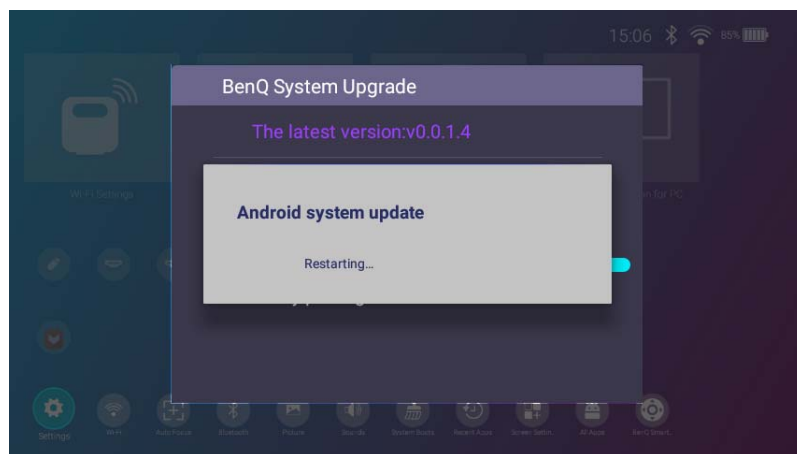

If you select **CANCEL** when the system upgrade message appears, a **System Update** button will appear in the settings menu of the **BenQ Launcher** home screen and feature a red dot as a reminder that a newer version of firmware is available on the BenQ OTA server. Users can select the **System Update** and press **OK** to upgrade the system at any time.

